



Displaced morphology in German verb clusters: an argument for post-syntactic morphology

Martin Salzmann¹

Received: 15 November 2017 / Accepted: 5 July 2018 / Published online: 20 March 2019

© Springer Nature B.V. 2019

Abstract

In this paper I will provide a new argument for post-syntactic morphology. The empirical evidence comes from so-called displaced morphology in German verb clusters, where the non-finite verb form selected by a given governor does not appear on the immediately dependent verb but rather on the linearly last verb of the selector's complement. The placement of the morphology thus partly depends on linear notions and not exclusively on hierarchical relations. I will provide an analysis within Distributed Morphology (Halle and Marantz in *The view from Building 20. Essays in linguistics in honour of Sylvain Bromberger*, MIT Press, Cambridge, MA, pp 111–176, 1993), where exponents for non-finite morphology are inserted into separate functional heads which are linearized after their VP-complements. At a late stage of the PF-derivation, the exponents are associated with their verbal hosts by means of Local Dislocation, an operation that applies under adjacency (Embick and Noyer in *Linguist Inq* 32(4):555–595, 2001). As a consequence, the non-finite morphology always comes last in the selector's complement. Displacement arises once the immediately dependent verb is not the last verbal element in the complement of its selector; this is generally the case in strictly ascending orders, while in the strictly descending 321 order the morphology is faithfully realized. The placement operation is thus always the same, displacement only emerges as a side effect of certain cluster orders. Further evidence for a post-syntactic approach to the placement of non-finite morphology and against a pre-syntactic perspective comes from the absence of semantic effects under displacement, the emergence of non-finite verb forms specified for more than one non-finite category under multiple displacement and the distribution of default forms.

Keywords Verb clusters · Post-syntactic morphology · Distributed Morphology · Morphological selection · Displaced morphology · IPP-effect · Participles · Infinitives · Local Dislocation · Adjacency · Haplology · Lowering · Cyclicity · West-Germanic · German dialects · Swiss German

✉ Martin Salzmann
martin.salzmann@uni-leipzig.de

¹ Department of Linguistics, Leipzig University, Beethovenstraße 15, 04107 Leipzig, Germany

1 Introduction: morphological selection

It is a general property of syntax that heads determine the formal properties of their complements. In this paper I focus on selection of non-finite morphology where several selection relations are involved. Canonically, the morphology selected by a verb V_n is realized on the directly subordinate verb V_{n+1} (if the non-finite morphology is selected by a noun/adjective/complementizer, it is realized on the highest verb below it). This is schematically represented in (1), which depicts a sequence of verbs that are in a government relation¹:



The non-finite morphology selected by V_1 is thus realized on V_2 , the morphology selected by V_2 on V_3 and so forth. The following example from English illustrates the workings of selection:

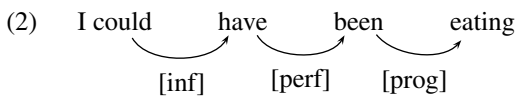

The modal verb *could* selects an infinitive, which is realized on the perfective auxiliary *have* that immediately depends on the modal. *Have* in turn selects a past participle, which is realized on the progressive auxiliary *been*. *Been*, finally, selects the progressive form, which is realized on the lexical verb *eating*.

Ensuring that the selectional properties of a governor are satisfied can be done either by means of a checking operation or by Agree between the selector and the dependent element. In the former, both elements are pre-specified for a certain value. If the values coincide, checking and thus selection is successful. In the latter, first adapted to morphological selection in Adger (2003) and later developed in Wurmbrand (2012), the dependent element starts out with an unvalued feature that is valued in the course of the derivation by the selector.

In this paper, I discuss a case of morphological selection which does not conform to the picture sketched above: In German (varieties), the non-finite morphology selected by V_n is not always realized on V_{n+1} but rather generally on the linearly last verb of the selector's complement. We thus instead find a pattern as in (3), where the non-finite morphology selected by V_1 is not realized on the directly dependent V_2 but rather on V_3 , the lowest element in the verbal hierarchy, so that it appears to be displaced (the fate of the selectional restrictions of the intermediate verb V_2 will be addressed in Sect. 5 below; in what follows, the arrows in the diagrams indicate morphological selection; dashed arrows indicate selection that involves displacement):



¹ In the traditional German literature, cf. Bech (1983), the selection of non-finite verb forms is called 'status-government'; verbs thus govern the 'status' of dependent verbs.

A concrete example is presented in (4), where V1 selects a past participle, while V2 selects an infinitive. Crucially, the participle morphology occurs on V3 rather than on V2 (cf. Behaghel 1923–1932, Volume 2, 369, §750)²:

- (4) ob in diu edele vrouwen het(e)₁ lazen₂ daz getan₃
if him the noble lady have.SBJV.3SG let.INF that do.PTCP
 ‘if the noble lady had let him do that’ *Middle High German*

I will argue that despite appearances this phenomenon does not involve any displacement operation as such but emerges as a side effect of certain cluster ordering possibilities. I will provide an analysis couched within the framework of Distributed Morphology (Halle and Marantz 1993), where morphological exponents are inserted after syntax and may be subject to various post-syntactic operations. Under this perspective, displacement follows from the assumption that the morphological exponents are inserted into separate syntactic heads and are placed at PF by means of Local Dislocation. Since the placement of the morphology thus applies very late in the PF-branch and is sensitive to linear order, it can be affected by earlier operations including those that are responsible for the different orders in the verb cluster. Foreshadowing the analysis to be presented in Sect. 3, in examples like (4), V1 selects an FP into whose head the participle morphology will be inserted. Since VP2 and VP3 are ordered after V1 in this variety but before F (a fact related to the head-finality of German), both verbs are linearized before the participial affix. By means of Local Dislocation, it is attached to the adjacent V3:

- (5) a. structure: [VP₁ V1 [FP [VP₂ V2 [VP₃ V3]] F]]
 b. linearization + vocabulary insertion: V1 V2 V3 ptcp
 c. placement: V1 V2 V3 ptcp → V1 V2 **ptcp**+V3
↑ LD ↓

Next to the fact that the placement of non-finite morphology is not solely governed by hierarchical relations but crucially affected by linear notions such as adjacency, two further aspects of the phenomenon provide arguments for post-syntactic morphology: First, displacement has no semantic effects. Second, the restrictions on displacement follow from the selectional properties of the vocabulary items, which are checked under linear adjacency. I will show that the placement facts follow straightforwardly under a derivational approach to morphological computation and thus the ordering of post-syntactic operations (cf. Embick and Noyer 2001; Arregi and Nevins 2012).

This paper is organized as follows: in Sect. 2, I will introduce the phenomenon of displacement. Section 3 provides a derivational account of the placement of non-finite morphology. In Sect. 4, I will show that displacement does not have any semantic effects. Section 5 is devoted to restrictions on displacement. In Sect. 6, I discuss the implications for morphological theory. In Sect. 7 I address instances of non-

² The glosses follow the Leipzig glossing rules, available at <https://www.eva.mpg.de/lingua/pdf/Glossing-Rules.pdf>. The numerical indices on the verbs indicate the hierarchical relations, i.e., 1 stands for the hierarchically highest verb of the relevant domain, 2 for the immediately dependent verb, etc.

Examples without reference have been constructed by the author. This includes the Swiss German examples, which are drawn from Zurich German, the author’s native language.

displacement, and Sect. 8 concludes. The “Appendix” briefly compares displaced morphology in German with parasitic participles in Frisian and Scandinavian; furthermore, it explores the prospects of a unified theory of morphological selection within Germanic involving a combination of hierarchy-based Agree with post-syntactic movement operations.

2 The phenomenon of displacement

One prominent feature of Continental West-Germanic OV-languages like Dutch and German is the clustering of verbal elements at the end of the clause in V-final structures, as in the following example (under verb second, where the finite verb moves to C, only the non-finite verbs occur together):

- (6) *dass er das Buch lesen₃ können₂ muss₁*
that he the book read.INF can.INF must.3SG
 ‘that he must be able to read the book’ *Standard German*

Such sequences are referred to as verb clusters (for an overview, cf. Wurmbrand 2017). They are restructuring constructions and involve the combination of a lexical verb with one or several functional verbs (modals, auxiliaries) and/or with lexical verbs selecting a non-finite complement. Furthermore, they are characterized by massive cross-linguistic/dialectal/inter-speaker variation with respect to the various orders of the verbal elements. Of the six logically possible orders in three-verb clusters, the existence of five orders is uncontroversial, viz., 321, 123, 132, 312 and 231, while the existence of the 213 order has been subject to much controversy; see Salzmann (2019) for a recent overview of the debate and new arguments that the 213 order does exist.

In this section, I will describe the workings of morphological selection in German verb clusters; I will first discuss the placement of the infinitival particle *zu* in the standard language and in the dialects before addressing placement of other non-finite forms.

2.1 Standard German descending verb clusters: well-behaved

Verb clusters in the standard language are mostly descending, viz., the governing verb follows the governed verb. Descending orders are unsurprising from the point of view of morphological selection since the non-finite morphology selected by a given verb is faithfully realized on the immediately dependent verb, as illustrated in (7):

- (7) a. *dass er das Buch gelesen₃ haben₂ muss₁*
that he the book read.PTCP have.INF must.3SG
 ‘that he must have read the book’ *321 Standard German*
- b. *dass er das Buch zu lesen₃ versucht₂ hat₁*
that he the book to read.INF try.PTCP have.3SG
 ‘that he tried to read the book’ *321 Standard German*
- c. *dass er das Buch nicht lesen₃ zu können₂ scheint₁*
that he the book not read.INF to can.INF seem.3SG
 ‘that he does not seem to be able to read the book’ *321 Std. G.*

- d. dass er das Buch **zu** lesen₃ **zu** versuchen₂ versprach₁
that he the book to read.INF to try.INF promise.PST.3SG
 ‘that he promised to try to read the book’ 321 *Standard German*

In (7a), V1 selects a bare infinitive, which is realized on V2; V2 in turn selects a past participle, which is realized on V3. In (7b), V1 selects a past participle, which is realized on V2; V2 selects a so-called *zu*-infinitive (an infinitival verb preceded by the particle *zu* ‘to’), which is realized on V3. In (7c), V1 selects a *zu*-infinitive, which is realized on V2. V2 selects a bare infinitive, which occurs on V3. In (7d), V1 selects a *zu*-infinitive, which is realized on V2. V2 also selects a *zu*-infinitive, which is realized on V3. The placement of the selected forms in descending order is schematically represented in (8):



It is uncontested that participial and bare infinitival exponents belong to morphology (they are affixes); the same holds for two further non-finite forms to be discussed below, the gerund and infinitives with a *ge*-prefix. The status of *zu*, however, is somewhat equivocal, in that it has both properties of affixes and clitics, as will become clear in the next sections. For the moment it suffices to know that *zu* is a dependent element that needs to attach to the left of a verb in the bare infinitive. I will in what follows subsume it under non-finite morphology, not the least because it patterns like the other categories with respect to displacement. I will return to the status of *zu* in Sect. 5.1.

2.2 Standard German (partially) ascending clusters: displaced *zu*

Interestingly, once the cluster order deviates from the strictly descending 321-order, i.e., involves a (partially) ascending order, the transparent pattern of the previous subsection changes. While nothing special happens with bare infinitives and participles, *zu*-placement is no longer in accordance with the hierarchical relations. Consider the triple in (9) where the complementizer *ohne* ‘without’ selects a *zu*-infinitive (*zu*-selectors will henceforth be underlined)³:

- (9) a. ohne das Buch lesen₃ gekonnt₂ **zu** haben₁
without the book read.INF can.PTCP to have.INF
 ‘without having been able to read the book’ 321 *Standard German*
- b. ohne das Buch haben₁ lesen₃ **zu** können₂
without the book have.INF read.INF to can.INF
 ‘without having been able to read the book’ 132 *Standard German*
- c. ohne das Buch lesen₃ haben₁ **zu** können₂
without the book read.INF have.INF to can.INF
 ‘without having been able to read the book’ 312 *Standard German*

³ Note that while V2 occurs as a participle in (9a), it appears as a bare infinitive in (9b/c). This instantiates the so-called IPP-effect, cf. Sect. 5.2 below for discussion. Some speakers prefer the participle morphology to appear on V3 in (9c), instantiating the so-called scandal construction (cf. Vogel 2009, who coined the term, for details as well as the discussion in Sect. 2.6 below).

In (9a), which involves a 321-order, the *zu*-infinitive appears on the hierarchically highest verb of the cluster, viz., V1, as one expects. In (9b/c), however, which involve a 132 and 312 order, respectively, *zu* does not occur on V1 but rather on V2. It thus seems to be displaced. As an initial generalization: When selected by an element outside the verb cluster, *zu* attaches to the last verb of the cluster, irrespective of the hierarchical relationships. In a configuration as in (9) displacement thus occurs once V1 is not cluster-final, i.e., in all orders except 321 and 231. Crucially, if *zu* occurs on V1 or on V3 in (9b/c), the result is sharply ungrammatical, as (10) shows for (9b)⁴:

- (10) ohne das Buch {***zu**} haben₁ {***zu**} lesen₃ {zu} können₂
without the book to have.INF to read.INF to can.INF
 ‘without having been able to read the book’ 132 *Standard German*

Importantly, displacement is a property of verb clusters/Verb Projection Raising (for the latter, see Salzmann 2019); in the 3rd Construction, a restructuring construction where the dependent *zu*-infinitive follows the governing verb, there is no displacement. Rather, the *z(u)* selected by the matrix verb (*raten* ‘advise’ in (11)) appears on V1 (since V1 also selects a *zu*-infinitive, there is another *zu* on V2; pronoun fronting indicates restructuring):

- (11) ... würd ich dir raten ihn₁ *(**zu**) versuchen₁ t_{ihn} zu
would.ISG I you.DAT advise.INF him to try.INF to
 überzeugen₂
convince.INF
 ‘I would advise you to try to convince him.’ *Std./Coll. German*
<https://www.gutefrage.net/frage/pole-dance-ohne-einverstaendnis-vom-freund>, accessed
 September 5, 2018

Displaced *zu* has been frowned upon by grammarians ever since Grimm (1837, 949). There seem to be two reasons: First, displacement is considered illogical as it blatantly violates the canonical rule of morphological selection; second, native speakers show a significant degree of uncertainty and variability in empirical tests according to Reis (1979) and Haider (2011) (one should add, though, that their claims are not based on data obtained by modern experimental techniques). As for the first point, German is often compared with the well-behaved Dutch verb clusters, where the equivalent particle *te* always occurs on the hierarchically highest verb (for *te*-placement in Dutch, see Sect. 7.1):

⁴ Displacement is also found in ascending attributive present participle clusters:

- (i) der das Buch haben₁ lesen₃ woll₂-ende Schüler
the the book have.INF read.INF want-PTCP pupil
 ‘the pupil who wanted to read the book’ *Standard German*

The distribution is exactly the same as with *zu*: The participial ending attaches to the last verb of the participial cluster, which entails displacement if a verb other than V1 comes last. The analysis to be presented in Sect. 3 below can also be applied to examples like (i); like *zu*, the participial ending will be inserted into a separate functional head that is linearized after the verb cluster and is attached to the adjacent verb by Local Dislocation.

- (12) zonder het boek **te** moeten₁ kunnen₂ lezen₃
without the book to must.INF can.INF read.INF
 ‘without having to be able to read the book’ 123 *Standard Dutch*

Since displacement violates a rule of grammar, it is considered ungrammatical by Merkes (1895) and Haider (2011). Both argue that the existence of displacement may be motivated by the fact that *zu* generally occurs at the end of the verb cluster. Displacement may then be an over-generalization. Haider (2011) argues that it is a grammatical illusion: Although the construction is acceptable to many speakers, it is nevertheless ungrammatical. Bech (1963) considers the construction grammatical, but argues that it is a hybrid repair phenomenon that results from the fact that two equal rules are in conflict with each other, viz., that (i) *zu* must occur on the immediately depending verb and (ii) at the end of the verb cluster. Given that this conflict cannot be resolved in 132 and 312 orders, the degradedness of the result may thus be unsurprising. Reis (1979), finally, argues that the grammatical status of the construction is undefined: She proposes that grammatical rules are only defined for the standard cases and may consequently not apply in very specific environments such as the one where displacement is found.

Following Meurers (2000) and Vogel (2009), I assume instead that displacement is a grammatical phenomenon. I will show that the picture changes drastically once the rule for the placement of non-finite morphology in German is reconsidered. There will be just one placement rule in my analysis so that no conflicts arise; both lack of displacement in descending orders and displacement in orders that deviate from 321 will result from the very same rule and both thus arise as the only logical possibility in their respective grammatical environments. The theory-internal arguments against the grammatical status of displacement adduced in the works cited above thus disappear. Nor will there be any reason to consider displacement as either a repair phenomenon or as a construction outside the purview of grammatical rules.

Quite apart from the conceptual argument, there are also strong empirical arguments against treating displacement as ungrammatical/para-grammatical/hybrid: First, this fails to account for the significant contrast between the displaced variant in (9b) and the versions without displacement in (10). Second, displacement is attested in careful sources, including poetic and scientific texts as well as in prestigious newspapers as in (13) (for more examples see Merkes 1895, 69f.; Behaghel 1923–1932, volume 2, 308f.; Meurers 2000, 72, ex. 114; for examples from Early New High German, cf. Ebert et al. 1993, 397, §179):

- (13) die Ohnmacht, nicht haben₁ helfen₃ **zu** können₂ ...
the powerlessness not have.INF help.INF to can.INF
 ‘the powerlessness not having been able to help’ FAZ, 03. 01. 2005

Displaced *zu* can also be found in large corpora such as the DWDS- and the COSMASII-corpus; a search returned 11 hits for the COSMASII- (winter 2018) and 38 hits for the DWDS-corpus (spring 2017).⁵ Third, displaced *zu* is unmarked in German

⁵ For more information about the corpora, see <https://www.dwds.de/> and <http://www1.ids-mannheim.de/kl/projekte/korpora.html>.

dialects (see Sect. 2.3), and fourth, displaced *zu* is part of a more general displacement phenomenon (see Sect. 2.4).

2.3 Displaced *zu* in German dialects

Displaced *zu* is necessarily infrequent in the standard language because (partially) ascending orders only occur in three-verb clusters, and among those only in one cluster type (Aux/Fut-Mod-Inf). This may help explain why some speakers perceive the construction as marked.

The situation in dialects is very different because ascending orders are much more prominent and often constitute the default (at least in Central and Upper German dialects); this crucially includes the much more frequent two-verb clusters. Consequently, displacement is expected to occur more often than in the standard language. Indeed, the phenomenon is well-attested in the literature and crucially there is no indication that it is a marked or ungrammatical phenomenon. Rather, displaced *zu* is described as the canonical realization of non-finite morphology in (partially) ascending orders, i.e., it is obligatory. Its grammaticality is thus undisputed.

The dialectal data in this and later sections will mainly be drawn from Alemannic and Thuringian dialects (the latter being East Central German or East Franconian varieties). This is simply due to the fact that displacement has been explicitly described for these varieties and, in the case of Alemannic (especially Swiss) varieties, is well-attested in the modern dialect. But in principle I expect *zu*-placement to work analogously in other German dialects. Two further recently discovered patterns of *zu*-placement will be briefly addressed in Sect. 2.6.

Importantly, the consensus about the grammaticality of displacement holds for both traditional grammars (Hodler 1969, 560; Weber 1987, 244; and especially the works cited in Höhle 2006), more descriptive treatments (Comrie and Frauenfelder 1992) as well as formal approaches (Bader 1995, 22; Cooper 1995, 188f.). Furthermore, displaced *zu* can be heard on the (Swiss) radio (Cooper 1995) and be found on the internet.

The following examples are but a small selection. The first set involves cases where *zu* (*z* in Swiss German) is selected by a non-verbal element (noun, adjective, complementizer) that governs the verb cluster. (14c) is from Comrie and Frauenfelder (1992, 1059); (14d/e) illustrate *z*-placement in the orders 231 and 213⁶:

- (14) a. Ich liebe d freiheit, selber de tag chöne₁ z bestimme₂.
I love.ISG the freedom self the day can.INF to determine.INF
 'I love the freedom to determine my schedule.' 12 Swiss G.
<http://badoo.com/de-ch/0279246484/>, accessed March 11, 2013

⁶ As in the standard language, there is displacement in 132 and 312 orders and faithful realization in the 321 order (to the extent that this order is available). In all the examples, the verb selecting the lexical verb (V1 in a–c, V2 in d–e) governs the bare infinitive.

Note that since 231 orders are marked in Swiss German (they only occur with motion verbs, cf. Salzmann 2013a, and benefactives, inchoatives and perception verbs, cf. Lötscher 1978, 3, fn. 2; Schmid 2005; Salzmann 2019), embedding them under a *zu*-selector will further increase the markedness of such examples. Since some speakers allow a *zu*-infinitive with 'begin', (14e) might also be an instance of the missing-*z* construction discussed in Sect. 5.3.1 below.

- b. bin [...] trurig [...] die liebe Lüüt hinder mir müese₁ **z'** loh₂
am sad the nice people behind me must.INF to let.INF
 'I am sad having to leave these lovely people behind.' 12 Swiss G.
<http://melanie-underwegs.blogspot.com>, accessed September 5, 2018
- c. Ech ha ts Büach kchöiff, fer dam Marco cheni₁
I have.ISG the book buy.PTCP for the.DAT Marco can.INF
z sägan₂, ...
to say.GER
 'I bought the book to be able to tell Marco ...' 12 *Bosco Gurin*
- d. d Froid, di ghööre₂/ghöört₂ singe₃ **z** haa₁
the joy you hear.INF/hear.PTCP sing.INF to have.INF
 'the joy to have heard you sing' 231 Swiss G.
- e. Wieder en grund meh zum glücklich drüber sii, niä agfange₂
again a reason more to happy about.it be.INF never begin.PTCP
 ha₁ **z** rauche₃!
have.INF to smoke.INF
 'Another reason to be happy to have never started smoking!' 213 Sw. G.
<https://www.facebook.com/Radio24/posts/10151574652070814>, accessed March 28, 2016

As in the Standard German cases discussed above, when selected by an element outside the cluster, $z(u)$ attaches to the last verb of the verb cluster, which entails displacement in the orders 12(3), 132, 312 and 213.

I now turn to examples where the non-finite morphology originates within the cluster, i.e., where the zu -selector is V1. There is no displacement in 321, 132 and 312 orders; in these orders, zu is faithfully realized on V2. The 321 order displays the same pattern as in Standard German, cf. ex. (7c). The following pair provides 132- and 312 examples from Swiss German (since zu -selecting verbs do not frequently occur in these orders in Swiss German, such examples will invariably be somewhat marked; but there can be no doubt about the proper placement of zu ; pronoun fronting indicates restructuring).⁷

- (15) a. dass er si schiint₁ hürate₃ z wele₂
that he her seem.3SG marry.INF to want.INF
 'that he seems to want to marry her' 132 Swiss German

⁷ Swiss German constructions with zu -infinitives behave like proper verb clusters and not like the 3rd Construction, even in 123 and 132 orders, cf. Sect. 5.3.1 below and Salzmann (2019). Comparable Standard German examples are given in (i):

- (i) a. dass er [...] sein eigenes mattes Image aufpolieren₃ glaubt₁ zu müssen₂
that he his own dim image polish.INF believe.3SG zu must.INF
 'that he believes he has to polish his dim image' *Standard German*
<http://www.suedwatch.de/blog/?p=2139>, accessed November 1, 2017
- b. Dass der Schwachkopf [...] glaubt₁, antworten₃ zu müssen₂!
that the idiot believe.3SG answer.INF to must.INF
 'That the idiot believes he should react [to such an insult].'
Standard German
<http://www.rationalgalerie.de/kritik/wer-sind-springers-erben.html>, accessed November 1, 2017

- b. dass er si hürate₃ schiiint₁ z wele₂
that he her marry.INF seem.3SG to want.INF
 ‘that he seems to want to marry her’ 312 *Swiss German*

In the other orders, we find displacement. The following pair illustrates displacement under a strictly ascending order; (16a) is from Weber (1987, 244, fn.1) and (16b) is from Weise (1900, 154):

- (16) a. Er schiiint₁ nüüt wele₂ z wüsse₃ dervoo.
He seem.3SG nothing want.INF to know.INF about.it
 ‘He does not seem to be interested in it.’ 1 ... 23 *Zurich G.*
- b. weil er sich nicht von ihm braucht₁ lassen₂ anzuschauen₃
because he self not by him need.3SG let.INF rant.at.INF
 ‘because he does not need to be ranted at by him’ 123 *Altenburg*

Examples with 231 and 213 order are difficult to construct since *zu*-selecting verbs usually do not occur in these orders in Swiss German and German dialects more generally. While the following examples are thus degraded because of the cluster order, there is no doubt that *z* has to be displaced to V3 (cf. ex. (21) below for an attested example in 213 order with displacement):

- (17) a. %dass er si {*z} ghööre₂ {✓z} lache₃ schiiint₁
that he her to hear.INF to laugh seem.3SG
 ‘that he seems to hear her laugh’ 231 *Swiss German*
- b. %dass er si {*z} ghööre₂ schiiint₁ {✓z} lache₃
that he her to hear.INF seem.3SG to laugh.INF
 ‘that he seems to hear her laugh’ 213 *Swiss German*

As mentioned above, displacement is unmarked in the dialects. There are two factors that lead to its unmarked status and thus higher acceptability than in the standard language: First, since ascending clusters are much more prominent in dialects, including

Footnote 7 continued

However, at least in the 132 order it is not a priori clear whether this represents a proper verb cluster or rather an instance of the 3rd Construction (as claimed by Meurers 2000, 221f.). Given that such 132 clusters can also occur in 1243 order when embedded by an infinitive-selecting auxiliary with V2 thus in the upper-field, nothing speaks against treating them as proper verb clusters (in the 3rd Construction, which is a possibility as well, V2 would be located in the right sentence bracket preceding V1, with VP3 extraposed, resulting in 2143):

- (ii) in der wie jedes Jahr eine Reihe von Mandataren wird₁ glauben₂ beweisen₄ zu
in which like every year a number of representatives will.3SG believe.INF prove.INF to
 müssen₃, dass ...
must.INF that
 ‘in which a number of representatives will believe they have to prove that ...’ *Std. German*
 Tiroler Tageszeitung, 04.12.1997, Ressort: Regional Innsbruck und Umgebung; Eine beschlossene Sache;
 I97/DEZ.47824 (COSMASII, accessed November 9, 2017)

The displacement test that generally distinguishes between verb clusters and the 3rd Construction (recall example (11) above) is somewhat difficult to apply here as the cluster becomes relatively complex and a *zu* would go missing; see footnote 22 below for some discussion.

two-verb clusters, displacement is much more frequent than in the standard language where they only occur in one type of three-verb cluster. Second, because of the higher frequency of strictly ascending orders in dialects (12, 123), the relative dependencies between the verbs can be determined more easily than in the mixed clusters (132, 312) that prevail in the standard language: In the relevant 13*zu*2- and 31*zu*2-clusters, all verbs appear as infinitives so that it is not immediately obvious which verb depends on which (cf. Wurmbrand 2013). The dialect speaker, however, takes an ascending order for granted and will thus be able to determine the hierarchical relationships quickly despite the lack of morphological clues.

To summarize the empirical situation so far, a *z(u)* selected by an element outside the verb cluster always attaches to the last verb of the verb cluster. As a consequence, *z(u)* will appear displaced once V1 is not cluster-final. If *zu* is selected by V1, we find displacement in the orders 123, 231 and 213.

2.4 Further types of displaced morphology in German (dialects)

Importantly, displaced *zu* is not an isolated case. Rather, displacement is a more general phenomenon in that it occurs with various non-finite forms in German varieties. In principle, displacement will always take place if the context is given. However, as will be discussed in Sect. 5, since displacement can lead to morphological conflicts, it is sometimes blocked or becomes invisible.

Displacement of participle morphology is found in the so-called Participium Pro Infinitivo (PPI)-construction that was found in earlier stages of the language. In the Middle High German example in (18) (from Behaghel 1923–1932, Volume 2, 369, §750, repeated from (4)), V1 selects a past participle, but V2 appears as an infinitive, while V3 (which should be an infinitive given the selectional requirements of V2) appears as a participle⁸:

- (18) ob in diu edele vrouwen het(e)₁ lazen₂ daz getan₃
if him the noble lady have.SBJV.3SG let.INF that do.PTCP
 'if the noble lady had let him do that' *MHG, Nibelungenlied 634,2*

Displacement is particularly prominent in Thuringian dialects, which have a richer inventory of non-finite forms (cf. Höhle 2006). While some functional verbs select the bare infinitive (which is usually identical to the stem), certain modals/auxiliaries select infinitives with a *ge*-prefix (a form that also occurs in earlier stages of the language, see Jäger 2018) or gerunds (a long infinitive that partly goes back to the inflected form of the infinitive and partly to a present participle), all of which can be displaced. In (19a), V1 selects a *ge*-infinitive. However, V2 (which selects a bare infinitive) occurs as a bare infinitive, while V3 appears in the *ge*-infinitive; in (19b), V1 selects a gerund; crucially, V2, which selects a bare infinitive itself, occurs in the bare infinitive, while the gerund ending appears on V3 (Höhle 2006, 68, ex. 38, 39):

⁸ The PPI-construction is also residually found in some contemporary dialects, see e.g., Steil (1989, 41) and Heilmann (1999, 63, ex. 3h) and references cited there on Swabian clusters with V2 = 'help'. See also Höhle (2006, 66, fn. 19) for a PPI-example from Wasungen. For PPI in Afrikaans, cf. De Vos (2003, 522).

- (19) a. kãsd₁ mə heləf₂ gə-schri:₃
can.2SG me.DAT help.INF GE-write.INF
 ‘Can you help me write?’ 123 Kleinschmalkalden
- b. ə wyəd₁=s fʊnd lås₂ max-ə₃
he will.3SG=it indeed let.INF do-GER
 ‘He will have it done.’ 123 Kleinschmalkalden

The distributional pattern of these other non-finite forms is exactly the same as with *zu*: There is displacement in strictly ascending clusters from V1 to the final verb of the cluster as in (18), (19). There is no displacement from V1 in the orders 132 and 312 as the following examples show ((20a), where V1 selects a gerund and V2 a *ge*-infinitive, is from Höhle 2006, 72, ex. 54ii; (20b), where V1 selects a *ge*-infinitive, is from Steube 1995, 432; for another example with a 132 order with V1 selecting a *ge*-infinitive, see Sperschneider 1959, 43; the same can also be seen in the more complex examples from Barchfeld with 1243/1423 order discussed in Höhle 2006, 73, ex. 56iii, where the *ge*-infinitive selected by V2 is realized on V3 and the participle selected by V3 on V4):

- (20) a. a weAd₁=s ne: gə-mãx₃ khün-Λ₂
he will.3SG=it not GE-do.INF can-GER
 ‘He won’t be able to do it.’ 132 Steinach
- b. öb hä: dã:s wœrglich gəsœ:d₃ kon₁ gə-hã:₂
if he that really say.PTCP can.3SG GE-have.INF
 ‘if he really can have said that’ 312 Steinbach-Hallenberg

I do not have any information about the placement facts in the 321 order; I suspect, though, that the dialects that feature these special infinitives do not allow this order so that this cannot be tested. Clusters with 231 order are also rare in German varieties. The only example with displacement in this order that I am aware of is a PPI-case in Swabian (the participle morphology selected by V1 occurs on V3), cf. Heilmann (1999, 63, ex. 3f); there are also instances of PPI in Afrikaans in the 231 order, cf. De Vos (2003, 522). Clusters in 213 order with displacement from V1 to V3 are somewhat easier to find. A PPI-example is attested in Swabian, cf. Heilmann (1999, 62, ex. 3d). In the following example where the 213 cluster is part of a four-verb cluster (thus instantiating a 1...324 cluster), V2 selects a *ge*-infinitive which is realized on V4 (while V3 appears in the bare infinitive), cf. Höhle (2006, 74, ex. 59ii):

- (21) iç hdâu₁=s=nΛ los₃ khun₂ gə-max₄
I have.ISG=it=him let.INF can.INF GE-do.INF
 ‘I have been able to make him do it.’ 1...324 Steinach

If the non-finite morphology is selected by V1, displacement thus obtains in the orders 123, 213 (and possibly 231).

2.5 Summary

We have seen that the order in the German verb cluster has an effect on the placement of non-finite morphology. In strictly descending (321) orders, the selectional requirements of a given verb/adjective/noun/complementizer are always satisfied on the immediately dependent verb, cf. (22). Importantly, there is never any displacement in such orders, cf. (23):



Things are different in those orders that deviate from the strict 321 order. If the selector of non-finite morphology is outside of the verb cluster, the generalization is very simple: The non-finite morphology attaches to the last verb of the cluster. This implies displacement whenever V1 is not cluster-final:

(24) *selector outside the cluster*: displacement in 123, 132, 312, 213

Displacement in 12(3) and 312 orders is illustrated in (25) and (26):

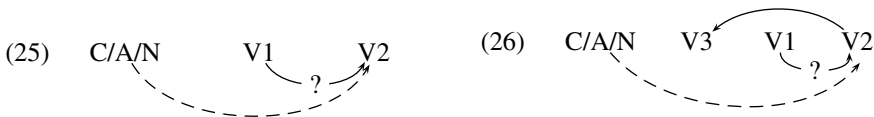

Note that displacement affects the selectional restrictions of the verbs that are in the middle of the government sequence (i.e., V1 in (25) and (26)). I will discuss the consequences in Sect. 5 below.

When the non-finite morphology is selected by a verb within the cluster, viz., V1, the pattern seems to be different at first sight: Unsurprisingly, non-finite morphology is faithfully realized in 321 orders. Interestingly, it is also well-behaved in 312 and 132 orders (where there is displacement if the selector is outside the cluster). Displacement, however, is found in the remaining orders:

(27) *non-finite morphology selected by V1*: displacement in 123, 231, 213

Displacement in 123 and 213 orders is illustrated in (28) and (29):



So far there does not seem to be a clear generalization for the placement if the morphology is selected by V1: in 123, 132, 312 and 213 orders, the morphology occurs on the last verb of the cluster, but in the 321 and 231 orders a different pattern obtains.

I will show below that all placement facts involving non-finite morphology can be unified with the following very simple generalization⁹:

- (30) *Placement of non-finite morphology*
The non-finite morphology selected by a head X occurs on the last verb of the complement of X.

The placement of non-finite morphology in German thus follows a very simple and general rule. What is remarkable is that it is not exclusively governed by hierarchical notions but is crucially affected by linear order. I will show in the next sections how the placement can be captured and what it implies for theories of verb clusters and for morphological theory. Before that I will briefly discuss two cases of displacement in German that follow a different pattern.¹⁰

2.6 Other displacement patterns

The so-called *Skandalkonstruktion* ‘scandal construction’ was first mentioned in Merkes (1895, 72), rediscovered in Reis (1979) and discussed in detail in Vogel (2009). In this construction, which obtains in 312 (and 1423) orders, the selectional requirements of the perfective auxiliary V1 are displaced to V3 (or from V2 to V4). Crucially, displacement thus does not target the last verb of the complement of the selector but rather the verb left-adjacent to V1. In (31), the past participle selected by V1 occurs on V3, see Vogel (2009, 308) (note that the *zu* selected by the matrix verb *bedauern* ‘regret’ undergoes regular displacement to the last verb of the cluster, viz., V2):

- (31) Er bedauert, es nicht verhindert₃ haben₁ **zu** können₂.
He regret.3SG it not prevent.PTCP have.INF to can.INF
‘He regrets not having been able to prevent it.’ 312 *Standard German*

Obviously, displacement of participial morphology in the scandal construction deviates from the general placement rule established above that the morphology selected by X (the auxiliary in (31)) attaches to the last verb of the complement of X, which would be V2 rather than V3 in (31). I will therefore set the scandal construction aside in the rest of the paper. It is not my intention to brush it under the carpet, not the least because Vogel (2009) provides evidence that the scandal construction is not just a marginal phenomenon (it can, e.g., be found in corpora, cf. also Wurmbrand 2013, but see Haider 2011 for a critical assessment). Rather, given the systematic placement differences, I believe it is misguided to attempt to unify the scandal construction with the instances of displacement that target the last verb of the complement of the selector. Consequently, the necessary mechanisms to derive the scandal construction will be rather different, see e.g., Vogel (2009) and Wurmbrand (2012) for relevant proposals. An alternative view is proposed in Meurers (2000, 96ff.), taking up an observation by Merkes (1895, 33f.): He argues that the scandal construction should be considered a

⁹ The generalization in (30) also holds if the non-finite morphology is selected by V2. For obvious reasons, displacement can only be observed in four-verb clusters. Thus, there is displacement in 1234 orders but not in 1243 orders. Ex. (21) shows displacement from V2 to V4 in a 1324 order.

¹⁰ Another phenomenon that seems related to displaced morphology is parasitic participles in Norwegian/Swedish/Faroese and Frisian; see the “Appendix” in Sect. 1.

residue of a construction that was more prominent in Middle High German (cf. Jäger 2018); this construction shows a systematic syntax-semantics mismatch: In three-verb clusters with the perfective auxiliary semantically as V1 and the modal as V2, the modal appears syntactically as V1 and the perfective auxiliary as V2 (basically as in English *should have left*). The scandal construction can then be reanalyzed as a 321 cluster where morphological selection is regular. I will not choose between these options and leave the issue for future research.

Schallert (2019a) has recently drawn attention to hitherto neglected patterns of *zu*-placement: He provides three examples from Alemannic, Southern Bavarian and Low German as well as two examples from the internet where *zu* occurs displaced to the left in a descending verb cluster, thus, on V2 instead of V1, leading to *zu21*. In addition, he reports two instances of *zu*-doubling, from the dialect of Frankfurt and the urban dialect of Berlin, where in descending clusters *zu* is correctly placed on V1 but additionally occurs on V2 as well, leading to *zu2zu1* (a few such examples can also be found on the internet). Because of their rarity one may be inclined to treat these examples as production errors, but as Schallert points out, next to the dialectal attestations, at least the first pattern without doubling can also be found in earlier stages of the language, cf. Behaghel (1923–1932, 308) and Ebert et al. (1993, 397, §179). Additional evidence for the viability of these patterns may come from the fact that similar patterns can be found in Flemish and Afrikaans (*te* before the verb cluster) and Dutch dialects (*te*-doubling and -lowering), cf. Sect. 7.1 below. Eric Hoekstra (p.c.) pointed out to me that in Frisian (descending clusters) *te*-doubling occurs as well. Given the scarcity of information about these placements, I will refrain from speculating about possible analyses, although a treatment similar to that for Afrikaans and Dutch dialects may be an option (cf. 7.1). For a concrete proposal, see Schallert (2019a).

3 The derivation of displaced morphology

The basic idea underlying the placement of non-finite morphology is very simple: Adopting a Distributed Morphology architecture (Halle and Marantz 1993), the non-finite morphology is inserted into independent syntactic heads and is associated with its host post-syntactically by means of Local Dislocation, an operation that applies to linear structure and is constrained by adjacency (Embick and Noyer 2001; cf. also Hinterhölzl 2009, 2018). Concretely, there are separate functional heads F that host the features corresponding to *zu* (cf. Den Dikken and Hoekstra 1997, 1062) and the other non-finite categories (past participle, gerund, (*ge*-)infinitive). These functional heads occur above VP. Morphological selection is thus checked in syntax: A complementizer/V1 that takes a *zu*-infinitive is syntactically combined with an FP hosting the relevant syntactic features (given a post-syntactic approach to morphology, the exponents are inserted late). For my purposes the correct result obtains irrespective of whether this involves checking between C/V and F or if F starts out with unvalued features and is valued by the governing verb/complementizer (as in Adger 2003; Wurmbrand 2012). The functional heads hosting inflectional information take their

VP-complement to the left, in accordance with the head-final nature of the German VP.¹¹ As a consequence, the non-finite morphology always comes last in the complement of the selector. This captures the generalization that the non-finite exponents always attach onto the last verb in the complement of their selector. The mechanism that associates the morphology with its host is thus always the same, but since Local Dislocation applies to linear structure, it can have very different effects, depending on the order in the verb cluster: If the order is strictly descending (viz., (3)21), the morphology appears to be well-behaved. If, however, the immediately dependent verb does not occur last in the selector's complement, the non-finite morphology will appear to be displaced. Crucially, however, there is thus no displacement operation as such; rather, displacement is only a side effect.

I make the following assumptions about verb clusters: First, the coherence/restructuring effects are due to the fact that the relevant verbal projections contain less structure, viz., lack a CP- (and possibly a TP-) layer, cf., e.g., Wurmbrand (2007). In what follows, I will label all verbal projections as VPs for ease of readability even though they may slightly differ in size (i.e., corresponding to VP/vP/TP) and some may better be classified as functional (cf. Wurmbrand 2004b). Second, I assume that the various orders that can be observed in verb clusters are largely a matter of PF, i.e., are determined by linearization parameters, cf. Bader and Schmid (2009) and Abels (2016) (and, probably, Schmid and Vogel 2004) or explicit PF-operations such as VP-inversion/flip (Haegeman and van Riemsdijk 1986; Williams 2004; Wurmbrand 2004a, c) or Local Dislocation (cf. Salzmann 2013a). For reasons of simplicity, I will in what follows treat the orders 123, 132, 231 and 321 as arising through flexible linearization between head and complement, but a derivational perspective where one order is basic and the others are derived from it by means of additional PF-operations would also work for my purposes. The 312 and the 213 order require additional operations, as discussed below. For a comparison of left-branching and right-branching accounts, see Salzmann (2013b), for a discussion of alternative ways of deriving the different cluster orders, cf. Salzmann (2019); for XP/remnant movement-based approaches, see also Sect. 4 below.

I will now go through the derivations for the placement of non-finite morphology. I will first discuss non-finite morphology that originates outside the cluster (i.e., is selected by N/A/C) before addressing the placement of non-finite morphology selected within the cluster.

I will start with Standard German Aux-Mod-Inf clusters involving both 'well-behaved' 321 cases like (9a) as well as examples with displacement such as (9b) and (9c). I repeat them for convenience:

¹¹ F thus differs from other functional heads in the language, viz., C and D, which precede their complement. However, since F is essentially an inflectional/agreement head and thus belongs to a different section of the clausal spine than C and D, I take this to be unproblematic. Evidence for further functional heads in the clausal domain like *v* and T is scarce given that they do not seem to be targeted by verbs in a final movement step (Haider 2010).

- (32) ohne das Buch {lesen₃ gekonnt₂ **zu** haben₁ | haben₁ lesen₃ **zu** können₂}
without the book read.INF can.PTCP to have.INF have.INF read.INF to
können₂}
can.INF
 ‘without having been able to read the book’ 321/132 Standard G.

In Standard German, Aux-Mod-Inf clusters occur in either a strictly left-branching (321) order where the VP-complements are ordered before the governing Vs, cf. (33), or in a mixed (132) order, cf. (34), where VP2 is ordered after V1, while VP3 is ordered before V2 (the boxed verb is the one whose position is crucial; for simplicity’s sake, I represent the features corresponding to *zu* as [zu])¹²:

(33) Aux-Mod-Inf 321:

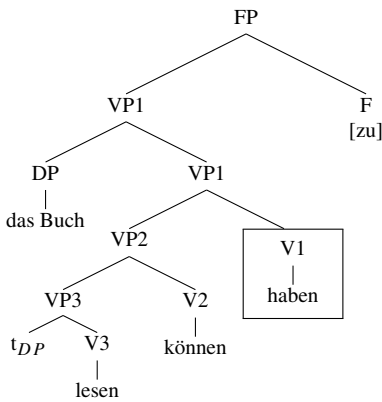

(34) Aux-Mod-Inf 132:

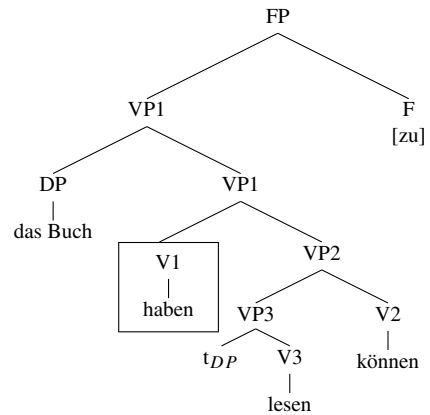

At vocabulary insertion, the hierarchical structures are converted into a linear string. *Zu* is thus inserted into F. Importantly, *zu* is a dependent element that needs to attach to the left of its host, a verb in the infinitive. This triggers Local Dislocation, by which it is affixed onto and inverted with the closest, i.e., linearly adjacent verbal element. The operation is thus Vocabulary-sensitive (cf. Embick and Noyer 2001, 566; Kramer 2010).¹³

Depending on the linearization, this will target different verbs: In (33), *zu* will attach to V1 and thus derives the ‘well-behaved’ case in (9a) above, as illustrated in (35a). In (34), however, *zu* attaches to V2, which is the adjacent verb in this derivation, leading to displacement, as illustrated in (35b):

¹² If non-verbal material is not scrambled out of the lexical VP, Verb Projection Raising arises, see Salzmann (2019). For a base-generation alternative to scrambling in such configurations, see Salzmann (2011). In the tree diagrams in the text, scrambled material is located in a specifier of V1; a specifier of F would be a possible landing site as well; since the two options are difficult to tease apart, I will not dwell on this.

¹³ Note that for ease of representation I have omitted the functional projection hosting the features of the participle selected by V1 in (33) and (34). In (33) this head would also be linearized after its VP-complement, viz., VP2, so that the participle attaches to V2, resulting in (9a). In the 132 order in (34), V2 regularly appears in the infinitive rather than as a participle, instantiating the IPP-effect. Projections for infinitive morphology have also been omitted. See Sects. 5.1 and 5.2 below for discussion of the infinitive and the IPP-effect.

4 Absence of semantic effects

Displaced morphology is crucially not interpreted in its surface position. This can be shown with the PPI-construction, repeated from (18):

- (48) ob in diu edele vrouwen het(e)₁ lazen₂ daz getan₃
if him the noble lady have.SBJV.3SG let.INF that do.PTCP
 ‘if the noble lady had let him do that’ *MHG, Nibelungenlied 634,2*

Although the participle morphology occurs on V3, it semantically applies to VP2. This follows straightforwardly under the post-syntactic approach pursued here: At spell-out, which forms the input to LF, the features realized by the participle are located in an FP above VP2 and thus will be interpreted in the correct position, cf. (49) (I henceforth represent the features realized by the past participle simply as [ptcp], thereby remaining agnostic as to the precise semantic contribution). Crucially, Local Dislocation at PF does not have any effect on the interpretation (this argument presupposes that the participle contributes to the meaning of the present perfect, cf. Wurmbrand 2004a):

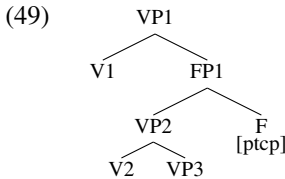

In approaches where displacement is derived by means of syntactic operations as in antisymmetric XP-movement approaches, serious problems arise for semantic interpretation: For an F-head hosting features like [ptcp] to occur at the end of (part of) the cluster, the relevant part of the cluster has to be moved into its specifier. For instance, in the approach by Barbiers (2005), which is based on Agree + VP-movement, VP2 has to move to derive (48):

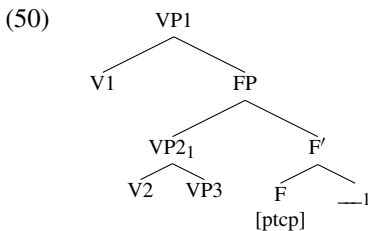

To obtain the correct interpretation, one either has to assume that F applies to its specifier rather than simply its c-command domain as is standardly assumed or that VP has to undergo obligatory reconstruction; this complication does not arise under the post-syntactic approach.

Even more serious issues arise with the remnant movement approach by Hinterhölzl (2009, 2018). Simplifying somewhat, massive (remnant) XP-movement takes place in the derivation of verb clusters for temporal licensing and subcategorization checking and targets aspect phrases. The displaced morphology is a phrasal affix in Asp2b of the extended projection of V2. The basic idea is that displacement obtains if an XP

(containing a verb) moves into the specifier of a phrasal affix that is associated with a higher VP.

The derivation of an example like (48) then proceeds as follows: VP3 moves to SpecAsp2bP, and VP2 moves to SpecAsp2aP. Finally, the entire Asp2aP is moved into SpecAsp1bP. At Morphological Form, the affix in Asp2b is affixed onto the verb in its specifier, viz. V3 (cf. Hinterhölzl 2009, 208–211; I have modified the labels to make the structure more transparent):

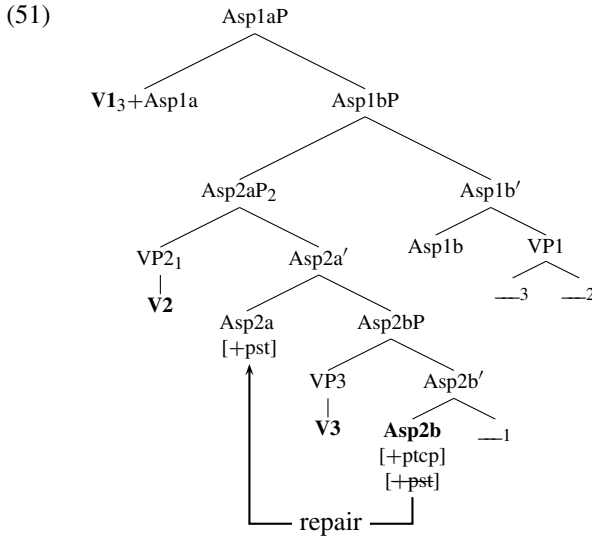

The problem with this derivation is quite obvious: In (51) the participle would apply to V(P)3 (Hinterhölzl assumes that the heads always semantically apply to their specifiers), deriving the wrong interpretation. To avoid that, Hinterhölzl proposes a repair operation which copies the *semantic* feature [+pst] from Asp2b to Asp2a (which then applies to the VP2 in its specifier). Note that this is a semantic repair in syntax; there is nothing wrong with the syntax as such, which casts doubts on the viability of this repair operation. A slightly different repair can be found in Hinterhölzl (2018, Sect. 5.1): Here, the semantic feature is copied onto a head above VP2, which then enters Agree with V2. This strikes me as equally problematic as the previous repair solution.¹⁴

It should have become clear that approaches to verb clusters that rely on syntactic operations to derive displacement run into serious difficulties once the semantic interpretation of the displaced morphology is taken into account. The post-syntactic approach is at a clear advantage here.

¹⁴ At first sight, one might argue that under remnant movement, the remnant VP has to be reconstructed anyway so that no problems arise for interpretation. However, if Barss' generalization (Barss 1986) is taken seriously, this would imply that while the remnant XP can be reconstructed, the XP extracted from the remnant cannot. Thus, in the PPI-example, if VP3 moves out of VP2 and VP2 undergoes remnant movement, VP3 cannot reconstruct into VP2 anymore, but this is crucially necessary to obtain the correct interpretation.

5 Restrictions on displacement

Importantly, displacement is not unrestricted. This has to do with the fact that once there is more than one selector of non-finite morphology in the same local domain, more than one exponent will have to be attached to the same verb if the ordering of VPs leads to displacement. Generally, displacement is possible as long as there are no conflicts between the selectional properties of the vocabulary items. I will discuss four different scenarios in this section: First, a conflict of the selectional properties leads to a crash of the derivation at PF; displacement is thus blocked. Second, displacement is possible despite a clash in selectional requirements because the features for one of the exponents are deleted by impoverishment. Third, displacement is possible because identical exponents can be deleted under identity. Fourth, displacement is possible because the vocabulary items are compatible with each other. Since the restrictions on displacement thus follow from independently established properties of vocabulary items, they provide yet another argument for a post-syntactic treatment. In the last subsection, I discuss *zu*-placement with prefix and particle verbs and in coordination.

5.1 Selectiveness

Initially, the free positioning of *zu* is reminiscent of that of special clitics (clitics subject to special ordering principles): It occurs at the edge of the verb cluster, viz., in second to last position when selected by an element outside the cluster. Therefore, the implications of *zu*-displacement for morphological theory may not be obvious (note that *zu* goes back to a preposition and thus a free-standing element, cf. Demske-Neumann 1994, 120–127 for diachronic data). However, the free positioning cannot be considered a diagnostic for clitic-status given that bona fide affixes like participles, *ge*-infinitives and gerunds are subject to the same (dis-)placement rules. Additionally, *zu* patterns with affixes in having selectional properties: it only attaches to verbs in the bare infinitive. Unlike the cognate English *to*, it cannot be separated from the verb by non-verbal material (*zu* also occurs inside particle verbs, cf. Sect. 5.5):

- (52) a. to quickly eat the bread
 b. um das Brot {schnell} zu {*schnell} essen
to the bread quickly to quickly eat.INF

The selectiveness of *zu* will be the crucial property for the analysis to follow. Other properties of *zu* that are usually taken to be relevant for the clitic-affix distinction are inconclusive in my view (see also Schallert 2019b for discussion): It differs from the past participle in that it neither shows any lexical exceptions (i.e., paradigmatic gaps) nor morphological idiosyncrasies, but the uncontroversially affixal bare infinitive is also completely morphologically regular and free of lexical gaps. The non-deletability in coordination discussed in Sect. 5.5 is also not restricted to affixes but occurs with clitics as well.

Because it shows selectiveness and flexible positioning, *zu* has been referred to as a phrasal affix, see Vogel (2009) and Hinterhölzl (2009). I will refrain from deciding on a strict classification of *zu* because the clitic-affix dichotomy has generally been

called into question from a cross-linguistic/typological point of view (Embick and Noyer 2001; Bickel et al. 2007) since the properties thought to distinguish clitics and affixes do not always line up. For this reason the distinction has been abandoned within Distributed Morphology (both morphological objects are inserted into terminal nodes). The fact that all non-finite categories behave the same with respect to displacement supports this view.

That selectiveness is a crucial factor in understanding the restrictions on displacement can be shown for *zu* as follows: In some Western Swiss German dialects (e.g., Bernese or Fribourg German), two-verb clusters with V1 = perfective auxiliary and V2 = participle allow both the 12 and the 21 order when V1 is finite, (53a). However, if V1 is non-finite, e.g. when selected by the complementizer *ohni* ‘without’, only the descending order is possible, (53d). The ascending order is ungrammatical, irrespective of whether *zu* is placed on V1 (i.e., not displaced), (53b), or whether it undergoes displacement to V2, (53c) (I am grateful to Raffaella Baechler for confirmation of the facts):

- (53) a. *das er s Buech hä₁ kchaufft₂/ kchaufft₂ hä₁*
that he the book have.3SG buy.PTCP buy.PTCP have.3SG
 ‘that he bought the book’ 12/21; *Swiss G., Western dialects*
- b. **ohni s Buech z ha₁ kchaufft₂*
without the book to have.INF buy.PTCP
 ‘without having bought the book’ 12; *Swiss G., Western dialects*
- c. **ohni s Buech ha₁ z kchaufft₂*
without the book have.INF to buy.PTCP
 ‘without having bought the book’ 12; *Swiss G., Western dialects*
- d. *ohni s Buech kchaufft₂ z ha₁*
without the book buy.PTCP to have.INF
 ‘without having bought the book’ 21; *Swiss G., Western dialects*

The reason why displacement is blocked here is the following: In the syntax, there will be a functional projection above the verb cluster for *z*, selected by *ohni* ‘without’. Importantly, *zu* itself selects an infinitive and thus an FP hosting the relevant feature, a fact I omitted in the diagrams and derivations in Sect. 3 above (more explicit derivations below will show that this does not affect the results). In addition, there will be another functional projection hosting the features for the participle selected by V1 between V1 and VP2:

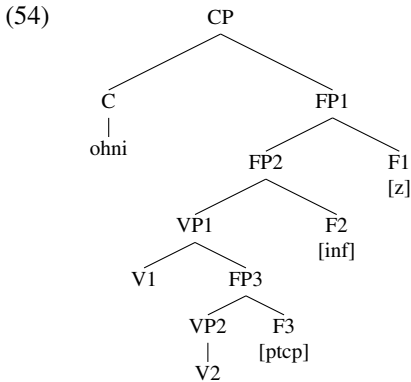

At linearization, the exponents for [ptcp] and [inf] are attached cyclically, viz., bottom-up/inside-out (Embick and Noyer 2001). Consequently, the participle exponent is attached to V2 first. Since the participle selects a stem, this will be felicitous. Thereafter, however, the infinitive exponent has to be affixed.

Affixation fails in this case because the infinitive suffix has to attach to the stem as well; but since the participial suffix has already been attached, this is no longer possible. In other words, the derivation crashes at the linearization of FP2 because the selectional properties of the inf-suffix are not respected. The failed displacement is schematically represented in (55):

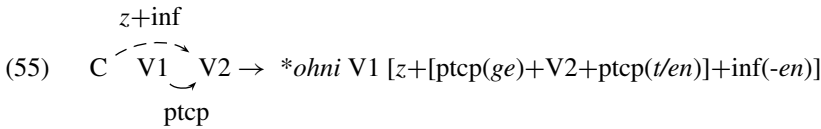

I have treated the participle morphology as a circumfix for ease of illustration, but nothing really hinges on this as long as the participial suffix is attached before F2 is considered. The same result obtains if the prefix is treated as a separate element, e.g., introduced by a readjustment rule or as a secondary exponent. Of course, participle formation may additionally involve ablaut; I will abstract away from this in what follows as it has no effect on displacement.

Importantly, displacement remains blocked even if V2 is a participle that does not take a *ge*-prefix (*ge*- fails to surface with stems that do not have initial main stress, a general property of prefix verbs) and happens to be identical to the infinitive (it belongs to the strong inflection and features no vowel change):

- (56) *ohni s ha z ver-gäss-e
without it have.INF to PREF-forget-PTCP
 ‘without having forgotten it’ *Swiss German (Western dialects)*

The derivation of (56) fails because the infinitive suffix cannot attach to the participle. It also shows that *zu* clearly has morphological selection requirements, i.e., it needs to attach to a verb in the bare infinitive; the fact that the past participle *vergässe* is phonologically identical to the bare infinitive is not sufficient (there is thus no phonological haplogy, see also footnote 21).

The problems I have just discussed in principle always obtain under multiple displacement because more than one exponent needs to be attached to the same verb. Since the selectional properties of the vocabulary items often conflict with each other, this will frequently lead to a clash in the morphology and thus to a crash of the (PF-) derivation. Accordingly, displacement is by necessity rather restricted.¹⁵

5.2 Conflict resolution by impoverishment

In the previous subsection, there was a conflict between the infinitive and the participle morphology. This conflict also obtains systematically in Aux-Mod-Inf clusters in the 123 order: Both the bare infinitive selected by V2 as well as the participle selected by V1 target V3 (for additional functional projections in infinitives like *wollp*, cf. Wurmbrand 2014):

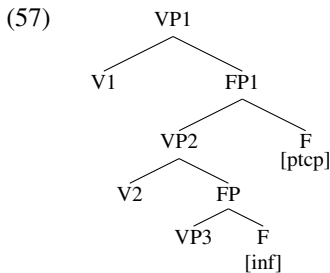

In this configuration, we predominantly find two solutions: the PPI-construction as in (48) or the IPP-construction, where both V2 and V3 appear as bare infinitives. In East-Central-German and East Franconian dialects, we instead often find a so-called supine form on V2 as in (58) (from Höhle 2006, 58)¹⁶:

- (58) *de hâsd₁ darfd₂ dringke₃*
you have.2SG may.SUP drink.INF
 ‘You were allowed to drink.’

Oberschwöditz

¹⁵ The derivation also crashes if there is no adjacent verb for the affix to attach to, e.g., when a PP is extraposed/right-adjoined to VP and thus linearized between V and F:

- (i) [FP [VP [VP V] PP] F] → V PF F
 ↑ x ↓

Extrapolation thus has to target FP, which is unproblematic under the assumption that the choice of extrapolation site is free.

¹⁶ Supines are non-finite verb forms that are characterized by a weak participial suffix affixed to the bare stem and the lack of the *ge-*prefix. They cannot be analyzed as past participles without prefixes because the suffix is always weak even if the verbs form the past participle according to the strong inflection; furthermore, the stem-vowel usually differs from the vowel of the past participle and that of the infinitive. The varieties differ with respect to the verbs that show supine forms. This usually includes modal verbs, while other infinitive-selecting verbs (like ‘see’, ‘learn’) can occur in the IPP-form (i.e., the infinitive); but in some varieties (e.g., in Oberschwöditz), even these appear as supines in complex clusters, cf. Höhle (2006, 57–63). Supines are attested in earlier stages of the language (cf. Jäger 2018) and also occur outside of the East-Central-German and the East Franconian area, e.g., in Low German (cf. Bölsing 2011), in Bavarian and in the Alsace (cf. Höhle 2006, 60f. for references). For examples in (the history of) Dutch, cf. Zwart (2007, 85f.).

I propose that the PPI- and the IPP-construction are two sides of the same coin: They result from deleting the features of one of the functional morphemes to be attached to V3 by means of impoverishment. Deletion of the participle features leads to the IPP-construction, deletion of the infinitive features results in the PPI-construction. Furthermore, since in both constructions, V2 fails to be associated with functional morphemes, default morphology is inserted, either an infinitive or a supine (depending on the variety).¹⁷

(59) IPP-construction

- a. linearization: V1 V2 V3 inf ptcp
- b. affixation: V1 V2 V3+inf ptcp
- c. impoverishment: V1 V2 V3+inf ~~ptcp~~
- d. default: V1 V2+inf/sup V3+inf

(60) PPI-construction

- a. linearization: V1 V2 V3 inf ptcp
- b. impoverishment: V1 V2 V3 ~~inf~~ ptcp
- c. affixation: V1 V2 V3+ptcp
- d. default: V1 V2+inf V3+ptcp

The derivations are schematically illustrated in (61) and (62):

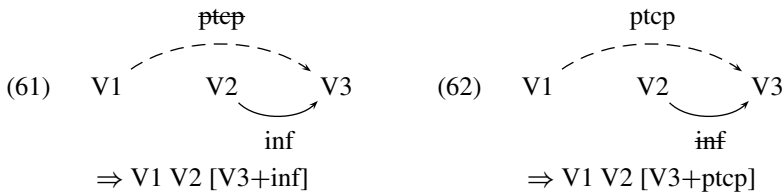

The infinitive has a double function: It can be regularly selected or it can act as a default if a verb does not receive any functional morphemes. The fact that only V2 appears as a supine, while V3 appears in the form selected by V2 in (58) provides clear support for that. Further evidence that the selectional requirements of V2 can be realized on V3 if those of V1 are deleted by impoverishment can be found in Steube (1995, 432), where in an Aux-Mod-Inf cluster V2 appears as a supine and V3 as a *ge*-infinitive as selected by V2 ‘can’ (cf. also footnote 30). The supine, however, only occurs as a default form; it therefore only occurs in 123 but not 132 orders (Höhle 2006, 62, ex. 20. vs. 21; 72, ex. 54ii vs. 55). The following minimal pair provided by Anita Steube (p.c.) illustrates the same point (V1 selects a bare infinitive, V2 a *ge*-infinitive):

- (63) doas=e will₁ mit än fliecher könd₂ ge-foar₃/ge-foar₃ kön₂
that=he wants with a plane can.SUP GE-go.INF/GE-go.INF can.INF
 ‘that he wants to be able to travel by plane.’ *Steinbach-Hallenberg*

Crucially, the supine arises not only with V1 = perfect auxiliary, cf. (58), but also with V1 selecting a gerund, cf. (76), (79); a bare infinitive, cf. (63); or a *ge*-infinitive, cf.

¹⁷ Hinterhölzl (2018) argues that displacement in the PPI-configuration is unproblematic because the participle featurally subsumes the infinitive. Since there is no transparent morphological relationship between infinitives and participles, this strikes me as unconvincing.

(75), showing that it is not selected by V1 (agreement in mood with the governing verb in some varieties suggests some interaction after all, cf. Höhle 2006, 58–59; for a cluster with two supines, cf. Jäger 2018, fn. 20).

Treating the absence of participial morphology in Aux-Mod-Inf clusters by means of impoverishment goes back to Wurmbrand (2004a). The main argument for this view comes from the fact that the IPP-construction has the same meaning as the version with the participle. Since syntactically the participial features are located in a functional head above VP2, the perfect semantics will apply to VP2. Impoverishment of the participle features at PF will not affect the interpretation (as in Sect. 4 above, this argument presupposes that the participle contributes to the meaning of the present perfect). Importantly, deletion of the participial features can be considered a means of conflict resolution only in the orders 123 and 231 (and perhaps 213), where both the infinitive and the participle would have to be affixed onto V3. In these orders, the impoverishment rule deletes the [ptcp]-features in the context of an infinitive. However, within German varieties, the IPP-effect is also found in the 132, the 312 and, more rarely, in the 321 order (cf. Zwart 2007; Wurmbrand 2017, Sect. 2.2; for an interesting exception, see Meurers 2000, 223). This suggests that in these varieties, the impoverishment rule deleting the features of the participle is more general in that it applies when a participle head has as its complement a V that selects an infinitival VP. Thus, conflict-resolution-induced impoverishment may historically be the first step, but in modern varieties that have the IPP-effect in several orders (and not just in the 123 order), synchronically there will arguably be just one general impoverishment rule.

Wurmbrand proposes that linearization follows impoverishment (she assumes that the infinitival form of V2 triggers the 132 order). For a variety that displays the IPP-effect only in the 123 order, the reverse order is needed to treat the deletion of participial features as a means of conflict resolution since the conflict only arises after linearization. However, once deletion of participial features has become a general rule of the language as is the case in many modern German varieties, nothing precludes ordering impoverishment before linearization. In fact, the impoverishment rule is easier to state when hierarchical structure is still present than under linear order, where the context restriction of the impoverishment rule would have to refer to the order in the cluster more generally and not just to adjacent verbs; in the subsequent derivations, I will thus order impoverishment before linearization.

The IPP-effect in a Standard German Aux-Mod-Inf cluster is thus derived as follows: There will be a functional head hosting the participial features above VP2. After impoverishment, cf. (64a), a mixed linearization (132) results, cf. (64b). Then, the inf-suffix after V3 will be attached, (64c). Finally, V2 receives infinitival morphology by default, (64d)¹⁸:

¹⁸ The fact that the IPP-effect also occurs in 132 clusters shows that synchronically it is unrelated to displacement (another argument is that Dutch, which does not have displacement, also displays the IPP-effect). Things are different from a historical perspective given that the earliest clusters have strictly ascending 123 order. If there is displacement in such an order, V2 will not receive any functional morphemes so that a default form on V2 arises; at a later point this may be reinterpreted as a general rule so that impoverishment applies to participial features even in orders where no feature conflict arises, a plausible diachronic scenario in my view. For a recent historical overview of the IPP-effect, see Jäger (2018).

- (64) a. impoverishment: [VP1 [FP1 [VP2 [FP2 [VP V3] F2] V2] F1_[ptcp]] V1]
 → [VP1 [FP1 [VP2 [FP2 [VP V3] F2] V2] F1_[ptcp]] V1]
 b. linearization: V1 V3 inf V2
 c. affixation: V1 V3+inf V2
 d. default: V1 V3+inf V2+inf

Impoverishment also makes *zu*-displacement in 132 clusters as in (9b) possible: The syntactic structure would be as in (65) with several FPs:

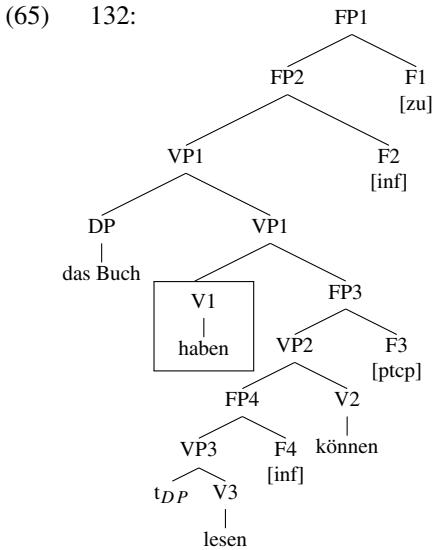

After impoverishment of the participial features of F3, (66a), a mixed linearization obtains where F4 is linearized after VP3 and F2 and F1 after VP2, cf. (66b). Given cyclicity, the *inf*-suffix after V3 will be attached first, (66c). Since no participial affix is inserted in this order, no conflict arises with the infinitive suffix inserted into F2 so that it can be affixed, followed by Local Dislocation of *zu*, which attaches to the left of the newly built V2+Inf-complex, cf. (66d). Because of displacement, V1 is not associated with any functional morphemes and thus receives infinitival morphology by default, cf. (66e):

Footnote 18 continued

An even more general impoverishment rule seems to be at work in some Thuringian dialects where displacement from V1 (selecting a *ge*-infinitive, a *zu*-infinitive or a gerund) to V3 fails even though V2 selects a bare infinitive, so that both V2 and V3 appear in the bare infinitive, cf. Höhle (2006, 68, fn. 23; 69, ex.42/43; 71, ex. 49–53; 72, ex. 55). Apparently, the impoverishment rule in these varieties systematically deletes the selectional properties of V1 even if there is no conflict with those of V2.

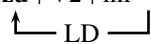
- (66) a. impoverishment: [[[[[V3 F4_[inf]] V2] F3_[ptcp]] V1] F2_[inf]] F1_[zu]
 → [[[[[V3 F4_[inf]] V2] F3_[ptep]] V1] F2_[inf]] F1_[zu]
 b. linearization: V1 V3 inf V2 inf zu
 c. affixation: V1 V3+inf V2 inf zu
 d. zu-placement: V1 V3+inf V2 inf zu → V1 V3+inf **zu**+V2+inf
 e. default: V1+**inf** V3+inf zu+V2+inf 

Impoverishment in 132 orders can thus also have a conflict-resolving function as a side effect in that it removes the features for an exponent that might conflict with other exponents that are to be attached to the same verb.

If no impoverishment takes place, a strictly descending 321 order obtains; the F-head hosting [ptcp] would be linearized after VP2, while the F-heads hosting the features for *zu* and the infinitive would be ordered after V1, (67a). There is no feature conflict so the participle attaches to V2 and *zu*+inf attach to V1, while V3 receives infinitival morphology from V2, as in (9a) above:

- (67) a. linearization: V3 inf V2 ptcp V1 inf zu
 b. affixation: V3+inf V2+ptcp **zu**+V1+inf

Given the possibility of impoverishment, one may wonder why impoverishment was not an option to resolve the feature conflict in the previous subsection, where in ex. (53c) *z*+inf had to attach to a participle in 12 order. Deleting the features of the participle can be ruled out given that the IPP-effect is restricted to larger verb clusters. Thus, synchronically, there seems to be no general conflict-resolving impoverishment rule (anymore?) in this variety. Consequently, deleting the participle features in two-verb clusters is not an option. Deleting the infinitive instead would violate *z*'s selectional properties. Deleting *z*, finally, would arguably violate recoverability.¹⁹

¹⁹ Impoverishment also has a conflict-resolving function in the ascending attributive participle clusters mentioned in footnote 4: deletion of the past participle features of the F-head following V2 makes attachment of the present participle possible, essentially as in the derivation in (66). Interestingly, ascending participle clusters where V1 selects a *zu*-infinitive are ungrammatical (cf. **der das Buch versuchen₁ zu les-ende₂ Schüler* 'the student trying to read the book'). Here, *zu*+inf are attached to V2 first. The present participle, which needs to attach to the stem, then cannot be affixed anymore to V2, leading to a crash of the derivation at PF. Interestingly, the surface-identical modal passive is grammatical as an attributive participle (*das zu les-ende Buch* 'the book that is to be read'). This suggests, in line with claims in the literature, that *zu* is not an infinitival marker in this construction but a modal element (that does not select an infinitive so that the participle can be attached).

Displacement and the unavailability of impoverishment may also account for the rarity of three-verb clusters in German varieties where V3 is a participle and occurs in cluster-final position (cluster-final participles in 2-verb Aux-Ptcp clusters are well-attested, though). In Mod/Fut-Aux-Ptcp-clusters only the orders 132, 312 and 321 are well-attested (for rare examples with 123 in Bernese, cf. Hodler 1969, 684, 3). In the 123 order, both the participle morphology selected by V2 and the infinitive selected by V1 would be displaced to V3. Attachment of the infinitive will be blocked for the same reason that *zu*+inf cannot attach to Bernese Aux-Ptcp-clusters in 12 order. With impoverishment of participle features restricted to Aux-Mod-Inf clusters, the conflict cannot be resolved and the derivation crashes at PF.

5.3 Haplology/deletion under identity

In this subsection I discuss two configurations where a conflict is avoided because exponents can be deleted under identity; in one case, both selectors select the same non-finite category, in the other, the selected categories are in an inclusion relationship.

5.3.1 V1 and V2 select the same form

In the so-called missing-*z* construction in Swiss German (cf. Bader 1995, 22, 26), there are two *z*-selectors in ascending order ('seem' and 'try' in (68)), but we find only one *z*, on V3, the last verbal element of the cluster (while V2 appears in the bare infinitive)²⁰:

- (68) wüu dr Hans sine Fründe schiint₁ probiere₂ **z** häuffe₃
because the John his.DAT friends seem.3SG try.INF to help.INF
 'because John seems to try to help his friends' *Bernese German*

In (69), the FP-complements of *zu*-selecting verbs are linearized in either strictly left-branching or strictly right-branching order (the latter option is the predominant one in Swiss German; mixed linearizations like 132 and 312 are possible as well, depending on the variety):

²⁰ Missing *z* seems to be optional, which can be accounted for if FP3 can undergo extraposition in which case it patterns like the 3rd Construction in Standard German, see Salzmann (2019). According to Cooper (1995, 188f.), missing *z* is limited to Verb Raising cases (i.e., uninterrupted clusters) and is blocked in Verb Projection Raising. However, this claim could not be verified in an informal survey. Furthermore, a google search delivers two counter-examples, see (ia) and (ib):

- (i) a. ... ohni öpe jeh mau säuber probiere₁, Dütsch z rede₂
without PRT ever once self try.INF German to speak.INF
 'without ever trying to speak German oneself' *Swiss German*
<http://www.chefkoch.de/forum/2,22,296109/An-alle-CHer-Wir-zelebrieren-den-Kantonleigeist.html>,
 accessed March 28, 2013.
- b. S Ziel isch nid blibe z' stah sondern versueche₁ glich z bliebe₂
the goal is not stay.INF to stand.INF but try.INF same to stay.INF
 'The goal is not to make no progress but to try to remain the same.' *Swiss German*
<http://www.mosiweb.ch/maennerriege/maennerriege.htm>

Another counter-example can be found in the description of the dialect of Bosco Gurin, see Comrie and Frauenfelder (1992, 1058) (the complementizer *fer* selects a *z* as does *tüa/tian*; the infinitive of causative 'do' always appears as a gerund):

- (ii) Ech ha ts Büach kchöiff, fer ts Chenn tian₁ waldsch z leeran₂.
I have.1SG the book bought for the child make.GER Italian to learn.GER
 'I bought the book in order to make the child learn Italian.' *Bosco Gurin*

Missing-*z* also seems to be (marginally) available for some speakers of (spoken) Standard German, see footnote 22 below and Salzmann (2019) for discussion.

(69) left-branching:

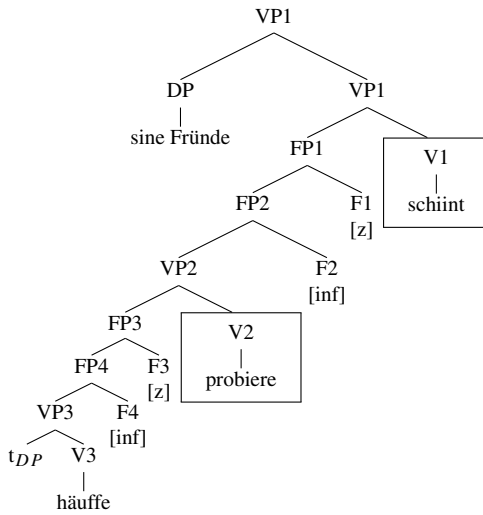

(70) right-branching:

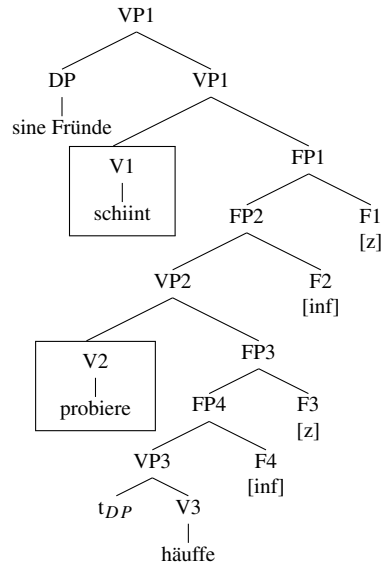

After linearization of (69), there will be a *z* and an infinitive suffix adjacent to each verb, thus deriving the unspectacular ‘well-behaved’ Standard German case in (7d) above. After linearization of (70), however, both *zs* and both infinitive suffixes follow the verb cluster, cf. (71a). I propose that the two *zs* and the two infinitive suffixes are reduced to one by haplology. More precisely, given cyclicity, the infinitive and the *z* adjacent to V3 are considered first; the infinitive is suffixed to V3, cf. (71b), and *z* undergoes Local Dislocation and thus prefixes to the V+inf complex, cf. (71c). Then, the second inf and *z* are considered. The infinitive is suffixed to V3, while *z* undergoes Local Dislocation, whereby it is prefixed to the entire complex, cf. (71d). Then, the outer *z* and the outer inf-morpheme are deleted under identity with the adjacent morphemes, cf. (71e). Deletion is unproblematic here without crashing the derivation because it is recoverable. Since V2 does not receive any functional morphemes, it receives infinitive morphology by default, (71f)²¹:

²¹ Note that this is an instance of morphological haplology. Deletion is only possible because the terminal hosting the second *z* bears the same features. Phonological haplology would wrongly predict haplology with verbs taking the *zu*-prefix like *zugeben* ‘admit’, which appears as *zuzugeben* ‘to admit’. Consequently, the morpho-syntactic features must not be deleted after Vocabulary Insertion, cf. Embick (2015, 91, 107ff.) (recall also ex. (56) above).

Haplology could, in principle, also be handled by means of impoverishment before vocabulary insertion (but after linearization). However, the data in Sect. 5.4 strongly suggest that the selectional requirements are checked under linear adjacency. In the case of *zu*-haplology, *zu* will therefore only see the adjacent infinitival suffix after linearization in (71) so that affixation and Local Dislocation will not be blocked. Therefore, haplology must follow Local Dislocation. The same holds for haplology involving *ge*-infinitives, cf. ex. (75). In the case of infinitive and gerund haplology (see Sect. 5.3.2), however, impoverishment could be ordered before insertion since the functional head would be adjacent to the suffix bearing the same features.

- (71) a. linearization: V1 V2 V3 inf z inf z
- b. inf-affixation: V1 V2 V3+**inf** z inf z
- c. Local Dislocation: V1 V2 **z+V3+inf** inf z
 ↑ ↓
 LD
- d. inf-affixation + LD: V1 V2 **z+z+V3+inf+inf**
 ↑ ↓
 LD
- e. deletion under identity: V1 V2 z+z+V3+inf+inf
- f. default: V1 V2+**inf** z+V3+inf

The haplology effect can be schematically illustrated as follows:

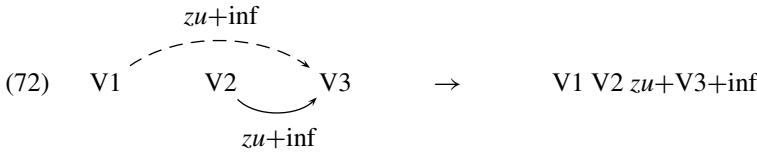

Haplology with *zu* may be more widespread than previously thought: In Frisian, where the cluster order is normally strictly descending, *te* (‘to’)-infinitives allow the 312 order. In (73), a slightly modified version of the original example in Den Dikken and Hoekstra (1997, 1062) that was provided by Eric Hoekstra (p.c.), both the complementizer *om* and V1 *hoeve* ‘need’ select *te*+gerund. Interestingly, we only find one *te*, crucially before the cluster-final verb V2:

- (73) ... *om* net kontrolearre₃ *hoeve*₁ te wurden₂
to not check.PTCP need.INF to become.GER
 ‘in order to not have to be checked’ 312 Frisian

This pattern obtains if there is displacement and haplology, which can be derived by means of VP3-movement (contained in FP5), (74a), and ordering of FP3 after V1, (74b) (F1/F3 contain the features for *te*, F2/F4 the features for the gerund, F5 the features for the participle):

- (74) a. [FP1 [FP2 [VP1 [FP3 [FP4 [VP2 [FP5 [VP3 V3] F5] V2] F4] F3] V1] F2] F1] →
 [FP1 [FP5 V3 F5]]₁ [F1]' [FP2 [VP1 [FP3 [FP4 [VP2 ___ V2] F4] F3] V1] F2] F1]]
 b. ordering:
 [FP1 [FP5 V3 F5]]₁ [F1]' [FP2 [VP1 **V1** [FP3 [FP4 [VP2 ___ V2] F4] F3]] F2] F1]]

After linearization and attachment of the two *te*-prefixes and the two gerund-suffixes, the outer ones are deleted under identity, as in the Swiss German example above. The fact that V1 appears as a bare infinitive and not as a gerund (like V2), which is the form normally selected by *te*, suggests that there has been no *te*-deletion on V1 (Eric Hoekstra p.c.); rather, V1 has not been associated with any functional morphemes and therefore appears in the bare infinitive by default.²²

In (75), haplology occurs with *ge*-infinitives: V1 and V2 select a *ge*-infinitive, which occurs on V3, while V2 appears as a supine (Höhle 2006, 70):

²² In Standard German 3-element cluster-like constructions with V1 selecting a *zu*-infinitive (recall footnote 7), haplology effects seem to be possible to some extent, but the facts are subtle and require empirical verification (judgments vary), especially in the 312 order:

to (77) in that the inf-suffix selected by the higher selector is deleted under identity. In (19a) and (21), the lower selector selects a bare infinitive and the higher a *ge*-infinitive. In (19b), the lower selector selects a bare infinitive and the higher one a gerund. Since the infinitive is usually identical to the verb stem in Thuringian varieties, displacement will generally be unproblematic if one of the selectors governs the bare infinitive as it amounts to zero (haplology is thus unnecessary). Displacement under an inclusion relationship is schematically illustrated in (78):

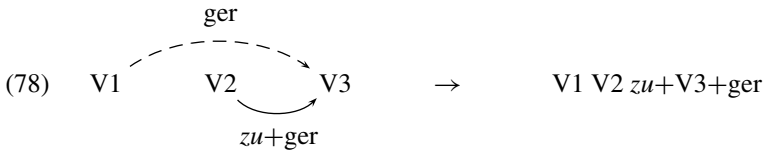

5.4 Cumulativity: both exponents are attached

One of the strongest arguments for a post-syntactic perspective comes from examples like (79): Here, V1 selects a gerund, usually realized by the suffix *-e* in East Central and East Franconian varieties, while V2 selects a *ge*-infinitive, which amounts to a bare stem with a *ge*-prefix because the infinitive is identical to the stem in these varieties. Since these are marked forms that are not in a subset relationship, one expects a clash. However, the combination is felicitous: V3 bears both the *ge*-prefix and the gerund-suffix, see Steube (1995, 432f.)²³:

- (79) öb-sd=e wörschd könd ge-kom-e
if-2SG-you will.2SG can.SUP GE-come-GER
 ‘whether you will be able to come’
Steinbach-Hallenberg

Thus, a non-finite form arises on V3 that is never selected by a single verb and thus would never occur in a two-verb cluster, viz. *ge+V3+ger*. (79) crucially suggests that the selectional restrictions of the vocabulary items are checked under linear adjacency rather than hierarchically: the gerund, which must attach to the stem, may be blocked when trying to attach to a complex head consisting of verb stem and *ge*-infinitive. Under a linear perspective, however, after Local Dislocation of the *ge*-infinitive, the gerund suffix is adjacent to the verb stem and affixation is successful. Local Dislocation of the *ge*-prefix thus counterbleeds gerund-suffixation²⁴:

- (80) a. linearization: V1 V2 V3 ge ger
 b. Local Dislocation: V1 V2 **ge+V3** ger
 ↑ LD ↓
 c. gerund affixation: V1 V2 ge+V3+**ger**

²³ As pointed out in Höhle (2006, 68f., fn. 24), some speakers prefer a variant without the gerund, i.e., a form where the selectional requirements of V1 are suppressed, cf. footnote 30. According to Anita Steube (p.c.), the version with a gerund suffix is completely regular but mainly occurs in epistemic readings of ‘will’, while in purely futurate readings, the gerund suffix is missing.

²⁴ Should the infinitive involve a suffix after all in a variety, the gerund would have to be decomposed into gerund + infinitive. Attachment of the gerund would then involve haplology of its infinitival suffix.

Checking selectional restrictions under adjacency will also work for *zu*-placement as discussed above even though it is not adjacent to the infinitival suffix on the surface: Given head-final linearization, *zu* will be adjacent to the infinitival suffix at insertion; subsequent Local Dislocation does not affect this anymore. In Embick (2007, 321, 331f.) it is assumed that elements that undergo Local Dislocation are adjoined to their host. If selectional requirements were checked hierarchically, *zu* might only see the verb stem but not the infinitival suffix; similarly, affixation of the infinitival suffix to a participle could not so easily be prevented if the selectional requirements are checked hierarchically as the inf-suffix would only see the verb stem.

The derivation of cumulative non-finite morphology is illustrated in (81):

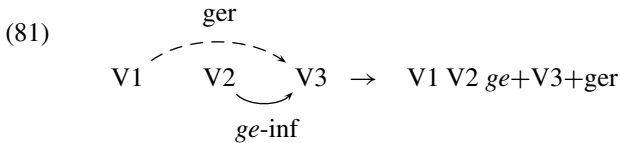

5.5 Interaction with prefix and particle verbs and coordination

The placement of non-finite morphology is sensitive to the distinction between prefix and particle verbs. While the non-finite morphology attaches to the left of the prefix in the case of prefix verbs (this only holds for *zu*, the *ge*-prefix is deleted in most German varieties for prosodic reasons), it occurs between particle and stem in the case of particle verbs:

- (82)
- a. ver-stellen → **zu** ver-stellen
PREF-put.INF to PREF-put.INF 'block'
 - b. auf-stellen → auf-**zu**-stellen
on-put.INF on-to-put.INF 'to set up'

I propose that the asymmetry follows from the fact that prefix verbs form an impenetrable unit, while particle words are not complex words. The impenetrability of prefix verbs follows from general principles of Local Dislocation (cf. Embick and Noyer 2001, 577): There is a structure preservation principle that holds for PF-operations in that so-called morphosyntactic words, viz., heads that are not part of complex heads, and so-called subwords, viz., segments of complex heads, have to target objects of the same type when moved at PF. Prefix verbs are complex heads, it is thus the entire prefix verb that counts as a morphosyntactic word. Consequently, the non-finite exponent inserted into F, which also constitutes a morphosyntactic word, attaches to the entire prefix verb rather than infixing between prefix and stem (the same result obtains, of course, if prefix verbs are only morphologically but not syntactically complex); note that the same structure preservation principle is at work in several derivations in the previous sections where *zu* inverts with the V+inf-complex.

Assuming that particle verbs are not complex heads is generally preferable: First, under a complex head analysis there has to be obligatory excorporation under verb second movement (the particle is always stranded), which is spurious. Second, particles can also be moved to the prefield, a position only occupied by phrases; third, particles can be separated from the verb in V-final sentences when modified by PPs, cf. Müller

(2003, 290f.). See also Abels (2016) who treats particles as VPs that depend on the lexical verb. This accounts for the fact that particles (like bare VPs) cannot be scrambled and that the governing verb cannot be topicalized without the particle (they thus behave like bare VPs that cannot be stranded under topicalization of the governing VP).²⁵

An interesting complication arises with coordination. Since *zu/z* realizes a separate head, one might expect it to be able to have scope over a coordination. However, this is not the case: Both verbs have to bear *zu/z* (unlike English *to*), cf. also Cooper (1995, 191) and Haider (2011, 237):

- (83) Er hät versproche, *(z) schriibe und regelmässig *(z) telefoniere.
he has promise.PTCP to write.INF and regularly to phone.INF
 ‘He promised to write and to phone regularly.’ *Swiss German*

This may initially seem problematic. However, the restriction observed in (83) is part of a more general pattern: Obligatory repetition in coordination is a frequent feature of phonologically/morphologically dependent elements. Thus, typologically, occupying an independent syntactic head does not imply scope over the coordination, see e.g., Romance function words (including the infinitive markers *de, à* ‘to’), cf. Miller (1992) and Abeillé et al. (2006, ex. 12–14, 22), prepositional dative marking in Swiss German, cf. Seiler (2002, 252), or the definite article in Amharic (Kramer 2010). Embick (2007, 332f.) argues that post-syntactic operations like Lowering or Local Dislocation have to apply across the board (ATB). This can be seen in the impossibility of VP-coordination under T[past/pres] in English and asymmetric fusion between preposition and article in French (both phenomena involve Lowering, from T to V/P to D):

- (84) *John T slice-d and cook/*slice-s and cook

- (85) J’ai parlé ...
 a. au père et *(à) la mère.
to.the father and to the mother
 b. *au père et le garçon
to.the father and the boy
 c. au père et au garçon
to.the father and to.the boy

French

Why PF-operations display this restriction in their interaction with coordination (and why they sometimes do not, cf. Harizanov and Gribanova 2014, ex. 30 on the definite

²⁵ The only difficulty for this view is presented by those prefix verbs (they all happen to be backformations) that are immobile in syntax, i.e., that cannot undergo verb second, but can take affixes like *zu*, cf. *uraufführen* ‘premiere’ → *uraufzuführen* ‘to premiere’. I am thus led to assume that they do not form complex elements in syntax and that their immobility cannot be reduced to conflicting morphological requirements of prefix and particle but is due to different factors, cf. Müller (2010); this seems to be unavoidable anyway given that other backformations like *sonnenbaden* ‘sunbathe’ also fail to undergo verb second and have an ‘infixing’ *zu* but are not characterized by conflicting morphological requirements. For more discussion of immobile verbs, see, e.g., Stiebels and Wunderlich (1994, 944–947). In Middle High German, *zu* could also occur before the particle, cf. Demske-Neumann (1994, 123f.).

article in Bulgarian) is a question I have to leave for future research. See also Kramer (2010, 215–218) for discussion of this issue.²⁶

6 Implications for morphological theory

The previous sections have provided several arguments in favor of a realizational and crucially post-syntactic approach to morphology as pursued within Distributed Morphology: First, the placement of non-finite morphology is not exclusively governed by hierarchical notions but is crucially affected by linearity and adjacency. Second, displacement of non-finite morphology does not have any semantic effects. Third, restrictions on displacement can be related to selectional properties of the vocabulary items. Perhaps the most spectacular empirical fact involves non-finite verbs that are specified for more than one non-finite category. In this section, I will discuss the implications for morphological theory by comparing the post-syntactic approach with both pre-syntactic approaches and representational/parallel realizational approaches. I will show that the facts discussed in this paper constitute serious problems for a pre-syntactic approach to morphology; alternative realizational approaches fare somewhat better but cannot account for the whole range of data and are confronted with conceptual drawbacks.

6.1 Arguments against pre-syntactic morphology

The first argument against pre-syntactic morphology comes from morphological selection quite generally. Since the non-finite morphology is expressed on the ‘wrong’ verb, one would expect violations of the verbs’ selectional properties during structure building; in such approaches, inflected words are formed before they enter the syntax. Thus, to derive the PPI-construction, for example, the participle morphology would have to be on V3 from the start, while V2 starts out as an infinitive. However, once V2 is combined with VP3, the derivation crashes because V2’s selectional require-

²⁶ There is an interesting wrinkle in that *zu* can be missing in X^o-coordination as in (i):

- (i) weil er das Geld [zu gewinnen und verschenken] versucht
because he the money to win.INF and give.away.INF try.3SG
 ‘because he tries to win and give away the money’ Sabel (2000, ex. 22a)

At first sight, the phenomenon seems to violate the ATB-requirement stated above. However, the pattern falls out nicely once it is recognized that it involves an X^o-coordination so that the entire coordination counts as a morphosyntactic word. Consequently, *zu* will attach to the left of the entire coordination. This may not yet be sufficient because a *zu* in the second conjunct is required if the governing verb undergoes V2-movement or if the infinitiveP is extraposed, cf. Sabel (2000). This may suggest that the phenomenon rather involves *zu*-deletion under adjacency with the governing verb. A further argument for a deletion account comes from the fact that other non-finite forms do not show the same flexibility; the past participle and the infinitive always have to be repeated, even under X^o-coordination. For a deletion account in Dutch, which shows a similar pattern, cf. Zwart (1993, 104f.).

In earlier stages of German, *zu* could be omitted in non-initial conjuncts more generally (not just under V+V-coordination), see Behaghel (1923–1932, Volume 2, 308) and Sabel (2000); there are even cases where only the *zu* of middle conjuncts is missing, cf. Behaghel (1923–1932, Volume 2, 308) and Ebert et al. (1993, 397, §179). For data from older stages of Dutch, see Hoeksema (1995).

ments are not met as it selects an infinitive rather than a participle. This problem arises not only for [+lexical, +incremental] approaches (cf. the terminology in Stump 2001), where the syntactic features are contributed by the morphemes (i.e., do not exist independently) but also for pre-syntactic realizational approaches like Bruening (2017). In his approach complex heads (e.g., inflected verbs) are constructed in separate workspaces and morpheme insertion takes place before the complex head merges with other syntactic objects. Since all the inflectional information is part of the verb from the beginning (in the PPI-case, the verb root would have to be merged with a functional head contributing the past participle information), mismatches as with displaced morphology are unexpected. As a consequence of the fact that the participle morphology would be located on the ‘wrong’ verb from the start in the PPI-construction (on V3), pre-syntactic approaches also crucially make the wrong prediction w.r.t. semantic interpretation: The participle should be interpreted on V3, contrary to fact (under Bruening’s approach, problems with semantic interpretation can perhaps be avoided if the participle is just the reflex of an Agree relationship with a higher silent participle head that is interpreted instead).

Perhaps the most spectacular problem for a pre-syntactic approach comes from the cumulative non-finite forms discussed in Sect. 5.4: Such forms would simply never be generated. In such models, verbs would be inflected for certain categories according to general rules, and as far as I can tell, there is no room for a verb to be inflected for two non-finite categories simultaneously.

Another serious issue for morphological selection under a pre-syntactic approach comes from default forms, i.e., the infinitives and supines in three-verb clusters with displacement from V1 to V3. In the case of IPP, one could argue that the infinitive on V2 is a perfect allomorph. The supines are much more difficult to accommodate because they can occur if V1 selects a past participle, cf. ex. (58); a bare infinitive; cf. (63); a *ge*-infinitive, cf. ex. (75); or a gerund, cf. ex. (76). The supines are thus obviously default forms independent of the selectional restrictions of V1. Under a pre-syntactic approach, there is absolutely no motivation for these forms, while the supines and the IPP-forms follow naturally under the post-syntactic perspective since they are a default that only kicks in if a verb fails to be associated with functional morphemes.

Equally problematic for a pre-syntactic approach is the order-dependency of morphological selection, i.e., the fact that we find faithful realization in some orders and displacement and default forms in others. One could perhaps add directionality statements to the selectional features (as in Bader and Schmid 2009) such that faithful forms are only selected to the left but not to the right. This may provide a handle on the default forms but is insufficient for displacement (V1 does select its regular form in these contexts). However, it even fails for the default forms once topicalization is taken into account: At least in the dialect of Steinbach-Hallenberg, V3 often appears as a default bare infinitive if it undergoes topicalization rather than bearing the (displaced) form selected by V1 or the form governed by V2; and instead of the supine on V2 we find the form selected by V1, cf. (86b) (Anita Steube, p.c.). The pattern is thus somewhat different from 132 orders where we find faithful realization not only on V2 but also on V3, recall (63). Consider the following minimal pair where the base-line

example in (86a) shows cumulative realization of non-finite morphology on V3 (recall Sect. 5.4) and a supine form on V2:

- (86) a. *doas e ned wörd₁ könd₂ ge-kom-e₃*
that he not will.3SG can.SUP GE-come-GER
- b. *Komm₃ wörd₁ e ned kön-e₂*
come.INF will.3SG he not can-GER
 ‘He will not be able to come.’ Steinbach-Hallenberg

Adding directionality statements to selectional features will be insufficient here; to obtain the correct form on V2 and V3, the selectional properties of V1 and V2 would have to be sensitive to whether V2’s complement undergoes topicalization. Under the post-syntactic approach, the default bare infinitive (which is reminiscent of the English Perfect Participle Paradox as in *We had to stand firm and stand firm we have*) would result if the functional morpheme above the topicalized V3 undergoes impoverishment (for whatever reason).²⁷

In summary, then, displaced morphology constitutes an extremely severe if not insurmountable problem for pre-syntactic approaches to morphology.²⁸

6.2 Representational alternatives

I now turn to what I will call representational approaches. In these approaches both the syntax as well as the placement of non-finite morphology are handled by constraints that apply to representations.

Meurers (2000, 189–194, 214f.) argues that verbs in the upper-field, i.e., verbs in (partially) ascending order, are not regular verbs but functional elements. Not being proper verbs, they cannot be governed nor can they act as governors. As a consequence, they cannot determine the status of verbs that depend on them, e.g., a perfective auxiliary as V1 cannot govern V2 in the 132 order. This not only accounts for the IPP-effect but also for *zu*-displacement in 132 orders: the complementizer *ohne* ‘without’ selects a complement specified for the *zu*-infinitive. Since V1 is not a verb, it is consequently not the head of the verbal projection that *ohne* combines with. Instead, the cluster-final V2 is the head of VP and thus correctly occurs as a *zu*-infinitive; verbs in ascending order are thus ignored in the government chain. The approach seems attractive in that it

²⁷ Note that (86b) may at first sight point towards a covert left-dislocation analysis with phonetic deletion of the dislocated D-pronoun (as proposed in Zwart 1993, 262f.). Indeed, the form of V2 and V3 remains unaltered if there is an overt left-dislocated pronoun following V3. However, one does not always find a default form on V3: The selected form appears if V2 (e.g., *brauchen* ‘need’) selects a *zu*-infinitive or a gerund (in the case of *bleiben* ‘stay’). Even more puzzlingly, in two-verb clusters, we find the selected *ge*-infinitive on topicalized V2 (with V1 = *können* ‘can’), but if V1 is *werden* ‘will’ we find the bare infinitive rather than the expected gerund on V2 (while with *bleiben* ‘stay’ we do find the gerund). In all cases, an overt pronoun does not affect the topicalized forms. While I have to leave detailed exploration of the topicalization patterns for further research, they strongly suggest that the left-dislocation + deletion reanalysis cannot be generally correct. See Salzmann (2013a, 102f.) for further evidence against Zwart’s reanalysis.

²⁸ *Zu*-displacement can be accommodated in such approaches if *zu* is treated as an independent syntactic element (a clitic), which is plausible in lexicalist models. However, the fact that bona fide inflectional morphology shows identical behavior with respect to displacement rather suggests that a separation of the exponents of non-finite categories into lexical and syntactic is on the wrong track.

unifies the IPP-effect and *zu*-displacement. However, the approach fails in one fundamental respect: It is simply not correct that verbs in the upper-field, viz., in ascending order, do not govern. Next to the potential counter-examples Meurers discusses himself on p. 221 (see also footnote 7), there is ample evidence for government by verbs in ascending order, recall the examples with displaced morphology selected by V1: the *z*-infinitive in (16a) and (16b), the participle in (18), the *ge*-infinitive in (19a) and the displaced gerund in (19b). Therefore, the treatment of verbs in ascending order as functional elements (in Meurer's sense) cannot be correct.

The proposals by Bader (1995) and Vogel (2009) are similar to the DM-approach in that they are also realizational (Bader's HPSG-approach is inferential-realizational in Stump's terminology, Vogel's is arguably lexical-realizational, but he is not explicit about it). They differ from the derivational/post-syntactic perspective pursued here in that there is no separate syntactic head bearing features for the non-finite morphology; instead, the features are borne by the entire infinitival complement but crucially not by the head of this verb phrase (in Bader's HPSG-approach it is a so-called EDGE-feature otherwise used for clitic placement). Crucially, the morphological realization of the feature is the result of special realizational rules (Bader) or an alignment constraint (Vogel). (87) captures the intuition of Vogel's analysis and is arguably equivalent to Bader's EDGE-feature realization rule²⁹:

(87) *zu* is realized on the right-most verb *within* the XP bearing [zu]

This works for both well-behaved *zu* in 321 orders as well as for displacement in orders that deviate from it: The feature is realized on the right-most terminal of the relevant phrase. It thus captures the intuition that the placement of *zu* depends on the surface order within the verbal complex and not the hierarchical relations. I will first discuss possible conceptual objections before addressing problems that arise for representational accounts when several non-finite forms interact; for discussion of further issues (related to the treatment of CP-complements and the 3rd Construction), see Salzmann (2013b, 102–106). Starting with conceptual objections, such special features that are only present on the maximal projection of a head but not on the head itself certainly avoid the postulation of several functional heads (as my derivational approach is forced to); however, they also come at a cost: First, they increase the number of feature types (for instance, one will need different features for finite morphology, see Sect. 7.2 below). Second, such features are incompatible with endocentric phrase structures, especially under current Minimalist assumptions such as Bare Phrase Structure (Chomsky 1995): It is simply not possible for a feature to be present only on the maximal projection but not on the head as they share all relevant features. Furthermore, the rule essentially incorporates the descriptive generalization; it would thus be just as plausible as the reverse rule and therefore misses a crucial property of displacement: It is related to the head-finality of the language, an intuition that is captured more directly in the approach proposed above.

²⁹ Vogel's original formulation on p. 329, which defines *zu*-placement w.r.t. the extended projection of the phrase bearing the *zu*-feature, derives the wrong result in a number of cases, see Haider (2011, 250) and Salzmann (2013b, 103ff.) for discussion.

Turning to the interactions, the only type discussed in those works are the haplogy cases with *zu* in Bader (1995). In this approach, the fact that there is just one *z* on V3 indeed follows automatically. However, serious problems arise for the HPSG-approach with the other interactions (inclusion relationships as well as cumulative realization), because they involve conflicting requirements on the realization of V3 that cannot be resolved (Olivier Bonami, p.c.). Furthermore, it remains unclear how conflict resolution as in the IPP- and the PPI-construction can be integrated. Under Vogel's approach, there will also often be conflicting features for the realization on V3. Perhaps, they can be handled by different relative rankings of faithfulness constraints, but since none of this is explicitly addressed, I will refrain from speculating.³⁰

7 Absence of displacement

In this section, I will discuss verb clusters where there is no displacement although the structural condition, viz., an (partially) ascending order, is given. This implies that an alternative mechanism to associate (non-)finite morphology with the verb is necessary. Crucially, this will not only be necessary to account for cross-linguistic variation in placement patterns within Continental West-Germanic but also for variation within individual varieties.

7.1 *te*-placement in Standard Dutch

As mentioned at the beginning, Standard Dutch systematically differs from German with respect to the placement of non-finite morphology: Unlike *z(u)* in German, the infinitival particle *te* always occurs on the verb that is immediately dependent on the *zu*-selector even though the order in the verb cluster is usually strictly ascending. In

³⁰ Additional motivation for a derivational account (cf. Arregi and Nevins 2012) comes from impoverishment patterns. It is much more frequent that the features selected by V1 are deleted than those selected by V2; this makes sense if the exponent selected by V2 is attached first and then, the exponent selected by V1 is deleted in case of a clash. This is the pattern of the IPP-construction (in the 123 order, where impoverishment can be considered a local repair), as well as of the interactions discussed in Höhle (2006, 68, ex. 40; 70, ex. 48) where the gerund selected by V1 is deleted and V3 appears in the *ge*-infinitive selected by V2. The most prominent counter-example is the PPI-construction, where the selectional requirements of V2 are deleted; another case is mentioned in Höhle (2006, 69, ex. 41) from Barchfeld where V1 selects *zu*+gerund, V2 a *ge*-infinitive, and V3 appears as *zu*+gerund. Interestingly, Anita Steube (p.c.) reports the opposite judgment for Steinbach-Hallenberg in this configuration: V3 appears as a *ge*-infinitive, while *zu*+gerund undergo deletion (alternatively, faithful realization is possible under the 132 order):

- (i) doas de ned bruchsd₁ könd₂ ge-säng₃/ge-säng₃ zu kön-e₂ ...
 that you not need._{2SG} can._{SUP} GE-sing._{INF}/GE-sing._{INF} to can-GER
 'that you need not be able to sing ...' Steinbach-Hallenberg

The fact that selectional restrictions seem to be checked under linear adjacency (recall Sect. 5.4) also argues for a derivational account. It furthermore predicts that cumulativity of gerund and *ge*-infinitive should only be possible if the *ge*-infinitive is affixed first, i.e., is selected by V2; in the reverse order, the *ge*-infinitive would not be adjacent to the stem if the gerund has already been attached; unfortunately, I have not been able to find a relevant example, which is arguably related to the fact that the most prominent gerund-selecting verb 'will' cannot be embedded.

(88), repeated from (12), *te*, selected by the complementizer *zonder* ‘without’, occurs on V1:

- (88) *zonder* het boek **te** moeten₁ kunnen₂ lezen₃
without the book to must.INF can.INF read.INF
 ‘without having to be able to read the book’ 123 *Standard Dutch*

The Standard Dutch pattern can be derived if the placement of *te* is the result of either Agree between V and the functional head hosting the features for *te*/the selector of the non-finite morphology as in Adger (2003) and Wurmbrand (2012) or Lowering, viz. downward head-movement (an operation ultimately derived from the affix hopping transformation of early generative grammar, cf. Embick and Noyer 2001). The first solution seems simpler, especially if there is a direct Agree relationship between selector and verb, but for reasons of compatibility with what I have been assuming for German and dialectal data to be introduced presently, I adopt a slightly more complex approach: I postulate a functional head F that hosts the features for *te*. For the case at hand it does not matter whether these features originate there and are checked against selectional features of the selector or whether F receives its features via Upward Agree from the selector. I further assume that F undergoes Lowering. Since this operation is sensitive to hierarchical relations, F will invariably end up on the highest verb of the verb cluster, irrespective of the order in the verb cluster, cf. (89) (I assume for expository purposes that the object has been scrambled out of the lexical VP, but alternative characterizations of the Dutch verb cluster would also work for present purposes):

- (89) *te*-placement in Standard Dutch

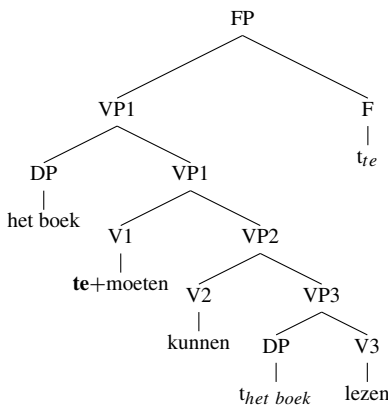

The difference between Standard Dutch and German w.r.t. displacement thus lies in the way the non-finite morphology is associated with the verb at PF.

In addition to the parallelism with German, another argument for a separate functional head for *te* comes from varieties where *te* evidently can remain an independent element: It can occur before a verbal complex with 231 order, cf. (90a/b) or before the object in (90c):

- (90) a. mee Valere **te** willen₂ Marie dienen boek geven₃ een₁
with Valere to want.INF Mary that book give.INF have.INF
 ‘with Valere having wanted to give Mary that book’
West Flemish, Haegeman (1998, 276)
- b. Die banke moes oop gewees het, om dit gister **te** kan₂ betaal₃
the bank should open been have to it yesterday to can.INF pay.INF
 het₁.
have.INF
 ‘In order to have been able to pay for it yesterday, the bank would have had to be open.’
Afrikaans, Donaldson (1993, 367)
- c. hest volk genug **te** heu in schuur bringen?
have.2SG people enough to hay in barn bring.INF
 ‘Do you have enough people to bring the hay into the barn?’
Gronings, Zwart (1993, 103)

To capture this variation, all that is needed is the assumption that no Lowering takes place in these varieties (to account for the placement of *te* in descending orders in these varieties, where *te* precedes V1, one can assume that parts of the VP are moved to a position above *te*, cf. Haegeman 1998, 289f.). An approach that relies on direct Agree between the selector and the governed verb has nothing to say about the data in (90).³¹

7.2 Finite morphology in German

The placement of non-finite morphology in German and its varieties can be systematically described with the assumptions introduced above: Non-finite morphology is

³¹ Interestingly, there is also a significant amount of displacement in Dutch dialects, which, however, displays different patterns than in German. As shown in Pots (2017a, b) *te* can occur too high as well as too low. The first case, referred to as *te*-raising, is analyzed as an instance of clitic climbing (*te* is selected by V1):

- (i) niet {te} hoeven₁ {te} gaan₂ voetballen₃
not to have.to.INF to go.INF play.football
 ‘... not having to go play football’

The second case, so-called *te*-lowering, is analyzed as resulting from spreading + optional deletion (cf. the Upward Agree analysis of parasitic participles in Sect. 1 below; the so-called *te*-shift discussed in Zwart 1993, 103 is arguably also a case of *te*-lowering):

- (ii) Anne zegt op haar stoel {te} willen₁ {te} blijven₂ {te} zitten₃.
Anne says.3SG on her chair to want.INF to remain.INF to sit.INF
 ‘Anne says she wants to remain seated on her comfortable chair.’

I will have nothing to say about displacement in Dutch as the patterns seem substantially different; the mechanisms required to capture them will thus be quite different from what was proposed above for German.

For the geographical distribution of the various options when two *te*-infinitives are selected, see Barbiers et al. (2008, 33). Interestingly, displacement also seems to be marginally possible in Dutch ascending present participle clusters, see Hoeksema (1993), although at least in earlier stages of the language, non-displacement was possible as well in that construction.

8 Conclusion

I have argued that displaced non-finite morphology in German results from a conflict between the head-finality of the German VP and the possibility of head-initial verb clusters. More concretely, I have proposed that non-finite morphology is inserted into designated functional heads that are linearized after their VP-complement. Importantly, the morphology is placed by means of Local Dislocation, a late PF-operation, which ensures that placement will apply to the surface order in the verb cluster. Since Local Dislocation is constrained by adjacency, the non-finite morphology always attaches to the last verb in the complement of the selector. If the verb immediately dependent on the selector is not last in the selector's complement, we find displacement.

The phenomenon provides a straightforward argument for post-syntactic morphology and crucially against pre-syntactic morphology: First, the placement of non-finite morphology is not solely governed by hierarchical relations but crucially affected by linear notions such as adjacency. Second, displacement has no semantic effects, which also proves problematic for approaches that derive displacement by means of syntactic XP-movement. Third, the restrictions on displacement follow from the interaction of the selectional properties of the vocabulary items, which are checked under linear adjacency. Furthermore, I have shown that the phenomenon favors a derivational approach to the morphology-syntax interface as within Distributed Morphology, while alternative realizational models are confronted with both conceptual and empirical shortcomings.

Footnote 34 continued

Apparently, F1 (hosting the *gerund*) and F2 (hosting the *ge*-infinitive) undergo Lowering in this dialect. According to Höhle (2006), faithful realization seems to be confined to this particular dialect; I have at this point nothing to offer to account for this kind of cross-linguistic variation.

Another case I am aware of involves certain three-verb clusters in Swiss German with 123 order where V1 is a perfective auxiliary, V2 is either 'hear', 'help', 'teach/learn', 'stop' or 'begin' (and V3 is a bare infinitive). While V2 canonically appears in the infinitive (thus the IPP-form), more recently, the use of the participle on V2 can be observed quite often (cf. also Löttscher 1978, 3). Here is an example with V2 = *ufhöre* 'stop' (for a Swabian example with V2 = 'help', see Heilmann 1999, 63, ex. 3h; for examples in Afrikaans with V2 = 'come' or 'make', cf. De Vos 2003, 521; for examples in earlier stages of German with V2 = 'hear' and 'let', see Jäger 2018):

- (ii) *dass dis Herz vo sälber hät₁ ufghört₂ schlah₃*
that your heart by itself have.3SG stop.PTCP beat.INF
 'that your heart has stopped beating by itself'

Swiss German

<http://gaestebuch.007box.de/index.php?gbname=gb10323&pos=110>, accessed December 30,

2015

Thus, F1 hosting the participial features seems to undergo Lowering. Lowering may also be necessary to account for the participle on V2 in the 213 order in Example (14e) above. Without Lowering, the participle would be displaced to V3.

Another potential case of faithful realization involves clusters with V1 = perfective auxiliary and a *zu*-selecting verb as V2. One can find such examples in Bernese German in 123 order with the morphology faithfully realized. However, with *zu*-infinitives, the faithful realization could be due to extraposition, see footnote 22 above and Salzmann (2019). Extraposition of VP3 as the source for faithful realization is unlikely for (i) and (ii) because extraposition of infinitives without *zu* is generally taken to be impossible (but see Zwart 2007, 83f. for a proposal along these lines).

Finally, variation in the placement of verbal morphology both across and within languages can be captured straightforwardly by differences in the way the functional heads and their content are associated with the verbal stem: either by means of Lowering, which ensures faithful realization of selectional properties, or by means of Local Dislocation, which can lead to displacement.

Acknowledgements This research has been supported by the SNSF-Grant PA00P1_136379/1 and the DFG-Grant SA 2646/1-1. Earlier versions of this research were presented at the DGfS in Potsdam (March 2013), at the University of Tübingen (June 2013), at the University of Leipzig (June 2013), at the workshop on Swiss German syntax in Arezzo (September 2013), at the CRISSP seminar in Brussels (June 2014), at SinFonJA in Graz (September 2014), at CGSW 29 in York (September 2014), at the workshop on dialect syntax: state of the art in Frankfurt (December 2014), at the workshop on verb clusters in Amsterdam (May 2015), at the Morphology Days in Leuven (December 2015), at NELS 47 at UMass (October 2016), at CGSW 31 in Stellenbosch (December 2016), at the University of Göttingen (January 2017), at GLOW 40 in Leiden (March 2017), at the University of Potsdam (May 2017), and at the University of Stuttgart (May 2018). I thank the audiences for helpful feedback, in particular Sjef Barbiers, Hans Bennis, Theresa Biberauer, Ellen Brandner, Claudia Bucheli, Jeroen van Craenenbroeck, Silke Fischer, Jürg Fleischer, Doreen Georgi, Fabian Heck, Lotte Hendriks, Anke Himmelreich, Roland Hinterhölzl, Daniel Hole, Tony Kroch, Guido Mensching, Walt Detmar Meurers, Gereon Müller, Henk van Riemsdijk, Oliver Schallert, Guido Seiler, Markus Steinbach, Wolfgang Sternefeld, Tanja Temmerman, Jochen Trommer, Philipp Weißer, Guido Vanden Wyngaerd, Hedde Zeijlstra, Eva Zimmermann, and Jan-Wouter Zwart. I am very grateful to Hans Ulrich Schmid for help with the Middle High German data, to Martin Graf and Christoph Landolt from the Idiotikon for help with the Swiss German data and to Olivier Bonami for discussions about realizational morphology. Particular thanks go to Anita Steube for generously sharing her native speaker intuitions and insights about the dialect of Steinbach-Hallenberg. The paper has been significantly improved by comments of three anonymous JCGL-reviewers. Finally, I would like to thank the Editor in Chief, Susi Wurmbrand, for support and enthusiasm for my project and her valuable suggestions on different versions of this paper. The usual disclaimers apply.

Appendix: Reconciling German displacement with parasitic participles

There is one displacement-like phenomenon within Germanic that at first sight seems incompatible with the assumptions I have made for the placement of non-finite morphology, viz., parasitic participles in Norwegian/Swedish/Faroese and Frisian (for parasitic morphology in Dutch varieties, see Barbiers et al. 2008, 38). In this construction the participle morphology selected by V1 is not only realized on V2 but also (optionally) on V3, although V2 selects an infinitive, see Wurmbrand (2012, 132):

- (92) a. Jeg hadde₁ villet₂ lest₃ boka.
I had want.PTCP read.PTCP book
 ‘I would have liked to read the book.’ Norwegian
- b. Ik ben tankber dat ik sa folle dien₃ kinnen₂ haw₁.
I am thankful that I so much do.PTCP can.PTCP have
 ‘I am grateful that I could do so much.’ Frisian

Parasitic morphology in these languages differs in a number of ways from displacement in German and will thus require a partly different treatment.³⁵

³⁵ First, displacement in German involves various types of non-finite forms, while in the other languages it is limited to participles. Second, only German features default forms (infinitives, supines) on V2 (there is no IPP-effect in the other languages). Third, displacement in German is limited to right-branching clusters,

But since it is a prominent ‘misplacement’-phenomenon within Germanic, a theory about the placement of non-finite morphology should ideally be able to account for both displacement in German and parasitic participles.

This seems difficult at first sight because the phenomenon has been taken as evidence for an Agree approach where the verbs start out with unvalued features that are valued via Upward Agree by the selecting heads, cf. Wurmbrand (2012, 136–139). She assumes that functional clausal heads (such as T, Mod, Asp etc.) have an interpretable T(ense)-feature, which is typically valued; the value corresponds to the semantic value of the head, viz., PAST, MODAL, PERFECT etc. Furthermore, all verbal heads have an uninterpretable T-feature, which is typically unvalued. Since it is unvalued, it has to undergo Agree with the closest valued feature. The values of the uT-feature then determine their morphological realization. In the case of participles, the verb’s [uT]-feature is valued as [uT:perf] by the auxiliary. In three-verb clusters there is normally an intervening head Inf assigning the Inf-feature to V3 so that we obtain faithful realization, cf. (93a); in the parasitic construction, which is taken to be a restructuring construction with less structure (Wiklund 2001), Inf is absent and the [perf]-value of the Aux/V1 is thus copied onto V3 as well, cf. (93b):

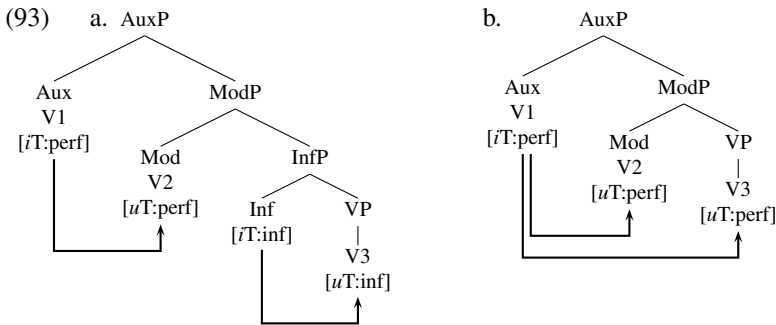

Thus, in pretheoretic terms, the participial feature ‘spreads’ to another dependent verb in the auxiliary’s c-command domain. This can in fact involve several dependent verbs in Frisian and the Scandinavian languages, see Den Dikken and Hoekstra (1997, 1068) (while in German the selected morphology always occurs only once)³⁶:

- (94) hy soe₁ it dien₅ kinnen₄ wollen₃ ha₂
he would it do.PTCP can.PTCP want.PTCP have.INF
 ‘He would have liked to be able to do it.’

Frisian

Footnote 35 continued

while parasitic morphology in Frisian occurs in left-branching/descending orders (right-branching/ascending structures only occur with *te*-infinitives in Frisian, recall Sect. 5.3.1). Fourth, Frisian also has upward displacement (the requirements of V3 are realized on V2), see Wurmbrand (2012, 139).

³⁶ There are a few attested examples of the PPI-construction in earlier stages of German where V2 appears as a participle as well—basically as in Frisian and the Scandinavian languages, see Jäger (2018). At this point, I do not have sufficient information about the construction to assess the possible implications of these examples.

Given that this goes beyond feature-checking in head-complement structures, (94) clearly provides a strong argument in favor of the Agree-approach but seems incompatible with what I have been assuming so far. Since it would be desirable to obtain a unified approach to the placement of non-finite morphology at least within Germanic, I will sketch a proposal that attempts to reconcile parasitic participles with displacement in German. Note that it is not my intention to do justice to all aspects of the parasitic construction as this is beyond the scope of this paper; nor do I preclude the possibility that parasitism has a very different source, e.g., involves feature-copying at PF as proposed in Wiklund (2001).

First, I continue to assume that each verb (including auxiliaries) has an F-head above it for inflectional features. Second, this F-head then receives features from the superordinate verb via Agree as in Wurmbrand (2012), a possibility that I have been alluding to, but which would not have had any consequences. Third, languages/varieties differ from each other in the way the content of the functional heads is combined with the verbal stem: This can involve Local Dislocation as in German, which may lead to displacement. Or it involves Lowering so that we obtain faithful realization; this is what we find in Standard Dutch, and, as I will now show, in Frisian/Norwegian/Swedish.

The derivation of parasitic participles under these assumptions thus proceeds as follows: There are F-heads above the modal(s) and the lexical verb which receive the [uT:perf]-value from the auxiliary. The F-heads are then lowered onto the verbs:

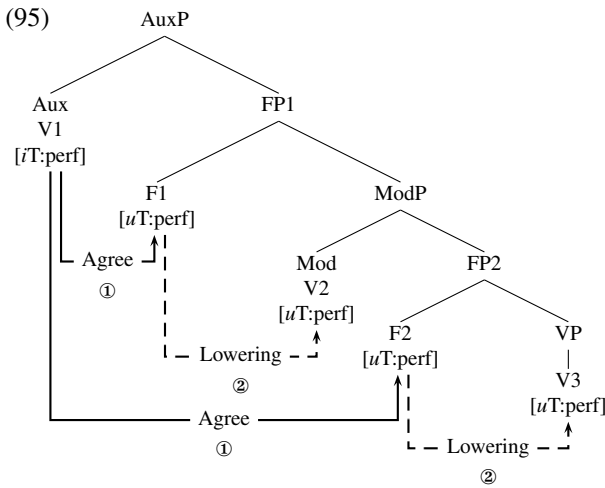

There remain two challenges for this proposal: First, given that the lower participle is not interpreted but both participles arise via feature copying in syntax, the upper participle cannot contribute to the interpretation of the present perfect either (cf. Den Dikken and Hoekstra 1997; Wurmbrand 2012). Consequently, contrary to what I have been assuming, the perfect/past semantics have to arise in a different way (this also affects my argument from semantic interpretation in Sect. 4 above), thus either from the auxiliary alone or from some other silent functional head above FP1, while FP1/FP2 only take care of the morphological realization. Second, spreading in German needs to be prevented because if the structure were the same, we would also expect parasitic

participles in left-branching clusters (arguably not in ascending clusters because the two F-heads would be identical and thus reduced by haplology):

- (96) dass ich ihn { *gelesen₃/✓lesen₃ } gesehen₂ habe₁
 that he him read.PTCP/read.INF see.PTCP have.ISG
 ‘that I saw him read’ Standard German

One way of avoiding this is to assume that while in the parasitic construction infinitive-selecting verbs such as modals never Agree with the F-head below them (as in (95) above), they do in German. This requires an [iT]-feature on modals in German and its optional absence in Scandinavian/Frisian. Since the modal is a closer goal for F2 in (95), F2 will be valued as [+Inf] in German, thereby blocking the spreading of participle features from V1.

Needless to say, there remain a number of open issues; but I hope I have been able to show that the prospects of reconciling parasitic participles with displacement in German are quite good.

References

- Abeillé, Anne, Olivier Bonami, Danièle Godard, and Jesse Tseng. 2006. The syntax of French à and de: an HPSG analysis. In *Syntax and semantics of prepositions*, ed. Patrick Saint-Dizier, 147–162. Dordrecht: Springer.
- Abels, Klaus. 2016. The fundamental left-right asymmetry in the Germanic verb cluster. *The Journal of Comparative Germanic Linguistics* 19 (3): 179–220.
- Adger, David. 2003. *Core syntax. A minimalist approach*. Oxford: Oxford University Press.
- Arregi, Karlos, and Andrew Nevins. 2012. *Morphotactics. Basque auxiliaries and the structure of spellout*. Dordrecht: Springer.
- Bader, Markus, and Tanja Schmid. 2009. Verb clusters in Colloquial German. *The Journal of Comparative Germanic Linguistics* 12 (3): 175–228.
- Bader, Thomas. 1995. Missing and misplaced z’ in Bernese Swiss German. In *Topics in Swiss German syntax*, ed. Zvi Penner, 19–28. Bern: Peter Lang.
- Barbiers, Sjef. 2005. Word order variation in three verb clusters and the division of labor between generative linguistics and sociolinguistics. In *Syntax and variation. Reconciling the biological and the social*, ed. Leonie Cornips, and Karen P. Corrigan, 233–264. Amsterdam: John Benjamins.
- Barbiers, Sjef, Johan van der Auwera, Hans Bennis, Eefje Boef, Gunther de Vogelaer, and Margreet van der Ham. 2008. *Syntactic atlas of the Dutch dialects*, vol. 2. Amsterdam: Amsterdam University Press.
- Barss, Andrew. 1986. *Chains and anaphoric dependencies*. Doctoral dissertation, MIT.
- Bech, Gunnar. 1963. Grammatische Gesetze im Widerspruch. *Lingua* 12 (3): 291–299.
- Bech, Gunnar. 1983. *Studien über das deutsche verbum infinitum*. Tübingen: Niemeyer.
- Behaghel, Otto. 1923–1932. *Deutsche syntax. Eine geschichtliche Darstellung*. Heidelberg: Carl Winter.
- Bickel, Balthasar, Goma Banjade, Martin Gaenszle, Elena Lieven, Netra Paudyal, Ichchha P. Rai, Manoj Rai, Novel K. Rai, and Sabine Stoll. 2007. Free prefix ordering in Chintang. *Language* 83 (1): 43–73.
- Bölsing, Friedrich. 2011. *Niederdeutsche Sprachlehre: Plattdeutsch im Kirchspiel Lindhorst, Schaumburg-Lippe*. Hildesheim: Olms.
- Bruening, Benjamin. 2017. *Consolidated morphology. A non-distributed, purely syntactic theory of morphology*. Ms. University of Delaware.
- Chomsky, Noam. 1995. *The minimalist program*. Cambridge, MA: MIT Press.
- Comrie, Bernard, and Uli Frauenfelder. 1992. The verbal complex in Gurinerdeutsch. *Linguistics* 30 (6): 1031.
- Cooper, Kathrin E. 1995. *Topics in Zurich German syntax*. Groningen: Germanistisch Instituut.

- De Vos, Mark. 2003. Past participles in Afrikaans dialects and Dutch. In *Proceedings of the 22nd West Coast conference on formal linguistics*, ed. Gina Garding, and Mimū Tsujimura, 519–532. Somerville, MA: Cascadilla.
- Demske-Neumann, Ulrike. 1994. *Modales Passiv und tough movement. Zur strukturellen Kausalität eines syntaktischen Wandels im Deutschen und Englischen*. Tübingen: Niemeyer.
- Den Dikken, Marcel, and Eric Hoekstra. 1997. Parasitic participles. *Linguistics* 35 (6): 1057–1090.
- Donaldson, Bruce C. 1993. *A grammar of Afrikaans*. Berlin: Mouton de Gruyter.
- Ebert, Robert Peter, Oskar Reichmann, Hans-Joachim Solms, and Klaus-Peter Wegera. 1993. *Frühneuhochdeutsche Grammatik*. Tübingen: Niemeyer.
- Embick, David. 2007. Linearization and local dislocation: Derivational mechanics and interactions. *Linguistic Analysis* 33 (3–4): 303–336.
- Embick, David. 2015. *The morpheme. A theoretical introduction*. Boston/Berlin: De Gruyter Mouton.
- Embick, David, and Rolf Noyer. 2001. Movement operations after syntax. *Linguistic Inquiry* 32 (4): 555–595.
- Grimm, Jacob. 1837. *Deutsche Grammatik. Vierter Theil*. Göttingen: Dieterichsche Buchhandlung.
- Haegeman, Liliane. 1998. V-positions and the middle field in West Flemish. *Syntax* 1 (3): 259–299.
- Haegeman, Liliane, and Henk van Riemsdijk. 1986. Verb projection raising, scope, and the typology of rules affecting verbs. *Linguistic Inquiry* 17 (3): 417–466.
- Haider, Hubert. 2010. *The syntax of German*. Cambridge: Cambridge University Press.
- Haider, Hubert. 2011. Grammatische Illusionen—lokal wohlgeformt—global deviant. *Zeitschrift für Sprachwissenschaft* 30 (2): 223–257.
- Halle, Morris, and Alec Marantz. 1993. Distributed morphology and the pieces of inflection. In *The view from Building 20. Essays in linguistics in honour of Sylvain Bromberger*, ed. Ken Hale, and Samuel Jay Keyser, 111–176. Cambridge, MA: MIT Press.
- Harizanov, Boris, and Vera Gribanova. 2014. Inward-sensitive contextual allomorphy and its conditioning factors. In *Proceedings of the 43rd annual meeting of the North East Linguistic Society*, vol. 1, ed. Hsin-Lun Huang, Ethan Poole, and Amanda Rysling, 155–166. Amherst, MA: GLSA.
- Heilmann, Axel. 1999. *Die VP im Schwäbischen*, Doctoral dissertation. University of Stuttgart.
- Hinterhölzl, Roland. 2009. The IPP-effect, phrasal affixes and repair strategies in the syntax-morphology interface. *Linguistische Berichte* 2009 (218): 191–215.
- Hinterhölzl, Roland. 2018. Implications of displaced affixes for the analysis of non-finite morphology and the headedness of the VP in German. In *Syntax aus Saarbrücker Sicht 2. Beiträge der SaRDIs-Tagung zur Dialektsyntax*, ed. Augustin Speyer, and Philipp Rauth, 69–88. Stuttgart: Steiner.
- Hodler, Werner. 1969. *Berndeutsche syntax*. Bern: Francke Verlag.
- Hoeksema, Jack. 1993. Tegenwoordig-deelwoordgroepen I: Een merkwaardig randgeval. *Tabu* 23 (3): 171–174.
- Hoeksema, Jack. 1995. Nevenschikking onder te. *Tabu* 25 (3): 156–157.
- Höhle, Tilman N. 2006. Observing non-finite verbs: some 3V phenomena in German-Dutch. In *Form, structure, and grammar. A festschrift presented to Günther Grewendorf on occasion of his 60th birthday*, ed. Patrick Brandt, and Eric Fuß, 55–77. Berlin: Akademie Verlag.
- Jäger, Agnes. 2018. On the history of the IPP construction in German. In *Clause structure and word order in the history of German*, ed. Agnes Jäger, Gisella Ferraresi, and Helmut Weiß, 302–323. Oxford: Oxford University Press.
- Kramer, Ruth. 2010. The Amharic definite marker and the syntax-morphology interface. *Syntax* 13 (3): 196–240.
- Lötscher, Andreas. 1978. Zur Verbstellung im Zürichdeutschen und in anderen Varianten des Deutschen. *Zeitschrift für Dialektologie und Linguistik* 45: 1–29.
- Merkes, Peter Wilhelm. 1895. *Der neuhochdeutsche Infinitiv als Teil einer umschriebenen Zeitform: Historisch-grammatische Betrachtungen*, Doctoral Dissertation. University of Göttingen.
- Meurers, Walt Detmar. 2000. *Lexical generalizations in the syntax of German non-finite constructions*, Doctoral Dissertation. Universität Tübingen.
- Miller, Philip H. 1992. *Clitics and constituents in phrase structure grammar*. New York: Garland.
- Müller, Gereon. 2010. Movement from verb-second clauses revisited. In *Language and logos. A Festschrift for Peter Staudacher*, ed. Thomas Hanneforth, and Gisbert Fanselow, 97–128. Berlin: Akademie Verlag.
- Müller, Stefan. 2003. Solving the bracketing paradox: An analysis of the morphology of German particle verbs. *Journal of Linguistics* 39 (2): 275–325.

- Pots, Cora. 2017a. *Displaced morphology in Dutch: Variation in non-finite verb clusters*. Paper presented at ConSOLE XXV—Leipzig, January 6, 2017.
- Pots, Cora. 2017b. Te-raising is clitic climbing. In *Linguistics in the Netherlands 2017*, ed. Sander Lestrade, and Bert Le Bruyn, 127–141. Amsterdam: John Benjamins.
- Reis, Marga. 1979. Ansätze zu einer realistischen Grammatik. In *Befund und Bedeutung. Zum Verhältnis von Empirie und Interpretation in Sprach- und Literaturwissenschaft*, ed. Klaus Grubmüller, Ernst Hellgardt, Heinrich Jellissen, and Marga Reis, 1–21. Tübingen: Niemeyer.
- Sabel, Joachim. 2000. Das Verbstellungsproblem im Deutschen: Synchronie und Diachronie. *Deutsche Sprache* 28: 74–99.
- Salzmann, Martin. 2011. Resolving the movement paradox in verb projection raising. In *Empirical issues in syntax and semantics*, vol. 8, ed. Olivier Bonami, and Patricia Cabredo Hofherr, 453–485. Paris: CNRS.
- Salzmann, Martin. 2013a. New arguments for verb cluster formation at PF and a right-branching VP. Evidence from verb doubling and cluster penetrability. *Linguistic Variation* 13 (1): 81–132.
- Salzmann, Martin. 2013b. Rule ordering in verb cluster formation: On the extraposition paradox and the placement of the ininitial particle *te/zu*. In *Rule interaction in grammar. Vol 90 of Linguistische Arbeitsberichte*, ed. Fabian Heck, and Anke Assmann, 65–121. Leipzig: University of Leipzig.
- Salzmann, Martin. 2016. Displaced morphology in German—Evidence for post-syntactic morphology. In *Replicative processes in grammar Vol. 93 of Linguistische Arbeitsberichte (LAB)*, ed. Katja Barnickel, Matías Guzmán-Naranjo, Johannes Hein, Sampson Korsah, Andrew Murphy, Ludger Paschen, Zorica Puškar, and Joanna Zaleska, 401–446. Leipzig: Leipzig University.
- Salzmann, Martin. 2019. On the limits of variation in Continental West-Germanic verb clusters. Evidence from VP-stranding, extraposition and displaced morphology for the existence of clusters with 213 order. *Journal of Comparative Germanic Linguistics* 22 (1): 55–108. <https://doi.org/10.1007/s10828-019-09104-x>.
- Schallert, Oliver. 2019a. A note on misplaced or wrongly attached *zu* ‘to’ in German. *Journal of Germanic Linguistics* (To appear).
- Schallert, Oliver. 2019b. Portrait of the clitic as a young affix: Infinitivisches *zu* im Niemandsland zwischen Morphologie und Syntax. In *Syntax aus Saarbrücker Sicht 3. Beiträge der SaRDtS-Tagung zur Dialektsyntax*, ed. Augustin Speyer, and Julia Hertel. Stuttgart: Steiner.
- Schmeller, Johann Andreas. 1821. *Die Mundarten Bayerns grammatisch dargestellt*. München: Karl Thiene-mann.
- Schmid, Tanja. 2005. *Infinitival syntax. Infinitivus pro participio as a repair strategy*. Amsterdam: Ben-jamins.
- Schmid, Tanja, and Ralf Vogel. 2004. Dialectal variation in German 3-verb clusters: A surface-oriented optimality theoretic account. *The Journal of Comparative Germanic Linguistics* 7 (3): 235–274.
- Seiler, Guido. 2002. Prepositional dative marking in Upper German: A case of syntactic microvariation. In *Syntactic microvariation*, ed. Sjeff Barbiers, Leonie Cornips, and Susanne Van-derKleij, 243–279. Amsterdam: Meertens Institut.
- Sperschneider, Heinz. 1959. *Studien zur Syntax der Mundarten im östlichen Thüringer Wald*. Marburg: N. G. Elwert Verlag.
- Steil, Claudia. 1989. *Untersuchungen zum Verbalkomplex im Schwäbischen*, MA Thesis. University of Tübingen.
- Steube, Anita. 1995. Flexibler Umgang mit funktionalen Kategorien: Unterstützung aus einer Mundartgram-matik. In *Chronologische, areale und situative Varietäten des Deutschen in der Sprachhistographie. Festschrift für Rudolf Große*, ed. Gotthard Lerchner, Marianne Schröder, and Ulla Fix, 421–434. Frankfurt: Peter Lang.
- Stiebels, Barbara, and Dieter Wunderlich. 1994. Morphology feeds syntax: The case of particle verbs. *Linguistics* 32 (6): 913–968.
- Stump, Gregory T. 2001. *Inflectional morphology: A theory of paradigm structure*. Cambridge: Cambridge University Press.
- Vogel, Ralf. 2009. Skandal im Verbkomplex. Betrachtungen zur scheinbar inkorrekten Morphologie in infiniten Verbkomplexen des Deutschen. *Zeitschrift für Sprachwissenschaft* 28 (2): 307–346.
- Weber, Albert. 1987. *Zürichdeutsche Grammatik: ein Wegweiser zur guten Mundart*. Zürich: Schweizer Spiegel Verlag.
- Weise, Oskar. 1900. *Syntax der Altenburger Mundart*. Leipzig: Breitkopf u. Härtel.

- Wiklund, Anna-Lena. 2001. Dressing up for vocabulary insertion: The parasitic supine. *Natural Language & Linguistic Theory* 19 (1): 199–228.
- Williams, Edwin. 2004. The structure of clusters. In *Verb clusters: A study of Hungarian, German, and Dutch*, ed. Katalin É. Kiss, and Henk van Riemsdijk, 173–201. Amsterdam: John Benjamins.
- Wurmbrand, Susi. 2004a. Syntactic vs. post-syntactic movement. In *Proceedings of the 2003 annual conference of the Canadian Linguistic Association*, eds. Sophie Burrelle and Stanca Somesfalean, 284–295. Montreal: Université du Québec à Montréal.
- Wurmbrand, Susi. 2004b. Two types of restructuring—lexical vs. functional. *Lingua* 114 (8): 991–1014.
- Wurmbrand, Susi. 2004c. West Germanic verb clusters: The empirical domain. In *Verb clusters: A study of Hungarian, German, and Dutch*, ed. Katalin É. Kiss, and Henk van Riemsdijk, 43–85. Amsterdam: John Benjamins.
- Wurmbrand, Susi. 2007. How complex are complex predicates? *Syntax* 10 (3): 243–288.
- Wurmbrand, Susi. 2012. Parasitic participles in Germanic: Evidence for the theory of verb clusters. *Taal en Tongval: Tijdschrift voor Taalvariatie* 64 (1): 129–156.
- Wurmbrand, Susi. 2013. *Scandalous orders in German verb clusters: A corpus view*. Paper presented at the 19th Germanic Linguistics Annual Conference, Buffalo.
- Wurmbrand, Susi. 2014. Tense and aspect in English infinitives. *Linguistic Inquiry* 45 (3): 403–447.
- Wurmbrand, Susi. 2017. Verb clusters, verb raising, and restructuring. In *The Blackwell companion to syntax*, 2nd ed, ed. Martin Everaert, and Henk van Riemsdijk. Oxford: Wiley-Blackwell.
- Zwart, Jan-Wouter. 1993. *Dutch syntax. A minimalist approach*, Ph.D. dissertation. University of Groningen.
- Zwart, Jan-Wouter. 2007. Some notes on the origin and distribution of the IPP-effect. *Groninger Arbeiten zur Germanistischen Linguistik* 45: 77–99.

Publisher's Note Springer Nature remains neutral with regard to jurisdictional claims in published maps and institutional affiliations.