

## Switch reference as index agreement

Karlos Arregi · Emily A. Hanink

Received: date / Accepted: date

**Abstract** The grammatical notion of *switch reference* refers to morphological markers that track whether the subjects of two related clauses are coreferent (Jacobsen 1967). We argue in this article for a treatment of switch reference as index agreement, based on the behavior of switch reference in Washo (Hokan/isolate; USA). We propose that switch-reference marking arises as the result of multiple agreement between C in an embedded clause and the referential index values of the subject in that embedded clause as well as the subject in its superordinate clause. The morphemes representing both different and same subject marking are then the exponence of the presence or absence, respectively, of conflict in the featural make up of C. We argue that, unlike alternatives based on coordination, control, or binding, an agreement-based account explains several core properties of this phenomenon in Washo, including the distribution and internal structure of clauses marked for switch reference, as well as the exponence of switch reference in cases of reference overlap. More generally, switch reference in Washo provides evidence that Agree can be bidirectional (downward and upward), as well as for the existence of referential indices as true syntactic objects that participate in syntactic operations.

**Keywords** switch reference, agreement, Upward Agree, referential indices, Washo

### 1 Introduction

The grammatical notion of *switch reference* (SR) refers to morphological marking that tracks whether the subjects of two related clauses are coreferent (Jacobsen 1967; for a recent overview for North American languages see McKenzie 2015). While previous work has argued for the merits of semantic or discursive (Dahlstrom 1982,

---

Karlos Arregi  
E-mail: karlos@uchicago.edu

Emily A. Hanink  
E-mail: emily.hanink@manchester.ac.uk

Stirling 1993, McKenzie 2012) versus syntactic (Finer 1984, 1985, Broadwell 1990, 1997, Watanabe 2000, Camacho 2010, Georgi 2012, Keine 2013, i.a.) treatments of switch reference in different languages, more recent analyses contend that switch reference is in fact a syntactic phenomenon that is best understood as the reflex of agreement (McKenzie 2012, Arregi and Hanink 2018, Clem 2020, Baker and Camargo Souza 2020).<sup>1</sup>

We contribute to this line of research with switch reference data from Washo (Hokan/isolate), a language spoken around Lake Tahoe in the United States.<sup>2</sup> Switch-reference marking in Washo surfaces as the overt *different subject* (DS) suffix *-š* at the right periphery of a verb when the subject in its own clause is referentially distinct from the one in the clause embedding it (Jacobsen 1964:665, 1967, 1998).<sup>3</sup> This can be seen for example in (1), in which the subjects *pro* and *Adele* are referentially distinct, triggering the *-š* morpheme on the embedded verb *sú:bi?* ‘bring’. *Same subject* (SS) marking on the other hand is null, as exemplified in (2), in which the subjects of both clauses are coreferential (*Adele*) and *-š* is absent on the embedded verb *í:gi* ‘see’.<sup>4</sup>

- (1) *Different subject (DS) -š*  
*pro*<sub>i</sub> [ **Adele**<sub>j</sub> díme? sú:bi?-i-š-ge ] di-hámup’ay?-é:s-i  
*pro*<sub>i</sub> [ **Adele**<sub>j</sub> water 3/3.bring-IND-DS-NM.ACC ] 1/3-forget-NEG-IND  
 ‘I<sub>i</sub> remember that Adele<sub>j</sub> brought the water.’<sup>5</sup>

<sup>1</sup> We adopt a standard distinction in the literature between *canonical* switch reference, which tracks reference of arguments (typically, subjects) in different clauses, and *non-canonical* switch reference, which tracks topical or situational continuity (i.a. Dahlstrom 1982, Stirling 1993, McKenzie 2012, 2015). Switch reference in Washo is canonical, as argued in Arregi and Hanink 2018.

<sup>2</sup> Washo is sometimes considered to be part of the Hokan family; see Campbell (1997) and Mithun (1999) for discussion. The uncited data in this article come from fieldwork by Emily Hanink in the Nevada community, largely from trips taking place between 2017 and 2020. The primary collection methods were elicitation tasks in which the speaker was asked to translate a sentence, as well as grammaticality tasks, where the speaker was asked to judge the grammaticality of a given utterance. Examples labeled with ‘Washo Archive’ are taken from the corpus of examples available online at <https://washo.uchicago.edu>.

<sup>3</sup> Although this description is true when both subjects are singular, matters are more complex when plural nominals are involved. See Section 7.

<sup>4</sup> In all examples, we follow the Leipzig Glossing Rules (<https://www.eva.mpg.de/lingua/resources/glossing-rules.php>), and use the following abbreviations: ACC(usative), AP(plicative), CAUS(ative), DEP(endent mood), DIST.FUT (distant future), DS (different subject), DU(al), FUT(ure), INCH(oative), IND(ependent mood), INV(erse), NEG(ative), NM (nominalizer), NOM(inative), OBL(ique), PL(ural), PLUP(perfect), PRO(noun), PROGRESSIVE, PROSP (propsective aspect), PST (past), Q(uestion particle), R(eduplication) (see Yu 2005), REC.PST (recent past), REFL(exive), SG (singular), SS (same subject), UN(expressed object or possessor agreement). The numbers 1, 2, and 3 represent first, second, and third person, respectively. In Washo examples, a prefixed number represents intransitive subject agreement in verbs and possessor agreement in nouns. Transitive verbs have a portmanteau prefix indicating the person of the subject and object, represented as 1/2 (‘one-on-two’), 3/1 (‘three-on-one’), etc. In Bantu examples, NC1, NC2, etc. represent noun classes and SBJ = subject agreement. Examples from previous literature have been adapted to follow these conventions. We use the standardized orthography for Washo adopted in Jacobsen 1964, which largely follows the IPA, though with the following special characters: M [m̥], š [ʃ], and y [j]. Stress is represented with an acute accent.

<sup>5</sup> Washo does not lexicalize a verb ‘remember’; the translation here reflects negation of the verb *hámup’ay?* ‘forget’.

(2) *Same subject (SS) -Ø*

**Adele<sub>i</sub>** [ *pro<sub>i</sub>* daláʔak ʔ-í:gi-yi-Ø-ge ] hámpup'ayʔ-é:s-i  
**Adele<sub>i</sub>** [ *pro<sub>i</sub>* mountain 3/3-see-IND-SS-NM.ACC ] 3/3.forget-NEG-IND  
 'Adele<sub>i</sub> remembers that she<sub>i</sub> saw the mountain.'

Hanink and Bochnak 2018:67

We propose an analysis of switch reference in Washo according to which the different subject (-š) and same subject (-Ø) markers are realizations of embedded C (building on *Finer 1985* and *Watanabe 2000*). More specifically, we propose that the alternation of these morphemes is conditioned by Multiple Agree (*Hiraiwa 2001*) and the resulting presence or absence of feature conflict (*Harbour 2007*) of multiple index feature values on a single head. We argue that embedded C agrees with both the subordinate and superordinate subjects for the value of their referential indices: if the two subjects are distinct and these features do not match, feature conflict arises on C, resulting in the overt exponence of the DS morpheme -š. If both subjects bear the same index value, the absence of feature conflict is realized by the null SS morpheme.

Aside from capturing the data, the proposed analysis leads more broadly to two important results. First, it lends further evidence to the idea that indices are syntactic objects (*Rezac 2004*, *Hicks 2009*, *Kratzer 2009*, *Kennedy 2014*, *Grosz 2015*, *Deal 2017b*, *Hanink 2021*), and may accordingly enter the derivation with features that can participate in agreement operations. Second, it lends support to the need for Upward Agree (*Baker 2008*, *Merchant 2011*, *Bjorkman and Zeijlstra 2019*), as there are certain switch reference configurations obtaining in Washo which preclude the availability of downward probing (see also *Baker and Camargo Souza 2020*; cf. *Clem 2020*). In particular, a typologically unusual feature of Washo is that switch reference is found in complement clauses, providing a novel test case for the above analyses, which are largely designed to account for the more cross-linguistically common switch-reference marking in adjunct clauses.

The structure of this article is as follows. In Section 2, we introduce our structural assumptions about the structure of embedded clauses in Washo in which switch-reference morphology occurs. In Section 3, we present our analysis of switch reference as index agreement. In Section 4, we motivate the need for Upward Agree in our proposal on the basis of complement clauses, and compare this analysis with alternatives in Section 5. Section 6 provides related arguments from adjuncts. In Section 7, we argue on the basis of reference overlap against alternative analyses that attempt to assimilate switch reference to binding or control, and Section 8 concludes.

## 2 Clause structure in Washo

We begin by discussing the structure of the clause types in which switch-reference marking appears in Washo: nominalized clauses and adjuncts. Core to the proposal going forward is that the different subject marker -š in all clause types is a realization of embedded C (see also *Finer 1985*, *Watanabe 2000*), consistent with the morpheme ordering inside embedded clauses. The DS marker appears at the right periphery of embedded clauses, outside of almost all other morphology, excluding only the clausal

nominalizer *-gi/-ge* where applicable. Switch-reference marking is obligatory in both nominalized clauses and adjuncts.

Like matrix clauses, embedded clauses in Washo follow a largely SOV word order. As will become evident throughout this article, a number of embedded clauses come in the form of clausal nominalizations, as seen for example in (1) and (2) above. Notably, despite an identical surface structure, clausal nominalizations can give rise to a variety of interpretations. They are used for example as internally headed relatives (Jacobsen 1964, 1998), the complements of perception verbs (Hanink 2016), as well as the complements of factive verbs (Hanink and Bochnak 2018). Despite differences in interpretation, previous works on clausal nominalizations adopt a unified underlying structure across all construction types (Bochnak and Hanink 2019, Hanink 2021).

In particular, this structure has four key characteristics (Peachey 2006, Hanink 2016). First, D is a nominalization layer that inflects for case (*-gi* for nominative; *-ge* for accusative). Second, C is the locus of switch reference (there are otherwise no overt complementizers in the language; same/different subject marking is the only possible overt realization of C). Third, the head Mood is obligatorily realized by the ‘independent’ mood suffix *-i* in clausal nominalizations (Jacobsen 1964:663), so called because it is used in root clauses, e.g., on *forget* in (3), though also in several types of embedded sentences.<sup>6</sup> (See below for more on mood in Washo.) Finally, T may or may not host tense inflection (see Bochnak 2016 on Washo as an optional tense language). All of these components are reflected in the structure in (4) for the embedded clause in (3), which in this case is the complement of the factive verb *forget*.

- (3) [ háʔaš-ayʔ-i-š-ge ] di-hámup’ayʔ-i  
 [ 3.rain-INT.PAST-IND-DS-NM.ACC ] 1/3-forget-IND  
 ‘I forgot that it rained.’
- (4) *The structure of clausal nominalizations in Washo*

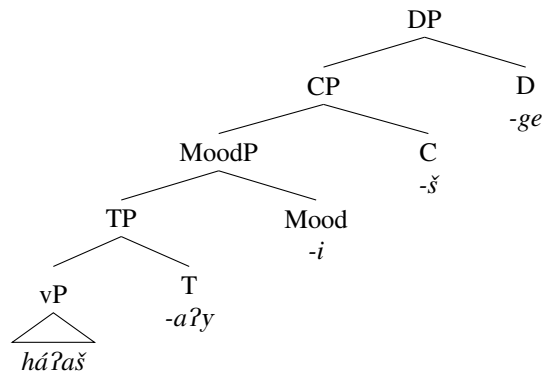

<sup>6</sup> The mood marker *-i* also occurs in other clause types that we do not address in this article, e.g., conditionals.

We note here in particular that no additional assumptions are required for clausal nominalizations interpreted as internally headed relatives, the only type of relative clause available in Washo (Jacobsen 1998). To illustrate this construction, (5) gives an example of an internally headed relative, while (6) gives an example of a ‘headless’ internal relative, which differ only minimally from their headed counterparts, in that the relativized argument is not pronounced:

- (5) *Internally headed relative clause*  
 [ daʔmóʔmoʔ<sub>i</sub> gó:beʔ<sub>j</sub> ʔ-ímeʔ-i-š-ge ]<sub>i</sub> di-sú:dím-i  
 [ woman<sub>i</sub> coffee<sub>j</sub> 3/3-drink-IND-DS-NM.ACC ]<sub>i</sub> 1/3-look.at-IND  
 ‘I’m looking at the woman who is drinking coffee.’
- (6) *‘Headless’ relative clause*  
 [ pro<sub>i</sub> ʔ-íšim-i-š-ge ]<sub>i</sub> 1-í:gi-yi  
 pro<sub>i</sub> 3-sing-IND-DS-NM.ACC 1/3-see-IND  
 ‘I saw (the one<sub>i</sub>) who   <sub>i</sub> was singing.’ Washo Archive

To foreshadow a bit, a reviewer raises the question of whether there is potential covert A'-movement (relativization) in the embedded clause in examples such as these that might have unwanted intervention effects on our Agree-based analysis that follows. There is however good evidence that these clauses do not in fact involve A'-movement, based on the absence of island sensitivity (Hanink 2021). With this in mind, the structure illustrated in (4) is the one we adopt for all clausal nominalizations going forward in this article, including relative clauses.

Beyond nominalizations, switch-reference marking is also found in adjunct clauses as in (7). Such clauses, including for example temporal adjuncts, differ from independent mood clauses such as (3) in that they appear with the ‘dependent’ mood marker *-aʔ*,<sup>7</sup> and may not occur with a nominalizer (Jacobsen 1964:663). Our analysis of the internal structure of adjunct clauses such as (7) is represented in (8).

- (7) [ súkuʔ le-gí:t'iʔ-a-š ] di-gum-suʔúʔuš-leg-i  
 [ dog 3/1-bite-DEP-DS ] 1-REFL-dream-REC.PST-IND  
 ‘I was dreaming while the dog bit me.’
- (8) *The internal structure of adjunct clauses*

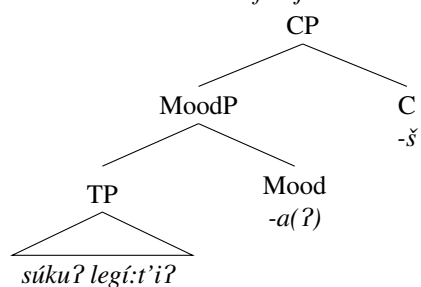

<sup>7</sup> The dependent mood suffix has allomorph *-a* before the different subject maker *-š* (Jacobsen 1964:368), as seen for example in (7).

We now turn to motivate the claim that these clause types are not reduced in any way, but have the full sequence of functional heads that is also found in matrix clauses. We also motivate the proposal that, within this sequence, the switch-reference morpheme is hosted by a high-peripheral functional head that we identify as C, following Finer 1985, Peachey 2006, and Hanink 2016.

First, although Washo is an optional tense language, tense marking is possible both in matrix sentences and in clausal nominalizations as a suffix on the verb. This is illustrated in the following examples with the (in Jacobsen's (1964) terminology) distant future suffix *-gab* and pluperfect *-ayt'i?*:<sup>8</sup>

- (9) *Tense marking in matrix sentences*
- a. gúŋa-he:š béverli wát      ?-é?-**gab**-i  
 where-Q Beverly tomorrow 3-be-**DIST.FUT**-IND  
 'Where will Beverly be tomorrow?' Washo Archive
- b. da-hé:š ?-á?-**áyt'i?**-i      ?ló:t  
 there-Q 3-be-**PLUP**-IND yesterday  
 'Was he there yesterday?' Washo Archive
- (10) *Tense marking in different-subject nominalizations*
- a. [ béverli wát      l-í:gi-**gab**-i-š-gi      ] k'-é?-i  
 [ Beverly tomorrow 1/3-see-**DIST.FUT**-IND-DS-NM.NOM ] 3-be-IND  
 'I will see Beverly tomorrow.'  
 (Lit. 'It is that I will see Beverly tomorrow.') Washo Archive
- b. Adele [ ?um-bašá?-**ayt'i?**-i-š-ge      ] mušé?eš-i  
 Adele [ 2/3-write-**PLUP**-IND-DS-NM.ACC ] 3/3.read-IND  
 'Adele's reading what you wrote.'
- (11) *Tense marking in same-subject nominalizations*
- [ wát      dubáldi? ?ugálishi-**gab**-i-Ø-gi      ] k'-é?-i  
 [ tomorrow five      have.years-**DIST.FUT**-IND-SS-NM.NOM ] 3-be-IND  
 'He will be five years old tomorrow.'  
 (Lit. 'He is [the one] who will be five years old tomorrow.') Washo Archive

That both tense suffixes are found in matrix sentences, as shown in (9), and in nominalizations (*-gab* in (10a) and (11), and *-ayt'i?* in (10b)) is evidence that both matrix sentences and nominalizations have a TP projection. Moreover, the position of the

<sup>8</sup> The nominalized embedded clauses in (10a) and (11) are sentential subjects of the copula *e?*, and are treated as a type of cleft construction in Bochnak et al. 2011 (that they are in subject position is diagnosed by the nominative form of the nominalizer *-gi*; see below). The different-subject marker in (10a) is therefore expected, given that the embedded subject (*béverli* 'Beverly') and the matrix subject (the embedded clause itself) are referentially disjoint. Interestingly, the same construction can also give rise to an interpretation along the lines of an internally headed relative clause in subject position. Such a case is found for example in (11) below (cf. the internally headed relative clause in object position in (10b)), in which the same subject marker is found: this is expected in cases where the relativized argument is the subject, as the two subjects (that of the nominalized clause, and that of the copula) are coreferential. We note moreover that these copular constructions are often interpreted as modal or generic (Bochnak 2015), but the specific modal flavor used in particular examples is sometimes hard to ascertain. The literal translations given in (10a) and (11) should be taken as merely rough approximations of the meanings of these sentences.

different-subject marker *-š* to the right of both tense suffixes in (10) shows that switch reference is hosted by a functional head above T, consistent with our claim that this head is C.

In addition to (optional) tense, one of several mood markers is obligatory in every clause (we discuss the two that are relevant here). The so-called *independent* mood verbal suffix *-i* is found in all matrix clauses as well as in clausal nominalizations, as illustrated in (10)–(11). The *dependent* mood marker *-a?* on the other hand is suffixed to verbs in temporal adjuncts (e.g., (7)) as well as in clauses embedded by non-factive verbs (Hanink and Bochnak 2018).<sup>9</sup> Following Bochnak 2016 and Hanink and Bochnak 2018, we assume that these are the realization of the functional head Mood. As shown by the position of independent mood *-i* between the tense suffixes and different-subject *-š* in (10), MoodP projects immediately above TP and immediately below the head hosting switch-reference marking, which provides further evidence for the high position (C) of the latter.

Finally, the only suffix that follows the switch-reference marker is the nominalizer in clausal nominalizations, i.e., *-gi/-ge* in (10)–(11). We adopt the proposal that this is the realization of a D head whose complement is CP (Peachey 2006, Hanink 2016).<sup>10</sup> Evidence for the nominal status of this suffix is the fact that it alternates for case, which reflects the grammatical role that the embedded clause takes in the superordinate sentence (Jacobsen 1964:666). Specifically, nominative *-gi* surfaces in clausal subjects (henceforth *subject nominalizations*), and accusative *-ge* in complements of verbs and postpositions (henceforth *object nominalizations*):

- (12) *Nominative subject: -gi*  
 [ daʔmóʔmoʔ<sub>i</sub> gó:beʔ<sub>j</sub> ʔ-ímeʔ-i-Ø-**gi** ]<sub>i</sub> la-sú:dím-i  
 [ woman<sub>i</sub> coffee<sub>j</sub> 3/3-drink-IND-SS-NM.NOM ]<sub>i</sub> 3/1-look.at-IND  
 ‘The woman who is drinking coffee is looking at me.’
- (13) *Accusative complement of V: -ge*  
 [ daʔmóʔmoʔ<sub>i</sub> gó:beʔ<sub>j</sub> ʔ-ímeʔ-i-š-**ge** ]<sub>i</sub> di-sú:dím-i  
 [ woman<sub>i</sub> coffee<sub>j</sub> 3/3-drink-IND-DS-NM.ACC ]<sub>i</sub> 1/3-look.at-IND  
 ‘I’m looking at the woman who is drinking coffee.’
- (14) *Accusative complement of P: -ge*  
 [ *pro*<sub>i</sub> gó:beʔ<sub>j</sub> l-émeʔ-áŋaw-i-Ø-**ge** ]<sub>j</sub> -lu  
 [ *pro*<sub>i</sub> coffee<sub>j</sub> 1/3-drink-good-IND-SS-NM.ACC ]<sub>j</sub> -with  
 di-p’ím-iweʔ-giš-i  
 l-go.out-hence-PROG-IND  
 ‘I keep going out because of the coffee that I drank.’  
 ‘With all the coffee I drank, I keep going out.’ Hanink 2021:15

<sup>9</sup> Within *-a?*-marked clauses, switch reference is obligatory in adjuncts but is not observed in clauses embedded by non-factive verbs. Hanink and Bochnak (2018) argue that the clauses in the latter case are somewhat reduced, maximally instantiating MoodPs. The absence of C in their structure explains the lack of switch reference.

<sup>10</sup> Hanink (2021) argues that this morpheme is in fact the spell out of an index head ‘idx’ that occurs with a covert D, rather than D as such. In her account, ID features are hosted on idx, rather than D. We abstract away from that here in the interest of expositional simplicity, as this distinction is not crucial for our purposes; see Hanink 2021 for details.

In addition, these morphemes are used as stand-alone pronouns, as in the following examples:<sup>11</sup>

- (15) a. **gí:** pélew ʔ-íʔiw-i  
**3.PRO.NOM** jackrabbit 3/3-eat-IND  
 ‘He’s eating the jackrabbit.’ Jacobsen 1979:151
- b. **gé:** pélew ʔ-íʔiw-i  
**3.PRO.ACC** jackrabbit 3/3-eat-IND  
 ‘He’s eating it, the jackrabbit.’ Jacobsen 1979:151

Nominals other than pronouns and clausal nominalizations do not display overt case distinctions, as can be seen, for instance, in the fact that *béverli* ‘Beverly’ has the same form in both subject (9a) and object (10a) position. We nevertheless take the data from pronouns and nominalizations as evidence that Washo has a nominative-accusative case system, and that the absence of overt case distinctions in other nominals is due to syncretism.

Finally, we note that, typologically speaking, Washo is unusual in having switch reference so high in the clause, with many switch-reference languages encoding the marker in a lower position (McKenzie 2015:440–442). The Washo data therefore introduce unique challenges to existing analyses. As we show in Section 5.4, this poses a challenge for example to the low coordination analysis of switch reference in Keine (2013), in which switch-reference clauses are claimed to be structurally reduced. Relatedly, we also argue in Section 5 that the fact that switch reference is not hosted by the highest head in nominalizations is problematic for an agreement-based account without upward probing (McKenzie 2012, Clem 2020). In the next section, we put forward our analysis of switch reference as index agreement before returning to a comparison with other analyses in Sections 5 and 7.

### 3 Switch reference as index agreement

In this section we offer an analysis of switch reference in Washo according to which embedded C agrees with the index values of both the superordinate and subordinate subjects via Multiple Agree (Hiraiwa 2000, 2001). The result of this agreement leads to the realization of either the DS or SS marker in the postsyntactic component, whose exponence is sensitive to the presence of feature conflict (on a par with inverse number morphology in the sense of Harbour 2007, 2011) during Vocabulary Insertion. This proposal builds on previous syntactic analyses of switch reference put forward for Washo (Finer 1985, Arregi and Hanink 2018) as well as for other languages (Watanabe 2000, Camacho 2010), which also propose that switch reference morphology is hosted on C, though it differs from previous analyses in the proposal that switch reference is purely the result of (bidirectional) agreement. Recent analyses along the same lines for Panoan languages are offered in Clem 2020 and Baker and Camargo Souza 2020.

<sup>11</sup> Due to regular morphophonology, the vowels in *gi* and *ge* are only long and stressed in independent forms as in (15), but short and unstressed in suffixal form (e.g., in clausal nominalizations). See Jacobsen 1964:309, 312–313.



### 3.1 Core characteristics of switch reference in Washo

We begin by outlining the core characteristics of switch reference in Washo. First, switch reference in Washo operates only across subordinate clause boundaries, and so it does not operate across independent clauses such as those in (16). Although the subjects of the two clauses are referentially distinct, neither sentence is marked with different subject *-š*.<sup>12</sup>

- (16) [ *pro*<sub>i</sub> ʔló:t stór-a l-éy-eweʔ-áyʔig-i ]  
 [ *pro*<sub>i</sub> yesterday store-OBL 1-go-hence-PST-IND ]  
 [ gí:-saʔ wádinguweʔé:beʔ **Ryan**<sub>j</sub> ʔ-íy-eweʔ-ášaʔ-i ]  
 [ 3.PRO-also today **Ryan**<sub>j</sub> 3-go-hence-PROSP-IND ]  
 ‘I went to the store yesterday. Ryan will go today, too.’

Second, switch reference is subject to locality constraints, as illustrated through the fact that it is clause-bound. This can be seen in sentences that involve recursive embedding:

- (17) [[ **súkuʔ**<sub>i</sub> baŋáya ʔ-éʔ-i-š-ge ]<sub>i</sub> ]  
 [[ **dog**<sub>i</sub> outside 3-be-IND-DS-NM.ACC ]<sub>i</sub> ]  
**daʔmóʔmoʔ**<sub>j</sub> bóŋi-yi-š-gi ]<sub>i</sub> p’á:š-ug-i  
**woman**<sub>j</sub> 3/3.call-IND-DS-NM.NOM ]<sub>i</sub> 3.enter-hither-IND  
 ‘The dog<sub>i</sub> who was outside who the woman<sub>j</sub> called came in.’

In (17), the lowest and highest subjects are coindexed and refer to a particular dog, but are referentially distinct from the intermediate subject *daʔmóʔmoʔ* ‘woman’.<sup>13</sup> The crucial observation here is that switch-reference marking in the lowest clause is for different subject, signaling the difference between the referents of the subject of that clause and the subject of the immediately dominating one. The fact that the highest subject is coindexed with the lowest subject is therefore irrelevant for switch-reference marking in the lowest clause.

Third, switch reference tracks subjects only. In the following example, the indirect object (matrix *pro*) is coreferent with the subject in the subordinate clause (embedded *pro*), and they are referentially distinct from the matrix subject *t’é:liwhu* ‘man’:

- (18) [ *pro*<sub>j</sub> bašáʔ té:bił-a l-í:gi-yi-š-ge ]  
 [ *pro*<sub>j</sub> book table-OBL 1/3-see-IND-DS-NM.ACC ]  
**t’é:liwhu**<sub>i</sub> *pro*<sub>j</sub> l-éšil-i  
**man**<sub>i</sub> *pro*<sub>j</sub> 3/1-give-IND  
 ‘The man<sub>i</sub> gave me<sub>j</sub> the book that I<sub>j</sub> saw on the table.’

<sup>12</sup> Truly independent clauses in Washo are rare in connected speech. Generally, the dependent mood maker *-aʔ* is used in order to form connected clauses in a narrative through the use of adjuncts; see Bochnak and Hanink 2019. Like other *-aʔ*-marked adjunct clauses, these connected clauses obligatorily show switch reference.

<sup>13</sup> Specifically, the matrix subject is an internally headed relative clause whose internal head is *súkuʔ* ‘dog’.

If switch reference were sensitive to non-subject arguments, we would expect an intervention effect here as a result of the coreference between the embedded subject and matrix indirect object, triggering same-subject marking in the embedded clause, contrary to fact. The DS marker is obligatory, indicating that only subjects participate in reference tracking.

In the same vein, we point out that switch reference in Washo does not track possessors (see Barany and Nikolaeva 2019 for an analysis of possessor-sensitive switch reference). In (19) for example, the subject in the matrix clause (*woman*) is coreferent with the possessor of the subject in the embedded clause (*pro*). Nevertheless, DS marking obtains, as the embedded subject itself refers to the woman’s pet.

- (19) **daʔmoʔmoʔ<sub>i</sub>** g-ajal ʔ-a:daʔe:ʃib-saʔ-i  
**woman<sub>i</sub>** 3.REFL-house 3/3-fix.up-PROSP-IND  
 [[ **pro<sub>i</sub>** da-guʃuʔ ]<sub>j</sub> ʔ-elʃim-a-**** ]  
 [[ **pro<sub>i</sub>** 3.UN-pet ]<sub>j</sub> 3-sleep-DEP-**DS** ]  
 ‘The woman<sub>i</sub> is going to clean her house while her<sub>j</sub> pet<sub>j</sub> is sleeping.’

Barany and Nikolaeva (2019) show moreover that clauses are more likely to be SS-marked if a possessor in a part-whole relationship is coreferential with another subject. While data on this point are limited, consider the example in (20), which involves inalienable possession.<sup>14</sup> While the possessor of the embedded subject *git-haja* ‘his mouth’ (which surfaces in the form of the subject-oriented reflexive form *git-*) is coreferential with the matrix subject, different subject marking is nevertheless exhibited, indicating that switch reference is not sensitive to this distinction in Washo.

- (20) **pro<sub>i</sub>** ge-mugi:gi-yi [[ **git<sub>i</sub>-haja** ]<sub>j</sub> yaha-yi--ga ]  
**pro<sub>i</sub>** 3/3.UN-taste-IND **3.REFL<sub>i</sub>**-mouth<sub>j</sub> 3.hurt-IND-DS-NM.ACC  
 ‘He<sub>i</sub> tasted it even though his<sub>i</sub> mouth<sub>j</sub> hurt.’ Washo Archive

### 3.2 Proposal

With the behaviors of switch reference as well as our structural assumptions laid out, we now turn to our analysis of switch reference as index agreement. The core of the proposal is that embedded C agrees with the subject of the clause that it’s contained in as well as the subject in the superordinate clause. The SS and DS markers are then the realization of this embedded C, whose spellout may be sensitive to multiple features. Crucially, what the probe agrees for is the value of the referential *index* features on these subjects, which drives the grammatical reference tracking effect. Thus, the claim is that switch reference is a purely morphosyntactic phenomenon, just like agreement generally is: the index values have semantic import on the arguments that control switch reference, but not on the switch-reference morpheme itself. In what follows, we call this index feature [ID], whose value is a natural number; for more on the proposal that index values may enter the derivation as features that participate in agreement, see i.a. Rezac 2004, Hicks 2009, Kratzer 2009, Kennedy 2014, Grosz

<sup>14</sup> The nominalized clause in this example takes on the meaning of a concessive clause, which is uncommon but indeed attested. The vowel [a] in the nominalizer is potentially a point of speaker variation.

2015, Deal 2017b, Hanink and Grove 2017. Our proposal of index agreement has both a syntactic and postsyntactic component, which we discuss in turn.

### 3.2.1 Syntax

Returning to the core properties of switch reference in Washo, we now show how an analysis invoking index agreement captures these essential characteristics. The first behavior to account for is that switch reference operates only across subordinate clause boundaries.<sup>15</sup> We argue that this generalization falls out from the fact that switch reference is the result of Agree (in the sense of Chomsky 2000, 2001). In particular, we propose that embedded C undergoes Multiple Agree (Hiraiwa 2001; see also Zeijlstra 2004, Merchant 2006, Nevins 2007, 2011, Wurmbrand 2014, Deal 2015, and for switch reference in particular, Arregi and Hanink 2018 and Clem 2020). While the direction of probing for Hiraiwa (2001) is consistently *downward*, we propose below that probing can occur *upward* as well, in a bidirectional fashion.

In our system, agreement for the [ID] feature on the *embedded* subject is an instance of Downward Agree on a par with the type of complementizer agreement that is well known from e.g., certain varieties of West Germanic. This type of complementizer agreement is exemplified through Katwijk Dutch in (21), in which the complementizer covaries with the number specification on the embedded subject.

- (21) *Complementizer agreement for  $\phi$ -features in Katwijk Dutch*
- a. ... **dat** ik zuinig leef.  
     **that I** economical live.SG  
     ‘... that I live economically.’ van Koppen 2005:32
- b. ... **datt-e** we gewoon lev-e.  
     **that-PL** we normal live-PL  
     ‘... that we live normally.’ van Koppen 2005:32

This agreement is represented schematically in (22), in which C probes downward for the valued  $\phi$ -features on the embedded subject:

- (22) *Downward complementizer agreement*

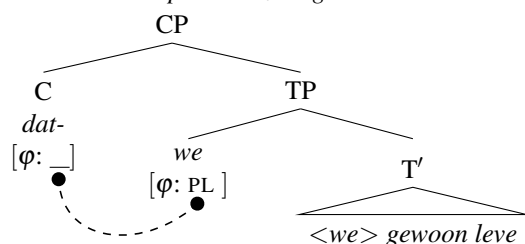

On the other hand, we argue that agreement for the [ID] feature on the *superordinate* subject is an instance of Upward Agree (i.a. Adger 2003, Zeijlstra 2004, Baker 2008,

<sup>15</sup> Crucial to our analysis is the assumption that CP is the only phase boundary in Washo, to the exclusion of vP, PP, and DP. We offer more detail on this matter in Section 3.2.3, pp. 21–22.

Bjorkman 2011, Merchant 2011, Wurmbrand 2012, Bjorkman and Zeijlstra 2019), which resembles complementizer agreement in certain Bantu languages. In the examples below from Lubukusu, the complementizer agrees with the noun class of the superordinate subject, rather than with the embedded subject:

(23) *Complementizer agreement for  $\varphi$ -features in Lubukusu*

- a. **Baba**-ndu ba-bol-el-a Alfredi  
 NC2-people NC2.SBJ-said-AP-FV NC1.Alfred  
 [ **ba-li** a-kha-khil-e ]  
 [ NC2-**that** NC1.SBJ-FUT-conquer ]  
 ‘The people told Alfred that he will win.’ Diercks 2013:358
- b. Alfredi ka-bol-el-a baba-ndu  
 NC1.Alfred NC1.SBJ-said-AP-FV NC2-people  
 [ **a-li** ba-kha-khil-e ]  
 [ NC1-**that** NC1.SBJ-FUT-conquer ]  
 ‘Alfred told the people that they will win.’ Diercks 2013:358

Agreement of this kind can be captured by upward probing by C for the  $\varphi$ -features on the matrix subject as in (24), in which the former probes upward for the valued  $\varphi$ -features on the latter:

(24) *Upward complementizer agreement*

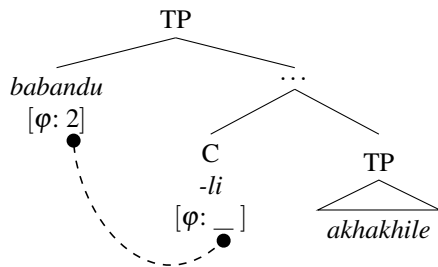

We note briefly that proposals for this type of agreement (Diercks 2013, Carstens 2016, Diercks et al. 2017) are not cast in terms of Upward Agree. Instead, these authors argue that all instances of Agree are either downward or instead result from a local Spec-head configuration. The various alternatives to direct agreement between C and the superordinate subject proposed in these works might work for complementizer agreement Bantu (it’s not our task to argue that here), but they do not extend to switch reference in Washo; we draw the parallel with Bantu here to point out the surface similarity. We return to discuss these alternatives in more depth in Section 5.

Given the existence of both types of agreement patterns, we propose that switch reference can be conceptualized as Multiple Agree implementing both types of complementizer agreement in a single derivation: embedded C probes *downward* for the [ID] feature on the embedded subject, and then *upward* for the same feature on the superordinate subject. To this effect, we adopt the following conditions for Agree (see Bidirectional Agree in Merchant 2006:2):

(25) *Conditions for Agree*

$X$  enters an Agree relation with  $Y$  iff:

- a.  $X$  bears a feature  $F$  with value  $V$  and  $Y$  bears a matching unvalued feature  $F'$ , and
- b.  $X$  c-commands  $Y$  or  $Y$  c-commands  $X$ .

To capture the ability of C to probe more than once, we assume that probes are specified for whether or not they may search multiple times, i.e., this behavior is a probe-specific parameter, as proposed in Hiraiwa 2001. In particular, following a suggestion in Harbour 2011:568, we adopt the idea that, for such probes, each iteration of probing for a particular feature produces an additional unvalued inflectional feature  $F'$ , with the desired effect that multiple values of the same feature may be copied back onto the probe even after the initial  $F'$  is satisfied. Rather than place an undesirable limitation on the number of times that C may probe, we further adopt the assumption that agreement may fail in the sense of Preminger 2014: C will continue to probe for suitable goals until the next C boundary is merged (see the discussion around (26) below). This behavior echoes the notion of *insatiable* probing proposed in Clem 2019 and Deal 2020 (see also Zeijlstra 2004, Merchant 2006).

Returning to restrictions on Agree, we now turn to the second characteristic of switch reference that must be captured: locality constraints. As shown in examples such as (17), repeated below, switch reference may not track subjects in a clause separated by an additional CP boundary:

- (26) [[ **súku?**<sub>*i*</sub> baŋáya ʔ-éʔ-i-š-ge ]<sub>*i*</sub> ]<sub>*i*</sub>  
 [[ **dog**<sub>*i*</sub> outside 3-be-IND-DS-NM.ACC ]<sub>*i*</sub> ]<sub>*i*</sub>  
**daʔmóʔmo?**<sub>*j*</sub> bóŋi-yi-š-gi ]<sub>*i*</sub> p'á:š-ug-i  
**woman**<sub>*j*</sub> 3/3.call-IND-DS-NM.NOM ]<sub>*i*</sub> 3.enter-hither-IND  
 'The dog<sub>*i*</sub> who was outside who the woman<sub>*j*</sub> called came in.'

This follows from our analysis in that index agreement is subject to the same locality constraints found in other types of agreement by C (and other heads), resulting in clause-boundedness. When probing in either direction (downward or upward), C can't probe past an additional clause boundary, that is, the edge of the embedded CP phase may access both the subordinate and superordinate subjects, but may not cross another CP phase-boundary (we further discuss the relevance of phases in Section 3.2.3).

Finally, the third characteristic of switch reference is its sensitivity to the index values of subjects only, in that it ignores all other arguments. To account for this behavior, we propose that the C probe is a *selective* one (Bhatt 2005, Baker 2008, Bobaljik 2008), probing only for nominative DPs (see also Preminger 2014 and Deal 2017a). Washo has an accusative case system, evidence for which is visible in pronouns and clausal nominalizers, as shown in Section 2.

In light of this proposal, a reviewer raises the question of how switch reference interacts with non-nominative subjects, e.g., experiencer datives – on our analysis, the embedded C probe should not be able to track such subjects, as it may only

agree with nominative DPs. As far as we are aware, Washo lacks such subjects.<sup>16</sup> For example, one place we might find such misalignment is with the subjects of psych verbs. However, agreement morphology reveals that no case misalignment obtains with these verbs.<sup>17</sup> This can be seen by the agreement prefixes in (27) with the verbs *like* and *scare*, respectively. In (27a), the experiencer *I* is nominative, and triggers subject agreement. In (27b) moreover, the experiencer *you* is a true object, while *I* is an agent that co-occurs with the causative suffix *-ha* (rather than e.g., a stimulus of a scaring event in which *you* is an experiencer, in which case the prefix would likewise be 2/1, rather than 1/2).<sup>18</sup>

(27) *Agreement alignment in transitive psych verbs*

- |    |   |               |
|----|---|---------------|
| a. | mi-gaʔlám-i<br>1/2-like-IND<br>'I like you'                 | Washo Archive |
| b. | mi-Lók'aš-ha-yi<br>1/2-be.scared-CAUS-IND<br>'I scared you' | Washo Archive |

To summarize, the syntactic component of switch reference involves multiple probing by C for the [ID] feature on accessible, nominative DPs. Downward probing by C for this feature on the subordinate subject is on par with downward complementizer agreement in West Germanic, while upward probing for [ID] on the superordinate subject has a parallel in upward complementizer agreement in Bantu. The locality behaviors observed in switch reference fall out from the fact that embedded C can't probe past another phase boundary in either direction.

### 3.2.2 Postsyntax

We have proposed that, in the syntax, embedded C probes for the values of the [ID] features on two nominative DPs – the subject of the clause its contained in, as well as the subject of the superordinate clause. This results in the copying of two [ID] features onto C, which are ultimately responsible for the difference in exponence between the SS and DS markers. The following vocabulary entries offer a preview of our morphological analysis:

(28) *Vocabulary entries for C*

- |    |   |    |
|----|---|----|
| a. | $[_C \text{ ID}:i, \text{ ID}:j] \rightarrow \check{s}$ (where $i \neq j$ ) | DS |
| b. | $[_C ] \rightarrow \emptyset$   | SS |

<sup>16</sup> Another reviewer asks about the behavior of switch reference with derived subjects. We are not able to test this, as Washo lacks a passive (Jacobsen 1979) and other relevant constructions such as possessor raising.

<sup>17</sup> A reviewer correctly points out that we should be able to test for case-marking on experiencers with pronouns and clausal nominalizations in subject position, as they overtly distinguish between nominative and non-nominative. Unfortunately, we do not have any data of this kind at present.

<sup>18</sup> The preceding argument relies on the assumption that only nominative nominals trigger subject agreement in Washo.

In a nutshell, our proposal is that the DS marker in Washo is overtly realized as *-š* (in contrast to the null SS marker) because it is the realization of *feature conflict*. That is, this suffix is inserted in the morphology when the two index values copied onto C differ from one another, while the null suffix is the elsewhere realization of C.

The notion of feature conflict here builds on Harbour's (2007, 2011) analysis of inverse marking in Kiowa. Harbour argues that many Kiowa nouns have lexically specified number (the language has singular, dual, and plural numbers). Inverse suffixal morphology appears on the noun when these *lexically*-specified features are in conflict with *semantically*-specified features. If no conflict arises, number is unmarked. The following table illustrates three noun classes (out of a total of nine):

(29) *Number-dependent noun marking in Kiowa (Harbour 2011:564)*

Noun	Singular	Dual	Plural	
'fish'	óópíí	óópíí	óópíí- <b>dš</b>	<i>Inherently nonplural</i>
'tomato'	k!ḡḡ- <b>dš</b>	k!ḡn	k!ḡḡ- <b>dš</b>	<i>Inherently dual</i>
'stick'	áá- <b>dš</b>	áá	áá	<i>Inherently nonsingular</i>

Inverse-marked nominals further trigger inverse-specific verbal agreement. Take *áá* 'stick' for example, which is inherently nonsingular:

- (30) a. *Áá-dš e-dóó.*  
stick-INV 3INV-be  
'It's a stick.' Harbour 2011:564
- b. *Áá e-dóó.*  
stick 3DU-be  
'It's two sticks.' Harbour 2011:564
- c. *Áá gya-dóó.*  
stick 3PL-be  
'It's some sticks.' Harbour 2011:564

In (30a), inverse morphology appears on the verb in addition to the noun, which is semantically singular. No inverse morphology appears on the verb in the dual (30b) or the plural (30c) however, as no conflict arises between the lexical and semantic number specifications.

According to Harbour, Kiowa nominals contain two functional layers: a DP immediately dominating NumP, which in turn dominates a projection containing the noun (represented below as NP). The noun is lexically specified for its inherent number, while semantic number is housed in Num. Nominal inflection is the realization of D, which undergoes Multiple Agree for the number features in both the noun and Num. The verb then agrees with D:

(31) *Multiple Agree with NP (inherent number) and Num (semantic number) in Kiowa*

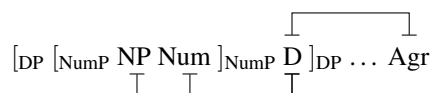

Number features are copied from both NP and Num, which can result in feature conflict:<sup>19</sup>

(32) *Multiple Agree when NP is inherently nonsingular*

a. *No conflict in dual/plural*

NP	Num	Agree →	D, verbal agreement
[−singular]	[−singular]		[−singular, −singular] (=[−singular])

b. *Conflict in singular*

NP	Num	Agree →	D, verbal agreement
[−singular]	[+singular]		[−singular, +singular]

For this particular noun class, the number feature has the same specification in NP and Num when the latter is nonsingular. As a result of Multiple Agree, no feature conflict arises in D (and indirectly, in verbal agreement): the negative value for the feature is copied twice, resulting in [−singular, −singular] (because feature complexes are assumed to be sets, this is equivalent to [−singular]). However, when Num is singular, Multiple Agree results in a conflicting feature specification, namely, [−singular, +singular]. In other noun classes, the conflicting specification arises with other features, that is, [−augmented, +augmented] and [−group, +group], or a combination of these. All of them trigger identical inverse morphology.

Harbour argues that this feature conflict is syntactically well-formed, but is exploited by the morphology to result in inverse morphology, given vocabulary entries of the following form, in which INV stands for various exponents in D and verbal agreement:

(33) *Vocabulary entries in the inverse (adapted from Harbour 2011:569)*

[−*F*, +*F*] → INV (for any feature *F*)

An important aspect of this vocabulary entry is that it's not specific to any particular number feature, hence the use of the variable *F*. When no such feature conflict is present, D is null, and verbal agreement is realized by noninverse singular, dual, or plural exponents.

The crucial idea behind Harbour's proposal is that feature conflict is in principle permissible in the syntax, but is represented by the morphology at Vocabulary Insertion. In order to implement this idea, the use of variables in vocabulary entries becomes necessary, which has precedents in Noyer 1992:159–160 and Alexiadou and Müller 2008:122–124.<sup>20</sup> We adopt this idea in our proposed vocabulary entries for switch-reference morphology.

Returning to Washo, we build on Harbour and propose that the different-subject suffix in Washo is also the realization of feature conflict of index values on C. With

<sup>19</sup> For ease of exposition, the representations below are simplified, in that we only include the number feature [±singular]. Harbour's analysis also includes [±augmented] and [±group], which allows him to account for Kiowa's three-number system and its nine number-based noun classes.

<sup>20</sup> Although Harbour's vocabulary entry for Kiowa uses variables only for the feature attribute, he also makes use of them for feature values in the analysis of inverse number morphology in Jemez (Harbour 2011:576–578).



disjoint subjects, [ID] in C has two values:  $[C \text{ ID}:i, \text{ID}:j]$ . Both feature values are copied during agreement, which is syntactically well-formed, as in inverse number marking in Kiowa. With coreferential subjects, [ID] in C has one value:  $[C \text{ ID}:i, \text{ID}:i] = [C \text{ ID}:i]$ . This featural difference determines the exponence of C at Vocabulary Insertion, as follows:

- (34) *Vocabulary entries for C (repeated from (28))*
- a.  $[C \text{ ID}:i, \text{ID}:j] \rightarrow \check{s}$  (where  $i \neq j$ ) DS
  - b.  $[C] \rightarrow \emptyset$  SS

Adopting the feature conflict approach captures the the apparent inverse morphology of the DS marker as well as the zero exponence of the SS marker. Note the similarity here to Harbour's analysis of Kiowa: we model DS in Washo in terms of feature conflict that comes about in virtue of reference to variables in the vocabulary entries themselves, which are sensitive to conflicting feature values.

### 3.2.3 Putting the pieces together

The following gives the derivation for an example of feature conflict with disjoint subjects (repeated from (10b)), given the analysis developed above:

- (35) a. **Adele<sub>i</sub>** [*pro*<sub>j</sub> *ʔum-bašáʔ-ayt'iʔ-i-š-ge*] *mušéʔeš-i*  
**Adele<sub>i</sub>** [*pro*<sub>j</sub> 2/3-write-PLUP-IND-DS-NM.ACC] 3/3.read-IND  
 'Adele<sub>i</sub>'s reading what you<sub>j</sub> wrote.'  
 b. *The derivation of different subject*

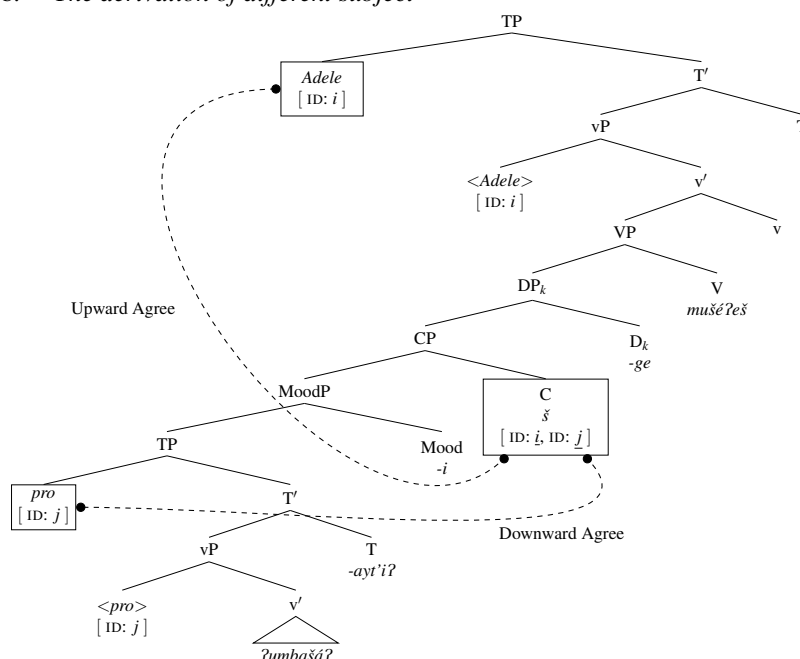

The schematic in (35b) shows that C first probes downward for the [ID] feature on *pro* from its derived position in Spec, TP, and copies its value, *j*, onto C. Embedded C then continues probing upward for the value of [ID] on superordinate *Adele* (after it's been assigned nominative case and has moved to Spec, TP), and copies that value (*i*) as well. C must stop probing once the higher C head is merged. Postsyntactically, the vocabulary entry in (34a) applies due to the presence of two conflicting feature values on C, and as a result C is spelled out with the different-subject exponent *-š*.

Conversely, the following shows an example without feature conflict with coreferent subjects (repeated from (2)):

- (36) a. **Adele<sub>i</sub>** [*pro<sub>i</sub>* daláʔak ʔ-í:gi-yi-∅-ge ] hámpup'ayʔ-é:s-i  
**Adele<sub>i</sub>** [*pro<sub>i</sub>* mountain 3/3-see-IND-SS-NM.ACC ] 3/3.forget-NEG-IND  
 'Adele<sub>i</sub> remembers that she<sub>i</sub> saw the mountain.'

Hanink and Bochnak 2018:67

- b. *The derivation of same subject*

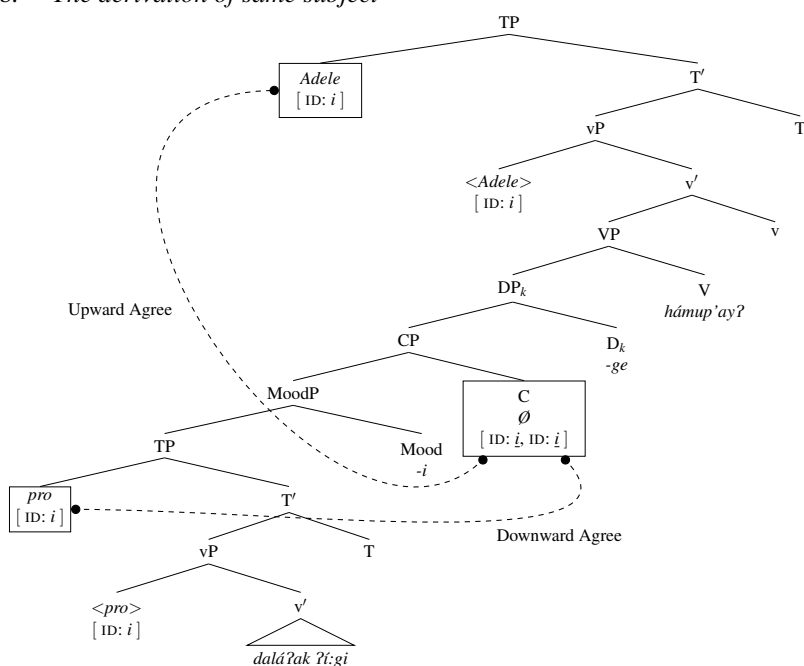

The derivation proceeds here as in (35), but the SS marker is inserted into C according to the elsewhere rule in (34b), due to the absence of conflict in the featural make-up of C.

Note that the examples above also illustrate how the analysis accounts for the fact that switch reference specifically tracks the reference of subjects and not other nominals, including non-subject clausal nominalizations. The C probe is selective and only probes for nominative DPs; the index *k* of the object nominalized clause in both examples is in a position accessible to C by Upward Agree (more specifically,

the D head of the nominal c-commands C), but this nominal is accusative, hence it is ignored by Agree.

Some discussion of the position of the subject becomes relevant here. In the structures in (35) and (36), the subject is located in a derived position in Spec, TP. Given that Washo is a head-final language, the diagnosis of subject position based on standard tests (e.g., McCloskey 1997) is difficult. In any case, as we propose that the C probe is sensitive only to nominative arguments, we assume that agreement with both the matrix and embedded subjects happens after movement to Spec, TP. Related to this, we have to assume here that vP does *not* constitute a phase (den Dikken 2006, Keine 2020), nor does DP (Matushansky 2005, cf. Adger 2003, Svenonius 2004, Lee-Schoenfeld 2008; see Citko 2014 for a recent overview of arguments for and against the phasal status of various functional heads). If vP were a phase, embedded C would be unable to agree with a superordinate nominative subject (as it would not be able to probe past this phase boundary), while if DP were a phase, embedded C would not be able to probe past its nominalization layer.<sup>21</sup> Although this makes DP-internal constituents such as possessors accessible to an external probe, the analysis correctly predicts that switch reference does not track possessors (see (19)), as we assume that these are not nominative in Washo. Finally, we note here that we likewise do not treat PPs as phase heads in Washo (Abels 2003, den Dikken 2010, cf. Kayne 1994, 2004, Bošković 2004, Drummond et al. 2010). This is necessary in particular for cases of clausal nominalizations embedded within a postposition, as in e.g., (14) above, as embedded C must probe past both D *and* P in such cases to find nominative matrix argument.<sup>22</sup>

### 3.3 Interim summary

In this section, we have shown that our analysis captures the core characteristics of switch reference in Washo: i) the subordinate clause boundary requirement; ii) locality constraints; and iii) sensitivity to subjects only. We have offered an analysis involving agreement by C for the [ID] features on nominative DPs that captures all of these behaviors, and which draws close parallels between switch reference and complementizer agreement in West Germanic and Bantu. We have also drawn from independent work on feature conflict and inverse marking in Kiowa in order to motivate the overt realization of the DS marker as -š, where the null SS marker represents the absence of feature conflict on C.

<sup>21</sup> See also Bošković 2015 on the notion of phase *collapsing*, according to which D and C in clausal nominalizations might constitute a single phase barrier following head movement. Under this account, DP could potentially be a phase, but would not add an additional phase boundary in clausal nominalizations.

<sup>22</sup> We do not at this point have any independent evidence for our claim that only CPs are phases in Washo, but we make a note here of the difficulties involved. Specifically, we haven't been able to test the predictions of this claim with respect to extraction, as Washo does not seem to have (overt) A'-movement: relativization does not involve movement (Hanink 2021), and wh-phrases appear to be in situ in questions, based on Emily Hanink's field-work experience with the language.

#### 4 Evidence for Upward Agree from switch reference in clausal nominalizations

In the agreement-based analysis proposed here, switch reference involves an Upward Agree relation between embedded C and the matrix subject. In this section, we argue that this is a necessary component of switch reference in object nominalizations in particular by showing that, as might be expected, these nominalized clauses are structurally lower than the superordinate subject.

Clausal complements of factive (37) and perception (38) verbs must be nominalized in Washo, and like all other clausal nominalizations in the language, display switch reference:<sup>23</sup>

(37) *Switch reference in complements of factive verbs*

a. *Different subject (=I)*

$pro_i$  [ Adele<sub>j</sub> díme? sú:bi?-i-š-ge ] di-hámup'ay?-é:s-i

$pro_i$  [ Adele<sub>j</sub> water 3/3.bring-IND-DS-NM.ACC ] 1/3-forget-NEG-IND

'I<sub>i</sub> remember that Adele<sub>j</sub> brought the water.'

b. *Same subject (=36a)*

Adele<sub>i</sub> [  $pro_i$  dalá?ak ?-í:gi-yi-Ø-ge ] hámup'ay?-é:s-i

Adele<sub>i</sub> [  $pro_i$  mountain 3/3-see-IND-SS-NM.ACC ] 3/3.forget-NEG-IND

'Adele<sub>i</sub> remembers that she<sub>i</sub> saw the mountain.'

Hanink and Bochnak 2018:67

(38) *Switch reference in complements of perception verbs*<sup>24</sup>

a. *Different subject*

$pro_i$  [ sí:su<sub>j</sub> ?-íšim-i-š-ge ] di-dámal-i

$pro_i$  [ bird<sub>j</sub> 3-sing-IND-DS-NM.ACC ] 1/3-hear-IND

'I<sub>i</sub> hear the bird<sub>j</sub> singing./I<sub>i</sub> hear the bird<sub>j</sub> that is singing.'

b. *Same subject*

$pro_i$  [  $pro_i$  l-éšim-i-Ø-ge ] dí:gu di-dámal-i

$pro_i$  [  $pro_i$  1-sing-IND-SS-NM.ACC ] internally 1/3-hear-IND

'I<sub>i</sub> hear that I<sub>i</sub> am singing internally.' (e.g., when humming)

<sup>23</sup> Because of pro-drop, and the general verb-final syntax of the language, it is not always clear whether a given subject should be parsed in a matrix or embedded clause. For instance, both the embedded and matrix subjects in (37b) refer to Adele, but the sentence only contains one overt subject, namely *Adele*. Thus, one of the subjects is *Adele* and the other is pro-dropped, but it is not immediately obvious which is which. Our parse in (37b) places the name in matrix subject position; a decision that we justify based on Condition C, which would be violated under the alternative parse. Condition C effects in Washo and their relevance to switch reference are discussed further below in the text surrounding examples (43)–(44).

<sup>24</sup> As illustrated by the translation in (38a), nominalized complements of perception verbs are often ambiguous between a complement-clause reading and a relative-clause reading, as the latter are internally headed in Washo. As we show below, relative clauses in object position also constitute an argument for Upward Agree, and sentences such as (38a) therefore constitute evidence for the analysis under either the complement-clause or the relative-clause parse.

Since these clauses are in the complement position of the matrix verb as in (39), the fact that they are marked for switch reference is as expected under our Upward Agree account.<sup>25</sup>

(39) *Complement clauses are below the superordinate subject*

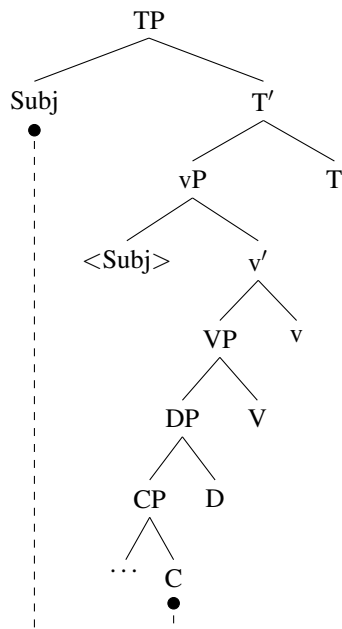

The logic behind this claim is that the embedded clause containing the morpheme that marks switch reference (C) is lower than the superordinate subject, and thus the probe is lower than the goal.

A similar argument can be made on the basis of relative clauses in object position, which are also marked for switch reference, as illustrated in the following examples:<sup>26</sup>

<sup>25</sup> Although switch reference frequently occurs in adverbial clauses crosslinguistically, it is also possible in complement clauses in several languages (McKenzie 2015:431). A well-studied case is Choctaw (Broadwell 2006:268–282).

<sup>26</sup> The dependent mood suffix *-a?* (discussed in Section 2) occasionally surfaces in what appears to be a matrix clause, such as (40b). This tends to occur in narrative contexts, in which the *-a?*-marked clause occurs in a sentence that continues the story, as is the case in (40b). The preceding sentence in this text is *A bear was about to go gathering food*, and it is this bear that the subject of the superordinate sentence in (40b) refers to; (40b) is then followed immediately by a direct quote beginning with *I will go and then ...*, whose subject is also coreferential with the bear. Such uses of the dependent marker in apparent matrix clauses are therefore plausibly analyzed in terms of subordination with respect to the preceding sentence, an instance of something like clause-chaining. Note also that the suffix surfaces as *-ya* in (40b) due to a regular process of y-epenthesis between vowels (Jacobsen 1964:260–265).

(40) *Switch reference in internally headed relative clauses in object position*a. *Different subject*

[ daʔmóʔmoʔ<sub>j</sub> gó:beʔ ʔ-ímeʔ-i-š-ge ]  
 [ woman<sub>j</sub> coffee 3/3-drink-IND-DS-NM.ACC ]

lé:<sub>i</sub>-saʔ 1-émeʔ-gaʔlám-i  
 1.PRO<sub>i</sub>-also 1/3-drink-want-IND

‘I<sub>i</sub> also want to drink the coffee that the woman<sub>j</sub> is drinking.’

b. *Same subject*

pro<sub>i</sub> [ pro<sub>i</sub> git-ŋaʔmíʔmíŋ bóŋi-yi-∅-ge ]  
 pro<sub>i</sub> [ pro<sub>i</sub> 3-child.R 3/3.call-IND-SS-NM.ACC ]

wehigí:git-ha-yaʔ-∅  
 3/3.instruct-CAUS-DEP-SS

‘She<sub>i</sub> instructed her children who she<sub>i</sub> called.’ Bear and Deer Story

Recall that, as discussed in Section 2, relative clauses are always internally headed and nominalized in Washo, and do not involve (covert) A'-movement (Hanink 2021). Furthermore, their surface morphology is the same as found in all clausal nominalizations, i.e., they occur with a final nominalizing suffix (accusative *-ge* in the examples above). With these characteristics in mind, we treat them the same as other nominalized embedded clauses. As in other cases of switch reference, the embedded switch reference marker in the above examples tracks the reference of both the superordinate and embedded subjects (independently of whether the embedded subject is the internal relative-clause head or not): different subject *-š* in (40a), and same subject *-∅* in (40b). Since these nominalizations are complements of V, they provide an additional argument for Upward Agree.

An important assumption in our argument above is that these object nominalizations are indeed complements of verbs, and are not base-generated in some higher position. We take the remainder of this subsection to justify this assumption. The first relevant set of facts has to do with word order. Embedded clauses in Washo tend to be peripheral within the superordinate clause. Although Washo is a pro-drop language, subjects can be overt, and, like other constituents, are often preceded by embedded clauses (Jacobsen 1998), even when the latter are direct objects. For instance, the matrix pronominal subject *lé:* ‘I’ in (40a) follows the relative clause that is interpreted as the direct object. This might be taken as evidence that embedded clauses are in a high position above subjects. If so, their syntax might be incompatible with an Upward-Agree account, contrary to our conclusion above. However, the peripheral position of embedded clauses is not a requirement, only a strong tendency. In particular, it is grammatical for an object clause to either precede or follow the matrix subject. Consider the following minimal pair ((41b) repeated from (35)):

(41) *Variable position of object relative clauses*

- a. [ ʔum-bašáʔ-ayt'iʔ-i-š-ge ] Adele mušéʔeš-i  
 [ 2/3-write-PLUP-IND-DS-NM.ACC ] Adele 3/3.read-IND  
 ‘Adele’s reading what you wrote.’

- b. Adele [  $\text{?um-bašá?-ayt'i?-i-š-ge}$  ]  $\text{mušé?eš-i}$   
 Adele [  $\text{2/3-write-PLUP-IND-DS-NM.ACC}$  ]  $\text{3/3.read-IND}$   
 ‘Adele’s reading what you wrote.’

The relative clause in object position can either precede (41a) or follow (41b) the matrix subject. This variation in word order is also observed with respect to other object nominalized clauses, such as the complements of factive verbs:

(42) *Variable position of factive clauses*

- a. [ Eddy  $\text{gúdiŋa da-ŋám-he:š bugayáy?-i-š-ge}$  ]  
 [ Eddy who 3-son-Q 3.talk-IND-DS-NM.ACC ]  
 Adele  $\text{?-ášaš-i}$   
 Adele 3-not.know-IND  
 ‘Adele doesn’t know whose son Eddy’s talking to.’
- b. Adele [ Eddy  $\text{gúdiŋa-he:š ?-í:gi-yi-š-ge}$  ]  
 Adele [ Eddy who-Q 3/3-see-IND-DS-NM.ACC ]  
 $\text{?-ášaš-é:s-i}$   
 3-not.know-NEG-IND  
 ‘Adele knows who Eddy saw.’

We take these possible clause positions to mean that object nominalized clauses (including relative clauses) are generated as complements of V, but can dislocate to a position above subjects. Crucially, the embedded clause has the exact same switch-reference marking under both orders, as expected by our Upward-Agree account. The Agree relation between the embedded switch reference morpheme and the matrix subject is established from the base position of the embedded clause, and therefore must be upward. In examples such as (41a) and (42a), subsequent dislocation of the embedded clause results in its surface order preceding the matrix subject.

Furthermore, Condition C effects provide converging evidence that object nominalized clauses are generated below subjects, though we note that research into Condition C in Washo is very preliminary (our comments below are the first ever explicit discussion of these issues in the literature). Given this, our argument below is somewhat tentative, and final confirmation awaits further research. Nevertheless, we take the data below as promising initial evidence for our claims about the structural position of object nominalizations in Washo.

Our point here follows Clem (2020), who identifies tests for the base position of adjuncts in Amahuaca with respect to possible reconstruction effects. The logic is that, if the embedded clause were in fact base-generated lower than the subject, then we expect possible reconstruction leading to Condition C violations in case an R-expression in the embedded clause is coreferential with a pronominal subject in the matrix clause. This prediction is born out (43). In this example, the embedded object *Adele* is coreferent with the matrix *pro* subject.

- (43)  $*pro_i$  [  $pro_j$  Adele<sub>i</sub>  $\text{ga?lám-i-š-ge}$  ]  $\text{?-ášaš-é:s-i}$   
 $pro_i$  [  $pro_j$  Adele<sub>i</sub>  $\text{3/3.like-IND-DS-NM.ACC}$  ]  $\text{3/3-not.know-NEG-IND}$   
 Intended: ‘She<sub>i</sub> knows he<sub>j</sub> likes Adele<sub>i</sub>.’

This behavior stands in contrast to, for instance, (44). In this case, *Adele* is the matrix clause subject and corefers with an embedded *pro* object, so that Condition C is not violated.

- (44) [ t'ɛ:liw<sub>j</sub> *pro*<sub>i</sub> ga-gaʔlám-i-š-ge ]  
 [ man<sub>j</sub> *pro*<sub>i</sub> 3/3UN<sub>j</sub>-like-IND-DS-NM.ACC ]  
 Adele<sub>j</sub> ʔ-ášaš-é:s-i  
 Adele<sub>i</sub> 3/3-not.know-NEG-IND  
 'Adele<sub>i</sub> knows the man<sub>j</sub> likes her<sub>i</sub>.'

Importantly here, agreement inflection in the embedded verbs show that *Adele* is the embedded object in (43), but the matrix subject in (44), as is required by our explanation of the grammaticality contrast based on Condition C. That is, agreement inflection shows that there is no parse for (43) in which *Adele* is the subject of the matrix sentence (followed by the embedded clause with pro-dropped subject and object), and no parse for (44) in which *Adele* is the object of the embedded clause (extraposed to the right of the verb). Relevant here is that Washo has two sets of 3-on-3 agreement prefixes, which are conditioned by the overtness of the object. For example, the agreement prefix on the embedded verb in (43) (null, with phonologically conditioned variant ʔ-), is used only when the object is overt, as in the following:

- (45) 3/3 prefix with overt object
- a. daʔmóʔmoʔ ʔitwáʔ yášu-yi  
 woman clothes 3/3.wash-IND  
 'The woman is washing clothes.' Jacobsen 1979:155
- b. gí: pélew ʔ-íʔiw-i (=15a)  
 3.PRO.NOM jackrabbit 3/3-eat-IND  
 'He's eating the jackrabbit.' Jacobsen 1979:151

In contrast, the prefix on the embedded verb in (44) (*ga-*, with phonologically conditioned variant *k'-*) is a special verbal agreement morpheme called *unexpressed object* marking in Jacobsen 1964:462, which is only used when the object is dropped, as in (46).<sup>27</sup>

- (46) 3/3 prefix with dropped object
- a. ga-dámal-i  
 3/3UN-hear-IND  
 'She hears it.' Jacobsen 1996:16
- b. gí: k'-íʔiw-i  
 3.PRO.NOM 3/3UN-eat-IND  
 'He's eating it.' Jacobsen 1979:151

What the agreement morphology on the embedded verbs in (43) and (44) shows is then twofold. On the one hand, in (43), *Adele* must be the object of the *embedded* clause, as no unexpressed-object agreement prefix occurs in the embedded verb. In

<sup>27</sup> Object drop has an effect on the agreement prefix only when the subject is third person. See Douros 2019 for a more complete description, as well as an analysis.



(44) on the other hand, *Adele* must be the subject of the *matrix* clause: it cannot be the object of the embedded verb, which must be covert, as diagnosed by the presence of the unexpressed-object agreement prefix on this verb. Condition C therefore explains the grammaticality distinction between these examples; (43) is ungrammatical because *Adele* is c-commanded by a coreferential pronoun, and (44) is not because the name is not c-commanded by a coreferential pronoun.

In sum, word order facts and Condition C effects provide evidence that object nominalized clauses are generated as complements of V, which strengthens our claim that the switch reference relation between C and the superordinate subject in these clauses is mediated by Upward Agree.

## 5 Alternative analyses

In this section, we argue against alternative accounts of switch reference. These alternative analyses, which were developed for languages other than Washo, include some that are based on agreement but only allow downward or spec-head probing (Clem 2020, McKenzie 2012; we also consider a hypothetical account based on Diercks's (2013) Indirect Agree). Some of the arguments against these accounts are based on the internal structure of nominalizations. These arguments also apply to the coordination-based account in Keine 2013, which we discuss at the end of the section.

Before continuing on with this section, we note that an Agree-based analysis of switch reference in Panoan, sharing some similarities with ours, is developed in Baker and Camargo Souza 2020. In particular, these authors likewise adopt Upward Agree to account for the relationship between embedded C and the superordinate subject, though, unlike us, they make use of the distinction between Agree-Link and Agree-Copy (Arregi and Nevins 2012) rather than appealing to index agreement directly. This leads in turn to a rather different view of what conditions the exponence of SR-morphemes (cf. our appeal to feature conflict). Because our analyses are similar enough in spirit, we do not find it fruitful to argue against their analysis here. We also note that while Baker and Camargo Souza 2020 do not address overlapping reference (see Section 7), this issue is taken up in detail in Camargo Souza 2020.

### 5.1 Accounting for the relation with the superordinate subject in an Agree-based analysis

As described in the previous section, our analysis is based on the hypothesis that the switch-reference morpheme in embedded C establishes a relation with both the subordinate and superordinate subjects through Agree. While the relation with the embedded subject is Downward Agree (i.e., C c-commands the embedded subject), the Agree relation with the superordinate subject is upward, that is, one in which the probe in C is c-commanded by the goal:

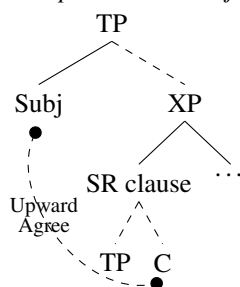
(47) *SR-superordinate subject relation as Upward Agree*

Crucially, the embedded clause is lower than the superordinate subject. In her analysis of switch reference in Amahuaca however, Clem (2020) explores a different possibility, namely that the Agree relation with the superordinate subject is downward. This is made possible by three additional hypotheses. First, the embedded clause hosting switch reference is higher than the matrix subject. Second, the embedded clause is CP, that is, the maximal projection of the head hosting the switch-reference probe. Third, the search domain of the downward probe in C is expanded to include the c-command domain of its maximal projection CP, by Cyclic Agree (Béjar and Rezac 2009). In effect, probing of the matrix subject is done downward by CP instead of C.<sup>28</sup>

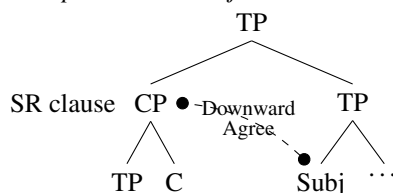
(48) *SR-superordinate subject relation as Downward Agree (Clem 2020)*

Despite the similarity of the analyses, there is at least one important difference that is empirically testable:<sup>29</sup> Under Upward Agree (47), the superordinate subject must be higher than the lower clause, but this relation is reversed in the Downward Agree account (48). The evidence from word order and Condition C presented in the previous section shows that the embedded clause is indeed lower than the superordinate subject in Washo, and therefore constitutes evidence against a Downward Agree account of switch reference, at least for this type of embedded clause. As shown in section 4, Washo object nominalizations can either precede or follow the superordinate subject. In the object-subject order, one might account for switch reference in

<sup>28</sup> In Amahuaca, switch reference tracks objects in addition to subjects. In terms of an agreement-based account, this means that the probe is not restricted to goals that are nominative. We abstract away from these details in the current discussion.

<sup>29</sup> Another difference, discussed in the next subsection, is that the Downward Agree account relies on the switch reference morpheme being hosted in the highest head in the embedded clause, but this is not the case for the Upward Agree account.

terms of Downward Agree, as the object nominalization is higher than the subject after movement. However, the account would then fail on the subject-object order.<sup>30</sup>

What the two analyses discussed so far have in common is that the Agree relation with the matrix subject (whether Upward or Downward) is not constrained by strict locality conditions beyond those required for Agree. This is in contrast with the proposal in McKenzie 2012, to which we now turn, which imposes a much stricter locality condition. In McKenzie’s agreement-based analysis of switch reference in Kiowa, the relation between the switch-reference morpheme and the embedded subject is mediated by Agree, but this is not the case with respect to the superordinate subject. Rather, the embedded clause hosting the switch reference morpheme is interpreted as a one-place predicate (type  $\langle e, \langle s, t \rangle \rangle$ ) whose argument is the superordinate subject. Because of this predication relation, the superordinate subject binds an index in the embedded switch-reference morpheme, whose denotation imposes (non)identity conditions between the referents assigned by the assignment function to this index as well as the index of the embedded subject (which the switch reference morpheme inherits by Agree; see McKenzie 2012:190–196 for details). In effect, this entails that the embedded clause must be the sister of some matrix constituent that is also a one-place predicate; by Predicate Modification (Heim and Kratzer 1998), these two predicates can jointly take the superordinate subject as their argument:

(49) *SR-superordinate subject relation as predication (McKenzie 2012)*

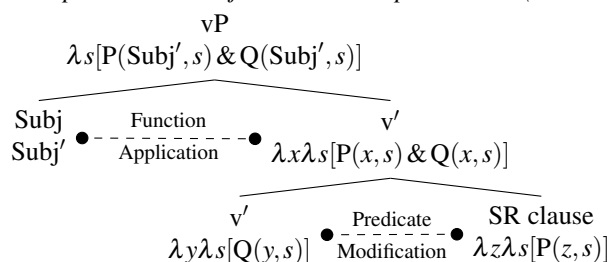

Due to standard locality conditions on semantic composition, the embedded clause must therefore be merged immediately below the superordinate subject, as depicted in (49).

In common with our analysis, this account relies on the the embedded clause being lower than the superordinate subject. However, the problem in extending this account to Washo is that the predication account imposes too strict a locality condition, as the embedded clause must be immediately below the superordinate subject, as shown above. As argued in the previous section, Washo object nominalizations are complements of V:

<sup>30</sup> Even if a parse for this order were possible in which the subject moved to the left of a dislocated object nominalization, there is no evidence to exclude a parse that involves no movement, that is, one in which the object nominalization is in situ and therefore doesn’t c-command the subject or any of movement-generated copies. Furthermore, this addition to the analysis would not help in countering the argument we present in the next subsection.

- (50) *Object nominalizations are too far below the superordinate subject for predication*

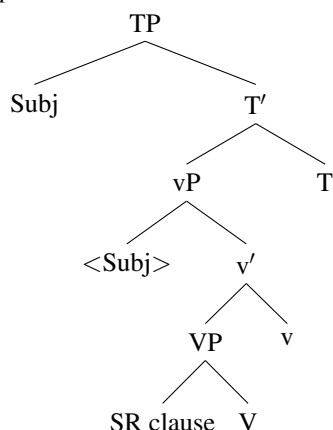

From this low position, the denotation of the embedded clause cannot be predicated of the superordinate subject, as the former is not embedded immediately below the latter. No such problem arises under our Upward Agree account, which does not impose such strict locality conditions on the relation between the embedded clause and the superordinate subject.<sup>31</sup>

## 5.2 A further argument for Upward Agree from the nominalizing layer

An additional problem for previous analyses comes from the presence of the nominalizing layer in clausal nominalizations. As discussed above, Clem's (2020) analysis of switch reference in Amahuaca relies on the ability of an embedded CP to probe downward for the index feature of a superordinate argument (after embedded C has probed for the index feature of the embedded argument). This is due to Cyclic Agree, that is, probing by projections of the head with the probe features. This works well for switch reference in Amahuaca: the switch-reference morpheme is hosted by the highest functional head (C) in the embedded clause, whose maximal projection c-commands material in the superordinate clause. Unlike Washo adjunct clauses (see Section 6), Amahuaca switch-reference morphemes also express the case of the tracked arguments (cf. Baker and Camargo Souza's (2020) analysis of Panoan), but, crucially for this analysis, these features are exponed together with switch reference in a portmanteau, and thus do not represent functional heads that are separate and higher than the C head hosting switch reference.

In this subsection, we demonstrate problems for this type of analysis posed by clausal nominalizations in Washo. Related to the above discussion, the argument is based on the specific functional head (C) that switch reference exponents realize: in

<sup>31</sup> Noting the potential problem that switch reference in complement and relative clauses poses for his account, McKenzie suggests ways in which the account could be extended to cover them, but does not offer any detailed analysis (McKenzie 2012:256–261).

clausal nominalizations, this head is crucially not the highest head, as CP is dominated by a DP projection. We begin by discussing subject nominalizations and then move on to (more problematic) object nominalizations.

Beyond the object nominalizations discussed in Sections 4 and 5.1, clausal nominalizations (including relative clauses) can also be in subject position, in which case the nominalizing suffix is nominative *-gi*. Like other nominalizations, subject clauses are marked for switch reference. Consider first the clausal subjects of predicates such as *good*:

- (51) *Different subject in clausal subjects*  
 [ *pro*<sub>j</sub> m-í:bi-yi-š-gi ]<sub>i</sub> t'-ájaw k'-éʔ-i  
 [ *pro*<sub>j</sub> 2-come-IND-DS-NM.NOM ]<sub>i</sub> NM-be.good 3-be-IND  
 'I'm glad you came.' (lit. 'It's a good thing that you came.')

In this clause type, the embedded subject *you* is the subject of a clause that denotes a proposition. This proposition-denoting clause is itself the subject of the matrix clause, so the two subjects are necessarily disjoint in reference; as a result, only DS marking is possible. Note that nominalizations in subject position can also be relative clauses, and, as expected, also display switch reference from this position:

- (52) *Switch reference in internally headed relative clauses in subject position*  
 a. *Different subject*  
 [ daʔmóʔmoʔ<sub>i</sub> gó:beʔ<sub>j</sub> ʔ-ímeʔ-i-š-gi ]<sub>j</sub> métuʔ-i  
 [ woman<sub>i</sub> coffee<sub>j</sub> 3/3-drink-IND-DS-NM.NOM ]<sub>j</sub> 3.be.cold-IND  
 'The coffee the woman is drinking is cold.'  
 b. *Same subject (= (12))*  
 [ daʔmóʔmoʔ<sub>i</sub> gó:beʔ<sub>j</sub> ʔ-ímeʔ-i-Ø-gi ]<sub>i</sub> la-sú:dim-i  
 [ woman<sub>i</sub> coffee<sub>j</sub> 3/3-drink-IND-SS-NM.NOM ]<sub>i</sub> 3/1-look.at-IND  
 'The woman who is drinking coffee is looking at me.'

The nominalized clause denotes the same individual as its internal head, which can be formed out of any argument in the embedded clause (e.g. the object in (52a) and the subject in (52b)). This allows for both DS (52a) and SS (52b) marking in this type of clause.

What is special about switch reference in subject nominalized clauses is therefore that the embedded switch-reference marker in C agrees with a matrix DP that itself dominates C. We model this by adopting the natural assumption that the index on this DP is shared by its D head, and that it is the index on D that C probes in an Upward Agree relation:

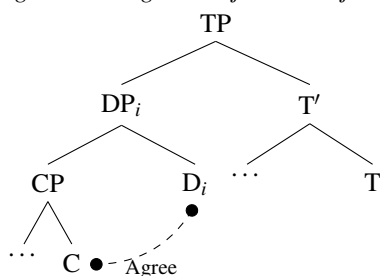
(53) *Agree with higher subject in subject clauses*

An Agree relation between C and the D heading a subject nominalization layer is possible in this case, given that the nominalization is nominative. Note however that it is not possible for object nominalizations, in which D is accusative and therefore not visible to the nominative-specific probe in C, as illustrated in Section 3.2.3. As a consequence, C in object nominalizations probes past the DP layer and agrees with the superordinate (nominative) subject.

Given the structure in (53), other accounts of switch reference can also accommodate sentential subject clauses in Washo. First, under Clem’s (2020) Downward Agree account, D is probed from CP, not C, and thus the relation can be modeled as being downward. Second, McKenzie’s (2012) predication-based account can also be naturally extended to cover this case. Specifically, if we adopt the natural assumption that D is interpreted as a determiner, it can take the predicate-denoting complement CP as its argument, with the result that the DP headed by D, i.e., the matrix subject, in effect binds the index in the embedded switch-reference morpheme.

However, evidence for the height of the complement clause aside (see Section 4), these adaptations of Clem 2020 and McKenzie 2012 immediately run into problems with object nominalizations such as (54).

- (54) [ sí:su ʔ-išim-i-š-ge ] di-dámal-i  
 [ bird 3-sing-IND-DS-NM.ACC ] 1/3-hear-IND  
 ‘I hear the bird singing.’

The problem for McKenzie 2012 is that, just as in subject nominalizations, the predicate denoted by the embedded CP can only apply to its D sister, with the wrong result that the object nominalization itself is tracked by the switch-reference marker, not the superordinate subject. Similarly, under Clem’s (2020) account, the predicted domain for Downward Agree from the maximal projection of the probe (CP) only contains its D sister, and therefore excludes the superordinate subject, contrary to fact.

Importantly, although the nominalizing suffix (-ge in (54)) does express case, unlike Amahuaca switch-reference clauses, this is expressed as a separate morpheme outside the different-subject marker, which must therefore be interpreted as the realization of a higher head (D) within the embedded clause.<sup>32</sup> While DP does c-

<sup>32</sup> Unlike Clem (2020), Baker and Camargo Souza (2020) argue that case in Panoan is realized on a distinct head – as in Washo – that triggers allomorphy on the switch reference morpheme. The case relation differs from Washo however in that it reflects case concord with the case of the matrix subject, rather than the grammatical relation of the nominalization within the matrix clause.

command material in the superordinate clause, CP is too deeply embedded to do so.

Returning to the discussion of the proposed parallel between switch reference and the type of complementizer agreement found in Bantu, note that this argument also offers evidence against extending Carstens’s (2016) analysis of complementizer agreement in Lubukusu to switch reference in Washo. As in Clem’s (2020) analysis, probing in Carstens 2016 is from the probe’s maximal projection, which is higher than the subject after movement. This maximal projection is embedded under DP in Washo, hence probing can’t be downward.

To summarize the arguments presented above: Washo nominalized clauses in object position present two challenges to an approach to switch reference that relies solely on Downward Agree. First, the subordinate clause is too low within the superordinate clause (as the complement of V) for any probe within it to c-command the higher subject. Second, the probe itself (C) is too deeply embedded within the subordinate clause for it or its maximal projection (CP) to c-command into the matrix clause. Although the data they are based on is the same, the two arguments are distinct.

In sum, while subject nominalizations can be accounted for with Downward Agree, a unified analysis of clausal nominalizations is not possible for such an account. Crucially, no such problems arise under the account proposed here: the relation between embedded C and the matrix subject is successfully mediated by Upward Agree, as the superordinate subject (the goal) c-commands embedded C (the probe).

### 5.3 Indirect Agree

We now return to the parallel between switch reference and Bantu complementizer agreement introduced in Section 3.2.1. To account for this type of complementizer agreement in Lubukusu, Diercks (2013) proposes a related notion of *Indirect Agree*, represented in (55) (see also Diercks et al. 2017 on a related but distinct proposal involving anaphoric feature valuation).

(55) *Complementizer agreement as Indirect Agree*

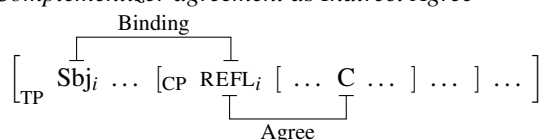

Diercks argues that the apparent upward agreement with the matrix subject is instead entirely local, in that C agrees with a null subject-oriented reflexive pronoun in its specifier, rather than with the superordinate subject directly. This reflexive is bound by the superordinate subject, and thus acquires its  $\phi$ -features. As a consequence, C agrees with that subject, but only indirectly, via the null reflexive in its specifier. Diercks (2013:373–377) accounts for the subject orientation of this posited reflexive based on Safir’s (2004) analysis of subject-oriented reflexives in several languages. Specifically, the null reflexive in the embedded specifier of CP undergoes

covert movement to the superordinate T. In that position, the closest, and therefore only possible, antecedent for the reflexive is the superordinate subject in the specifier of TP.

A possible extension of this type of account to switch reference would be as follows. As in the analysis presented in this article, C would be a probe for index features, and would establish a (downward and direct) Agree relation with the lower subject. However, the relation with the superordinate subject would be indirect: C would agree with a reflexive in its specifier, and the index of this reflexive would match the superordinate subject, as the latter would be the reflexive's antecedent after covert movement of the reflexive to superordinate T. As in our analysis, C would be realized as DS if its indices mismatched, and as SS otherwise. Although no such account of switch reference has been proposed in the literature, we briefly comment here on its prospects.<sup>33</sup>

First, this hypothetical Indirect Agree analysis of switch reference must posit a semantically vacuous reflexive, since switch reference has no effect on meaning.<sup>34</sup> As we discuss in Section 7.2 in reference to other binding-based accounts, we consider this aspect of this type of analysis to be problematic.

Second, agreeing complementizers in Lubukusu are restricted to certain complement clauses (complements to verbs, as well as complements to nominals in object position), but, as documented in this article, switch reference is a property of several different types of embedded clauses in Washo. Working out the details and specific predictions of an Indirect Agree analysis is thus beyond the scope of the present article, but we suspect that it would be highly problematic in the case of switch reference in both adjunct clauses and nominalizations in subject position, as these are likely not licit extraction sites for covert movement of a reflexive.

Finally, we would also like to address the arguments against an Upward Agree account of complementizer agreement in Diercks 2013:392, as they indirectly apply to our analysis of switch reference as well. Diercks claims that two properties of Lubukusu complementizer agreement are problematic for Upward Agree: subject orientation, and the presence of complementizer agreement in DP-internal clauses. Switch reference in Washo shares these two properties, and our Upward Agree-based analysis accounts for both, as discussed in Section 3.

This section has focused thus far on alternative Agree-based accounts to switch reference, both previously-proposed and hypothetical. Before moving on to the discussion of adjuncts in Section 6, we turn in the next section to argue against a different type of account of switch reference that involves coordination, and show that it does not work for clausal nominalizations.

<sup>33</sup> An Indirect Agree account of switch reference in Washo complement clauses is suggested in Clem 2020:footnote 37.

<sup>34</sup> Indeed, this aspect of the analysis of complementizer agreement in Lubukusu is left open in Diercks 2013, which doesn't provide a semantics for the posited null reflexive.



## 5.4 Switch reference is not a marker of coordination height

In a different vein, Keine 2013 presents a syntactic analysis of switch reference in several languages (Seri, Amele, and Kiowa) that does not involve any sort of direct relation between the syntactic host of switch reference morphology and the tracked arguments. Instead, Keine claims that the phenomenon involves coordination of the constituents whose arguments are tracked by the switch-reference marker, and that the marker itself signals the size of the coordinates. Specifically, the marker is the realization of the coordinating particle, whose exponence is sensitive to the category of the coordinates. On the one hand, SS marking is analyzed as coordination of relatively small constituents that do not include the subject (i.e. VP):

(56) *Keine's (2013) proposal for SS marking*

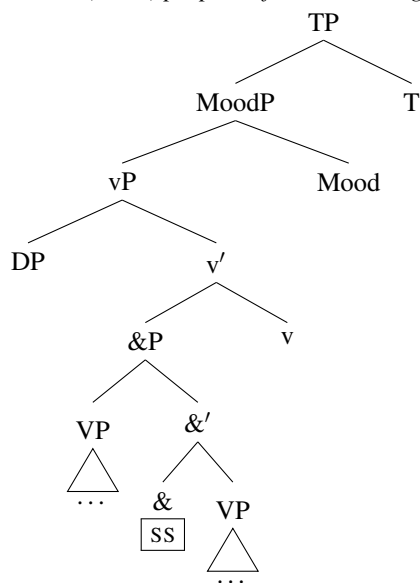

As a result, the two coordinates share a single subject projected above the coordination. This derives the same-subject interpretation not by coreference or binding, as in other analyses, but by actual syntactic sharing of a single subject by both predicates. In contrast, different-subject marking on the other hand involves coordination of larger constituents (vPs):

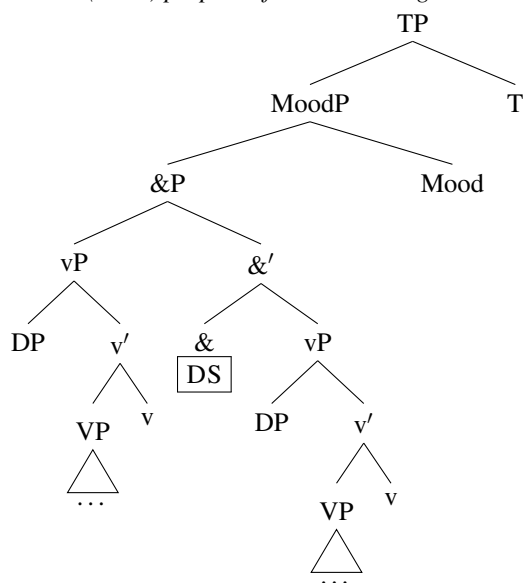
(57) *Keine's (2013) proposal for DS marking*

The two coordinates each include a separate subject, which leads to a disjoint reference effect.<sup>35</sup>

Keine argues that, in the languages that he accounts for in this way (Seri and Amele), the coordinated constituents are indeed small (VP or *v*P). The evidence comes from the fact that in these languages, the exponents of the higher functional heads (Mood and T in (56) and (57)) are impoverished in different ways in the first coordinate. In some cases, these exponents are missing from the first coordinate. Since the heads they expone are above the coordination, they are linearized after the second coordinate (i.e. as suffixes on the verb in the second coordinate, as these languages are head-final). In other cases, the exponents are present as affixes on the verb in the first coordinate, but they have to featurally match the corresponding affixes on the verb in the second coordinate. For these exponents, Keine argues that they are not the exponents of the corresponding functional heads above &P. Rather, the feature content of these functional heads is transmitted to the verbs in both coordinates by agreement that is exponed by these affixes, which accounts for the matching effect.

Switch reference in Washo poses several challenges for this account.<sup>36</sup> First, as discussed in Section 2, Washo clauses with switch reference have a full sentential spine that includes (at least) both TP and MoodP. The heads of these functional projections are realized as suffixes on the switch reference-marked verb, and don't

<sup>35</sup> The exact disjoint-reference effect varies from language to language. See Keine 2013 for details. As may be expected, the analysis is flexible enough to allow for coordination of other categories such as TP or CP, which Keine (2013:807–811) uses in his analysis of noncanonical switch reference in Kiowa. However, his analysis of canonical switch reference only involves coordination of smaller categories (VP and *v*P).

<sup>36</sup> See also Nonato 2014, Weisser 2015, and Clem 2018 for arguments against different aspects of the proposal in Keine 2013.

necessarily featurally match the corresponding inflectional heads on the verb in the other clause. This is furthermore the case in both different-subject and same-subject clauses. For instance, the switch reference clauses in (10a) and (11) contain a future-tense suffix that is not matched by the verb in the other clause. Similarly, the adjunct clause in (7) bears the dependent mood suffix *-aʔ*, mismatched by the independent mood suffix *-i* on the verb in the matrix clause (see also (60a)–(60b) below).

Second, Washo embedded clausal nominalizations cannot plausibly be analyzed in terms of coordination. Consider the following example (repeated from (41a)):

- (58) [ ʔum-bašáʔ-ayt'íʔ-i-š-ge ] Adele mušéʔeš-i  
 [ 2/3-write-PLUP-IND-DS-NM.ACC ] Adele 3/3.read-IND  
 'Adele's reading what you wrote.'

This sentence (and perhaps many others) does have a coordination-like paraphrase in English:

- (59) You wrote something, and Adele is reading it.

Under a coordination analysis, the first clause in (58) would be an initial coordinate instead of an embedded clause. The first problem is that coordination would not be able to explain the fact that the nominalizer (*-ge* in this example) expones the case corresponding to its subordinate position in the superordinate clause. In the example above, this is accusative *-ge*, as expected for a nominalized clause that is the internal argument of the matrix transitive verb. In addition, the paraphrase in English (59) relies on an anaphoric link (in the shape of the pronoun *it*) between the object of *read* and the initial coordinate. This might seem like a plausible analysis of the second clause in (58), as Washo has object drop (discussed in Section 4). However, the verb *mušéʔeš* 'read' in this example bears the null 3-on-3 agreement prefix, used whenever the object is overt (see (45)). If the paraphrase in (59) were correct for Washo (58), we would expect the unexpressed agreement prefix on *mušéʔeš* (see (46)), contrary to fact.

To summarize, a number of properties of switch-reference clauses in Washo lend evidence against a coordination-based analysis, which we take as further support for an agreement-based account. We now move beyond clausal nominalizations and turn our attention to switch-reference marking in adjunct clauses.

## 6 Switch reference in adjuncts

The aim of this section is to provide further evidence for Upward Agree from switch reference in adjunct clauses. The data from adjuncts do not form a central part of our argument, as a range of other proposals are designed to account for constructions of this type and could in principle be extended to Washo (data from clausal nominalizations aside). However, we briefly show below that Upward Agree is required to account for switch reference in adjuncts as well, consistent with our broader claims about Washo.

Switch-reference marking is present in adjunct clauses of different types in Washo. We illustrate these with dependent-marked *-aʔ* clauses (60), which usually have

a simultaneous temporal reading roughly translatable to English as *when* or *while* clauses, or as coordination with *and* (Bochnak and Hanink 2019):

(60) *Switch reference in adjunct clauses*

a. *Different subject*

[ súkuʔ<sub>i</sub> le-gí:t'íʔ-a-š ] *pro*<sub>j</sub> de-gum-suʔúʔuš-leg-i  
 [ dog<sub>i</sub> 1-bite-DEP-DS ] *pro*<sub>j</sub> 1-REFL-dream-REC.PST-IND  
 'I was dreaming while the dog bit me.' Washo Archive

b. *Same subject*

[ mé:hu<sub>i</sub> ʔ-élšim-aʔ-Ø ] *pro*<sub>i</sub> ʔ-émc'i-gaʔlám-é:s-i  
 [ boy<sub>i</sub> 3-sleep-DEP-SS ] *pro*<sub>i</sub> 3-wake.up-want-NEG-IND  
 'The boy is sleeping and he doesn't want to wake up.'  
 (Lit.: 'While the boy's sleeping, he doesn't want to wake up.')

Unlike other clause types discussed in Section 5.2, adjunct *-aʔ* clauses do not have a nominalization layer. They are characterized by the so-called dependent mood suffix *-aʔ*, a realization of Mood (Bochnak 2016, Hanink and Bochnak 2018) as mentioned in Section 2. The highest head in the clause is C, the switch-reference probe in Washo, which thus surfaces as the DS or SS marker ((60a) and (60b), respectively), tracking the reference of the subject of the adjunct clause and the subject of the superordinate clause.

Several previous works offer analyses of switch-reference marking in adjunct clauses. These differ however with respect to the relative position of the switch-reference-bearing adjunct clause and the superordinate subject. Under McKenzie's (2012) predication account of Kiowa, the adjunct clause is lower than the superordinate subject.<sup>37</sup> Baker and Camargo Souza (2020) make the same claim for Shipibo and Yawanawa. As in our analysis, the latter likewise adopt Upward Agree to account for these facts. On the other hand, in Clem's (2020) Cyclic Agree account, the adjunct clause is higher than the subject. Clem claims that switch-reference-marked adjunct clauses are higher than the lowest position of superordinate subjects in Amahuaca, a claim she supports based on word order and Condition C connectivity effects.

Importantly here, evidence from related Condition C effects in Washo adjuncts supports the view that these clauses are base-generated lower than the subject. Condition C effects are crucial here, as word order in sentences with clausal adjuncts alone is not sufficient to ascertain whether the subject belongs in one clause or the other. For example, there are two possible parses for the SS-marked adjunct in (60b). The first potential parse is shown in (61a), in which the overt subject *mé:hu* 'boy' is in the embedded clause, with silent *pro* in the matrix clause. The alternative parse is shown in (61b), in which the adjunct containing a null subject is center-embedded, and the overt subject in fact belongs to the matrix clause.

<sup>37</sup> Kiowa also has switch reference in coordination. McKenzie (2012) argues that in this language switch reference is canonical in adjuncts, but noncanonical in coordination, and we thus restrict our attention to the former type here.

- (61) a. [ mé:hu<sub>i</sub> ʔ-élšim-aʔ-Ø ] *pro*<sub>i</sub> ʔ-émc'i-gaʔlám-é:s-i  
 [ boy<sub>i</sub> 3-sleep-DEP-SS ] *pro*<sub>i</sub> 3-wake.up-want-NEG-IND
- b. mé:hu<sub>i</sub> [ *pro*<sub>i</sub> ʔ-élšim-aʔ-Ø ] ʔ-émc'i-gaʔlám-é:s-i  
 boy<sub>i</sub> [ *pro*<sub>i</sub> 3-sleep-DEP-SS ] 3-wake.up-want-NEG-IND  
 'The boy is sleeping and he doesn't want to wake up.'  
 (Lit.: 'While the boy's sleeping, he doesn't want to wake up.')

In the case of different-subject marking, all examples that we have in which an overt subject is only parsable as a superordinate subject, it follows the adjunct clause, potentially indicating that adjuncts are never center-embedded.

- (62) [ súkuʔ Muʔúš-uwaʔ-a-š ] bú:ši ʔ-élšim-i  
 [ dog 3.run-hence-DEP-DS ] cat 3-sleep-IND  
 'The dog ran and the cat slept.' (= 'While the dog ran, the cat slept.')

However, despite surface word order in DS-marked adjuncts, there is evidence from Condition C that suggests that adjunct clauses are lower than subjects in Washo.<sup>38</sup> Here we return to the arguments from Condition C effects that we made in Section 4, based on Clem 2020. First consider the grammatical example in (63), in which the R-expression *daʔmóʔmoʔ* 'woman' in the matrix clause is coreferential with the covert possessor of the embedded subject *da-gúšuʔ* 'her dog'.

- (63) daʔmóʔmoʔ<sub>i</sub> [ <sub>DP</sub> *pro*<sub>i</sub> g-áŋal ] ʔ-á:daʔé:šib-ášaʔ-i  
 woman [ <sub>DP</sub> *pro*<sub>i</sub> 3.REFL-house ] 3/3-fix.up-PROSP-IND  
 [ [ <sub>DP</sub> *pro*<sub>i</sub> da-gúšuʔ ] ʔ-élšim-a-š ]  
 [ [ <sub>DP</sub> *pro*<sub>i</sub> 3UN-pet ] 3-sleep-DEP-DS ]  
 'The woman<sub>i</sub> is going to clean her house while her<sub>i</sub> dog is sleeping.'

Coreference is possible, as no Condition C violation is expected in this configuration. The specific pattern of possessor agreement in this sentence supports the parse adopted above. The sentence has two nominals marked for possessor agreement: *g-áŋal* 'house' in the matrix clause and *da-gúšuʔ* 'pet' in the embedded clause. Although the possessors of both nominals are interpreted as the woman, they are both covert. First, matrix *g-áŋal* is marked with the reflexive agreement marker *g-*, which is only licensed if its possessor is covert and coreferential with a clause-mate subject (64a) (Jacobsen 1964:423). Second, embedded *da-gúšuʔ* is marked with the phonologically conditioned unexpressed agreement marker *t'/d<sup>e</sup>*- (64b), which is only licensed when the possessor is covert and does not have a clause-mate antecedent (Jacobsen 1964:419).

<sup>38</sup> As noted in Section 4, research into Condition C effects in Washo is very preliminary, which makes our arguments here somewhat tentative.

(64) *Reflexive and unexpressed third person possessor agreement in Washo (Jacobsen 1979:149)*<sup>39</sup>

- a. t'é:liw<sub>i</sub> [DP *pro*<sub>*i*/\**j*</sub> g-áŋjal-a ] ʔ-íp'am-aʔ  
 man<sub>i</sub> [DP *pro*<sub>*i*/\**j*</sub> 3.REFL-house-OBL ] 3-arrive-DEP  
 'The man<sub>i</sub> reached his<sub>*i*/\**j*</sub> (own) house.'
- b. t'é:liw<sub>i</sub> [DP *pro*<sub>*i*/*j*</sub> t'-áŋjal-a ] ʔ-íp'am-aʔ  
 man<sub>i</sub> [DP *pro*<sub>*i*/*j*</sub> 3.UN-house-OBL ] 3-arrive-DEP  
 'The man<sub>i</sub> reached his<sub>*i*/*j*</sub> house.'

As a consequence, *daʔmóʔmoʔ* 'woman' in (63) must be the subject of the matrix clause, as it cannot be the possessor of the other two nominals. This sentence contrasts with the following, in which coreference between the matrix covert subject and the embedded possessor *Adele* is not possible:

- (65) a. \* [ [DP Adele<sub>*i*</sub> ʔ-áŋjal ] l-á:daʔé:šib-a-š ] *pro*<sub>*i*</sub> ʔ-íšim-i  
 [ [DP Adele<sub>*i*</sub> 3-house ] 1/3-fix.up-DEP-DS ] *pro*<sub>*i*</sub> 3-sing-IND  
 Intended: 'While I'm cleaning Adele's<sub>*i*</sub> house she's<sub>*i*</sub> singing.'
- b. \**pro*<sub>*i*</sub> ʔ-íšim-i [ [DP Adele<sub>*i*</sub> ʔ-áŋjal ] l-á:daʔé:šib-a-š ]  
*pro*<sub>*i*</sub> 3-sing-IND [ [DP Adele<sub>*i*</sub> 3-house ] 1/3-fix.up-DEP-DS ]  
 Intended: 'She's<sub>*i*</sub> singing while I'm cleaning Adele's<sub>*i*</sub> house.'

That *Adele* is in the embedded clause is confirmed, again, by possessor agreement. In this case, the embedded possessum *ʔ-áŋjal* 'house' is marked with phonologically conditioned  $\emptyset/ʔ$ -, which is licensed only when the possessor is overt and does not have a clause-mate antecedent, as in (66).

- (66) *Third person agreement for overt possessors in Washo (Jacobsen 1979:149)*  
*pro*<sub>*i*</sub> [DP t'é:liw<sub>*i*/*j*</sub> ʔ-áŋjal-a ] ʔ-íp'am-aʔ  
*pro*<sub>*i*</sub> [DP man<sub>*i*/*j*</sub> 3-house-OBL ] 3-arrive-DEP  
 'He<sub>*i*</sub> reached the man's<sub>*i*/*j*</sub> house.'

Therefore, *Adele* in both examples in (65) must be the possessor of the embedded subject, and coreference with the matrix subject causes a Condition C violation.

In sum, as in the case of complement clauses, evidence from Condition C effects reveals that the base position of *-aʔ* adjuncts is lower than the matrix subject. These data therefore constitute additional evidence for an analysis in which the relation between the switch-reference probe and the superordinate subject is consistently Upward Agree.

## 7 Overlapping reference and alternative analyses

In the previous sections, we have focused largely on Agree-based analyses of switch reference (McKenzie 2012, Arregi and Hanink 2018, Clem 2020, Baker and Carmargo Souza 2020). Moving beyond agreement-based analyses, the aim of the present

<sup>39</sup> Jacobsen's glosses have been adapted slightly for consistency.

section is to rule out possible alternatives that have been proposed to account for switch reference, particularly those based on binding (Finer 1985, Watanabe 2000) and control (Georgi 2012). We show in particular that such accounts face problems from data involving overlapping reference.

Overlapping reference refers to cases in which the referents of the two subjects tracked by switch reference overlap (either because one or both are plural). In the examples below, we focus on the specific case in which the referent of a singular subject is a proper subset of the referent in a plural subject. Languages vary according to the way in which switch reference is marked in such cases (see McKenzie 2015:427 and Roberts 2017:553–558), but overlapping reference in Washo leads to optionality in the form of the switch reference marker.<sup>40</sup> The examples below illustrate this with clausal nominalizations, in the specific case in which the referent of the embedded subject is a proper subset of the referent of the matrix subject.<sup>41</sup>

- (67) a. [ **Adele**<sub>i</sub> ga-sú:bi?-i-š-ge ]  
 [ **Adele**<sub>i</sub> 3/3UN-bring-IND-DS-NM.ACC ]  
 lé-š<sub>i,j</sub> gó:be? l-éme?-i  
 1.PRO-DU<sub>i,j</sub> coffee 1/3-drink-IND  
 ‘We (=Adele and I) are drinking the coffee Adele brought.’
- b. lé-š<sub>i,j</sub> gó:be? l-éme?-i  
 1.PRO-DU<sub>i,j</sub> coffee 1/3-drink-IND  
 [ **Adele**<sub>i</sub> ga-sú:bi?-i-Ø-ge ]  
 [ **Adele**<sub>i</sub> 3/3UN-bring-IND-SS-NM.ACC ]  
 ‘We (=Adele and I) are drinking the coffee Adele brought.’

Both the DS (67a) and SS (79b) markers are available in this context. The following examples illustrate this optionality with temporal adjuncts.<sup>42</sup>

- (68) a. *Embedded Sbj*  $\subset$  *Matrix Sbj*  
 [ **Emily** gé:gel-a?-{š/Ø} ] **Adele ida Emily** wagayáy?-i  
 [ **Emily** 3.sit-{DS, SS} ] **Adele and Emily** 3.talk-IND  
 ‘Adele and Emily are talking while Emily is sitting.’

<sup>40</sup> These facts were noticed at least to some extent by Jacobsen (1967:244) and in more detail by Finer (1984) (material in brackets our own): “The generalization here in Washo appears to be that DS is [obligatorily] present only when the subjects of two hierarchially adjacent clauses are disjoint in reference (refer to sets that have no members in common)” (Finer 1984:88).

<sup>41</sup> A reviewer asks with respect to (67) whether the position of the embedded clause has an effect on whether DS or SS marking is used. To our knowledge, it does not; the different clause orders here are an artifact of elicitation.

In these examples, the accusative-marked nominalizations seem to be appositive headless relative clauses modifying the direct object *gó:be?* ‘coffee’, in a displaced clause-peripheral position (see Section 4 for discussion of the surface position of embedded clauses). This is shown by the fact that the embedded verb has an unexpressed object agreement prefix, which diagnoses that the direct object must be a dropped pronoun, in this case anaphoric (or cataphoric) to *gó:be?* ‘coffee’ (see Section 4 on this agreement prefix). This rules out an externally headed restrictive relative clause account of these examples.

<sup>42</sup> The mood marker *-a?* becomes *-a* before *š*; see footnote 7.

- b. *Matrix Sbj*  $\subset$  *Embedded Sbj*  
 [ **Adele ida Emily** wagayáyʔ-aʔ-**{š,∅}** ] **Emily** bašáʔ-i  
 [ **Adele and emily** 3.talk-DEP-**{DS, SS}** ] **Emily** 3.write-IND  
 ‘Emily is writing while Adele and Emily are talking.’

The examples in (68) additionally show that the direction of the subset relation does not matter in the choice of switch reference morpheme. The same is true in nominalizations, as can be seen in (67) for the embedded  $\subset$  matrix case, and in the following for the reverse:

- (69) a. [ **lé-ši**<sub>*i,j*</sub> lákʔaʔ súkuʔ di-begúweʔ-i-š-ge ] **pro**<sub>*i*</sub> di-gaʔlám-i  
 [ **1.PRO-DU**<sub>*i,j*</sub> one dog 1/3-buy-IND-**DS**-NM.ACC ] **pro**<sub>*i*</sub> 1/3-like-IND  
 ‘I like one dog that we bought.’  
 b. [ **lé-ši**<sub>*i,j*</sub> lákʔaʔ súkuʔ di-begúweʔ-i-**∅**-ge ] **pro**<sub>*i*</sub> di-gaʔlám-i  
 [ **1.PRO-DU**<sub>*i,j*</sub> one dog 1/3-buy-IND-**SS**-NM.ACC ] **pro**<sub>*i*</sub> 1/3-like-IND  
 ‘I like one dog that we bought.’

### 7.1 Reference overlap in an Agree-based account

As stated in Section 3.2, our proposal does not immediately extend to cases of overlapping reference. More specifically, the proposed vocabulary entries deriving switch reference morphology are repeated below in (70).

- (70) *Vocabulary entries for C*  
 a. [ <sub>C</sub> ID:*i*, ID:*j* ]  $\rightarrow$  š (where  $i \neq j$ ) DS  
 b. [ <sub>C</sub> ]  $\rightarrow$  ∅ SS

This set of vocabulary entries incorrectly predicts DS in all cases of overlapping reference, under the assumption that a plural-denoting nominal has a single referential index.

In our view, there are two ways to extend the analysis to account for cases in which the referent of a nominal contains more than one individual. The first is to adopt the proposal that the value of [ID] in plural DPs has one index for each individual in its referent (Sportiche 1985, Rullmann 2003),<sup>43</sup> as well as the assumption that agreeing C in Washo may copy *exactly one index* from [ID] on each nominative DP it agrees with. This predicts optionality the following way. In case the two copied indices happen to match (71), SS -∅ will be inserted:

- (71) *Copy the same index from plural DP as singular DP*  
 [ DP[ID:*i*] ... C[ID:*i*,*i*] ] DP[ID:*i*,*j*]  
 SS

In case the ‘wrong’ (i.e., disjoint) index is copied (72), DS -š will be inserted:

<sup>43</sup> We take this hypothesis about the index of plural nominals to be a good first approximation to capturing their referential properties. Admittedly, the semantics of plural nominals raises complex issues that are well beyond the scope of this article, especially in the case of indefinite and quantified nominals. None of the examples involving reference overlap in this article have indefinite or quantificational subjects.



- (72) *Copy a different index from plural DP as singular DP*  
 [ DP[*ID:i*] ... C[*ID:i,j*] ] DP[*ID:i,j*]

DS

This approach thus accounts for the optionality of DS/SS in a language like Washo.

As noted above, however, there is variation in the choice of morpheme in cases of overlapping reference, as many languages have obligatory DS in overlapping contexts. In order to capture this variation, we could alternatively propose the following parameter:

- (73) *ID-Probe Parameter*  
 Agree copies *all/exactly one* index in the value of [ID] in the Goal.

In a nutshell, while agreement in Washo must copy one index in the Goal, agreement in languages in which DS is obligatory must copy *all* indices. If this is the case, there is no way to derive SS in overlapping contexts, as at least one of the indices copied from the plural nominal is different from the one copied from the singular nominal:

- (74) *Copy all indices from plural DP*  
 [ DP[*ID:i*] ... C[*ID:i,i,j*] ] DP[*ID:i,j*]

DS

There is preliminary evidence that this type of approach makes the correct prediction: At least for languages of North America (as surveyed in McKenzie 2015:427), there is no language that exhibits obligatory SS marking in cases of overlapping reference. That is, the morpheme in such cases can be either optionally DS/SS, or obligatorily DS. The generalization is however more complex. First, obligatory SS languages are unattested in McKenzie's survey, but this may be due to an absence of relevant data. Second, obligatory SS languages are claimed to exist in Papua-New Guinea (Roberts 2017:553–558). We note regarding the second point however, that either the reported paradigms are not exhaustive, or the claim is not supported by negative evidence (e.g. Bruce 1984 for Alambalak, Roberts 1987:292–297 for Amele.) Additionally, person and number are often relevant, suggesting an analysis in which the probe copies features other than [ID], with potentially complex consequences for exponence (see also Valenzuela 2003:429–434 for Shipibo).

A reviewer raises the issue that agreement (e.g., subject agreement) does not usually target arbitrary subsets of features in the way that we have modeled it here. For example, there are languages in which agreement is only for a particular *type* of feature, e.g., number or person, but there is no language we are aware of in which agreement indiscriminately copies any  $\varphi$ -feature from the target, such that, in a random fashion, number or person agreement is expressed. However, it is notable that index features are special in that their set of possible values is infinite, contrasting with their  $\varphi$ -counterparts, whose possible values are instead finite and in fact highly restricted. It seems plausible on this basis that feature copying might be subject to different conditions for index and  $\varphi$ -features.

The second option to extend our proposal to overlapping reference is to propose different entries for Vocabulary Insertion. On this approach, the value of [ID] is a set that contains a different index for every individual in its referent. Agree copies the

index sets from both subjects, and the vocabulary entries do all the work of mapping different types of set-theoretic relations between these sets to exponence. The following are the vocabulary entries for Washo under this account (where  $x$  and  $y$  are variables over sets of indices):

- (75) *Alternative vocabulary entries for C*
- a.  $[C \text{ ID}:x, \text{ ID}:y] \rightarrow \xi$  (where  $x \neq y$ )
  - b.  $[C \text{ ID}:x, \text{ ID}:y] \rightarrow \emptyset$  (where  $x \cap y \neq \emptyset$ )

In cases of overlapping reference, the two sets are distinct, but they also have a non-null intersection (i.e. they overlap), so that either exponent can be inserted in C.

The cross-linguistic predictions here are rather different from those arising from the ID-Probe Parameter. Most notably, entries such as those in (75) do not place any principled restrictions on the obligatoriness vs. optionality of SS marking in overlapping contexts, as the elsewhere option could be specified language-specifically either as in (76b), resulting in obligatory DS, or as in (77b), resulting in obligatory SS (DS and SS below stand for exponents).

- (76) *Obligatory DS*
- a.  $[C \text{ ID}:x, \text{ ID}:y] \rightarrow \text{DS}$  ( $x \neq y$ )
  - b.  $[C ] \rightarrow \text{SS}$
- (77) *Obligatory SS*
- a.  $[C \text{ ID}:x, \text{ ID}:y] \rightarrow \text{SS}$  ( $x \cap y \neq \emptyset$ )
  - b.  $[C ] \rightarrow \text{DS}$

This option therefore faces the possible problem of overgeneration. Any permutation of behaviors in overlapping reference should be allowed, and it is an open empirical question whether any language has obligatory SS-making in overlapping reference contexts. Again here moreover, a reviewer expresses concern about the ability of vocabulary entries to be sensitive to set-theoretic relations beyond identity, such as intersection. We share this concern, but for reasons similar to those described above, we believe that the fact that the value of an index feature can have an infinite cardinality makes this type of proposal plausible.

While we believe the proposals in this subsection are on the right track, they are tentative for two reasons. The first has to do with the empirical facts, simply because this facet of switch reference is not well-studied. The second has to do with the above-raised issues concerning the potential differences between index and  $\phi$ -agreement with respect to the inner workings of Agree or Vocabulary Insertion. We note however that recent work by Nevins and van Urk (2020) extends the analysis developed here to a wide range of variation in the available cross-linguistic data on referential overlap.

## 7.2 Switch reference as binding

In similar accounts upon which our own proposal is based, Finer 1984, 1985 and Watanabe 2000 claim that, while the dependency established with the embedded sub-

ject is agreement, the one with the superordinate subject is binding in the sense of Chomsky 1981 (though, from an  $\bar{A}$ -position, see Aoun 1981; see Enç 1989, Broadwell 1990, 1997, and Nonato 2014 for other binding-based accounts). That is, embedded C enters two dependencies. First, it acquires the referential index of the embedded subject via agreement. Second, C itself is either a reflexive (when surfacing as SS), or a pronoun (when surfacing as DS):

(78) *Switch reference as binding*

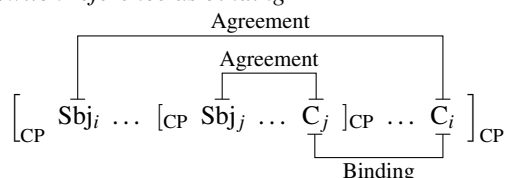

Crucially, Conditions A and B of Binding Theory ensure that SS only surfaces when C is bound by the higher subject, and DS when it is free.

Although this set of proposals captures some of the properties of Washo switch reference, there are several issues for this approach (see also arguments against a binding approach from Amele in Roberts 1988).<sup>44</sup> First, canonical switch reference makes no detectable contribution to meaning (see McKenzie 2012:50–52 for relevant discussion). An Agree-based analysis captures this, under the standard assumption that features in agreement targets (probes) are not interpreted semantically, but a Binding-Theoretic account must stipulate the existence of semantically vacuous reflexives and pronouns (indeed, neither Finer (1985) nor Watanabe (2000) provide a semantics to their posited reflexives and pronouns).

Second, the binding approach makes the prediction that DS and SS marking should have the same distribution as anaphors and pronouns in overlap contexts, which is not borne out. Recall that both DS and SS are possible when the referent of one of the subjects is a subset of the referent of the other (examples repeated from (67)):

- (79) a. [ Adele<sub>i</sub> ga-sú:bi?-i-š-ge ]  
 [ Adele<sub>i</sub> 3/3UN-bring-IND-DS-NM.ACC ]  
 lé-š<sub>i,j</sub> gó:be? l-éme?-i  
 1.PRO-DU<sub>i,j</sub> coffee 1/3-drink-IND  
 ‘We (=Adele and I) are drinking the coffee Adele brought.’
- b. lé-š<sub>i,j</sub> gó:be? l-éme?-i  
 1.PRO-DU<sub>i,j</sub> coffee 1/3-drink-IND  
 [ Adele<sub>i</sub> ga-sú:bi?-i-Ø-ge ]  
 [ Adele<sub>i</sub> 3/3UN-bring-IND-SS-NM.ACC ]  
 ‘We (=Adele and I) are drinking the coffee Adele brought.’

<sup>44</sup> McKenzie (2012:95–96) makes a tentative argument against a binding-based account, based on the wrong prediction that matrix clauses should be uniformly marked as DS, but also notes that there are ways to amend the analysis to avoid this prediction.

Given the parallel posited between DS and pronouns on the one hand, and between SS and reflexives on the other, the binding-theoretic analysis of switch reference predicts that both pronouns and anaphors should be possible in overlap contexts in Washo, contrary to fact. In particular, Rooryck (2006) reports that, in cases of referential overlap, pronouns are possible in a monoclausal context in English and other languages (see also Postal 1966:91, Postal 1969, Chomsky 1973, and Lasnik 1981 for relevant discussion):

(80)  $I_i$  saved us<sub>*i,j*</sub>.

However, reflexives are ruled out:

(81) \* $I_i$  saved ourselves<sub>*i,j*</sub>.

The same judgments hold for Washo. Washo lacks a *self* anaphor, but does have an invariant reflexive prefix *gum-*, shown below in the examples (from the Washo Archive) with first (82a), second (82b), and third (82c) person subjects, respectively.

- (82) a. táʔwi-lu di-**gum**-yá:k'im-i l-á:du-ya ʔida di-yáha-yetiʔ-  
knife-INST 1-REFL-cut-IND 1-hand-OBL and 1-hurt-INCH-IND  
'I cut myself on the hand with a knife, and I began to hurt.'
- b. mi-**gum**-gác'ap-he:š-i  
2-REFL-kick-IND  
'Did you kick yourself?'
- c. daʔmóʔmoʔ **gum**-yá:k'im-i  
woman 3.REFL-cut-IND  
'The woman cut herself.'

Again here, Washo displays the same behavior with respect to overlap in the pronominal domain as does English. In an overlapping context, a pronoun is grammatical in object position (83), while its reflexive counterpart is not (84). This contrasts with the behavior of switch-reference markers, as shown below.<sup>45</sup>

(83) lé: lé-w di-k'ése-ha-yi  
1.PRO 1.PRO-PL 1/1-be.alive-CAUS-IND  
'I saved us (all).'

(84) \*lé: lé-w di-**gum**-k'ése-ha-yi  
1.PRO 1.PRO-PL 1-REFL-be.alive-CAUS-IND  
Intended: 'I saved us (all).'

<sup>45</sup> Baker and Camargo Souza (2020:1103–1108) analyze reflexive constructions in some languages (including Shipibo) as involving the same Agree mechanism as switch reference in these languages. As a reviewer points out, this predicts that reflexives should pattern like switch reference with respect to the overlapping reference cases. While Baker and Camargo Souza don't discuss this prediction, the data in this section show that this unification will not work for Washo. We also note that in a revised version of the analysis proposed in Camargo Souza 2020, this assimilation of reflexives and switch reference is in fact rejected on the basis of evidence from number suppletion in Yawanawa (Camargo Souza 2020:111-119), one of the languages whose switch-reference system is analyzed in Baker and Camargo Souza 2020.

Relatedly, Rooryck (2006) also shows that in English and other languages, a subject can co-occur with a pronoun object with overlapping reference if and only if the *lower* argument (the object) constitutes the superset DP:

- (85) a.  $I_i$  saved  $us_{i,j}$ .  
 b. \* $We_{i,j}$  saved  $me_i$ .

This behavior is again repeated in Washo. Example (83), in which the superset nominal is the object, is grammatical, while the following examples, in which the superset nominal is the subject, is not (regardless of whether the verb is reflexive):

- (86) \*lé-w lé: di-k'éše-ha-yi  
 1.PRO-PL 1.PRO 1/1-be.alive-CAUS-IND  
 Intended: 'We saved me.' *Obj*  $\subset$  *Subj*

This directional asymmetry is not what we see in the case of switch reference, which allows the subset relation to go in either direction (examples repeated from (68)):

- (87) a. *Embedded Sbj*  $\subset$  *Matrix Sbj*  
 [ **Emily** gé:gel-a?-{š/Ø} ] **Adele ida Emily** wagayáy?-i  
 [ **Emily** 3.sit-DEP-{DS/SS} **Adele and Emily** 3.talk-IND  
 'Adele and Emily are talking while Emily is sitting.'  
 b. *Matrix Sbj*  $\subset$  *Embedded Sbj*  
 [ **Adele ida Emily** wagayáy?-a?-{š/Ø} ] **Emily** bašá?-i  
 [ **Adele and emily** 3.talk-DEP-{DS/SS} ] **Emily** 3.write-IND  
 'Emily is writing while Adele and Emily are talking.'

In summary, the binding-theoretic approach to switch reference predicts parallel behavior between this phenomenon and the reflexive and pronominal system in cases of reference overlap, contrary to what the data show.

We note here that Finer (1984:86–129) is aware of the problem posed by cases of overlap and offers a proposal couched in an approach that he calls 'diagonal binding'. The core idea behind diagonal binding is that the subscripted index of one NP may occur as a superscript on another, and that the interpretation of this indexing is that the denotation of one NP overlaps that of another NP. To account for the variation in the way that different languages treat overlapping reference, Finer proposes further that the availability of diagonal binding varies cross-linguistically. While we do not go into his account in any detail here, we point out that his account faces the same problem as any binding approach: It predicts that in cases of overlapping reference, switch reference will behave the same as reflexives and pronouns in the ways discussed above, which is not borne out.

### 7.3 Switch reference as control

Aside from the types of analyses discussed so far in this article, SS marking in switch reference has been treated by Georgi (2012) as an instance of (obligatory) control in the sense of Chomsky (1981). Adopting in particular the movement theory of control

(Hornstein 1999, Boeckx, Hornstein, and Nunes 2010, Grano 2015), Georgi proposes that SS involves movement of the embedded subject to the matrix clause. The morphological realizations for switch reference are exponents of T, and are sensitive to whether this movement has taken place or not.

On the movement theory of control, a DP subject is base-merged in the embedded clause and then moved to an argumental position in the matrix clause:

(88) Jane<sub>i</sub> tried [~~Jane~~<sub>i</sub> to leave ].

Movement of the lower subject to the matrix clause is possible because the DP is still active: it does not receive case from T, which is defective in infinitives.

In treating same-subject marking as obligatory control, Georgi argues that it involves a single argument, generated in the embedded position before undergoing movement to the superordinate argument position. T in the lower clause is sensitive to the lack of an overt DP in its specifier, and spells out as SS. If no movement has taken place on the other hand, that is, if a subject is present in the embedded clause, DS is inserted. Georgi argues in particular that the DS switch-reference marker realizes a head T:

(89) a. which is c-commanded by a head  $\alpha$  that is *not* the root node and that is the closest c-commander for T, and  
 b. in whose accessible domain there is a DP. Georgi 2012:21

In (89), the ban on a c-commanding root node is to rule out DS-marking in matrix clauses. The rules for vocabulary insertion on T are then as follows:

(90) *Vocabulary entries for T in Georgi 2012:22*  
 a.  $/X/ \leftrightarrow T/[\alpha_{[-root]}[ \_ \dots DP ]]$  DS  
 b.  $/X/ \leftrightarrow T/[\alpha_{[-root]}[ \_ ]]$  SS

Crucially, the assimilation of SS marking to obligatory control requires the assumption that T in SS clauses is *always* defective. For the languages Georgi looks at (e.g., Quechua), this is the case: Overt subjects are disallowed in embedded clause, and embedded tense marking is prohibited. Adopting this particular analysis for Washo faces several problems (see Clem 2018 for similar arguments based on Amahuaca).

First, T is not defective in SS-marked clauses in Washo, as they have independent tense morphology (see Section 2). Second, as illustrated, among other examples, in (87), the subject may be overt in the SS-marked clause.

Crucially moreover, the behavior of overlapping reference makes a control-based proposal untenable for Washo. Adopting a control-based account of switch reference leads to the prediction that cases of overlap in switch reference should behave the same as *partial* control. Cases of partial control are exemplified in the following, in which the matrix controller is a subset of embedded PRO (enforced by the presence of items in the embedded clause that force a semantically plural subject):

(91) a. Mary wanted to assemble in the hall.  
 b. Sue expected to go on vacation together.

One important characteristic to show why switch reference does not display the same behavior is the fact that partial control is unidirectional, and is not possible if the referent of PRO is a subset of the referent of the controller:

(92) \*Sue and John expected to go on vacation by herself.

In this example, the anaphor *by herself* ensures that the PRO subject is feminine and singular, thus forcing a reading in which it refers to Sue, who is a member of the referent of the matrix controller. This type of reverse partial control is not possible in Washo either:

(93) \*Adele ida lé: gí:-k'ej di-ʔló:š-gaʔlám-i  
 Adele and 1.PRO 3.PRO-alone 1-dance-want-IND  
 Intended: 'Adele and I want (Adele) to dance by herself.'

Again here, this is different from the pattern that we find in switch reference: SS (and DS) in Washo is bidirectional, as was shown in (87). In sum, the pattern of overlapping reference in switch reference is distinct from observed patterns in control cross-linguistically, which constitutes our final argument against the control theory of switch reference.

## 8 Conclusion

To conclude, the data from Washo provide new insights into the mechanisms of Agree involved in reference tracking. Through the investigation of these data, we hope to have established in this article that switch reference is a syntactic phenomenon, and more narrowly, that it is the surface manifestation of multiple agreement. We have argued for our syntactic, agreement-based account on the basis not only of the appearance of switch-reference morphology in different types of subordinate clauses, but also sensitivity to case, locality restrictions, and reference overlap.

Zooming out to the larger picture, our account makes interesting, testable predictions about possible cross-linguistic variation in the domain of switch reference, which we hope can be tackled in future work. First, Washo allows for switch reference in many different types of embedded clauses, a characteristic that appears to be rare across languages. One open question here concerns the cross-linguistic landscape of the possible clause types that are able to host switch reference, particularly coordination; it is unclear whether the present analysis can be extended to such configurations. While it has been claimed that languages exhibit switch reference in coordination, many apparent cases of this kind may simply be translations as such, and can possibly be re-analyzed as adverbials or otherwise (see Weisser 2016). For instance, McKenzie (2012:167–169, 2015:433) claims that canonical switch reference that tracks arguments is not possible in coordination, at least in the languages of North America, but this claim has been disputed by Keine (2013).

Second, our proposal predicts that, in a language that allows for multiple nominative subjects, switch reference should track the reference of all the nominative subjects in a given sentence. This prediction is borne out by Chickasaw (Muskogean): As shown in Broadwell 1997:34–37 (based on evidence in Munro and Gordon

1982 and Carden et al. 1982), switch reference in an embedded clause is sensitive to the reference of multiple superordinate nominative subjects in possessor-raising configurations.<sup>46</sup>

Third, the proposal that C in Washo probes for nominative arguments only leads to the prediction that the sensitivity of switch reference to case might be governed by Bobaljik's (2008) case hierarchy (unmarked > dependent > lexical/oblique), which constrains which case types are accessible to agreement by specific agreement controllers (e.g. a controller may only access arguments with unmarked case, or arguments with either unmarked or dependent case, but it may not access only arguments with dependent case). In a language with accusative case alignment, a probe restricted to unmarked case (=nominative) tracks transitive and intransitive subjects exclusively, as is the case in Washo. An interesting prediction is that a similarly restricted probe in a language with ergative case alignment will be restricted to absolutive arguments, that is, subjects in intransitive sentences and objects in transitive sentences. This prediction seems to be contradicted by the observation that, overwhelmingly, switch reference specifically tracks subjects crosslinguistically, regardless of case (Foley and Van Valin 1984:117–120, Baker and Camargo Souza 2020:1084–1085). However, this issue can only be addressed by examining particular cases in details, a task that is beyond the scope of the present article. In the following paragraphs, we briefly discuss a few relevant cases from the literature.

Relevant ergative languages include those in the Panoan family (Camacho 2010, Baker and Camargo Souza 2020, Clem 2020), but in these, switch reference is not restricted by case or grammatical function, hence they do not offer evidence for or against our case-based account. Also relevant in this respect is the survey of ergative (Pama-Nyungan) Australian languages with switch reference in Austin 1981. Two different patterns are described in that work. In Warlpiri (and possibly others), switch reference tracks the reference of both objects and subjects across different cases, as in Panoan (Hale 1976).<sup>47</sup> In the other pattern, found for instance in Diyari, switch reference only tracks (transitive or intransitive) subjects, which makes it more directly relevant to our prediction. As shown in Legate (2014) however, Diyari is in fact not ergative, but a 3-case language in which transitive subjects are ergative, intransitive subjects nominative, and direct objects accusative.<sup>48</sup> In our analysis, the fact that switch reference specifically tracks subjects, and not objects, can be accounted for by making the probe specific to ergative and nominative goals, excluding accusative ones. Although Bobaljik's case hierarchy is not fine-grained enough to group nominative and ergative to the exclusion of accusative, this can be achieved with some

<sup>46</sup> Importantly, this prediction is possible because, under our account, Agree can interact with more than one goal (as long as locality conditions on the operation are respected). In the usual case, this is restricted to a single goal above the probe, and another one below the probe. In the relevant multiple-subject constructions, two of the goals are above the probe.

<sup>47</sup> More specifically, switch reference markers in this language track the reference of embedded subjects (not objects) and both matrix subjects and objects.

<sup>48</sup> Furthermore, the language has a nominal split whereby only certain nominals display a full 3-way ergative-nominative-contrast, while others neutralize nominative with either accusative (thus resembling an ergative-absolutive system) or ergative (thus resembling a nominative-accusative system; see Austin 1981:314). Legate (2014) argues that these are case syncretisms, not a direct reflection of the syntax of case in the language.



feature-decomposition analyses of case, such as the one proposed in Kiparsky 1997 (see also Donohue 2004), in which ergatives and nominatives are a natural class defined by the feature [+HR].

Hence, no ergative language that we know of counter-exemplifies our generalizations regarding correlations between case and switch reference. On the other hand, we have not found any ergative language that exemplifies our key prediction mentioned above, namely one in which switch reference tracks (absolutive) intransitive subjects and objects, to the exclusion of (ergative) transitive subjects. Whether this prediction is verified or not will require further detailed work into ergative languages with switch reference.

Finally, an agreement analysis predicts that goal features other than the index may be valued on the probe. This is not the case in Washo, but switch reference morphology often also encodes the case of the tracked arguments in other languages. For example, Clem (2020) argues the Agree probe in Amahuaca switch reference values case features in addition to the index feature (but see Baker and Camargo Souza 2020 for a dissenting view based on other Panoan languages). In addition, person and number features seem to have an effect indirectly in the distribution of same vs. different subject inflection in cases of reference overlap, as discussed in Roberts 2017:552–558.

**Acknowledgements** We thank first and foremost the Washo elders Adele James and Ramona Dick<sup>†</sup> for sharing their language, as well as the wider Washo community for welcoming and helping to facilitate this research. We would also like to thank Mark Baker, Emily Clem, and Livia Camargo Souza for useful criticism of the ideas presented here, as well as the audiences at WSCLA 22, NELS 48, DISCO 5, GLOW 42, and at the University of Chicago. We also thank Amy Rose Deal and three anonymous reviewers for feedback that led to considerable improvement to our initial manuscript. This work was supported in part by The Jacobs Funds and The Phillips Funds for Native American Research.

## References

- Abels, Klaus. 2003. Successive Cyclicity, Antilocality and Adposition Stranding. PhD thesis, University of Connecticut.
- Adger, David. 2003. *Core syntax: A minimalist approach*. Oxford: Oxford University Press.
- Alexiadou, Artemis, and Gereon Müller. 2008. Class features as probes. In *Inflectional identity*, eds. Asaf Bachrach and Andrew Nevins, 102–155. Oxford: Oxford University Press.
- Aoun, Joseph. 1981. The Formal Nature of Anaphoric Relations. PhD thesis, Massachusetts Institute of Technology, Cambridge, MA.
- Arregi, Karlos, and Emily A. Hanink. 2018. Switch Reference in Washo as multiple subject agreement. In *Proceedings of the North East Linguistic Society 48*, eds. Sherry Hucklebridge and Max Nelson, vol 1, 39–48. GLSA Publications.
- Arregi, Karlos, and Andrew Nevins. 2012. *Morphotactics: Basque Auxiliaries and the Structure of Spellout*. Dordrecht: Springer.
- Austin, Peter. 1981. Switch-Reference in Australia. *Language* 57.2: 309–334.

- Baker, Mark. 2008. *The syntax of agreement and concord*. Cambridge University Press.
- Baker, Mark, and Livia Camargo Souza. 2020. Agree without agreement: Switch-reference and reflexive voice in two Panoan languages. *Natural Language and Linguistic Theory* 38: 1053–1114.
- Bárány, András, and Irinia Nikolaeva. 2019. Possessors in switch-reference. *Glossa* 4(1):81: 1–36.
- Béjar, Susana, and Milan Rezac. 2009. Cyclic Agree. *Linguistic Inquiry* 40: 35–73.
- Bhatt, Rajesh. 2005. Long distance agreement in Hindi-Urdu. *Natural Language and Linguistic Theory* 23: 757–807.
- Bjorkman, Bronwyn. 2011. BE-ing default: The morphosyntax of auxiliaries. PhD thesis, Massachusetts Institute of Technology, Cambridge, MA.
- Bjorkman, Bronwyn, and Hedde Zeijlstra. 2019. Checking Up on ( $\phi$ -)Agree. *Linguistic Inquiry* 50.3: 527–629.
- Bobaljik, Jonathan. 2008. Where's phi? Agreement as a post-syntactic operation. In *Phi theory: Phi features across modules and interfaces*, eds. Daniel Harbour David Adger and Susana Béjar, 295–328. Oxford: Oxford University Press.
- Bochnak, M. Ryan. 2015. Variable force modality in Washo. In *North east linguistic society (nels) 45, volume 1*, eds. Thuy Bui and Deniz Özyıldız, Amherst: University of Massachusetts, GLSA Publications, 105–114.
- Bochnak, M. Ryan. 2016. Past time reference in a language with optional tense. *Linguistics and Philosophy* 39: 247–294.
- Bochnak, M. Ryan, and Emily A. Hanink. 2019. Clausal embedding in Washo: Complementation vs. modification. Ms., University of British Columbia and University of Manchester.
- Bochnak, M. Ryan, Timothy Grinsell, and Alan Yu. 2011. Copula agreement and the stage-level/individual-level distinction in Washo. In *UBC Working Papers in Linguistics: Proceedings of the 16th Workshop on the Structure and Constituency in the Languages of the Americas*, eds. Meagan Louie and Alexis Black. The University of British Columbia.
- Boeckx, Cedric, Norbert Hornstein, and Jairo Nunes. 2010. *Control as movement*. New York: Cambridge University Press.
- Bošković, Željko. 2004. Object Shift and the Clause/PP Parallelism Hypothesis. In *The Proceedings of West Coast Conference on Formal Linguistics 23*, eds. B. Schmeiser, V. Chand, A. Kelleher, and A. Rodriguez, 101–114. Somerville, MA: Cascadilla Press.
- Bošković, Željko. 2015. From the complex NP constraint to everything: On deep extractions across categories. *The Linguistic Review* 603–669.
- Broadwell, George Aaron. 1990. Extending the binding theory: A Muskogean case study. PhD thesis, University of California, Los Angeles.
- Broadwell, George Aaron. 1997. Binding Theory and Switch Reference. In *Atomism and Binding*, eds. Hans Bennis, Pierre Pica, and Johan Rooryck, 31–49. Dordrecht: Foris.
- Broadwell, George Aaron. 2006. *A Choctaw reference grammar*. Lincoln, NB: University of Nebraska Press.

- Bruce, Les P. 1984. *The Alamlak language of Papua New Guinea (East Sepik)*. Canberra: Pacific Linguistics.
- Camacho, José. 2010. On case concord: The syntax of switch-reference clauses. *Natural Language and Linguistic Theory* 28: 239–274.
- Camargo Souza, Livia. 2020. Switch-reference as anaphora: A modular account. PhD thesis, Rutgers University.
- Campbell, Lyle. 1997. *American Indian Languages: The Historical Linguistics of Native America*. Oxford University Press.
- Carden, Guy, Lynn Gordon, and Pamela Munro. 1982. Raising rules and the Projection Principle. Ms., University of California, Los Angeles.
- Carstens, Vicki. 2016. Delayed valuation: A reanalysis of goal features, “upward” complementizer agreement, and the mechanics of case. *Syntax* 19: 1–42.
- Chomsky, Noam. 1973. Conditions on transformations. In *A Festschrift for Morris Halle*, eds. Stephen Anerson and Paul Kiparsky, 232–286. New York: Holt, Rinehart & Winston.
- Chomsky, Noam. 1981. *Lectures on Government and Binding*. Foris.
- Chomsky, Noam. 2000. Minimalist inquiries: The framework. In *Step by step: Essays on Minimalist syntax in honor of Howard Lasnik*, eds. Roger Martin, David Michaels, and Juan Uriagereka, 89–155. Cambridge, MA: MIT Press.
- Chomsky, Noam. 2001. Derivation by phase. In *Ken Hale: A Life in Language*, ed. M. Kenstowicz, 1–52. MIT Press.
- Citko, Barbara. 2014. *Phase theory: An introduction*. Cambridge University Press.
- Clem, Emily. 2018. Against non-reference-tracking theories of switch-reference. In *Proceedings of the linguistic society of america 3*, ed. Patrick Farrell, Washington, DC: Linguistic Society of America, 29:1–9.
- Clem, Emily. 2019. Object-sensitive switch-reference and insatiable probes. In *Proceedings of the north east linguistic society 49*, eds. Maggie Baird and Jonathan Pesetsky, Amherst, MA: GLSA, vol 1, 173–186.
- Clem, Emily. 2020. Cyclic expansion in Agree: Maximal projections as probes. Ms., University of California, San Diego.
- Dahlstrom, Amy. 1982. A functional analysis of switch-reference in Lakhota discourse. In *Chicago linguistic society (cls) 18*, eds. Kevin Tuite, Robinson Schneider, and Robert Chametsky, University of Chicago: Chicago Linguistic Society, 72–81.
- Deal, Amy Rose. 2015. Interaction and satisfaction in  $\phi$ -agreement. In *The Proceedings of the Forty-Fifth Annual Meeting of the North East Linguistic Society*, eds. Thuy Bui and Deniz Özyıldız, vol 1, 179–192. UMass Amherst: GLSA.
- Deal, Amy Rose. 2017a. Syntactic ergativity as case discrimination. In *A schrif to fest Kyle Johnson*, eds. Aaron Kaplan, Abby Kaplan, Miranda K. McCarvel, and Edward J. Rubin, 141–150. Cascadilla Proceedings Project.
- Deal, Amy Rose. 2017b. Towards an etiology of outer indices. In *A schrif to fest Kyle Johnson*, eds. Keir Moulton Nicholas LaCara and Anne-Michelle Tessier, 107–117. Linguistics Open Access Publications.
- Deal, Amy Rose. 2020. Interaction, satisfaction, and the PCC. Ms., UC Berkeley <https://ling.auf.net/lingbuzz/005114>.

- Diercks, Michael. 2013. Indirect agree in Lubukusu complementizer agreement. *Natural Language and Linguistic Theory* 31.2: 357–407.
- Diercks, Michael, Marjo van Koppen, and Michael Putnam. 2017. Anaphoric and Non-anaphoric feature valuation. Ms., Pomona College, Penn State University, and University of Utrecht.
- den Dikken, Marcel. 2006. A reappraisal of vP being phasal – A reply to Legate. Ms., CUNY Graduate Center.
- den Dikken, Marcel. 2010. On the Functional Structure of Locative and Directional PPs. In *Mapping Spatial PPs: The Cartography of Syntactic Structures*, eds. G. Cinque and L. Rizzi, 74–126. Oxford University Press.
- Donohue, Cathryn. 2004. Morphology matters: Case licensing in Basque. PhD thesis, Stanford University.
- Douros, Darby. 2019. Person marking in Washo as agreement with clitic movement. BA thesis, The University of Chicago.
- Drummond, Alex, Norbert Hornstein, and Howard Lasnik. 2010. A Puzzle about P-Stranding and a Possible Solution. *Linguistic Inquiry* 41: 689–692.
- Enç, Mürvet. 1989. Pronouns, licensing, and binding. *Natural Language and Linguistic Theory* 7: 51–92.
- Finer, Daniel. 1984. The formal grammar of switch-reference. PhD thesis, UMass Amherst.
- Finer, Daniel. 1985. The syntax of switch-reference. *Linguistic Inquiry* 16: 35–55.
- Foley, William, and Robert Van Valin. 1984. *Functional syntax and universal grammar*. Cambridge: Cambridge University Press.
- Georgi, Doreen. 2012. Switch-Reference by Movement. In *Perspectives on switch-reference: Local modeling and empirical distribution*, ed. Philipp Weisser, 1–40. Linguistische Arbeitsberichte, Universität Leipzig.
- Grano, Thomas. 2015. *Control and restructuring*. Oxford: Oxford University Press.
- Grosz, Patrick. 2015. Movement and agreement in Right-Node Raising constructions. *Syntax* 18: 1–38.
- Hale, Kenneth. 1976. The adjoined relative clause in Australia. In *Grammatical categories in Australian languages*, ed. Robert M.W. Dixon, 78–105. Canberra: AIAS.
- Hanink, Emily. 2016. Internally headed relatives and event nominalizations in Washo. In *Berkeley linguistics society (bls) 42*, eds. Emily Clem, Virginia Dawson, Alice Shen, Amalia Skilton, Geoff Bacon, Andrew Cheng, and Erik Maier, University of California, Berkeley: Berkeley Linguistics Society, 119–134.
- Hanink, Emily, and M. Ryan Bochnak. 2018. Factivity and two types of embedded clauses in Washo. In *North east linguistic society (nels) 47, volume 2*, eds. Andrew Lamont and Katerina Tetzloff, Amherst: University of Massachusetts, GLSA Publications, 65–78.
- Hanink, Emily, and Julian Grove. 2017. German Relative Clauses and the Severed Index Hypothesis. In *Proceedings of wccfl 34*, eds. Miranda K. McCarvel Aaron Kaplan, Abby Kaplan and Edward J. Rubin, 241–248. Cascadilla Proceedings Project.
- Hanink, Emily A. 2021. DP Structure and internally headed relatives in Washo. *Natural Language & Linguistic Theory* 39(2): 505–554.
- Harbour, Daniel. 2007. *Morphosemantic number: From Kiowa noun classes to UG number features*. Dordrecht: Springer.

- Harbour, Daniel. 2011. Valence and atomic number. *Linguistic Inquiry* 42: 561–594.
- Heim, Irene, and Angelika Kratzer. 1998. *Semantics in Generative Grammar*. Malden, MA: Blackwell.
- Hicks, Glyn. 2009. *The derivation of anaphoric relations*. Amsterdam: John Benjamins.
- Hiraiwa, Ken. 2000. Agree and closeness in multiple specifiers. Ms., Massachusetts Institute of Technology.
- Hiraiwa, Ken. 2001. Multiple Agree and the Defective Intervention Constraint in Japanese. In *Humit student conference in language research (humit) 1*, eds. Ora Matushansky, Ken Hiraiwa, Albert Costa, Javier Martín-González, Lance Nathan, and Adam Szczegielniak, MIT Working Papers in Linguistics 40. Cambridge, MA: MIT Working Papers in Linguistics, 67–80.
- Hornstein, Norbert. 1999. Movement and control. *Linguistic Inquiry* 30: 69–96.
- Jacobsen, William. 1964. A grammar of the Washo language. PhD thesis, University of California, Berkeley.
- Jacobsen, William. 1967. Switch-reference in Hokan-Coahuiltecan. In *Studies in Southwestern linguistics*, eds. Dell Hymes and William Bittle, 238–263. The Hague: Mouton.
- Jacobsen, William. 1979. Why does Washo lack a passive? In *Ergativity: Towards a theory of grammatical relations*, ed. F. Plank, 145–160. London: Academic Press.
- Jacobsen, William. 1996. *Beginning Washo*. Carson City, NV: Nevada State Museum.
- Jacobsen, William. 1998. Headless relative clauses in Washo. In *Studies in American Indian languages: Description and theory*, eds. Leanne Hilton and Pamela Munro, 102–116. Berkeley, CA: University of California Press.
- Kayne, Richard. 1994. *The Antisymmetry of Syntax*. MIT Press.
- Kayne, Richard. 2004. Prepositions as Probes. In *Structures and Beyond: The cartography of syntactic structures*, ed. A. Belletti, vol 3, 192–212. Oxford University Press.
- Keine, Stefan. 2013. Deconstructing switch-reference. *Natural Language and Linguistic Theory* 31: 767–826.
- Keine, Stefan. 2020. *Probes and Their Horizons*. Cambridge, MA: MIT Press.
- Kennedy, Chris. 2014. Predicates and formulas: Evidence from ellipsis. In *The art and craft of semantics: A Festschrift for Irene Heim, Volume 1*, eds. Luka Crnić and Uli Sauerland, 83–136. Cambridge, MA: MIT Working Papers in Linguistics.
- Kiparsky, Paul. 1997. The rise of positional licensing. In *Parameters of morphosyntactic change*, eds. Ans van Kemenade and Nigel Vincent, 460–494. Cambridge: Cambridge University Press.
- van Koppen, Johanna Maria. 2005. One probe – two goals: Aspects of agreement in Dutch dialects. PhD thesis, Leiden University.
- Kratzer, Angelika. 2009. Making a pronoun: Fake indexicals as windows into the properties of pronouns. *Linguistic Inquiry* 40.2: 187–237.
- Lasnik, Howard. 1981. On two recent treatments of disjoint reference. *Journal of Linguistic Research* 1: 48–58.
- Lee-Schoenfeld, Vera. 2008. Binding, Phases, and Locality. *Syntax* 11.3: 281–298.
- Legate, Julie. 2014. Split ergativity based on nominal type. *Lingua* 148: 183–212.

- Matushansky, Ora. 2005. Going through a phase. In *Perspectives on phases*, eds. M. McGinnis and N. Richards, 157–181. Cambridge, MA: MIT Working Papers in Linguistics.
- McCloskey, Jim. 1997. Subjecthood and subject positions. In *Elements of grammar*, 197–235. Springer Netherlands.
- McKenzie, Andrew. 2012. The role of contextual restriction in reference-tracking. PhD thesis, University of Massachusetts, Amherst.
- McKenzie, Andrew. 2015. A survey of switch-reference in North America. *International Journal of American Linguistics* 81: 409–448.
- Merchant, Jason. 2006. Polyvalent case, geometric hierarchies, and split ergativity. In *Proceedings from the Annual Meeting of the Chicago Linguistic Society*, eds. Jackie Bunting, Sapna Desai, Robert Peachey, Chris Straughn, and Zuzana Tomkova, vol 2: The Parasessions, 47–67. Chicago Linguistic Society.
- Merchant, Jason. 2011. Aleut case matters. In *Pragmatics and Autolexical Grammar: In honor of Jerry Sadock*, 382–411. John Benjamins: Amsterdam.
- Mithun, Marianne. 1999. *The Languages of North America*. Cambridge University Press.
- Munro, Pamela, and Lynn Gordon. 1982. Syntactic relations in Western Muskogean: A typological perspective. *Language* 58: 81–115.
- Nevins, Andrew. 2007. The representation of third person and its consequences for person-case effects. *Natural Language and Linguistic Theory* 25: 273–313.
- Nevins, Andrew. 2011. Multiple agree with clitics: person complementarity vs. omnivorous number. *Natural Language and Linguistic Theory* 29: 939–971.
- Nevins, Andrew, and Coppe van Urk. 2020. Syntactic asymmetries in switch reference. In *Proceedings of the north east linguistic society 50*, eds. Mariam Asatryan, Yixiao Song, and Ayana Whitmal, GLSA Publications, vol 1, 225–234.
- Nonato, Rafael. 2014. Clause chaining, switch reference, and coordination. PhD thesis, Massachusetts Institute of Technology, Cambridge, MA.
- Noyer, R. Rolf. 1992. Features, positions and affixes in autonomous morphological structure. PhD thesis, MIT, Cambridge, MA.
- Peachey, Robert M. 2006. On switch-reference and the internally-headed relative clause construction in Washo. Ms., University of Chicago.
- Postal, Paul. 1966. A note on ‘understood transitively’. *International Journal of American Linguistics* 32: 90–93.
- Postal, Paul. 1969. Review of A. McIntosh and M.A.K. Halliday, *Patterns of language: Papers in general descriptive and applied linguistics*. *Foundations of Language* 5: 409–439.
- Preminger, Omer. 2014. *Agreement and its failures*, vol 68. Cambridge, MA: MIT Press.
- Rezac, Milan. 2004. Agree and Merge: Locality in copy-raising. In *Journées d’Études linguistiques (jel) 2004*, eds. Olivier Crouzet, Hamida Demirdache, and Sophie Wauquier-Gravelines, University of Nantes, Department of Humanities and Languages, 205–210.
- Roberts, John R. 1987. *Amele*. London: Croon Helm.
- Roberts, John R. 1988. Amele switch-reference and the theory of grammar. *Linguistic Inquiry* 24: 657–720.

- Roberts, John R. 2017. A typology of switch reference. In *The Cambridge Handbook of Linguistic Typology*, eds. Alexandra Y. Aikhenwald and R.M.W. Dixon, 538–573. Cambridge University Press.
- Rooryck, Johan. 2006. Binding into pronouns. *Lingua* 116.10: 1561–1579.
- Rullmann, Hotze. 2003. Bound-variable pronouns and the semantics of number. In *Proceedings of the western conference on linguistics: Wecol 2002*, eds. Brian Agbayani, Paivi Koskinen, and Vida Samiiian, Department of Linguistics, California State University, Fresno, 243–254.
- Safir, Ken. 2004. *The syntax of anaphora*. Oxford: Oxford University Press.
- Sportiche, Dominique. 1985. Remarks on crossover. *Linguistic Inquiry* 16: 460–469.
- Stirling, Lesley. 1993. *Switch-reference and discourse representation*. Cambridge University Press.
- Svenonius, Peter. 2004. On the edge. In *Peripheries: Syntactic edges and their effects*, ed. David Adger et al., 259–287. Dordrecht: Kluwer.
- Valenzuela, Pilar. 2003. Transitivity in Shipibo-Konibo Grammar. PhD thesis, University of Oregon.
- Watanabe, Akira. 2000. Feature copying and binding: Evidence from complementizer agreement and switch reference. *Syntax* 3: 159–181.
- Weisser, Philipp. 2015. *Derived Coordination: A Minimalist Perspective on Clause Chains, Converbs and Asymmetric Coordination*. Berlin: de Gruyter.
- Weisser, Philipp. 2016. Is there Switch-Reference Marking in Coordinated Clauses? In *Switch reference 2.0*, eds. R. van Gijn and Jeremy Hammond, 93–114. Amsterdam: John Benjamins.
- Wurmbrand, Susi. 2012. Parasitic participles: Evidence for the theory of verb clusters. *Taal en Tongval* 64: 129–156.
- Wurmbrand, Susi. 2014. The Merge Condition: A syntactic approach to selection. In *Minimalism and beyond: Radicalizing the interfaces*, eds. Peter Kosta, Lilia Schürcks, Steven Franks, and Teodora Radev-Bork, 139–177. Amsterdam: John Benjamins.
- Yu, Alan. 2005. Quantity, stress, and reduplication in Washo. *Phonology* 22(3): 437–475.
- Zeijlstra, Hedde. 2004. Sentential Negation and Negative Concord. PhD thesis, University of Amsterdam.