

Jim Wood

Icelandic nominalizations and allosemy

Friday 5th May, 2023

To my mother, Mary Wood-Gauthier.

Acknowledgments

This book has been a long time coming. I have been fascinated by nominalizations since long before I began working on this project, and all the while I strongly suspected that there was a lot that we could learn by studying Icelandic nominalizations. When I finally started to work on it in earnest, I quickly realized that if anything, I had drastically *underestimated* the wealth of data with profound theoretical implications that one could find in this area. Indeed, I feel that this book really only scratches the surface. The topic is almost overwhelmingly endless—as infinitely open as the linguistic system itself and the worlds it is used to describe. For now, I think that there is enough to make some basic, fundamental points about the architecture of grammar, and I am confident that future studies will go even deeper.

I am grateful to so many people who have listened to me, inspired me, worked with me and supported me over the last few years on this project, from the students who engaged with course lectures that connected with this topic to the native speakers who took the time to share their judgments and ideas with me. At Yale, I am grateful to the undergraduate and graduate students who have taken my courses in morphosyntax and to the syntax reading/research group who have provided feedback on various stages of the project. I am especially grateful to Bob Frank and Raffaella Zanuttini, for their support and feedback, and to Sigríður Sigurðardóttir, who otherwise defies categorization in these acknowledgments: she has been a student, a consultant, and even a collaborator. I am also especially grateful to Catarina Soares for her collaboration and help with aspects of the section on *-vaða* verbs. Thanks to Matt Tyler and Milena Šereikaitė for many challenging but deeply enlightening conversations about these topics.

In developing the ideas in this book, I have benefitted tremendously from so many conversations with so many linguists that I can't possibly list them all here. But I would like to especially thank my fellow NYU alumni Neil Myler, Itamar Kastner, and Tricia Irwin for their friendship and their engagement in the development of these ideas over the years, as well as Alec Marantz for his support and for continuing to inspire me and pushing the boundaries of what I think is possible.

Aspects of this work have been presented in numerous venues over the years, including at the Ulster Linguistics Research Seminar, the 93rd Linguistic Society of America meeting (LSA 93), the MarantzFest conference at New York University, the 2019 Princeton Symposium on Syntactic Theory (PSST), the 43rd Annual Conference of the German Linguistic Society (DGfS 43), and the 9th Workshop on Nominalizations (9èmes Journées d'Etude sur les NOMinalisations) (JENom 9), in addition to invited presentations at a University of Iceland, University of Arizona, Swarthmore College, University of Pennsylvania, Rutgers University, and University of Massachusetts, Amherst. I have learned a lot from the audiences at these presentations, and I am grateful for their interest and their feedback.

Perhaps more than anything else, I am grateful to the Icelanders who took the time to discuss the subject matter of this work with me in numerous ways. I am especially grateful to Anton Karl Ingason, Einar Freyr Sigurðsson and Gísli Harðarson, who have provided more inspiration and engaging comments than I could possibly do justice to here. I am also particularly grateful to Jóhannes Gísli Jónsson for helping me make the most of my trips to Iceland and helping me find an ever-increasing number of speakers to talk to, and to Halldór Ármann Sigurðsson for detailed comments on several versions of this work. I gratefully acknowledge that parts of this work, particularly those connected with ditransitives, were supported in part by Icelandic Research Fund grant 195926-051 “Ditransitives in Insular Scandinavian,” directed by Jóhannes Gísli Jónsson and Cherlon Ussery. Finally, I am grateful to the people who have taken the time to give me their judgments and very often thoughtful comments on the Icelandic data at the center of this book. I have tried to be as comprehensive as possible in keeping track of everyone, but if there is anyone out there I have not included, please accept my deepest thanks and apologies: Anton Karl Ingason, Atli Snær Ásmundsson, Ása Bergný Tómasdóttir, Ásgrímur Angantýsson, Bolli Magnússon, Dagbjört Guðmundsdóttir, Einar Freyr Sigurðsson, Eiríkur

Rögnvaldsson, Eva Hrund Sigurjónsdóttir, Gísli Rúnar Harðarson, Halla Hauksdóttir, Halldór Ármann Sigurðsson, Hinrik Hafsteinsson, Iris Edda Nowenstein, Jóhannes Gísli Jónsson, Kristín Bjarnadóttir, Kristín Björg Björnsdóttir, Kristín Jóhannsdóttir, Lilja Björk Stefánsdóttir, Oddur Snorrason, Salome Lilja Sigurðardóttir, Sigríður Sigurjónsdóttir, Sigríður Mjöll Björnsdóttir, Sigríður Sæunn Sigurðardóttir, Þorbjörg Þorvaldsdóttir, Þórhallur Eyþórsson. I would especially like to express my deep gratitude to Einar Freyr Sigurðsson for doing a last minute check of the Icelandic examples. Of course, any remaining errors or misinterpretations are entirely my own responsibility.

The period of time I spent on this book straddles the 2020 coronavirus pandemic, about which I don't need to say much to anyone who was alive during that time. Suffice it to say for present purposes that although this book's completion was substantially delayed as a result of the pandemic, I owe a special debt of gratitude to everyone who helped me get through that period, professionally and personally, and saw me to the other side, typing these words: my colleagues at Yale, who were endlessly patient and unrelentingly supportive; my kids Hugo and Daria, who were 6-7 and 3-4 years old (respectively), and endured 9 full months at home with very tired and frustrated parents; my mom and George, who took our family in for 4 of those months; my wife Julia, who somehow managed to pull that year off with me, even though she was working full time just as much as I was. I love you all. Thank you.

Abstract

The broad aim of this book is to bring a basic, but detailed description of Icelandic nominalizations to bear on the general theoretical and architectural issues that nominalizations have raised since the earliest work in generative syntax. While nominalization has long been central to theories of argument structure, and Icelandic has been an important language for the study of argument structure and syntax, Icelandic has not been brought into the general body of theoretical work on nominalization. In this book, I show that Icelandic-specific issues in the analysis of derived nominals have broad implications that go beyond the study of that one language. In particular, Icelandic provides special evidence that Complex Event Nominals (CENs), which seem to inherit their argument structure from the underlying verbs, can be formed without nominalizing a full verb phrase. This conclusion is at odds with prominent theories of nominalization which claim that CENs have the properties that they have precisely *because* they involve the nominalization of full verb phrases.

More narrowly, I aim to develop the theory of allosemy within the framework of Distributed Morphology to account for the ambiguity of nominalizations and inheritance of argument structure. In so doing, I will show how one single syntactic structure can get distinct semantic interpretations corresponding to the range of readings that are available to derived nominals. The idea is that just as the phonological realization of terminal nodes is underspecified in syntax (so that before Vocabulary Insertion, past tense *-ed* and past tense *-t* are the same T_{PAST} head), the semantic interpretation of terminal nodes is underspecified in syntax as well. Late insertion at LF inserts suppletive allosemes—semantic denotations—into terminal nodes that are underspecified semantically. I argue that the single structure at issue derives a noun from a verb before any arguments are attached, by adjoining a lexical root to a *v*(erb) head and adjoining the resulting verb to a *n*(oun) head. In addition to showing how an account grounded in allosemy can derive the ambiguity, I also explore the consequences of building nominalizations entirely with complex heads for the locality of special meanings, and articulate the function of prepositions and prefixing in Icelandic lexical meaning.

The result is a broad argument for what Icelandic nominalizations tell us about argument structure and the syntax-semantics interface, along with an articulated theoretical proposal that makes several novel claims about the syntax-semantics interface within Distributed Morphology.

Contents

| | | |
|----------|---|----|
| 1 | Introduction | 1 |
| 1.1 | Basic issues in nominalizations | 1 |
| 1.2 | Three basic approaches | 2 |
| 1.2.1 | Parallel Structures analysis | 2 |
| 1.2.2 | Phrasal Layering analysis | 4 |
| 1.2.3 | Complex Head Analysis | 8 |
| 1.2.4 | Beyond the three-way ambiguity | 9 |
| 1.2.5 | Why Icelandic nominalizations? | 11 |
| 1.3 | Proposal | 13 |
| 1.3.1 | (Contextual) Allosemy | 13 |
| 1.3.2 | The syntax-semantics interface | 17 |
| 1.3.2.1 | Zeros and pruning | 17 |
| 1.3.2.2 | Semantic types | 18 |
| 1.3.2.3 | Composition rules | 19 |
| 1.3.2.4 | The interpretation of roots | 20 |
| 1.3.3 | Compounding vs. Derivation | 21 |
| 1.4 | Background on Icelandic DP structure | 23 |
| 1.4.1 | Basic DP structure | 23 |
| 1.4.2 | Licensing genitives and genitive complements | 26 |
| 1.4.3 | Is there “quirky case” in Icelandic DPs? | 27 |
| 1.4.4 | Take-home points about DP structure | 31 |
| 1.5 | About the data in this book | 31 |
| 1.6 | Outline of the remainder of the book | 31 |
| 2 | Icelandic nominalizations | 33 |
| 2.1 | Morphology and allomorphy | 33 |
| 2.1.1 | Realizations of <i>n</i> and <i>v</i> | 33 |
| 2.1.2 | The Icelandic theme vowel <i>-a</i> is not a verbalizer | 36 |
| 2.1.3 | The gender of derived nominals | 37 |
| 2.1.4 | P-prefixing in derived nominals: A first look | 39 |
| 2.2 | Complex event nominals | 40 |
| 2.2.1 | Basic CEN diagnostics | 40 |
| 2.2.2 | Allomorphs of <i>n</i> in CENs | 43 |
| 2.2.3 | A note on zero-derived nominals | 43 |
| 2.3 | Further scrutiny of CEN diagnostics | 44 |
| 2.3.1 | Obligatoriness of internal arguments | 45 |
| 2.3.2 | Pluralization of CENs | 47 |
| 2.3.3 | Adjectival modifiers | 48 |
| 2.3.4 | Agentive by-phrases | 50 |
| 2.3.5 | Nominalization of ECM structures | 50 |

| | | |
|----------|---|------------|
| 2.3.6 | The susceptibility of nominalizations to apparent counterexamples | 52 |
| 2.3.7 | Pluralia tantum and nominalizations | 53 |
| 2.4 | Presence/absence of <i>v</i> in nominalizations | 55 |
| 2.4.1 | Eventive readings and Borer's generalization | 55 |
| 2.4.2 | Overt <i>v</i> morphology | 56 |
| 2.5 | Presence/absence of Voice in nominalizations | 57 |
| 2.5.1 | Overt Voice morphology | 57 |
| 2.5.2 | Passive vs. Unaccusative Readings | 60 |
| 2.5.3 | Self-Action Reading | 62 |
| 2.5.4 | Restrictions on the subject | 62 |
| 2.5.5 | Agentive modifiers | 63 |
| 2.5.6 | Binomial <i>Each</i> | 65 |
| 2.5.7 | Summary of VoiceP Diagnostics | 65 |
| 2.6 | Summary | 65 |
| 3 | Phrasal layering vs. complex heads | 67 |
| 3.1 | Case (non-)inheritance supports complex heads | 67 |
| 3.1.1 | Dative direct object themes | 67 |
| 3.1.2 | Dative themes of unaccusatives | 71 |
| 3.1.3 | On DP-internal datives | 74 |
| 3.1.4 | Icelandic datives are not low unmarked datives | 75 |
| 3.1.5 | Other case frames | 75 |
| 3.1.6 | Should we even expect case patterns to be inherited? | 79 |
| 3.2 | Other problems for phrasal layering | 85 |
| 3.2.1 | The problem of <i>á</i> -PPs | 85 |
| 3.2.2 | Nominalizations of ditransitive verbs | 88 |
| 3.2.3 | Nominalizations of <i>-st</i> verbs | 95 |
| 3.2.4 | Synthetic compounds | 97 |
| 3.3 | Summary | 102 |
| 4 | Prepositions and prefixes | 103 |
| 4.1 | Proposal: Structural constraints on allosemy | 104 |
| 4.2 | Prefixing to verbs | 106 |
| 4.3 | Prefixing to derived nominals | 108 |
| 4.3.1 | Pattern 1: Prefixing and doubling | 108 |
| 4.3.2 | Pattern 2: Prefixing only | 112 |
| 4.3.3 | Pattern 3: Nominal selects the same PP | 114 |
| 4.3.4 | The 'gratuitous prefixing' effect | 116 |
| 4.3.5 | Mixed Patterns: Doubling optional | 117 |
| 4.3.6 | Prepositional prefixing and RNs | 120 |
| 4.4 | Prepositions as probes: An alternative phrasal layering analysis | 121 |
| 4.5 | Conclusion | 127 |
| 5 | Complex Event Nominals and Inheritance | 129 |
| 5.1 | The interpretation of nominals, simple version | 129 |
| 5.1.1 | A first approximation of the three basic readings | 130 |
| 5.1.2 | The internal argument of complex event nominals | 132 |
| 5.1.3 | The external argument of complex event nominals | 134 |
| 5.1.4 | Voice diagnostics or agent diagnostics? | 136 |
| 5.1.5 | A note on Borer's Generalization | 138 |
| 5.2 | The interpretation of nominals, building event structure | 140 |
| 5.2.1 | The interpretation of roots and themes | 140 |
| 5.2.2 | Experiencer verbs and stimuli | 144 |
| 5.2.3 | Agent Nominals | 147 |

| | | |
|----------|---|------------|
| 5.2.4 | Synthetic Compounds | 152 |
| 5.3 | When and why are arguments obligatory? | 157 |
| 5.4 | Summary | 158 |
| 6 | Simple Event Nominals, Referring Nominals and Allosemy | 159 |
| 6.1 | The locality of allomorphy | 160 |
| 6.2 | Contextually-conditioned allosemy in the three basic readings | 162 |
| 6.3 | The locality of allosemy: RNs and idiosyncratic meaning | 165 |
| 6.4 | <i>Marg-</i> ‘many’ and <i>endur-</i> ‘re-’ prefixation | 171 |
| 6.4.1 | <i>Marg-</i> ‘many’ prefixation | 171 |
| 6.4.2 | <i>Endur-</i> ‘re-’ prefixation | 176 |
| 6.5 | The absence of idiosyncratic RNs in <i>-væð-ing</i> nominals | 180 |
| 6.5.1 | <i>-væða</i> attaches to categorized words | 182 |
| 6.5.2 | PP complements are compositional | 183 |
| 6.5.3 | No “deverbal P-prefixing” in <i>-væðing</i> nouns | 185 |
| 6.5.4 | Meaning of <i>-væðing</i> nouns is built on verb meaning | 187 |
| 6.5.5 | The interpretation must be compositional | 188 |
| 6.5.6 | The interpretation of <i>-væða</i> verbs | 190 |
| 6.5.7 | <i>-væða</i> as its own verb | 192 |
| 6.5.8 | Take-home points about <i>-væða</i> verbs | 193 |
| 6.6 | The allosemes of n | 193 |
| 6.7 | Summary | 194 |
| 7 | Conclusion | 195 |
| | References | 197 |

Chapter 1

Introduction

1.1 Basic issues in nominalizations

Two foundational observations about deverbal ‘event’ nominalizations are their systematic ambiguity, and their apparent ability to inherit argument structure from their verbal base (cf. Grimshaw 1990). First, the ambiguity refers to the fact that deverbal event nouns systematically have three readings: complex event, simple event, and referential/entity, with no morphological distinction between the three.

- (1) a. **Complex Event Nominal (CEN)**: The detective’s **examination** of the evidence took a long time.
- b. **Simple Event Nominal (SEN)**: The **examination** took a long time.
- c. **Result/Referential Nominal (RN)**: The **examination** was on the table.

While the distinction between CENs and SENs may be debatable—we return to this below—Lieber (2017) points out an interesting generalization about nominalizing affixes in English. For every affix that can form an event noun from a verb, including *-ing*, *-ation*, *-ment*, *-al*, etc., that affix will also be able to form some kind of referential noun from a verb. I will refer to this as Lieber’s Generalization. Thus, there is a systematic ambiguity of form that goes beyond the properties of any individual affix (as identified by morphophonology).

Second, when a noun has the CEN reading, it generally seems to inherit its argument structure from the verb. Consider the examples in (2).

- (2) a. The teacher examined {the evidence / #the students}.
- b. the teacher’s examination of {the evidence / #the students}

For many speakers, myself included, the verb *examine* cannot mean ‘administer an exam to someone’. Therefore, *the students* in (2a) is infelicitous, as it can only mean that the teacher looked at the students closely, perhaps with a magnifying glass. This meaning is inherited by the nominalization *examination* in (2b). Even if one rejects the distinction between SEN and CEN readings, it remains that deverbal event nouns, when they have argument structure, inherit that argument structure from the corresponding verb. Even more strikingly, as we will discuss below, Borer (2014) has argued that nouns with a CEN reading are always derived from an existing, attested, morphologically-related verb. I will refer to this as Borer’s Generalization, which, along with inheritance more generally, suggests that the CEN reading of a nominal depends in some way on the derivational history of that nominal.¹

I contend that there is a general tension between these two foundational observations. On the one hand, the systematic ambiguity suggests that all three readings should come from the same structure (cf. Melloni 2010, 163). If they did not, then the apparent “ambiguity” would really stem from the fact that the morphology happens to not reflect the structural distinction deriving the difference. But this would be at odds with the fact that it is found across so many languages, with so many different morphological properties, and even across many different affixes within the same language. On the other hand, argument structure inheritance suggests that that structure should contain verbal argument structure. But argument structure is lacking in the SEN and RN readings, and it seems highly counterintuitive to

¹ As discussed further below (see footnote 26), Lieber and Borer are not necessarily the first to make observations along these lines. I refer to them as Lieber’s Generalization and Borer’s Generalization because these generalizations play a particularly prominent role in their respective theoretical work.

propose that the argument structure information is simply lost or ignored in these readings (see Koontz-Garboden 2007 on the “Monotonicity Hypothesis”). Thus, researchers have been led to propose different structures for the different readings. But this approach makes the ambiguity something of an accident; it is the result of the “extra structure” being systematically unpronounced.²

In this book, I aim to develop an approach to nominalization that resolves this general tension. First, I propose that Icelandic deverbal nouns, even in the CEN reading, are built by combining heads directly, rather than by nominalizing whole verb phrases, as is often proposed. Second, I argue that this is possible if we recognize that categorizing heads can be subject to (contextual) allosemy, determined in semantics. Specifically, *v* and *n* heads can get contentful or zero interpretations, in a one-to-many relation from syntax to semantics. But the determination of this interpretation is entirely in the semantics, so the morphology is not sensitive to it. This is why the resulting form is ambiguous: the morphological form of a structure is determined in a way that does not have access to information about how the semantics uses that structure. All readings are built off of the same structure, but (some) argument structure can be inherited when *v* takes a contentful interpretation. Borer’s Generalization follows from the claim that CEN readings are fundamentally verbal meanings, so nouns that have such meanings must be derived from a structure that contains a verb, syntactically. Lieber’s Generalization follows because for a deverbal nominalizing affix to get an event reading, it must be the realization of a structure where a noun is built off of a verb. But once the affix in question is understood to realize that structure, the same structure can correspond RN readings in the semantics.

In this introductory chapter, I will frame the issues surrounding nominalizations, introduce the basic proposal to be defended, and provide the necessary background information on the theoretical framework adopted here, and on the points of Icelandic syntax that need to be understood in order to follow the argumentation in the chapters that follow.

1.2 Three basic approaches

In this section, I outline three basic approaches to nominalization within Distributed Morphology, which I refer to as the Parallel Structure, Phrasal Layering, and Complex Head analyses. The latter is what I will be arguing in favor of in this book, and it combines aspects of both the Parallel Structure and the Phrasal Layering analyses.

1.2.1 Parallel Structures analysis

The Parallel Structures kind of analysis goes back to Chomsky (1970), who was responding in part to Lees (1960) and the Generative Semantics movement.³ Chomsky (1970) argued against the idea that noun phrases like *their destruction of the city* were connected to sentences like *They destroyed the city* by a transformation, which derived the former directly from the latter. Instead, Chomsky (1970) argued, the connection between the verbs and nouns was that both projected an XP with a subject position and a complement position.

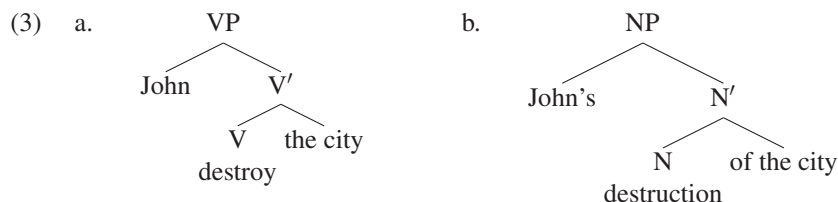

This analysis captured the observation that derived nominals have entirely NP syntax, as opposed to gerunds, which have clear verbal syntax. For example, complements of derived nouns could be PPs or CPs, just like simple nouns, but not accusative DPs. For derived nominals related to verbs that take accusative objects, the nominal version would take

² We will see that the ambiguity problem goes further than just this three-way distinction. For example, Andreou & Lieber (2020, 334–335), in a study of zero-derived (“conversion”) and *-ing*-derived nouns in English, conclude that “the quantificational properties and aspectual interpretation of both conversion and *-ing* nominalizations are not rigidly or even loosely determined by the form of the nominalization, nor by the aspectual properties of the base verb”.

³ See Chomsky (2020) for an overview of the background and his own assessment of consequences of this work.

a PP headed by a pleonastic preposition *of*. In contrast, gerundive nominals take accusative object DPs just like the corresponding verbs do.

- (4) a. John's destruction of the city (Derived Nominal)
 b. John's destroying the city (Gerundive Nominal)

One prominent feature of Chomsky's analysis was that since derived nominals are not derived from sentences or verb phrases, they cannot be fed by transformations that apply to sentences or verb phrases.⁴ Thus, ECM/raising-to-object, raising-to-subject, *tough*-movement, particle shift and double object constructions—all assumed at the time to be derived by a transformational rule applying to clauses/verb phrases—are not possible.⁵ Once again, gerundive nominals allow all of them.

- (5) Derived Nominals
- a. * Mary's appearance to be the best (Raising-to-subject)
 b. * Mary's consideration of Sally to be the best (Raising-to-object/ECM)
 c. * Mary's difficulty to please (*Tough*-movement)
 d. * Mary's looking of the problem up (Particle shift)
 e. * Mary's giving of children (of) gifts (Double object construction)
- (6) Gerundive Nominals
- a. Mary's appearing to be the best (Raising-to-subject)
 b. Mary's considering Sally to be the best (Raising-to-object/ECM)
 c. Mary's being difficult to please (*Tough*-movement)
 d. Mary's looking the problem up (Particle shift)
 e. Mary's giving children gifts (Double object construction)

Derived nominals do not allow auxiliaries such as *be* or *have* or copular *be*, whereas gerundive nominals do.

- (7) a. Mary's being welcomed
 b. Mary's having been there
 c. Mary's being noisy

In derived nominals, arguments were apparently optional, whereas with verbal gerunds, arguments were obligatory to the same extent that they were with verb phrases. Finally, derived nominals could have meanings that were not inherited from the verbs they were related to, and in fact were idiosyncratic and not predictable from them. For example, a *transmission* could refer to a gear box in an automobile, and this might only bear a vague connection to the meaning of the verb *transmit*. In contrast, gerunds always inherit exactly the meaning of the verbs they are derived from. One of the things that makes the study of Icelandic nominalizations particularly interesting is that Icelandic, as we will discuss, does not have anything corresponding to the gerundive nominalization subtype; it only has derived nominals, and they have all the same basic properties listed above for English: they do not allow raising-to-object, raising-to-subject, *tough*-movement, particle shift or the double object construction.

In Chomsky's analysis, all of these properties followed from the claim that derived nominals projected independently as noun phrases, with no clausal or verbal structure in the derivational history, whereas gerunds were derived from verb phrases, so they had all the properties that verb phrases had. Jumping ahead, we will see that Grimshaw's (1990) influential claim was that some of the properties that characterized gerunds, namely inheritance of meaning, and obligatoriness of arguments, also characterized derived nominals when they have a "Complex Event" reading.

Chomsky (1970) is often regarded as the start of the "lexicalist hypothesis", the idea that word formation takes place in a component of grammar (the lexicon) that is separate from the syntax. This is often interpreted as saying that nominalizations are formed in the lexicon because they are too idiosyncratic to be syntactic. However, Marantz (1997) argues that the take home point of Chomsky (1970), viewed from a contemporary theoretical perspective should not

⁴ Some of these empirical claims have been contested for English recently, as we will discuss in section 1.2.2 below.

⁵ Chomsky does not actually discuss the double object construction specifically in this context, but it was later identified as following in the same way (see e.g. Kayne 1981; Abney 1987).

that ‘nominalizations are idiosyncratic, so that they should be handled in the lexicon’. Nominalizations themselves are not idiosyncratic; they are systematic. “What’s idiosyncratic is the relationship between the nominalizations and any ‘sentence’ they might be derived from” (Marantz, 1997, 215). Indeed, Chomsky (2020) writes:

But *application of TG-style devices* [=transformations, JW] to other types of nominalizations [other than gerunds, JW] was highly problematic. *The rules* were complex, varied, unmotivated, often idiosyncratic in form and interpretation. [emphasis added] (Chomsky, 2020, 28)

According to Chomsky’s own current assessment, it is the transformational rules that were too idiosyncratic to be part of the faculty of language when they were used to derive (non-gerundive) nominalizations from verb phrases or sentences.

Updating Chomsky’s (1970) idea to current assumptions in the Minimalist Program (MP) and Distributed Morphology (DM), the idea, according to Marantz (1997) and much subsequent work, is that the lexical root and its argument structure is category-neutral: we derive both the verb and the noun in parallel from the same category-neutral root:

(8) John destroyed the city.

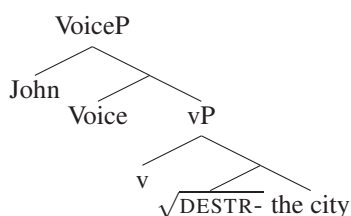

(9) John’s destruction of the city.

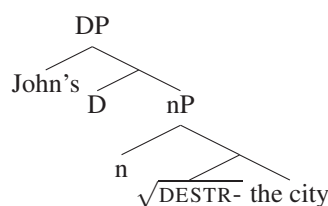

The general idea is that the ambiguity of nouns stems in part from the fact that arguments are obligatory with verbs, but optional with nouns. When arguments are present, their interpretation is the same whether they are in a noun phrase or a verb phrase. When arguments are absent—only possible with nouns—other interpretations of the root are available. As for the morphology, the specific forms are read off of the structure, so that the root $\sqrt{\text{DESTR-}}$ is pronounced as *destroy* in the context of *v*, and as *destruction* in the context of *n*. In the nominal environment, *of*-insertion occurs in order to license or case-mark the complement (something nouns cannot do on their own). Voice or *v* licenses the object in the verbal environment.

There are a number of problems with this general approach. First, nominalizations can contain verbalizing morphology, such as the *-ify* in *solid-ify* and *solid-ifi-cation*. Within DM, this forces the conclusion that there is a verbalizing head in the structure, so at best not all nominalizations can be derived in parallel from a category-neutral root: at least some must be derived from an explicitly verbal base (Alexiadou, 2009; Harley, 2009b). Second, the approach underappreciates the ambiguity: as we will see below, it is not the case that arguments are generally optional with nouns; in the CEN reading, they may be obligatory. Third, the approach fails to derive Borer’s Generalization, mentioned above: there is no reason that the existence of the verbal structure should have any effect on the readings available to the nominal structure (Borer, 2014).

Nevertheless, I will argue below in favor of an approach that adopts certain aspects of the Parallel Structures approach. Essentially, nominals will be derived explicitly from categorized verbs, and this will allow them to inherit eventive meaning and the internal argument. Above that, however, argument structure will be computed in parallel, so that the set of available external argument meanings will be computed in the nominal domain in a manner parallel to how they are computed in the verbal domain. Before turning to this, however, I first turn to the Phrasal Layering analysis.

1.2.2 Phrasal Layering analysis

The Phrasal Layering analysis is an alternative to the Parallel Structures analysis and addresses the shortcomings of the latter. Much of the work stems from the by now classic work of Grimshaw 1990, who argued that in fact, arguments are not optional with nouns. Instead, derived nominals are systematically ambiguous, and come in three distinct readings.

- (10) a. **Complex Event Nominals (CENs)** denote events and take arguments
 b. **Simple Event Nominals (SENs)** denote events and cannot take arguments
 c. **Referring Nominals (RNs)** denote entities and cannot take arguments

A variety of properties cluster together with these classes. For now, I set aside SENs, which I will return to below.

- (11) Some differences between RNs and CENs (Alexiadou & Grimshaw, 2008)

| RNs | CENs |
|---|--|
| a. Non- θ -assigner, No obligatory arguments | θ -assigner, Obligatory arguments |
| b. No event reading | Event reading |
| c. No agent-oriented modifiers | Agent-oriented modifiers |
| d. Subjects are possessives | Subjects are arguments |
| e. <i>by</i> phrases are non-arguments | <i>by</i> phrases are arguments |
| f. No implicit argument control | Implicit argument control |
| g. No aspectual modifiers | Aspectual modifiers |
| h. Modifiers like <i>frequent</i> , <i>constant</i> only with plural | Modifiers like <i>frequent</i> , <i>constant</i> appear with singular |
| i. May be plural | Must be singular |

The idea was that in a given use, a nominal falls under only one of these categories: any mixing of properties leads to ungrammaticality. More specifically, if we add anything that forces a CEN reading, arguments become obligatory. The internal argument must be realized overtly, and the external argument is understood to be present semantically as an implicit argument. The examples in (12)–(13) illustrate this. Without an internal argument *of*-phrase, the agentive modifier *deliberate* (a), the purpose clause (b), the agentive *by*-phrase (c), and the telic aspectual PP (d) are ungrammatical. With the *of*-phrase, they are perfectly acceptable.

- (12) a. * Mary's deliberate collection
 b. * the collection to document the disappearance of mushrooms
 c. * the examination by the teacher
 d. * the destruction in a day
- (13) a. Mary's deliberate collection of illegal data cost her the job
 b. Mary's collection of samples to document the disappearance of mushrooms
 c. the examination of the evidence by the detective
 d. the destruction of the city in a day

I should add immediately that these diagnostics are not as clear cut as some discussions would lead us to expect. Lieber (2017) offers counter-examples to many of them, and other counter-examples are noted elsewhere. For example, some CENs may be plural, modifiers like *frequent* may appear with singular RNs in some cases, RNs may take arguments, etc. I take a critical look at many of these diagnostics in section 2.3. Nevertheless, I maintain in this work, along with much contemporary work, that the distinction is real, and it is the diagnostics that are sometimes imperfect identifiers of the distinction. I note, for example, that to my knowledge, no one has provided convincing counter-examples to the claim that telicity PPs (such as *in a day* in (12)) occur without an internal argument. The sharpness of the contrast between (12d) and (13d) along with the absence of attested, acceptable examples like (12d) supports the conclusion that the distinction between CENs and the other categories is a real one: when truly, unambiguously verbal event structure is present, arguments are obligatory in the noun phrase just like they are in the verb phrase.

Nothing in the Parallel Structures story explains why event structure should correspond to argument realization in this way. In a theory like DM, there should be some account of this correlation between syntax and semantics. Various researchers have thus proposed versions of what I will call the 'Phrasal Layering' analysis (Borer 1997, 2012, 2013, 2014; Roeper & van Hout 1999, 2009; Fu et al. 2001; Alexiadou 2001, 2017b; Roßdeutscher & Kamp 2010; Bruening 2013; Pross 2019; Iordăchioaia 2020b; McGinnis 2020). Alexiadou (2001), for example, proposed that event structure semantics corresponds to verbal structure. To inherit event structure is to attach on top of verbal structure. By attaching

on top of verbal structure, argument structure is inherited, precisely because that verbal structure would have already projected its arguments. A CEN would have a structure like (14) while an RN would have a structure like (15).⁶

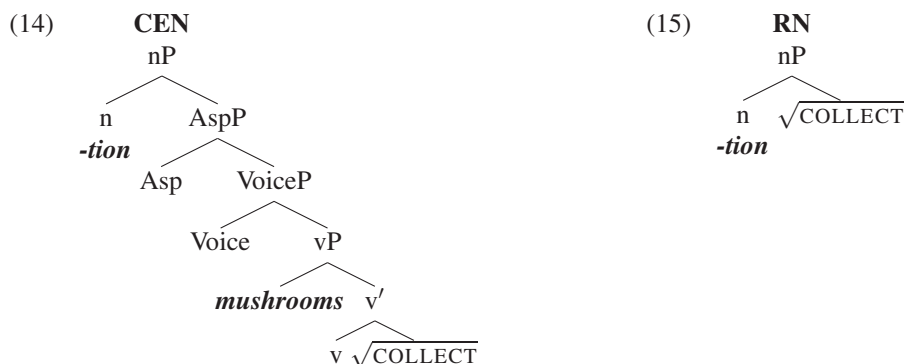

The n head could in principle attach at any level, inheriting more or fewer verbal properties. Alexiadou (2017a) argues that for CENs, n must attach at least as high as vP in order to inherit argument and event structure. When the agent is present, Voice is in the structure as well. Authors vary as to whether they assume that the Voice in nominalizations is active, introducing an argument (possibly null) in its specifier, or passive/unaccusative. Like the Parallel Structures analysis, the object is generally assumed to be licensed by n, which is realized as “genitive of” as the unmarked case (or else *of* is inserted in order to license the object), and the Saxon genitive is licensed/conditioned by D.

In this kind of approach, SENs are generally treated along the same structural lines as RNs, except that they denote events rather than concrete entities. Roy & Soare (2013, 126), for example, present an analysis that distinguishes between “strong/grammatical eventuality and lexical/conceptual eventuality cast in terms of a semantic type difference between entity-denoting vs. event-denoting nominals”. Thus, they are distinct from CENs in that they fail the diagnostics for complex event structure: they do not license agentive *by*-phrases, aspectual modifier PPs, modifiers like *frequent* (when singular), or purpose clauses, but they do pluralize and have an event reading. They are distinct from RNs in the latter, so they pass diagnostics having to do with eventhood:⁷

- (16) a. The *trip/*table* took place at nine o’clock.
 b. The *trip/*table* lasted three hours.
 c. The *trip/*table* has been interrupted.
 d. During the *trip/*table*, ...

Importantly, SENs are not subject to Borer’s Generalization: they exist even when a verb does not (for example, the SEN *trip* is not derived from any verb *trip*), and as discussed in section 1.3.1, SENs, even when derived from verbs, may have idiosyncratic meanings that are not inherited from the verb.⁸

The layering approach solves the problems noted above for the Parallel Structures analysis. First, the presence of verbalizing morphology is unproblematic, since CENs are built on top of full verb phrases.⁹ Second, the ambiguity is derived as a structural ambiguity: arguments are truly obligatory in the CEN reading because to derive that reading, an entire verb phrase—which already has its arguments—is what is nominalized. Third, the approach derives Borer’s

⁶ Note that Alexiadou has made slightly different proposals in different works; (14)–(15) is based on Alexiadou (2017b). Alexiadou (2009), for example, proposes that RNs and SENs both have a v layer, but only CENs have Voice. Alexiadou (2017b) argues that deverbal synthetic compounds have Voice but not Asp, while nominalizations with phrasal arguments have Asp as well; this accounts for differences between the two, such as the fact that synthetic compounds do not license telicity PPs such as *in a day*.

⁷ Some of these may be possible with concrete nouns like *table* if they are coerced to refer to events or the state of existence. The idea here is that SENs do not require such coercion, because they already refer to events.

⁸ As I will discuss further in section 1.3.2.2, these facts underlie the treatment of SENs here, which is largely adopted from or inspired by Roy & Soare’s (2013) approach: the event variable in simple events is type-theoretically distinct from the event variable in complex events. The latter can only be introduced by v. The former is essentially the same as an entity variable in the meta-language, which can point to an event in the model.

⁹ The presence of verbalizing morphology on RNs is still problematic, and it is for this reason that Alexiadou (2009) and Harley (2009b) argued that even RNs may be built on verb phrases. That approach, however, involves the complication that verb phrases may be allowed to have no eventive meaning and take no arguments, just in these cases. Borer (2012, 2013, 2014) avoids this problem by proposing that verbalizing morphology is purely pleonastic, having no direct connection to event structure or argument structure.

Generalization for the same reason: CEN readings are built on verb phrases, so any CEN noun must correspond to an existing, morphologically related verb.

The Phrasal Layering analysis, for all its merits, raises further problems of its own, which will be addressed in some detail in later chapters of this book. One immediate problem that it seems to raise is that there is no natural account of why nominalizations are restricted in the ways that led Chomsky (1970) to propose that they are not derived by transformation in the first place. For example, we would expect raising-to-subject, ECM/raising-to-object, *tough*-movement, particle shift and double object constructions to be able to feed nominalization. Indeed, in an attempt to defend a Phrasal Layering analysis, Bruening (2018b) has argued that, contrary to what is widely assumed, raising and ECM are in fact possible with English nominalizations. I return to Bruening's claim in section 2.3.5, but for now it suffices to reinforce the point that a Phrasal Layering analysis does raise this expectation.¹⁰

An even more serious objection to the Phrasal Layering analysis, in my view, is that there is a sense in which the Phrasal Layering analysis ultimately fails to derive the systematic ambiguity of derived nominals. It emerges as an accident of the fact that Voice, Asp, or even *v* happen to be null in the CEN reading, so that it just so happens that CENs look morphologically like SENs or RNs.

There are phrasal layering approaches that come closer to solving the ambiguity problem in ways that bear some resemblance to the approach taken in this book. Harley (2009b) and Alexiadou (2009), for example, both focus on how the kind of structural contrast shown in (14) and (15) above does not account for the fact that RNs and SENs can have overt verbalizing morphology—so they are not, or at least not always, built by nominalizing an uncategorized root. Alexiadou (2009) similarly proposes that RNs and SENs are (or can be) vP-sized, but maintains that CENs are different in that they may include a Voice and/or Asp head as well (so the ambiguity problem still arises here to the extent that the presence/absence of Voice and Asp does not make an overt morphological distinction).¹¹ Harley (2009b) proposes that RNs, SENs and CENs have the same syntactic structure, much as I do, but that the structure is uniformly phrasal, and includes (or may include) a vP layer. For Harley (2009b), the distinction between RNs/SENs, on the one hand, and CENs, on the other, has to do with the mass/count distinction. CENs are mass nouns, and have an internal argument that delimits/measures out the event. RNs/SENs are derived by a semantic coercion process that turns the mass-noun process meaning into a count-noun result meaning; this coercion process is not possible in the presence of the internal argument. The idea is that RNs/SENs do not have an internal argument, so a determiner can be used to delimit the event/entity, but CENs cannot have such a delimiter because the internal argument already does this, and the same event cannot be delimited twice in two different ways.

One problem with Harley's (2009b) proposal is that the mass/count distinction does not make the right cut between CENs and RNs/SENs; as pointed out by Lieber (2017, 184), there are CENs that are count nouns and RNs that are mass nouns. In fact, as I will discuss in section 2.3.2, CENs can even pluralize when they are count nouns (especially if the event is telic).¹² A more fundamental problem is that the analysis loses the central intuition that motivates a Phrasal Layering analysis. Recall that the idea is that the properties of CENs are what they are *because* they contain vPs, and vPs have these properties. If the analysis turns out to be that vPs do not necessarily have these properties, then the properties of CENs arise from something else—an interaction between verbal semantics and nominalizing layers, for example. But then the Phrasal Layering analysis loses its conceptual motivation—CEN properties are not actually connected to having vP phrasal structure—and is at no advantage compared to the present proposal. In fact, it is at a considerable disadvantage, because it requires some kind of lookahead, for example building vPs with certain structural properties (e.g. the absence of an internal argument) that are only grammatical if they are later embedded under nominalizing heads. The present approach does not have this problem because no verb phrase is built to begin with.

The present approach, which is presented in the next section, does adopt some aspects of the Phrasal Layering approach. Most importantly, I adopt the assumption underlying this approach that the CEN reading stems from a specifically verbal kind of event meaning. Thus, the CEN reading is derived from a verb (though not a verb phrase).

¹⁰ To be clear, I believe that Bruening's (2018b) claims should be treated with some skepticism, especially in the absence of an explanation for why so many examples are clearly unacceptable. Note that among the many potential counterexamples that Lieber (2017) raises to various claims about nominalizations, she finds no examples of ECM, double object constructions, and particle shift. See section 2.3.5 for further discussion.

¹¹ Alexiadou (2009) does not take a clear stand on what licenses the presence or absence of an internal argument, only that verbalizing morphology itself is not enough for this (Alexiadou, 2009, 273). See also McGinnis (2020, 143), who concludes "that the semantic distinction between RNs and CENs arises not from a structural difference, but from a difference in the semantics of the nominalizing head n".

¹² Melloni (2010, 149) points out some empirical problems with Harley's coercion analysis in Italian, and concludes that the analysis "opens and leaves more questions unsolved than it actually answers."

I now present a basic overview of this approach, which will be defended at length throughout the remainder of this book.

1.2.3 Complex Head Analysis

In this book, I argue that nominalizations are systematically ambiguous, but that all three readings should stem from one structure. In particular, I propose that we combine the verbal and nominal heads directly, without their dependents. The basic structure of all readings will be as shown (17).

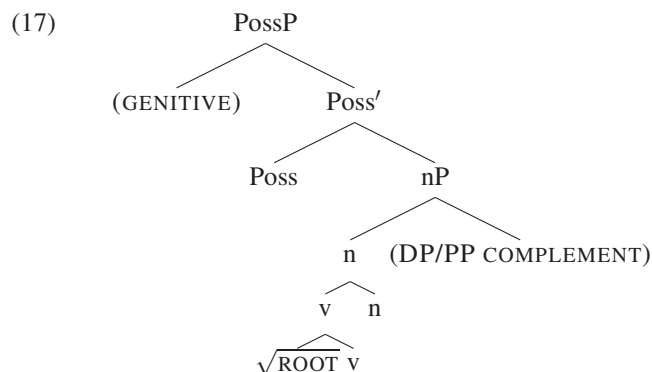

In this structure, what is nominalized is a verb, but there is no verb phrase: the phrasal syntax is entirely nominal.¹³ The absence of certain verbal structures, such as ECM or double object constructions, stems from the range of complements that nouns may take.¹⁴ In chapters 3 and 4, we will see how this structure accounts for the Icelandic-specific problems for the Phrasal Layering kind of analysis.

As for the ambiguity, the basic idea is that the *v* and *n* heads can get different interpretations; when *v* gets its usual meaning (the meaning it gets in the context of a verb phrase) and *n* is an identity function (essentially semantically null), the noun has the exact meaning that a verb would have; event structure and the internal argument meaning is inherited. However, beyond this, argument structure is constructed in a manner similar to what was assumed for the Parallel Structures analysis. In particular, the external argument meaning is not inherited, but it is constructed in the same way that it would be in a verb phrase. *Poss* is parallel to Voice; when an *nP* has the same meaning a *vP* would have, *Poss* may introduce the same meaning (e.g. “agent”) that Voice would have introduced.

However, the presence of *n* may allow for the introduction of meanings that would not otherwise be available. In particular, *v* may be an identity function (semantically null), and then *n* will combine semantically directly with the root. This derives the RN and SEN readings, and the variety of RN and SEN readings will stem from different alloemes of *n* and the interaction of those alloemes with the meaning of the root.

This overall approach has, as far as I know, not been proposed before, so one might wonder why not. I speculate that there are several reasons for this, stemming from the kinds of theoretical assumptions one must make to make the account go through. These assumptions are independently justified, but not uncontroversial, and some have developed quite recently.

First, the account requires that complex heads can be built directly, without first building phrases. It has often been assumed that complex heads are only built through head movement, which, if true, would undermine the present account. However, there is no reason to assume this. If we assume that complex heads are formed by adjunction in head movement, what would require that this operation only applies to elements embedded in a phrase? Even more generally, if adjunction is a phrase-structurally distinct kind of merge, there is no reason it shouldn’t be able to apply

¹³ See also Knittel (2010), who argues for French that the syntax of event nominals is exactly the same as the syntax of non-eventive possessive nominals.

¹⁴ I assume that nouns, here understood as *n*-heads (whether complex or not), take complements (Harðarson 2017). If noun phrase structure turns out to be substantially different in this respect (see e.g. Kayne 2008; Adger 2013; Pfaff 2015), it would require a revision of details of my proposal, but in principle could be compatible with the spirit of my proposal, as long as verbs are nominalized before the introduction of arguments.

to two heads in a workspace. Embick (2004) independently argues that roots may adjoin directly to *v*, without ever occupying a phrasal position.

Second, much previous work in the present tradition has assumed that roots originate in various places in the structure (Hale & Keyser, 1993, 2002; ?; Marantz, 2009a,b, 2013a; Irwin, 2012; Wood, 2012, 2015). The present analysis restricts the possibility quite a bit. While there may be some possibility of putting roots in different places, it would complicate the analysis quite a bit.¹⁵ I will assume that the root always adjoins directly to a categorizing head such as *n* or *v*, and never originates in a phrasal position. This has been proposed quite independently of the current empirical context (Marantz, 2013b), but is not necessarily straightforward or uncontroversial.

Third, the present account requires a departure from the strictest sense of the intuition underlying UTAH, the idea that thematic interpretation is in a one-to-one mapping with syntactic position. The general rigidity of the set of principles surrounding UTAH, D-structure, etc., has driven much previous and current research. Here, however, a thematic interpretation can be introduced in one place and saturated in another, something that Myler (2014, 2016) refers to as ‘Delayed Gratification’. Delayed Gratification isn’t a special process or rule; it is nothing more than allowing UTAH-like effects to stem from the semantic interpretation of heads, and allowing semantic composition to proceed in a fairly straightforward way. Instead of saying that agents must be introduced in SpecVoiceP, we say that agentive semantics are introduced by the Voice head. Such semantics may be saturated by an argument in SpecVoiceP, but need not be (see E.F. Sigurðsson 2017 for extensive discussion of Voice semantics).

Finally, and most crucially, the present account requires systematic late insertion of the semantics of heads like *v* and *n*—what I am calling allosemy. Allosemy of roots has a longer tradition, going back to Arad (2003, 2005), but was only later applied to functional heads like Voice, Appl, *v*, Poss, *p*, etc. (Wood, 2012, 2015, 2016; Marantz, 2013a; Myler, 2014, 2016; Kastner, 2016, 2017; Wood & Marantz, 2017; Nie, submitted; Oseki, submitted). Thus, when Borer (2014) argues forcefully that argument structure cannot be a property of verbs or verbalizers, it is based on the observation that deverbal nouns sometimes have no argument structure. Her argumentation depends on the notion that one syntactic *v* head cannot correspond to several different meanings, the way that one syntactic *v* head can correspond to several different allomorphs (*-ize*, *-ify*, etc.).

Simply put, this collection of assumptions has not been combined in the past, so accounts like the one in this book have not been put forward. But all of the above assumptions are justified. There is no reason that heads cannot adjoin to other heads. It is fully conceivable and reasonable that roots may generally adjoin to categorizing heads rather than originate in different phrase structural positions. The recasting of UTAH-like effects as the consequence of the interpretation of heads and their ordinary semantic composition is independently motivated, as is the assumption that functional heads are subject to allosemy. The resulting overall model of grammar is quite simple: syntax combines primitives into complex structures, and those structures are interpreted in similar ways at PF and LF: they are underspecified, with allomorphy determining the formatives for pronouncing structure and allosemy determining the formatives for interpreting structure. After that, it is phonology and semantics as they are generally understood. Complexity emerges from the interaction of these simple parts, not from the parts themselves.

1.2.4 Beyond the three-way ambiguity

Although it is common, as discussed so far, to assume that there are three basic readings for deverbal nominalizations, it has in fact become clearer that there are more than three readings. There are certainly numerous types of Result/Referring Nominals, and in addition to “Simple Event Nominals” (SENs) there are what might be called “Simple State Nominals”, which have properties that are at least as distinct from SENs as SENs are from RNs. Many of these distinctions, and possible ways of approaching them within the present framework, will be discussed in some detail throughout, especially in chapter 6. In this section, I will preview some of the broad results of this discussion by outlining the basic formal typology of readings that arises most naturally from the system of assumptions developed here and what is known about nominalizations empirically.

The basic system of allosemy makes one initial division into two types of readings, of which various subtypes can be assumed to exist. The two types are

¹⁵ For example, if the root originates in the complement of a verb, the present analysis may entail that the same root will originate in the complement of a noun. But then, the root in the latter case will have to raise to the *n* head, rather than the *v* head, deriving a different constituency from the verb, making potentially distinct predictions for the morphology.

- (a) nominals where *v* is interpreted, and
- (b) nominals where *v* is semantically zero/expletive.

The (a)-type will inherit the meaning of the verb and contain an event variable, whereas the (b)-type will not and may involve an idiosyncratic semantic relationship between the root and the n-head.

In the present proposal, the (a)-type, where *v* is interpreted, derives a CEN when the n-head is semantically expletive. The overall noun has the same meaning that the verb would have had in a verb phrase, but instead exists in the syntactic context of a noun phrase. However, there is another possibility, which is that the n-head is not semantically expletive, but rather carries an interpretation. It still inherits the meaning of the verb, but builds on it (adds something to it) in some way. I argue in chapter 6 that this actually underlies true “result” nominals, where the noun refers to an entity that exists as a result of the event in question. For example, the reading of the word *transmission* that refers to, say, a piece of paper or even the content of a message that was transmitted is derived in this way: the ‘transmission’ is an entity that exists as a result of a transmitting event. This characterization is novel, in that it collapses a distinction made by Melloni (2011) and others within the class of “Result Nominals”, but also cuts across the three way distinction discussed above been CENs, SENs and RNs. But it is an important one, because it makes a distinct prediction regarding the relationship between the root and n head, namely that there should be no direct interaction, and the root should not be able to make an idiosyncratic contribution to the nominal that it does not make to the verb. It also predicts that various word internal modifiers (e.g. prefixes) should be possible only in such cases. If these predictions are correct, it supports the present view that the formal typology of derived nominals should be grounded not in whether they end up referring to an entity, event, abstract state, and so on, but rather in whether the meaning of an *interpreted verb* is contained in (or inherited by) the derived nominal.

The (b)-type, where *v* is not interpreted, derives what were called simple event nominals above, but also what I refer to as simple state and simple event nominals. The idea is that the n-head is independently capable of introducing or referring to concrete entities, abstract states and events. When the v-head is semantically zero/expletive, the n-head can introduce these meanings and the overall result will depend somewhat idiosyncratically on the root. The meaning of the derived form in this case does not necessarily build on or inherit the meaning that the verb would have in a verb phrase, where the v-head is necessarily interpreted. For example, the reading of the word *transmission* that refers to the gearbox in a car is a simple entity reading, not derived from the meaning of the verb *transmit*.

State meanings of deverbal nominals come in at least two kinds. The first is a result state, which is the sort that is discussed by Hidalgo & García (2012), Roßdeutscher & Kamp (2010) and Pross (2019), among others. It can be diagnosed in several ways. Modifiers like *brief* pick out the result state meaning in phrases like *the brief weakening of the organism*, which refers to the period of time that the result state held. Other diagnostics used include predicates such as *persists unchanged* and *is still valid*, and *simple*, as well as verbs like *documented/recorded X with a photo*. In chapter 6, I will suggest that result states are just results that happen to be states, and remain agnostic as to whether their “statehood” needs to be explicitly specified in the semantics. The second kind of state is what I refer to as a simple state, which can occur in the phrase *in a state of X*. This is most frequent with deadjectival nouns and simple nouns like *anxiety*, *shock*, *readiness*, *exhilaration*, *emergency*, but can also occur with deverbal nouns like *decomposition* and *confusion*. Note that simple states may be the result of a previous event, but need not be. (One could, for example, be born and live one’s entire life in a state of confusion without ever having undergone an event leading to this state.)

The basic typology is schematized in (18).

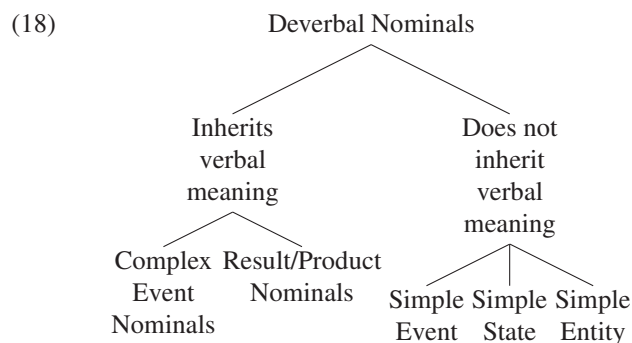

However, I would like to emphasize that the terminal nodes in this schema are in a way less central to the overall proposal, as they have to do with the exact content of the semantic denotations of derived nominals that goes beyond

the present proposal, is strictly independent of the present proposal, and arises in some form for any proposal. For example, I propose in chapter 6 that events and states are subtypes of entities in the model. I encode the property of being an event or state as an additional statement about an entity as part of the denotation of (an alloset of) the n-head. Essentially, it says “this is an entity and also it is a state”.¹⁶ However, it is also possible there are no such additional statement in the denotation, and all three subtypes—Simple Events, States, and Entities—are all just simple entities, with root semantics determining the distinction. There are also possibly more distinctions. I also discuss in chapter 6 the question of whether abstract entities and concrete entities ought to be distinguished in this way. In this case, the discussion is inconclusive (although I do propose that there is an alloset of n that refers specifically to location).

As mentioned in section 1.2.2 above, the previous approaches to the ambiguity problem of nominalizations that are in important respects the most similar to the present one are Harley (2009b) and Alexiadou (2009), since both acknowledge that RNs and SENs may contain something at least the size of the verb; for them, in fact, it is a verb phrase. However, the distinction between inheritance and non-inheritance of verbal meaning is central to the present proposal, and distinct from both Harley (2009b) and Alexiadou (2009). Harley’s proposal does not distinguish between the inheritance or non-inheritance of verbal meaning at all, or connect that to the (non-)availability of idiosyncratic meaning. For her, a vP-sized structure may freely take an internal argument or not, although in some cases, not taking an internal argument will result in ungrammaticality unless the vP is nominalized. This vP-sized structure may take an idiosyncratic meaning or not, whether or not it takes an internal argument. In Harley’s proposal, there is nothing in the structure that would prevent the *-væðing* nouns discussed in Wood & Soares (2021) and section 6.5 below from getting idiosyncratic meanings: they can form RNs, so they should be able to be idiosyncratic semantically, which is contrary to the actual empirical situation.

Alexiadou (2009), on the other hand, proposes that vP-sized RNs always inherit verbal meaning, making a distinction much like the one I make here. However, as I discuss in various places throughout this book (see especially chapter 6), however, there are reasons to think that even when a v-head is present, a nominalization can be idiosyncratic in meaning, so the presence of a v-head alone is not enough. First, it has been well documented that there are cases where a v-head is present in the context of a deverbal adjective with idiosyncratic meaning (Anagnostopoulou & Samioti 2013; Marantz 2013a). Marantz (2013a) proposes that in these cases, it is a non-phasal participial head outside of v, but lower than the categorizing little a head, that conditions the special meaning. Second, we see cases where the morphological realization of n seems to be sensitive to the root past a little v head. For example, the noun *payment* may have a CEN reading, which I take to mean that there is a (morphologically zero) little v head, at least in the CEN cases. But since *-ment* is not an outer, “elsewhere” morpheme, it must be sensitive to the identity of the root, past the v head. Similarly, the noun *destruction* may have a CEN reading, indicating that there is a v-head. Nevertheless, the presence of the n head realized as *-tion* leads to an idiosyncratic pronunciation of the stem as *destruct-* rather than *destroy*. Arguably, if the root can affect the pronunciation of n, and n can affect the pronunciation of the root, then a parallel interaction should be possible in the semantics as well. Third, there are cases with overt little v heads that arguably have idiosyncratic meaning, such as *civilization*, which potentially confirm this expectation. This is discussed in far more detail in chapter 6. Alexiadou’s proposal would correctly rule out special meaning of the *-væðing* nouns, since the *-væða* morphology indicates a v-layer, but it does so in a way that incorrectly rules out these other cases.

1.2.5 Why Icelandic nominalizations?

Icelandic nominalizations have been the subject of much less research than nominalizations in many other languages, and much less than other phenomena in Icelandic.¹⁷ One reason for this may be that Icelandic nominalizations are in a sense less productive than nominalizations found in other languages. The language has nothing like *-ing* gerunds or

¹⁶ The way this is conceived of here has to do with the relationship between the metalanguage and the model. I assume that states and events are types of entities in the model. In the type-theoretic meta-language, variables of type s, which are introduced by verbs, pick out only entities that are events. Variables of type e, on the other hand, may in principle pick out any entity, whether it is a state, event, concrete entity, abstract entity, etc. So any event that a variable of type s can point to a variable of type e can point to as well, but not vice-versa. The denotation of a simple event points to a set of entities of type e which are equal to (co-extensive with) an eventuality of type s.

¹⁷ Some theoretically-grounded work that focuses or at least touches in a meaningful way on Icelandic nominalizations (including compounding) include Indriðason (1999), Maling (2001), Bjarnadóttir (2005), Ingason & E.F. Sigurðsson (2015), Ingason (2016), and Harðarson (2017, 2018), but the study with the most detail in connection with the present work is Jóhannsdóttir (1995).

-ing of nominals in English, or *-ung* nominals in German. Its nominalization system in fact resembles, in some ways, what English would look like if English lacked *-ing* completely, and was forced to use only *-ation*, *-ment*, *-al*, etc. This raises the question of why Icelandic in particular is theoretically interesting? Wouldn't we be able to draw more general and penetrating conclusions about language broadly speaking by focusing on languages with fully productive nominalization systems?¹⁸

In fact, there are a few reasons why Icelandic nominalizations are of substantial interest to a general theory of language. Firstly, its case system allows us to ask questions which cannot be answered in the same way with other languages. In particular, the existence of dative themes that can correspond to genitives in nominalizations makes it unlike German, and provides an important argument in favor of the proposal to derive complex event nominals without building any verb phrase. The arguments in chapter 3 more generally stem not from something special about Icelandic nominalization, but from specific properties of Icelandic grammar in general that cannot be tested in other languages.

Secondly, the fact that Icelandic builds Complex Event Nominals in the way that it does directly bears on the argumentation surrounding nominalization more generally. Strong claims have been made about how argument structure inheritance works from layering perspective. Consider the following quote from Borer:

“... argument structure and arguments, both internal and external [...] emerge from the presence of [...] functional projections which are associated with the verbal extended projection.”

(Borer, 2014, 75)

Her claim is that argument structure itself must come not from a verb, but from a verb phrase. Inheritance of argument structure therefore must come from nominalizing verb *phrases*, not verbs. This is not just her perspective: the general idea behind Phrasal Layering analyses is that argument structure inheritance looks the way it does *because* what is being nominalized is—and in fact, must be—a verb phrase that already has its arguments.

Now, it is possible that phrasal layering patterns do exist, where a single affix can attach “high” and form a gerund, but also “low” and form a Result/Referring Noun. A clear case illustrating this is at least some examples of English *-ing*:

- (19) a. Her timing the race (bothered her rivals)
b. It is important to have good timing.

The *-ing* in (19a) clearly involves a construction, the verbal gerund, which contains a full verb phrase, and this is arguably derived by attaching *-ing* above that phrase. The *-ing* in (19b), however, derives an idiosyncratic interpretation of *timing* that is characteristic of low attachment. If we assume that the two instances of *-ing* are in some sense the ‘same’ (e.g. both realizing the same functional element), then this is an example of a phrasal layering pattern. Citing Engelhardt (2000) (on Hebrew), Harley (2009b) points out that some languages do show major morphological differences between event and result nominals, which also suggests that layering patterns exist.

Moreover, I should be clear that verb phrase nominalization in general clearly does seem to exist. The discussion of Lithuanian in section 3.1.6 of chapter 3 shows that not only does verb phrase nominalization exist in that language, but it has exactly the properties we would expect it to have. And of course, if a verb phrase is nominalized, then its event structure and argument structure will be inherited by—more precisely *contained in*—the derived nominal structure. So my claim in this book is not that the complex heads analysis is the only way to derive a CEN, nor is my claim that CEN/RN ambiguity can never stem from syntactic ambiguity.

Rather, my claim is that Phrasal Layering is not the only way to build CENs, inherit arguments, and so on. Icelandic shows that there must then be some other way of deriving argument structure inheritance and the systematic ambiguity of derived nominals. But if there is some other way, then we should be led to reconsider many other cases, especially those nominals with a CEN/RN ambiguity: showing that a form passes CEN diagnostics is not enough to show that it involves a verb phrase. After all, if allosemy of functional heads is a property of human languages, it seems to me almost certain that all languages will have some instances of it. If we further assume, as seems reasonable at least as a null hypothesis, that the expletive/zero interpretation of category-determining heads is generally available and not specially learned, then it seems likely that complex heads structure is behind many instances of derivation cross-linguistically (not just deverbal nominalization), particularly for forms which are systematically ambiguous without

¹⁸ It is worth pointing out, however, that Icelandic still does have a very robust system of nominalizations, with many nominalizing affixes building the same kinds of nominals. When we abstract away from particular affixes, the extent to which it is less productive mainly has to do with the fact that the relationship between particular verbs and their nominalized forms is somewhat unpredictable, along with the fact that some verbs seem to allow no event nominals to be derived from them at all.

any visible morphological distinction correlating with the ambiguity. Whether this analysis is cross-linguistically ubiquitous (as I suspect) or not, the point in this work is that it exists, and our theory of language in general must allow for that.

1.3 Proposal

1.3.1 (Contextual) Allosemy

In this section, I first show how allosemy works, deriving the three basic readings of a derived nominal (all while staying at the level of the complex head). Essentially, the *v* and *n* heads can get different interpretations (suppletive allosemes), and crucially for our purposes, either the *v* head or the *n* head can be “semantically \emptyset ” (a type-neutral identity function). The former case derives referring nominals and simple event nominals, while the latter case derives complex event nominals.¹⁹

I now turn to the ambiguity of nominalizations, and show how it can be derived from a single structure. First, consider the general ambiguity problem: the alternation between these three readings (CEN, SEN, RN) is systematic across a range of affixes.

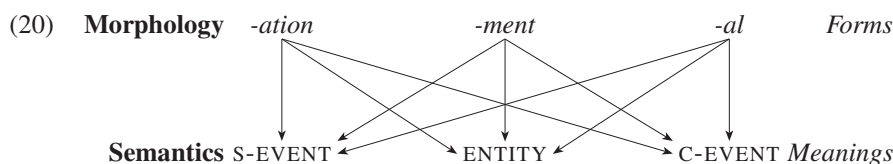

Typically, work in DM assumes that the mapping to morphology is one-to-many, but the mapping to semantics is determined by flavors of meaning, e.g. subcategories of *v*, *n*, *a*, etc. However, this view only gets us part of the way: it explains why any given meaning has multiple affixes, but it doesn't explain why the same meanings get the same set of affixes.²⁰

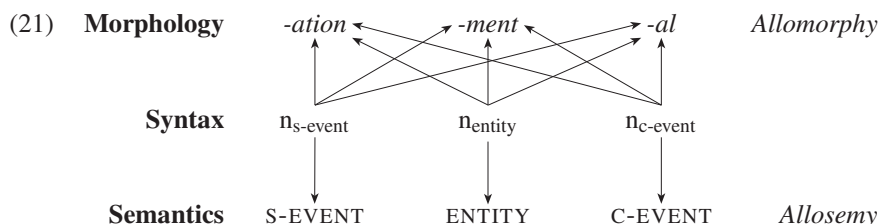

The proposal I defend in this work (and elsewhere) is that we extend late insertion to the semantic side, where the denotations of functional heads like *v*, *n*, Voice, Appl, etc., are determined post-syntactically. I refer to this as allosemy, which is treated essentially along the lines of suppletive allomorphy. When the syntactic or semantic context restricts the available set of allosemes, this is contextual allosemy (again, like contextual allomorphy). I will discuss cases of contextual allosemy in some detail in chapters 5 and 6.

¹⁹ As we will see in later chapters, some RN readings can arise when both *v* and *n* get a non-null interpretation.

²⁰ This is only a schematic representation, not any one specific proposal. This kind of reasoning has been applied most frequently to verbs; see Harley (2009b) for a discussion of the many-to-many mapping between flavors of *v* and overt realizations of *v*.

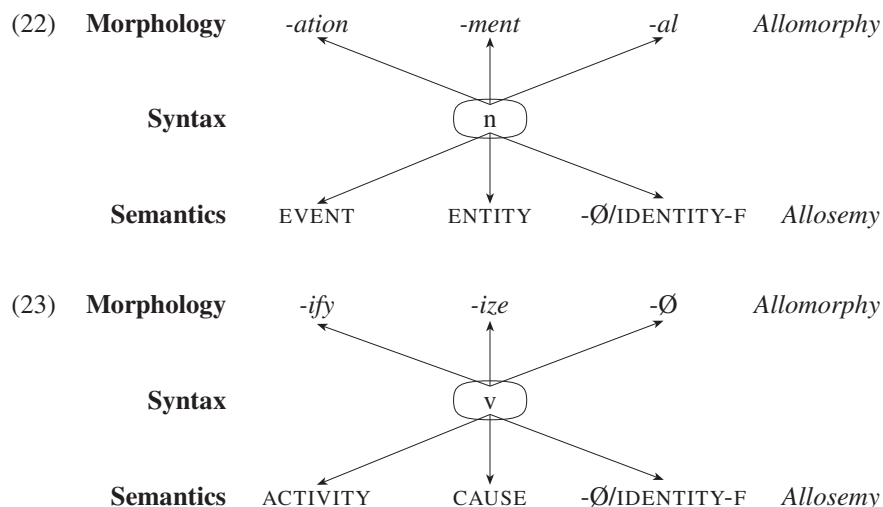

What is crucial to the analysis of nominalizations is that either *n* or *v* can be semantically \emptyset (technically, a type-neutral identity function).²¹ The morphology, however, is insensitive to the choice made at semantics, and vice-versa. This is how the systematic ambiguity is built and derived by the system with the complex heads analysis.

Before elaborating on the structure and interpretation of nominalizations, it may be useful to show how the interpretation of Voice is established in this system. I assume that the Voice head that takes the *vP* as its complement has a number of distinct allosemes, some of which are shown in (24).

- (24) a. Voice $\leftrightarrow \lambda x_e \lambda e_s. \text{AGENT}(x,e) / _$ (agentive *vP*)
 b. Voice $\leftrightarrow \lambda x_e \lambda s_s. \text{HOLDER}(x,s) / _$ (stative *vP*)
 { . . . other meanings in other contexts. . . }
 c. Voice $\leftrightarrow \lambda P_{\langle s,t \rangle}. P$ / $_$ elsewhere

Note that in addition to the agent and state-holder interpretations, (24c) is an expletive interpretation that is used in anticausatives with no semantic external argument. In Wood (2016), I argued that lexical roots themselves generally do not directly determine whether Voice gets the agentive alloseme or not, even if it may seem that way. Usually, the verb *myrða* ‘murder’ seems to be a verb that requires agentive Voice, so it must be transitive, as in (25a), and cannot form an *-st* anticausative, as shown in (25b). In contrast, *blómga(st)* ‘bloom’ seems to be a verb that resists agentive voice, so it must form an *-st* anticausative as in (26b), and cannot be transitive, as shown in (26a).

- (25) a. Konan myrti manninn.
 woman.the.NOM murdered man.the.ACC
 ‘The woman murdered the man.’
 b. *Maðurinn myrti(-st).
 man.the.NOM murdered-ST (Wood, 2016, 18)
- (26) a. *Garðyrkjumaðurinn hefur blómgað seljuna.
 gardener.the.NOM has bloomed sallow.the.ACC (Wood, 2015, 162)
 b. Seljan hefur blómga-st.
 sallow.the.NOM has bloomed-ST
 ‘The sallow has bloomed.’ (Wood, 2016, 17)

²¹ Semantically \emptyset *v* was proposed for certain Greek participles by Anagnostopoulou & Samioti (2009, 2014) and Anagnostopoulou (2012), although they treated it as a separate category *v_C*, distinct from eventive *v_E*, and not as allosemy. Marantz (2013a), Myler (2014, 2016) and Wood & Marantz (2017) propose a semantically \emptyset *v* as allosemy. For allosemy of other heads, such as Voice, Appl, *p*, etc., see Wood (2012, 2015, 2016); Marantz (2013a); Myler (2014, 2016); Wood & Marantz (2017); Kastner (2016, 2017); Nie (submitted) and Oseki (submitted). For related ideas, see Ingason & E.F. Sigurðsson (2015).

However, this only necessarily holds when the roots have their canonical interpretations. Thus, when *myrða* ‘murder’ gets a non-canonical (metaphorical) interpretation, some speakers allow an anticausative structure, as in the attested example in (27a). Conversely, when *blómga(st)* ‘bloom’ gets a non-canonical (metaphorical) interpretation, some speakers allow an agentive transitive structure, as in the attested example in (27b).

- (27) a. flashið var svo sterkt að ég var að myrða-st í augunum
flash.the was so strong that I was to murder-ST in eyes.the
‘The flash was so strong that my eyes were killing (“murdering”) me.’²² (Wood, 2015, 163)
- b. [...] með það að markmiði að blómga gamla hafnarsvæðið.
[...] with it as goal to bloom old harbor.area.ACC
‘... with the goal of blooming the old harbor area.’²³ (Wood, 2016, 20)

Thus, it is not a feature of the morphosyntactic root that determines which alloseme in (24) that Voice received. Rather, it is a property of the overall interpretation of the verb phrase that does so. Broadly, I outlined this process in Wood (2016) as in (28).

- (28) a. **Step 1:** Build the vP.
b. **Step 2:** Merge VoiceP layer.
c. **Step 3:** Spellout vP (assign its terminals a phonological and a semantic interpretation).
i. **Step 3.1** Determine the “structural semantics” (“COS event”).²⁴
ii. **Step 3.2** Determine the set of root allosemes available.
iii. **Step 3.3** Choose the root alloseme based on 3.1 and 3.2.
d. **Step 4:** Choose the appropriate alloseme of Voice, given the overall meaning computed in Step 3.

Normally, *myrða* ‘murder’ plus a sentient internal argument will result in a vP with a meaning that requires an agentive alloseme of Voice. But when *myrða* ‘murder’ takes a metaphorical meaning instead (e.g. ‘extreme eye pain’), it is compatible with the expletive alloseme used in anticausatives. When *blómga(st)* ‘bloom’ combines with an internal argument denoting a plant that grows and sprouts flowers, it will form a vP that denotes an “internally caused” event, which is not compatible with an agentive alloseme of Voice. However, when *blómga(st)* ‘bloom’ combines with an internal argument that does not denote a plant, such as ‘harbor area’, it gets a metaphorical reading and forms a vP that denotes an event which is compatible with the agentive alloseme of Voice.

Previewing what is ahead, the basic structure of an event nominalization defended here is (29).

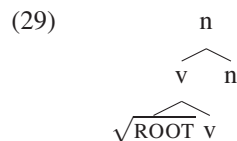

Schematically, three ways of interpreting the v and n heads in this structure yield the three basic readings of event nominals (CEN, SEN and RN).

(30) CEN Reading

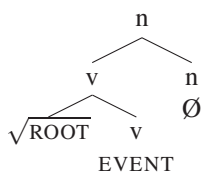

(31) SEN Reading

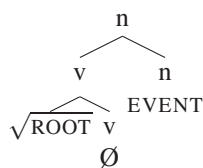

(32) RN Reading

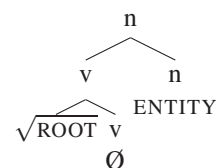

²² <http://angels2.blogcentral.is/sida/2276603/>, retrieved April 2009

²³ <http://frettatiminn.is/blomstrandi-svaedi-vexti/>, retrieved Dec. 2016

²⁴ See chapter 5 for a detailed analysis of how the semantics of change-of-state vPs are read off of the tree.

The discussion of Voice allosemy above provides us with a way of understanding how apparent argument structure inheritance in CENs works. The determination of an external-argument introducing head's allosemy is based on the holistic interpretation of the verb phrase. Notice first that the CEN reading is derived when *v* is interpreted as an ordinary verb (i.e., as it would be interpreted in a *vP*) and *n* is interpreted as \emptyset . This means that the derived noun means the same thing as the verb. Therefore, they form noun phrases that have the same interpretation that the corresponding verb phrase would have. The external-argument-introducing head within the extended *nP*—namely *Poss*—can then take on the exact same allosemy that a Voice head would have taken. I elaborate on this analysis in detail in chapter 5.

However, given the existence of semantically \emptyset *v*, there is another way to interpret this structure: *v* can be semantically \emptyset , and *n* gets a contentful interpretation. This contentful interpretation can refer to a concrete object or an event.²⁵ One might wonder, at this point, why I am attributing the eventive meaning of the SEN reading to *n* rather than *v*. First of all, it is worth remembering that we already know that nouns can introduce eventive meaning: simple, non-derived nouns like *trip* or *party* are examples of this. So there is nothing that should restrict the system from making use of these denotations in the case of deverbal nouns with a \emptyset *v* head. Second, and more importantly, the SEN readings of derived nouns do not necessarily correspond to existing verbal meanings, in stark contrast to the CEN readings. Consider the sentences in (33). As mentioned earlier, for many speakers, myself included, *examine* in (33a) cannot mean 'administered an exam to the students', the way the verb *test* can. It can only mean that the subject inspected the students closely, such as looking at them with a magnifying glass. The CEN reading of *examination*, shown in (33b), inherits this meaning; the underived event noun *test* cannot form a CEN. However, the SEN reading of *examination*, shown in (33c), can easily refer to the event of students (or someone) taking an exam, just like the underived event noun *test*.

- (33) a. They { tested / # examined } the students.
 b. their { *test / # examination } of the students CEN
 c. The { test / examination } lasted all day. SEN

This suggests that the SEN reading is not derived from the verbal reading, but instead stems from the general fact that *n* is able to introduce an eventive meaning. The relationship between the noun *test* and the verb *test* is that the same root can adjoin to either a *v* or *n* head. When the verb *test* adjoins to an *n* head, that head is pronounced as *-ing*.

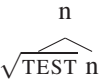
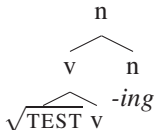
- (34) a.  b.  c. 

The root-derived noun in (34b) has an eventive meaning, as shown in (33c). No verb or *v* head is needed for this meaning; the *n* head itself can introduce the eventive meaning—but it is the SEN reading, not the CEN reading, as shown in (33b). The noun *examination* is derived from a verb, but uses the same basic *n* head meaning in (33c); the structure and meaning is what is illustrated in (31). The CEN reading, on the other hand, stems specifically from the kind of eventive meaning introduced by the *v* head, and this meaning is inherited by the noun when the *n* head is semantically null, as in (30). As we will see below, I will follow Roy & Soare (2013) in assuming that the SEN reading involves not an event variable of type *s*, but rather a subtype of entity, of type *e*. Root interpretation can be sensitive to this distinction.

This overall approach derives the two related, but distinct generalizations about the ambiguity mentioned above and repeated here.²⁶

²⁵ There is a fourth option, which is that both *v* and *n* get a contentful interpretation; see discussion in chapter 6.

²⁶ As mention above, I attribute these generalizations to Borer and Lieber, not because they are the first to notice them, but because of the prominent role the generalizations play in their theoretical work. Borer (2003, 47) says that Grimshaw (1990) mentions (what I am calling) Borer's Generalization, and attributes it to a personal communication from A. Zucchi, but "does not pursue its consequences" (Borer, 2003, 47). Melloni (2010, 162) discusses Borer's Generalization in a different context. Discussing the polysemy patterns of simple, underived nominals as compared to nominals derived from verbs, she generally emphasizes that the patterns of the two kinds of nouns are the same. However, she points out that only deverbal nominals have complex event structure. Her observations fit the proposal in this work in that when *v* is semantically null, the relationship between *n* and the root can be idiosyncratic, just like when the root is attached syntactically directly to *n*.

- (35) a. **Borer’s Generalization:** Complex Event Nominals are always built off of an existing verb with the same meaning (Borer, 2003, 2014).
- b. **Lieber’s Generalization:** Every nominalizing affix that has an eventive meaning also has one or more referential meanings (Lieber, 2017).

Borer’s Generalization follows because CEN meaning is built off of the existing verb; if the meaning is available in a nominal context, it will be available in a verbal complex. Lieber’s Generalization follows because once (29) is the structure of a CEN (so an eventive meaning is available), there is nothing to stop that same structure from getting the SEN or RN reading. Since the morphological realization happens “out of view” of the semantics, the distinction between, say, *-ment* and *-ation* is not sensitive to the alloemes chosen for v or n.²⁷ It does not mean that every root will allow the SEN or RN reading—rules of contextual allosemy and semantic compatibility will limit the availability of the three readings with specific roots. But since the structure in (29) can be interpreted as an SEN or RN, any nominalizing affixes that realize the n head of a CEN will be available for SEN/RN readings as well.

1.3.2 *The syntax-semantics interface*

The model of the grammar adopted and developed in this book assumes that there are a number of steps required to map a syntactic structure to a semantic representation, and several of these steps are similar to how that same structure is mapped to a morphophonological representation. First, there is Vocabulary Insertion for suppletive allosemy, as described above. This step involves mapping terminal nodes in the syntax to typed semantic functions, represented with lambda operators and variables. Second, there are rules of coercion and typeshifting, which modify existing semantic representations to fit their contexts. Third, there are basic rules of composition, allowing semantic formulas to combine with other semantic formulas, including Functional Application, Function Composition, Predicate Conjunction, Event Identification, etc. There are also, as we will see, certain kinds of “default” rules, such as a rule that interprets the juxtaposition of an event and a state as causation. This is discussed more explicitly in chapter 5.

1.3.2.1 *Zeros and pruning*

There are many examples of allosemy, here and elsewhere, that involve inserting semantic zeros into functional heads. This is often described as being the same as inserting a type-neutral identity function. For most cases I am aware of, treating semantic zeros in this way is perfectly fine. However, in the literature on morphology, it has been noted that morphological zeros are often more than simply morphemes that happen to have no phonological features. Instead, they can have a bearing on allomorph selection and phonological processes which suggests that it matters that they are not just zero, but actually not there. Embick (2010) explicitly proposed that zeros are pruned from the structure, so that if there is a morpheme sequence consisting of X-Y-Z, and Y is \emptyset , then it will be removed from the structure entirely, and X will attach directly to Z.

In some of what follows, it will make a crucial difference that we assume that semantic zeros are pruned from the structure as well. As I will argue in detail below, a Complex Event Noun (CEN) has an interpretation where the n head and the P head of its PP complement are both interpreted as semantically zero. If we assume pruning takes place at this point, the node interpreted as zero will be deleted, and the semantics will proceed as if it is not there.

²⁷ I am sometimes asked how this kind of model should be understood in terms of parsing, comprehension, production, etc. The present theory is not a theory of these things. However, a reasonable way to interpret parsing and comprehension would be that the hearer uses the phonetic input to parse a phonological and morphosyntactic structure, and that structure serves as the input to semantic interpretation. The idea here would be that once the phonetic signal is used to infer a syntactic structure, the phonemic and morphemic information that led to that inference is no longer needed, and so it is discarded.

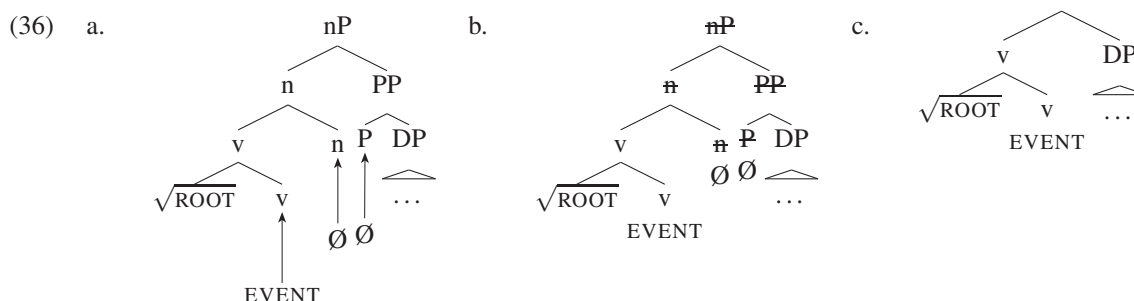

Similarly, I will propose that RNs (and SENs) have an interpretation where the *v* head is semantically zero. If we assume pruning, then this means that the *v* head is deleted and the *n* combines with the root directly.

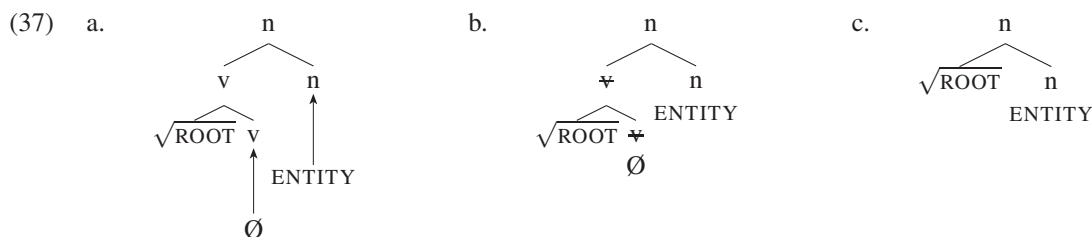

Much of the time, it may not matter whether one assumes pruning or not. However, where it seems to matter in the present study has to do especially with the interpretation of roots. For example, it will be important that for the SEN and RN readings, there is no event variable at the level of *v*. However, in some cases, the root will need to introduce an event variable at the *n* level, in order to be integrated semantically. However, if we assumed that *n* triggers the root to introduce its event variable, than without pruning, the *v* will have this event variable too. Semantically, then, it is important that the zeros are pruned. Then by the time the root is triggered to introduce a variable, it will be combining directly with *n* and *v* will be out of the picture.

1.3.2.2 Semantic types

I assume a basic type-theoretic system of semantic composition, with the following basic types, along with the variables I typically use to express them (which I will keep fairly consistent for expositional clarity).

(38)

| Type | Abbreviation | Typical variables |
|-------------|----------------------|-------------------|
| Entity | <i>e</i> | <i>x, y, z</i> |
| Event | <i>s_e</i> | <i>e, e', e''</i> |
| State | <i>s_s</i> | <i>s, s', s''</i> |
| Truth value | <i>t</i> | — |

In addition, I assume that functions are also types, and I use a capital *P* to indicate such functions, subscripted with abbreviations to indicate what the function is. So, for example, $P_{\langle s_e, t \rangle}$ is a function from events to truth values. Note that I do not, in this work, make use of degree variables, time variables, or other kinds of variables; I assume that these are all in principle compatible with the claims made here.²⁸

²⁸ In fact, I hope to make it clear throughout that the primary contribution of this work is not connected with the specifics of the semantic formulas themselves, but on the relationship between these formulas—whatever they happen to be—and the syntactic structure. I can imagine numerous ways of altering the semantics, or the assumptions about what the model and/or typing system is like, that would be fully compatible with the core claims of this work. (For example, one could attempt to fit a DRT model of event semantics along the lines of Roßdeutscher & Kamp (2010) or Pross (2019) to the present claims about syntactic structure and allosemy, although those specific proposals as they stand are not compatible with the syntactic structure proposed here.) The idea is to give something precise enough to show how the system works, especially with respect to allosemy and syntax. Certain claims, like the idea that some nodes have “semantically zero” allosemes, are central to the present proposal. I will try to make it clear throughout what is central to the proposal, and what is adopted for the purposes of precision, convenience and simplicity.

It is worth explicitly pointing out that I assume that there is a distinction between the type-system in the meta-language and the objects that variables can point to in the model. For example, I assume that events and states are both subtypes of eventualities, and that an eventuality is a subtype of entity. Entities can be concrete or abstract, and objects of type e can point to events, concrete objects, states, etc. Therefore, an object of type e or an object of type s_e could in principle point to the same event in the model. However, compositionally, it is possible for a function to require something of type s_e ; in such cases, anything in the formula that is type e , even if it happens to point to an event in the model, will not be a possible input for that function.

Importantly, I assume that semantic formulas can contain an identity relation that associates variables of different types. For example, Pyllkkänen (2008) argues that external argument causers are related to implicit causing events by such a relation. Consider her analysis of a Japanese lexical causative like (39a), as shown in (39b).²⁹

- (39) a. *Sensoo-ga Taroo-o sin-ase-ta.*
 war-NOM Taro-ACC die-CAUS-PST
 ‘The war caused Taro to die.’
- b.
- VoiceP
 $\lambda e \exists e'$.
 dying(e')
 & theme(e' , Taro)
 & CAUSE(e, e')
 & $e = \text{the war}$

DP Voice'

the war $\lambda x \lambda e \exists e'$.
 dying(e')
 & theme(e' , Taro)
 & CAUSE(e, e')
 & $e = x$

Voice vP

$\lambda x \lambda e. e = x$ $\lambda e \exists e'$.
 dying(e')
 & theme(e' , Taro)
 & CAUSE(e, e')

cause die Taro

Here, the cause relation exists inside the vP as a relation between two event variables of type s : e and e' . Voice introduces an identity relation, specifying the causing event, by pointing to the entity x (of type e) that is identical to the causing event e (of type s_e). By assumption, the denotation of the DP ‘the war’ could not saturate the event variable directly, since it is of a different type. However, it can saturate an entity variable that is specified as identical to the event variable in the model. This is the sense in which the compositional system strictly respects the formal typing, even when different types can point to the same object in the model.

1.3.2.3 Composition rules

I am assuming a fairly simple set of composition rules, which include Functional Application, along with several kinds of conjunction rules. Among the conjunction rules, I distinguish what I refer to as Predicate Conjunction, which applies when two nodes have the same semantic type, and “Identification” rules, which identify a subset of variables in the range of two nodes. First, I assume the definition of Functional Application in Heim & Kratzer (1998, 44).

²⁹ Here I replace her “CauseP” with vP, and gloss over the internal structure of that vP.

(40) **Functional Application**

If α is a branching node, $\{\beta, \gamma\}$ the set of α 's daughters, and $\llbracket \beta \rrbracket$ is a function whose domain contains $\llbracket \gamma \rrbracket$, then $\llbracket \alpha \rrbracket = \llbracket \beta \rrbracket(\llbracket \gamma \rrbracket)$.

Second, I assume a generalized kind of Predicate Conjunction as in (41) (see Wood 2015, 23).

(41) **Predicate Conjunction**

If α is a branching node, $\{\beta, \gamma\}$ is the set of α 's daughters, and $\llbracket \beta \rrbracket$ and $\llbracket \gamma \rrbracket$ are both in D_f , f a semantic type which takes n arguments, then $\llbracket \alpha \rrbracket = \lambda(a_1, \dots, a_n). \llbracket \beta \rrbracket(a_1, \dots, a_n) \wedge \llbracket \gamma \rrbracket(a_1, \dots, a_n)$.

Finally, I assume two kind of identification rules.

(42) **X Identification 1**

If α is a branching node, $\{\beta, \gamma\}$ is the set of α 's daughters, where $\llbracket \beta \rrbracket$ is in $D_{\langle a, \langle b, t \rangle \rangle}$ and $\llbracket \gamma \rrbracket$ is in $D_{\langle b, t \rangle}$ (where a and b are variables for semantic types), then $\llbracket \alpha \rrbracket = \lambda a_a \lambda b_b. \llbracket \beta \rrbracket(a)(b) \wedge \llbracket \gamma \rrbracket(b)$.

(43) **X Identification 2**

If α is a branching node, $\{\beta, \gamma\}$ is the set of α 's daughters, where $\llbracket \beta \rrbracket$ is in $D_{\langle a, \langle b, t \rangle \rangle}$ and $\llbracket \gamma \rrbracket$ is in $D_{\langle a, t \rangle}$ (where a and b are variables for semantic types), then $\llbracket \alpha \rrbracket = \lambda a_a \lambda b_b. \llbracket \beta \rrbracket(a)(b) \wedge \llbracket \gamma \rrbracket(a)$.

These identification rules will cover classic ‘‘Event Identification’’, but are not restricted to events and individuals in a specific order. Essentially the idea is that when two nodes are combining semantically, they may conjoin the shared parts of their functions.

1.3.2.4 The interpretation of roots

In all of this, however, I distinguish the interpretation of roots from the interpretation of functional material. Despite the flexibility introduced by allosemy, typeshifting, coercion, etc., functional material is overall quite rigid and constrained. A functional head may be associated with several possible interpretations, but it will be a finite and discrete list. Roots are in general much more malleable, able to bend to the ‘structural semantics’ of functional elements. I assume that they have a distinct status in the syntax and semantics, in the following specific way.

It is common in DM to assume that roots need to be categorized syntactically to be licensed, and this generally means that they have to occur in the context of a category-determining head. Beyond this, it is often argued that roots do not introduce arguments or variables on their own. For example, it is thought that little v introduces the event variable, and that roots act as modifiers of the event. Other roots may modify states or entities.

However, in practice it is common to assume that roots are in fact predicates of different variables. An eventive root, for example, will be a predicate of a lambda-bound event variable, e.g. $\lambda e. \sqrt{\text{ROOT}}(e)$. This in fact is what allows it to modify the event variable ‘‘introduced’’ by v . But if that is so, then roots really are introducing event variables too, and heads like v are really introducing some extra semantics on top of that. In a model-theoretic system, it seems inevitable that if roots modify events, they must themselves carry event variables.³⁰

In the spirit of the idea that roots are flexible, and modify but do not really introduce different semantic types and the variables associated with them, I propose that a root is not abstracted over until it combines with something semantically. At the point of semantic composition, the root will become associated with a lambda operator and a variable, as in the following general rule.

$$(44) \quad \sqrt{\text{ROOT}} \rightarrow \lambda f_f. \text{root}(f)$$

This rule is triggered whenever the root is semantically adjacent to a lambda formula. The type of the variable will depend on the semantics of the root (what it is inherently compatible with) and the triggering environment. For example, if the root is combining with an event-denoting v , and the root is compatible with an event variable, it may take an event variable. If the root is compatible only with some other kind of variable, it will take whatever variable it needs to, as long as the composition works out. If the root is not compatible with anything that works out semantically, the structure will not have an interpretation, and it will be judged ill-formed by speakers.

³⁰ Thanks to Anton Karl Ingason for many discussions of this point.

In principle, there are number of ways of formalizing this that would be sufficient for my purposes in this book, but I will briefly elaborate on one possibility, drawing inspiration from the system discussed in Pross (2019), building on Roßdeutscher & Kamp (2010), Asher (2011) and others.³¹ Pross (2019) proposes that type-theoretically, roots are their own type, distinct from states, events, objects, properties and discourse representation structures. Lambda formulas can then abstract over this type, to combine with roots and integrate them semantically into the representation. For example, consider the English word *paint*, which can form a verb as in *paint the wall* or a mass noun as in *buy more paint*. Suppose, for simplicity, that in one case, the root directly modifies an event variable, and in the other, it directly modifies an entity variable. This could be formulated as follows:

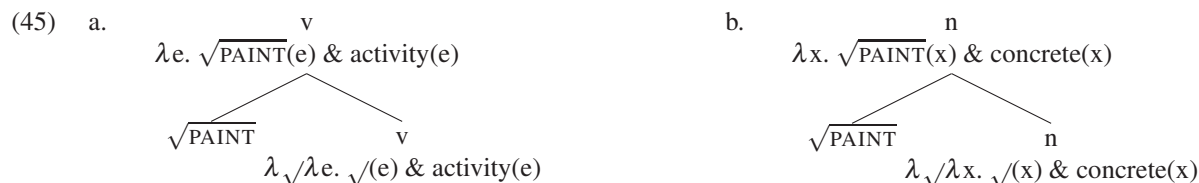

In (45a), *v* is looking for a root to serve as the predicate describing an activity event, and combines with the root adjoined to it for this purpose. In (45b), *n* is looking for a root to serve as the predicate describing a concrete entity, and combines with the root adjoined to it for this purpose.

We might then ask what is the “type” of roots that allows it to be a predicate of either events or entities (or other types). Pross (2019) proposes that roots form “dot types”, which is, in a sense, a set of types that they are compatible with. For example, we might assume that $\sqrt{\text{PAINT}}$ might be listed as $\langle \text{paint}, \text{OBJECT} \bullet \text{EVENT} \rangle$. Then, *v* has a constraint that whatever it combines with must be (or be able to be) an *EVENT*, and (at least this interpretation of) *n* has a constraint that whatever it combines with must be (or be able to be) an *OBJECT*. Since the root $\sqrt{\text{PAINT}}$ is listed *OBJECT*•*EVENT*, it can satisfy either constraint. Another root—say, $\sqrt{\text{CAT}}$ —might have a different dot type, perhaps only *OBJECT*, so it would not be able to combine semantically with the *v* head in (45a). This approach essentially hard-wires into the semantics of roots the kinds of things they can combine with, but crucially treats it as disjunctive, so that some roots will have a more flexible distribution than others.

Another possibility is that we do not formalize within the grammar any specific constraints on the types of variables that roots can serve as predicates of. Roots are their own type in the meta-language, with their own slots in semantic representations, and from a grammatical standpoint, any root can serve as the predicate to any variable, whether it is an entity, event, state, or anything else. Apparent restrictions on the distribution of roots can stem from their conceptual semantics (*speakers just cannot make sense of* $\sqrt{\text{CAT}}(e)$, for example) or from syntactic restrictions on their combinatorics ($\sqrt{\text{CAT}}$ cannot adjoin syntactically to *v* in the first place).

Any of these options would be compatible with the present system, and the reader is free to understand the rest of this book through the lens of whichever approach they feel has the most independent support. I will generally formalize my analysis along the lines of (44), but that is certainly not the only option, as I hope to have made clear here. What is crucial for this book is that roots must be underspecified in some way, so that their actual type is not fully fixed until they combine semantically with something. I believe that some version of this assumption is in practice at least tacitly adopted, or must be adopted, in most current work that takes the categorial distribution of roots seriously, but it is nevertheless not often mentioned explicitly. I do so here because it plays a crucial role in some of the analyses developed in later chapters, particularly in the analysis of various kinds of nominalizations that do not build on verbal meaning.

1.3.3 Compounding vs. Derivation

In the analysis pursued in this book, nominalizations have a structure that is in some ways similar to the analysis of at least some compounds pursued in various recent works, such as Harðarson (2016, 2017, 2018), Hu & Perry (2018),

³¹ What follows is an approximation of the spirit of Pross (2019), since his system has several aspects that may or may not be compatible with the overall approach in this book, but most importantly which are not required by the approach in this book, and so I hesitate to develop them in detail at this stage.

Ingason & E.F. Sigurðsson (2020), and Nóbrega & Panagiotidis (2020), where a categorized non-head is directly adjoined to the head.³²

(46) a. Nominalizing Structure

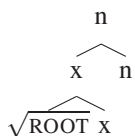

b. Nominal Compound Structure

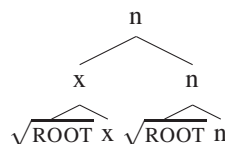

The difference is that in the present case, the “head” that is adjoined to does not have a separate, independent root adjoined to it. In fact, this difference is not innocent, and may not always be so obvious. As discussed by McGinnis & Wood (to appear), recent work within DM has proposed that what we call descriptively derivational suffixes are in fact category neutral roots (Lowenstamm, 2015; Creemers et al., 2018), either always or at least sometimes. This potentially blurs the lines between derivation and compounding, which McGinnis & Wood (to appear) argue is a good thing, because empirically, those lines are often blurred.³³

Nevertheless, there is one way in which I maintain a clear difference between structures like (46a) and (46b), drawing especially on Ingason & E.F. Sigurðsson (2020). In (46b), the righthand element, the head, cannot be semantically null.³⁴ Because of this, the compound as a whole will never have an interpretation identical to the interpretation of the lefthand constituent, and it will not inherit the meaning and argument structure of the lefthand constituent. In contrast, the structure in (46a) allows the possibility of a semantically null head, in which case the derived word will have the same meaning as the lefthand constituent, resulting in apparent argument structure inheritance. This is the analysis of the Complex Event Nominal reading, for example, but could in principle apply to any category.

This kind of difference can be illustrated with respect to the contrast between (47a) and (47b), taken from Di Scullio & Williams (1987, 33).

- (47) a. *a baker of bread*
 b. **a bakeman of bread*

(47a) involves an n head with no root adjoined, and so the theme argument of *bake* can be expressed by the complement of the derived noun. (47b) involves a compound—the n-head has a root $\sqrt{\text{MAN}}$ adjoined to it—so the theme argument of *bake* cannot be expressed by the complement of the noun. This difference follows from the way compounds are interpreted, where a relation would be computed between *bake* and *man*, with the resulting meaning in this case of a kind of man (or person), specified by *bake*. Thus, as Di Scullio & Williams (1987, 33) say, “an affixal head relates to its non-head differently than the head of a compound does.” According to the present account, (47a) involves an n-head with no root adjoined, so it does not get a special compound interpretation. In fact, I suggest in section 5.2.4 that in these cases, the n-head is semantically expletive, and that the agentive meaning comes from somewhere higher in the structure.³⁵

While Di Scullio & Williams’s contrast in (47) serves a useful illustrative function, I will admit that *bakeman* is not really an acceptable word in my judgment. But the discussion of (47) illustrates a more general claim. I can say *bakerman*, where the non-head *baker* is itself nominalized, and where, once again, the compounding structure prevents argument inheritance: **a bakerman of bread* is also unacceptable. This requires an explanation: if *baker* can inherit there argument structure of *bake*, and *bakerman* seems to mean the same thing as *baker*—which it does seem to—why can’t *bakerman* inherit the argument structure of *baker* (which in turn was inherited from *bake*)? The same argument could be made on the basis of words like *watchman*, which is an acceptable word, but unlike *watcher*, cannot inherit the internal argument from *watch*:

³² In various places in this work, I will adopt an analysis of compounds along these lines as well.

³³ For example, I will propose in this work, following Wood & Soares (2021), that the verbalizer *-væða* in Icelandic, which one might consider analyzing as the realization of a v head, is in fact a root adjoined to v rather than a realization of v itself.

³⁴ As discussed in section 6.5 below, this is because of how the compound structure is interpreted, where a relation is introduced semantically to mediate the interpretation of the head and the non-head, which in turn effectively entails that both must have a non-expletive interpretation, since there are arguably no linguistic relations that hold between some element X and nothing. (This would not really be a relation at all.)

³⁵ Drawing on the discussion in section 5.2.4, notice that if one were picking which potatoes to bake, one could point to one of them and say, “That one’s a baker for sure,” to mean that it should be baked; this shows that the n-head realized as *-er* is not necessarily interpreted as agentive.

- (48) a. γ a frequent watcher of the movies³⁶
 b. * a frequent watchman of the movies

To provide another example, consider the fact that nominalizations like *destruction*, etc., are often referred to as ‘event nominals’ or ‘action nominals’, or nominals that have an ‘event’ or ‘action’ reading (Comrie, 1976; Melloni, 2010; Iordăchioaia & Werner, 2019). This reading is sometimes encoded in the meaning of the nominalizer (Melloni, 2011). What noun has more of an “event” or “action” reading than the nouns *event* and *action* themselves? Indeed, these nouns do pass diagnostics for a Simple Event Nominal reading.

- (49) a. The event/action lasted two hours.
 b. The event/action went from one o’clock to three o’clock.
 c. The event/action took place at noon.

However, if the noun *event* or *action* heads a compound, then the resulting word cannot inherit the argument structure of the non-head.

- (50) a. the destruction of the city
 b. * the destroy event/action of the city
 c. the destruction event/action (*of the city) (took place at noon)

Unlike the case derived by affixation of an n-head in (50a), combining *destroy* with *event* by compounding (50b) does not lead to argument inheritance. In fact, *destroy event/action* is not well formed in the first place, but the example in (50c) makes the same point. It is well known that *destruction* can have the same meaning as *destroy* in cases like (50a), and this is often taken to be the ‘event’ reading. Since *destruction* can take a complement expressing the object of *destroy*, one might have imagined that *destruction event* or *destruction action* could as well; why would adding the word *event* or *action* to a word that already means ‘event/action of’ prevent this? But the fact is that argument inheritance is not possible in this case. According to the present account, this is because argument structure inheritance requires the nominalizer to be semantically expletive—it cannot actually mean “event/action of”—and the head of a compound, in this case the noun *event* or *action*, cannot be semantically expletive. This seems to be a fact, and following Ingason & E.F. Sigurðsson (2020), I assume it is because of the way that compounds are interpreted, as mentioned above and discussed further in section 6.5. What is important in the present case is that while the distinction between compounding and derivation is often blurred, and rightfully so, there is a sharp difference in the interpretation of these two kinds of structures that is relevant to the proposal pursued in this book.

1.4 Background on Icelandic DP structure

In this section, I provide a basic background on the Icelandic DP structure that will be assumed throughout this work, to help frame the facts discussed in the following chapters for readers who are not familiar with the details of the Icelandic DP. Many aspects of the Icelandic DP will not be directly relevant here, so I would refer the interested reader to H.Á. Sigurðsson (1993, 2006), Julien (2005), Pfaff (2015), Ingason (2016), and Harðarson (2017) for in-depth studies of the Icelandic DP.

1.4.1 Basic DP structure

With some exceptions, I generally adopt or assume the system of Harðarson (2017), in which the noun phrase in (51a) would have an underlying structure along the lines of (51b).

- (51) a. furðulegar kenningar Gísla um setningafræði
 bizarre theories Gísl GEN about syntax
 ‘Gísl’s bizarre theories about syntax’

³⁶ <https://www.buzzfeed.com/daily/dc-comics-superman-lgbtq-bisexual-jon-kent>, retrieved Oct. 14th, 2021.

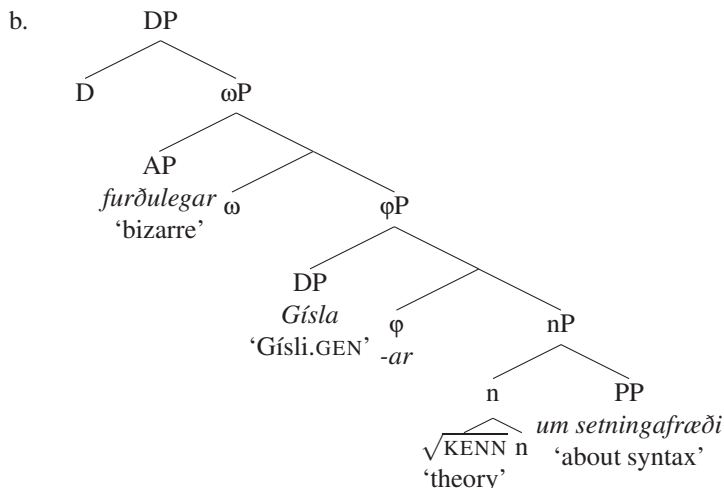

φ is the locus of inflection, such as gender and number, and corresponds to NumP in some other theories. ω encodes referentiality and licenses arguments—we will not be concerned with these properties here, but what is relevant is that it serves as the layer that allows adjectival modifiers.³⁷ In fact, this structure as presented is distinct from Harðarson's in two ways, both having to do with nP-internal structure. First, Harðarson (2017) assumes that the root projects a phrase, and the PP is the complement of the root, whereas I assume that the root is adjoined to n, and the PP complement is the complement of this n. Second, Harðarson (2017) proposes that the position of the possessor in SpecφP is a derived position, and that the possessor originates lower, in the specifier of the root. Below, I will also assume that SpecφP is a derived position for genitive DPs, but that they originate either in SpecPossP or as the complement to the n head.³⁸

First, however, it is worth highlighting how the surface word order is derived from this basic structure. First, the head noun moves by head movement to D, stopping at φ and ω along the way. Second, the adjective phrase moves to SpecDP. The derived structure is thus (52).

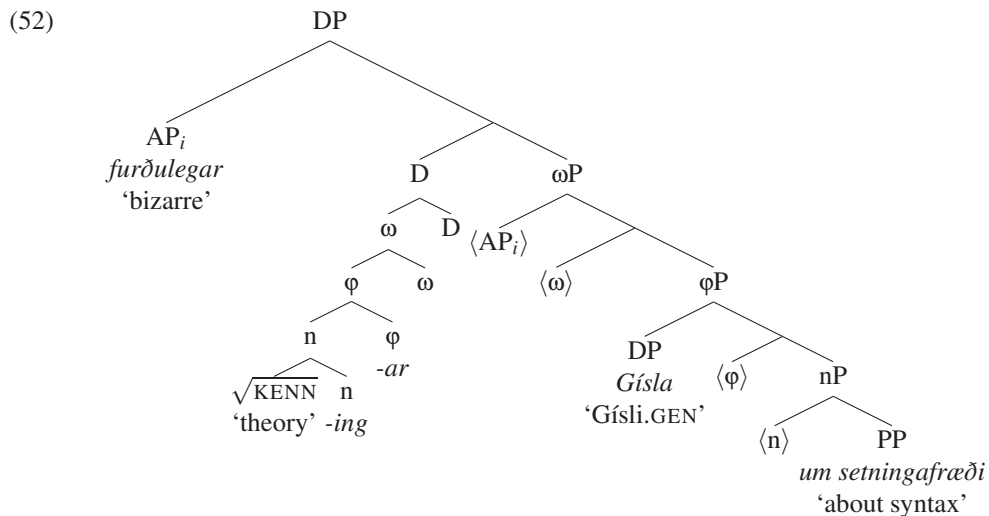

The key features to keep in mind here are as follows:

- Adjectives quite generally (though not always) move to SpecDP and thus precede the noun.
- Nouns precede possessors, but the relative order of possessors and complements remains unchanged.

³⁷ It also provides a position for the n head to move to when a demonstrative or other article occupies D, but the n head still precedes the possessor in SpecφP. Harðarson (2017) writes that it corresponds (in terms of position and function) to n and α in Julien (2005), Dx in Vangsnes (1999), and ix in Pfaff (2015).

³⁸ Delsing (1993, 1998) has a similar analysis, but refers to the derived position for genitive DPs as SpecPossP. His Poss head corresponds roughly to the φ-head here.

- When the possessor is a full genitive DP, D is generally null, but when the possessor is a possessive pronoun, D may be realized as a suffixed article.

Illustrating the last point, consider the noun phrase in (53a), which would have the derived structure shown in (53b).

- (53) a. *góðu myndir-nar mínar af Astrid*
 good pictures-the my of Astrid
 ‘my good pictures of Astrid’

(Adapted from Harðarson, 2017, 163)

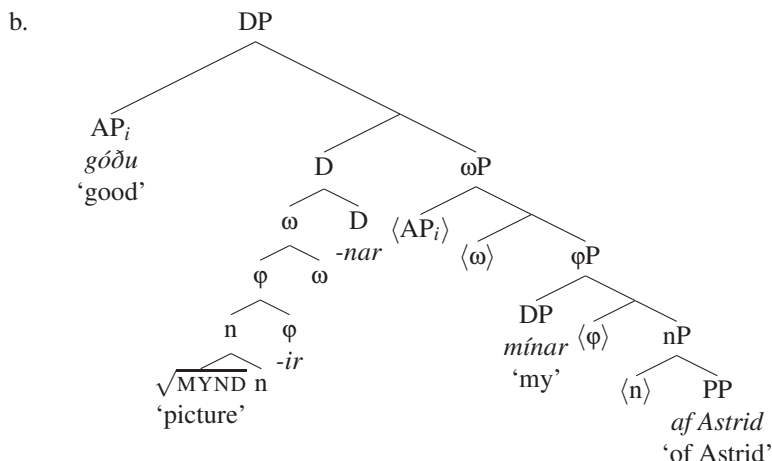

The overtness of the article shows that the noun has moved to D (though see Ingason 2016 for cases that he analyzes as involving lowering of D to the noun). While it is frequently argued that the adjective and the noun move together as a constituent to SpecDP (Julien, 2005; H.Á. Sigurðsson, 2006; Wood, 2009a; Pfaff, 2015), Harðarson (2017) argues that the noun and adjective come to precede the suffixed article by two separate movements, with the adjective undergoing phrasal movement to SpecDP and the noun head-moving to D (reviving to some extent the analysis H.Á. Sigurðsson 1993). Assuming head movement of the noun allows for a straightforward account of how complements are left in place at the right edge of the noun phrase, a fact that requires substantial stipulation in an account where the adjective and noun move together (Pfaff, 2015).

Returning to the question of the possessor, I assume the same basic relative position of the possessor to other DP-internal material as in Harðarson (2017). However, following Szabolcsi (1994), Barker (1995), Alexiadou (2003), Myler (2014, 2016), Baker & Gondo (2020), Tyler (2021) and others, I assume that the possessor is introduced by a dedicated functional head Poss (the way that agents are introduced by a dedicated functional head Voice).³⁹ I assume that this head is below φP, so that rather than (51b), the underlying structure of (51a) is (54).

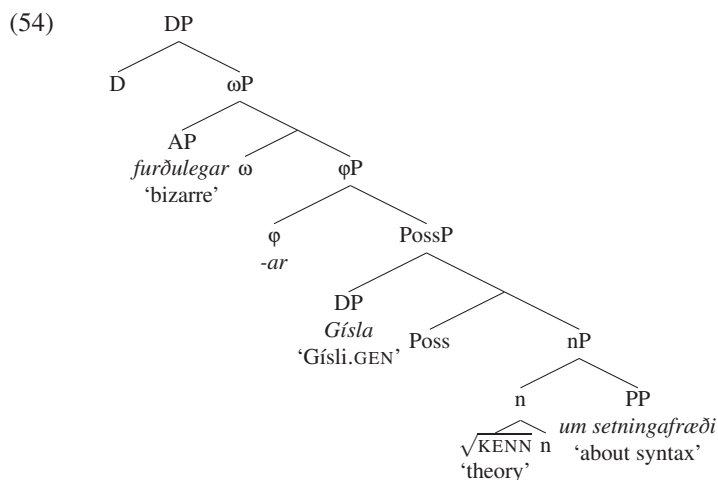

³⁹ See Pfaff (2015) for a different approach, inspired by Adger (2013), in which the head introducing the possessor takes the possessor as a complement and the nP as a specifier, but then projects the label of the specifier. If this is how noun phrases work in general, I believe it could be made compatible with the present approach; see Wood (2013) and Wood & Marantz (2017) for the general observation that for argument-introducing heads, specifiers and complements are in principle interchangeable.

With Harðarson (2017), we may assume that the genitive moves to Spec ϕ P, the noun head-moves to D, and the adjective moves to SpecDP.

1.4.2 Licensing genitives and genitive complements

There is one more, important consideration to mention, and that is the possibility that in addition to genitives originating in SpecPossP, nouns may in some cases take genitive complements. The examples in (55a) and (56a) are fairly clear instances of genitive complements.

- (55) a. minn hluti arfsins
my.POSS.NOM part.NOM inheritance.the.GEN
'my part of the inheritance'
- b. * Jóns hluti arfsins
Jón.GEN part.NOM inheritance.the.GEN
INTENDED: 'Jón's part of the inheritance' (Magnússon, 1984, 102)
- (56) a. minn helmingur garðsins
my.POSS.NOM half.NOM garden.the.GEN
'my half of the garden'
- b. * Jóns helmingur garðsins
Jón.GEN half.NOM garden.the.GEN
INTENDED: 'Jón's half of the garden' (Magnússon, 1984, 102)

However, only one genitive is allowed within a DP, as shown in (55b) and (56b). I assume that this is because DPs not licensed by a preposition must move to Spec ϕ P, and this requirement cannot be fulfilled by two DPs, as would be necessary if a single noun took a genitive complement and a genitive in SpecPossP at the same time. Thus, it is been observed that while possessive pronouns can co-occur with a genitive complement, genitive possessors cannot. Possessive pronouns distribute differently from genitives, and can be licensed in different positions.⁴⁰

Applying these assumptions to the analysis of deverbal nominalizations, we arrive at the basic underlying structures in (57).^{41,42}

- (57) a. eyðilegg-ing óvinarins á borginni
destroy-NMLZ enemy.the.GEN on city.the.DAT
'the enemy's destruction of the city'

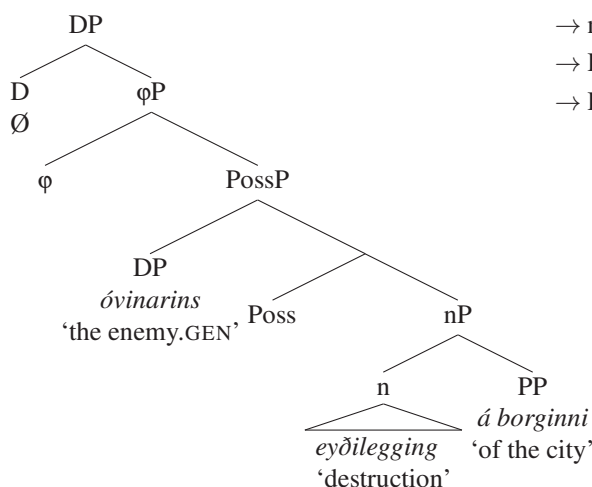

- n head-moves to D (through Poss and ϕ)
 → DP moves from SpecPossP to Spec ϕ P
 → D is null due to presence of genitive

⁴⁰ For example, when possessive pronouns follow the head noun, the head noun generally takes the definite suffix, as in *bók-in mín* 'book-the my' (= 'my book'). When they precede the head noun, which usually requires contrastive focus, the head noun may not take the definite suffix, as in *mín bók(*in)* 'my book(*-the)'. This pattern shows that possessive pronouns have a DP-internal distribution distinct from genitive DPs. See Delsing (1993, 1998) and Pfaff (2015) for detailed discussion.

⁴¹ For now, I remain agnostic about whether PossP is present in (57b,c), but later I will assume that it is the locus of agentive semantics, so it will be present whenever there is an implicit agent meaning in the nP.

⁴² Knittel (2010) proposes for French that the themes of nominalizations are introduced in the same position as possessors in non-event nouns. Although the details are somewhat different, the present proposal is similar in that themes of nominalizations are introduced in the same position that noun complements, including genitives, are introduced. In general, the syntax of complex event nominals and non-event nominals is the same, in the present proposal and in Knittel (2010).

- b. *eyðilegg-ing borgarinnar*
 destroy-NMLZ city.the.GEN
 ‘the destruction of the city’

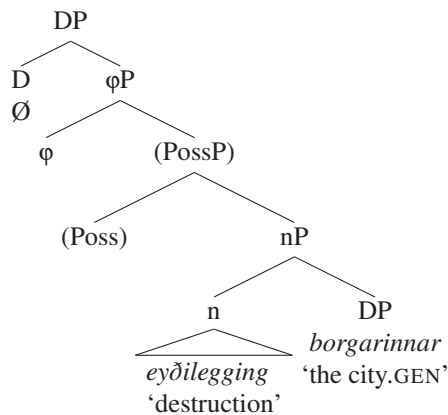

- n head-moves to D (through Poss and φ)
- DP moves from complement of n to SpecφP
- D is null due to presence of genitive

- c. *eyðilegg-ing-in á borginni*
 destroy-NMLZ-the on city.the.DAT
 ‘the destruction of the city’

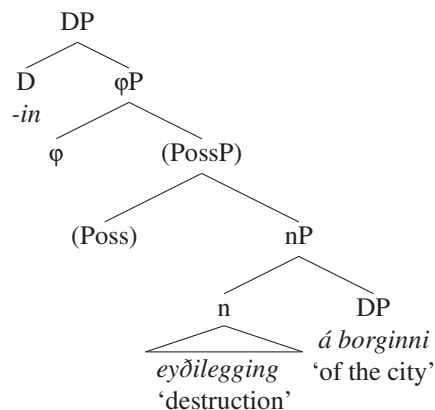

- n head-moves to D (through Poss and φ)
- DP moves from complement of n to SpecφP
- D is pronounced as the definite suffix due to absence of any genitive

I will say more about the difference between *á-PP* complements and genitive complements in what follows. For now, what is mostly important is that the reader is able to connect the surface word orders in the examples presented to the underlying structures that will be the primary topic of discussion. That is, I will mostly present the pre-movement structures, and I am mostly concerned with the structure up to PossP. So it is important to be able to parse why the genitive, adjectives, and complements appear where they do, since I will not generally show the full derivations from the underlying structures. It is also important for the reader to understand that the absence of a definite marker in the presence of the genitive is a general fact about Icelandic DPs (and in fact, there are dialects that do pronounce the article in such contexts (Jónsson 2008)), and not one that bears directly on the analysis of deverbal nominalizations per se.

1.4.3 Is there “quirky case” in Icelandic DPs?

Possibly one of the most well-known properties of Icelandic syntax, at least within generative grammar, is that DPs may have something known as “quirky case”. One might wonder whether there is quirky case internal to Icelandic DPs as well.

To answer this question, we must first clarify what is meant by “quirky case”. Essentially, what linguists describe as quirky case is a complete divorce of morphological case assignment from abstract “Case” licensing.⁴³ A DP can be assigned a case internal to the verb phrase, but still have to move to the subject position that would normally be associated with nominative Case (or to the object position that would normally be associated with accusative Case). This state of affairs is somewhat puzzling, since the notion of abstract Case in the first place was that the morphological case that we see in case-rich languages is a direct reflection of the licensing mechanism that governs the distribution of overt DPs (and explains the distribution of silent PRO in control constructions). The puzzle has led to various proposals in the literature, including the idea that DPs can get multiple cases, that DPs bear two kinds of case features, and that whatever is behind DP licensing is distinct from whatever is behind morphological case after all (H.Á. Sigurðsson, 1991, 2012b; Jónsson, 1996, 2009; Béjar & Massam, 1999; McFadden, 2004; Baker & Vinokurova, 2009; Pesetsky, 2013; Tyler, 2020). What is important in the present context, and is to some extent independent of all of these approaches, is that we understand where morphological case comes from in clauses, and what a parallel situation would look like within the DP.

Within clauses and verb phrases, examples of what is usually thought of as quirky case are usually analyzed as stemming from one of two sources. First, the verb or little *v* may assign dative or genitive to an underlying object DP (complement of *v*). That DP will show up with that case no matter what else happens, whether it moves to the subject position (as in passive or unaccusative constructions), object position (for example under Object Shift), or remains in situ. In the present system, I annotate the special *v* head that assigns dative or genitive to an object as v_{DAT} or v_{GEN} , respectively. Second, the verb phrase may contain an Appl(icative) head that assigns dative to the DP in its specifier, and that DP will remain dative, whether it moves to the subject position, object position, or remains in situ.⁴⁴

With this much in place, we can ask whether we see anything like this in the DP. Given the discussion of DP structure above, we saw that *n* can take genitive DP complements, so we might ask whether there are special subcategories of *n* that instead assign accusative or dative to their complements.⁴⁵ We might also ask whether there is an nP-internal Appl head (or something like it) that assigns some special case to a DP. Finally, we might then ask if any of these configurations, if they exist, lead to the DP in question being licensed in the same way that genitive DPs are licensed, by moving to Spec ϕ P in the present proposal.

As far as I know, there are no cases of accusative marked DPs that occur internally to a DP without having some other obvious licenser, such as an overt accusative-assigning preposition.⁴⁶ So there would seem to be no n_{ACC} that assigns accusative case to its complement. There is also no reason to assume a special n_{GEN} that assigns genitive to its complement in any special way. Genitive is the case assigned to DP complements and DP-internal DPs in general, and since we are considering a situation where the complement of *n* would move to Spec ϕ P regardless of case, we would not really be able to tell whether a special “quirky” genitive exists.⁴⁷

The only possible candidates that I know of for a DP-internal quirky case involve datives, and they are somewhat inconclusive. First, there are constructions where a DP seems to appear internal to a DP, and second, there are cases that might be analyzed as involving the raising of a dative DP out of the DP it is generated in. The latter could be, in principle, a situation where a DP is assigned dative internal to another DP, but instead of being licensed in Spec ϕ P, it moves into the clausal domain and is licensed there.

Turning to the first case, there is a construction with DP-internal possessor datives, mostly limited to body-part possession. Consider the examples in (58)–(60), from Thráinsson (2007, 95–96).

- | | | | | | |
|------|----|---|----|--|----------|
| (58) | a. | Háls hans var grannur. neck his.GEN was slim 'His nick was slim.' | b. | um háls hans around neck his.GEN 'around his neck' | (Formal) |
|------|----|---|----|--|----------|

⁴³ For the purposes of this section, I use a capital “C” when referring to abstract Case, as a notion distinct from morphological case.

⁴⁴ The present discussion is neutral on the question of whether objects ever truly stay in situ. It is uncontroversial that both direct and applied objects move at least sometimes under Object Shift.

⁴⁵ I assume with most of the literature here that genitive is the basic structural case internal to DPs, on par with nominative and accusative in the clause.

⁴⁶ Faroese, however, has a construction where a DP-internal possessor can appear in the accusative case (Petersen, 2016).

⁴⁷ This is in contrast to Lithuanian, where word order properties can distinguish between a structural genitive and an inherent genitive, as discussed in ?.

- (59) a. Hálsinn á honum var grannur.
neck.the on him.DAT was slim
'His nick was slim.'
- b. um hálsinn á honum
around neck.the on him.DAT
'around his neck' (Colloquial)
- (60) a. * Háls honum var grannur.
neck him.DAT was slim
'His nick was slim.'
- b. um háls honum
around neck him.DAT
'around his neck' (Poetic)

The 'poetic' possessor dative in (60) is only possible when it is contained in a DP that is contained in a PP, as in (60b). The kinds of possession that can be expressed in this way (most commonly body part possession) are usually expressed with a DP-internal PP, as in (59). One possible analysis is that body part possession involves a special n_{DAT} head that may assign dative to its complement, and that dative may move to Spec ϕ P. Alternatively, body part possessors are generated in SpecnP, SpecPossP, or even SpecAppIP, and with a special [DAT] feature on the relevant head (n, Poss, or Appl) to assign to its specifier. The DP in the specifier would then move to Spec ϕ P, just the same. Either of these alternatives, if correct, would be examples of DP-internal quirky case.

It is not clear that either alternative is correct, however. Both face the basic challenge that these constructions are limited to cases where the DP is contained within a larger PP, and there is no obvious explanation for this that I can think of under these accounts, and certainly nothing like that is seen in the clausal domain. Also different from the clausal domain, the purported DP-internal quirky constructions would alternate freely with the PP and genitive variants. There is some case variation in the clausal domain, and argument structure alternatives, but nothing, to my mind, quite so systematic as this. (But perhaps here one could successfully argue for a parallel.) An alternative that is mentioned briefly in footnote 21 in chapter 3 is that these constructions in fact involve a null P head that is licensed in the context of a higher P head; essentially (60b) is (59b) with the *á* deleted or silent. This would have to be fleshed out, of course, and I will not do that here, but it has the advantage that it directly derives the unusual distribution of DP-internal datives. Nevertheless, examples like (60b) are probably the best candidates that I know of for a structural analogue of DP-internal version of the kind of "quirky case" we see in the clausal domain.

The second case that is relevant here involves cases where a DP might be generated internal to another DP, assigned case there, and then move out of the containing DP into the clausal domain.⁴⁸ In Icelandic, there are numerous candidates for this, and they may involve dative or (rather less commonly) genitive DPs. Many examples involve a construction with body part possession and an idiomatic reading, and a dative external possessor (Jónsson, 2003, 152–153). Consider the examples in (61). (61a–b) show the colloquial/poetic alternation discussed immediately above. (61c) shows a construction where a dative is the subject and apparently related to the same head noun 'heart'.

- (61) a. í hjartanu í þér
in heart.the.DAT in you.DAT
'in your heart' (Colloquial)
- b. í hjarta þér
in heart.DAT you.DAT
'in your heart' (Poetic)
- c. Liggur þér eitthvað á hjarta?
lies you.DAT something on heart
'Do you have something on your mind?'

Wood & Livitz (2012) propose that in constructions like (61c), the dative originates within the DP, as in (61b), and raises into the clausal domain, where in this case, it becomes the subject. Indeed, they point out that inalienable PPs of the sort in (61a) can also raise into the clausal domain, for example when the possessor is reflexive.⁴⁹

- (62) a. ?Ég burstu tennurnar í mér.
I.NOM brush teeth.the.ACC in me.DAT
'I brush my teeth.'

⁴⁸ This was famously proposed by Szabolcsi (1983, 1994) for Hungarian, and has been a prominent analysis of possessor raising constructions ever since (see Tyler 2021 for thorough discussion and support for the existence of this kind of movement).

⁴⁹ Note that it is common to leave the PP out entirely in these contexts, but the point here is the possible orders when the PP is present.

- b. Ég bursta í mér tennurnar.
I.NOM brush in me.DAT teeth.the.ACC
'I brush my teeth.'

The PP-DP order in (62b) does not form a DP constituent. It cannot topicalize, for example.

- (63) a. * [_{CP} Í mér tennurnar [_{C'} bursta [_{TP} ég alltaf]]].
in me.DAT teeth.the.ACC brush I always
b. [_{CP} Tennurnar í mér [_{C'} bursta [_{TP} ég alltaf]]].
teeth.the.ACC in me.DAT brush I always

This suggests that the possessor PP in (62b) raises out of the DP into some low, vP-internal position. Constructions like (61) are extremely numerous in Icelandic, but they are also somewhat idiomatic. They occur with particular combinations of light verb (here *liggja* 'lie'), head noun (*hjarta* 'heart'), and sometimes prepositions or other material.⁵⁰ If Wood & Livitz's (2012) proposal is on the right track, then this kind of construction is "half" of a DP-internal quirky construction: it is like ordinary quirky subjects in that a DP's case is determined lower than its Case-licensed position, but in this case, the case marking is determined internal to a DP.

Another construction with this property, perhaps even more straightforwardly, is studied by Ingason (2016). Consider the data in (64). In (64a), the dative DP *stelpunum* 'the girls' is contained inside the DP (in the specifier of an nP-internal ApplP, according to Ingason's analysis). In (64b), the dative has moved to the edge of the PP.⁵¹ In (64c), the dative argument has raised into the clause, and in (64d), it has raised to the subject position (with the causing event being expressed in a kind of by-phrase).

- (64) a. Þeir dönsuðu [_{PP} til [_{DP} skemmtunar stelpunum]]
they danced for entertainment girls.the.DAT
'They danced for the girls' entertainment.' (Ingason, 2016, 86)
b. Þeir dönsuðu [_{PP} stelpunum_i til [_{DP} skemmtunar (öllum) t_i]]
they danced girls.the.DAT for entertainment (all.DAT)
'They danced for (all) the girls' entertainment.' (Ingason, 2016, 86)
c. Dansinn var stelpunum góð skemmtun.
dance.the.NOM was girls.the.DAT good entertainment.NOM
'The dancing entertained the girls well.' (Ingason, 2016, 58)
d. Stelpunum var góð skemmtun af dansinum.
girls.the.DAT was good entertainment.NOM by dance.the.DAT
'The girls were well entertained by the dancing.' (Ingason, 2016, 87)

If Ingason's (2016) analysis is on the right track, this, too, is an example where case-marking of a DP is determined internal to an nP, before the DP raises to the subject position in what would standardly be considered a "quirky subject" construction.

However, there does appear to be a major asymmetry between the clausal domain and the nP domain that has not, as far as I know, ever been given a real explanation. We do not seem to find particular lexical nouns that are listed to assign specific cases to DP complements that remain inside a DP. Even the cases discussed in this section are essentially productive, configurational constructions, with generalizations that apply to classes of head nouns, not specific lexical head nouns. To be more precise, in the verbal domain, we have pairs like *aka* and *keyra*, which both mean 'drive', but where *aka* takes a dative object and *keyra* takes an accusative object. In the current system this is analyzed as saying that the root $\sqrt{\text{AK}}$ occurs with v_{DAT} and $\sqrt{\text{KEYR}}$ occurs with ordinary *v*. We do not find analogous pairs where, say, the nominal *bill* 'car' take a genitive possessor but the nominal *jeppi* 'jeep' takes a dative possessor, or where *brún* 'edge' takes a genitive a complement but *yfirborð* 'surface' takes a dative complement.⁵² Why noun phrases and verb phrases differ in this way (or whether this difference is only apparent) must be left for future research.

⁵⁰ Very often, either the dative or the nominative can be subject, so one can find many examples in the list of complex predicates in Barðdal's (2001b, 54–55) study of predicates with this "alternating subject" property.

⁵¹ The movement is supported by the availability of a floating quantifier in the underlying position, and the fact that it remains within the PP, despite being left of the preposition, comes from the fact that the whole string *stelpunum til skemmtunar* 'the girls.DAT for entertainment' passes constituency tests and distributes like a PP. See Ingason (2016) for detailed study.

⁵² The closest we come is from that lexical items can vary as to whether they are treated as being alienable, inalienable, part-whole, etc. For example, *krakki* 'kid' is understood as denoting a life-stage rather than a relation, so its possessive structure is usually treated as alienable

1.4.4 Take-home points about DP structure

I would like to close this section by mentioning that some of the assumptions that I adopt here are for concreteness, and other possibilities are fully compatible with the claims I make here. For example, if one assumed that the adjective and noun moved as a constituent to SpecDP, that would be compatible with my proposal assuming that some general solution to the issue of where complements appear is proposed. And of course, this solution cannot be at odds with the parts of the analysis that are crucial. For this reason, I would like to be fully explicit about what aspects of the analysis of nP structure the proposal below does depend on:

- Categorized nouns, rather than roots, take complements.
- Possessors are introduced above nP in a separate projection (which I call PossP).
- Genitives may be introduced as complements to n or in SpecPossP (though only one genitive may be licensed within a DP).

It may be possible to modify these assumptions and retain the core intuitions of the proposal defended here, but these are the assumptions that my proposal as it is developed depends on.

1.5 About the data in this book

Much of the data in this book comes from attested examples and examples I elicited from (or discussed with) native speakers over the course of three trips to Iceland. Attested examples comes from web searches, in which case the URL is provided, or, more often, from the dictionaries at <http://snara.is>, the Icelandic Gigaword Corpus (Risamálheildin)⁵³ (Barkarson et al., 2022), which I note with the abbreviation RMH, or the Tagged Icelandic Corpus (Mörkuð íslensk málheild)⁵⁴ (Helgadóttir et al., 2012), which I note with the abbreviation MÍM. All of the examples that I present here have been discussed with at least four native speakers of Icelandic, and in many cases more than that. Please see the acknowledgments of this work for a list of speakers who were generous enough to work with me; I am deeply grateful to every one of them for every minute they were willing to spend with me. All examples taken from the linguistic literature are explicitly cited as such.

1.6 Outline of the remainder of the book

In the remainder of the book, I will argue in favor of the complex head analysis of nominalizations on the basis of a fairly detailed study of Icelandic.⁵⁵ I begin in chapter 2 by outlining the basic properties of Icelandic nominalizations. This chapter serves partly as an overview, but more crucially, I demonstrate that Icelandic nominalizations can exhibit all the criteria of the CEN readings, and also have the three-way ambiguity discussed above. This is important, because the arguments in what follows depend on the claim that Icelandic nominalizations cannot be cast aside as empirically distinct from or irrelevant to the theoretical framework developed for nominalizations in other languages. In chapter 3, I provide the central, Icelandic-specific arguments in favor of the complex head analysis as opposed to the Parallel Structures and, especially, the Phrasal Layering analyses. In chapter 4, I turn to the nominalization of verbs that select PP complements, and show how a complex set of patterns stem from locality conditions on root alloosemy, in a way that would be difficult, if not impossible to state in an independently motivated way in a Phrasal Layering analysis. In chapters 5 and 6, I show how the ambiguity of nominalizations and the inheritance of argument structure follow from a structure as long as we accept the existence of alloosemy in a way that parallels allomorphy. Chapter 5 focuses primarily on Complex Event Nominals, while chapter 6 focuses on Simple Event Nominals and Referring Nominals.

in expressions such as *krakkið mitt* ‘my kid’ (with the definite suffix), as opposed to *sonur* ‘son’ or *dóttir* ‘daughter’, which is understood as denoting a relation, so its possessive structure is usually treated as inalienable in expressions such as *dóttir mín* ‘my daughter’ (without the definite suffix).

⁵³ <http://malheildir.arnastofnun.is>

⁵⁴ <http://mim.hi.is/?mode=mim>

⁵⁵ In many ways, I feel that this study is only scratching the surface of this fascinating topic, but I also feel that there is enough in what follows to support the overarching argument.

Chapter 2

Icelandic nominalizations

This chapter presents a basic, general study of Icelandic nominalizations, which have received very little attention in theoretically-driven work. The goal is to characterize Icelandic nominalizations within the broad theoretical literature that has developed on the topic. I show how Icelandic nominalizations are quite similar to English derived nominals (and not, say, English gerunds), of the type marked by *-ation*, *-ment*, *-al*, *-ance*, and so on, though there are some important differences. I argue that Icelandic nominalizations contain *v*, but may not contain Voice. The overall conclusion will be that while the differences need an account, the similarities are strong enough that conclusions about Icelandic should bear on English, and vice-versa. This conclusion sets the stage for the Icelandic-specific issues raised in chapter 3.

2.1 Morphology and allomorphy

2.1.1 Realizations of *n* and *v*

Nominalizations in Icelandic are marked by a variety of morphological means. First, we find a variety of affixes that nominalize a verb. Some of the most frequently encountered include *-un*, *-ing*, *-sla*, and *-stur*, although other affixes can be found, such as *-n* in *misheyr-n* ‘mishearing’, *vör-n* ‘defense’, *-ð* as in *ger-ð* ‘doing’, *-aður* as in *aðskiln-aður* ‘separation’, *-ning* as in *skrá-ning* ‘registration’, *hvat-ning* ‘encouragement’, etc. Some examples of each of these affixes is shown below.

- (1) a. **-un**: *björg-un* ‘rescue’, *löng-un* ‘desire’, *opn-un* ‘opening’, *söfn-un* ‘collection’, *vönt-un* ‘need’, *ætl-un* ‘intention’, *frest-un* ‘postponement’, *lok-un* ‘closing’, *úthlut-un* ‘distribution’, *útskúf-un* ‘banishment’, *misnot-k-un* ‘abuse’, *tileink-un* ‘dedication’, *hót-un* ‘threat’, *kvört-un* ‘complaint’, *rit-un* ‘writing’, *sköp-un* ‘creation’, *ásök-un* ‘accusation’, *skip-un* ‘ordering’, *undr-un* ‘marvelment’, *ögrun* ‘discipline’, *áskor-un* ‘challenge’, *löng-un* ‘desire’, *fföl-g-un* ‘increasing’, *rækt-un* ‘growing’, *skoð-un* ‘observation’
- b. **-ing**: *eyðilegg-ing* ‘destruction’, *freist-ing* ‘temptation’, *lýs-ing* ‘description’, *spreng-ing* ‘explosion’, *breyt-ing* ‘change’, *eyð-ing* ‘deletion’, *útrým-ing* ‘extermination’, *pynt-ing* ‘torture’, *still-ing* ‘adjustment’, *veit-ing* ‘giving/awarding’, *afhend-ing* ‘delivery’, *ábend-ing* ‘indication’, *sending* ‘sending’, *freist-ing* ‘temptation’, *dreif-ing* ‘distribution’, *kynn-ing* ‘publicizing/getting to know’
- c. **-sla**: *brenn-sla* ‘burning’, *bræð-sla* ‘melting’, *eyð-sla* ‘consumption’, *fær-sla* ‘movement’, *greið-sla* ‘payment’, *hræð-sla* ‘fear’, *kenn-sla* ‘teaching’, *keyr-sla* ‘driving’, *útbreið-sla* ‘spreading’
- d. **-stur**: *ak-stur* ‘driving’, *bak-stur* ‘baking’, *blás-stur* ‘blowing’,¹ *lam-stur* ‘beating’, *les-stur* ‘reading’, *mak-stur* ‘smearing’, *mok-stur* ‘shoveling’, *rak-stur* ‘shaving’, *rek-stur* ‘conduct’
- e. **-a**: *kom-a* ‘arrival’, *kær-a* ‘accusation’, *kveðj-a* ‘say good-bye’, *sal-a* ‘sale’

¹ Note that when the stem ends in /s/, and the suffix *-stur* is added, the resulting word is spelled with only one /s/, as in *blástur* ‘blowing’ and *lestur* ‘reading’. I leave two instances of /s/ here in order to be morphologically transparent.

- f. **-n**: *misheyr-n* ‘mishearing’, *vör-n* ‘defense’, *skír-n* ‘christening’, *heimsók-n* ‘visit’, *laus-n* ‘release, solution’
- g. **-Ø**: *aðstoð* ‘assistance’, *dráp* ‘killing’, *hjálp* ‘help’, *morð* ‘murder’, *starf* ‘work’, *trú* ‘belief’, *gón* ‘starving’, *þökk* ‘thanks’
- h. **-ð**: *ger-ð* ‘doing’, *hneig-ð* ‘tendency’, *bygg-ð* ‘settlement’
- i. Others: *aðskiln-aður* ‘separation’, *skrá-ning* ‘registration’, *hvat-ning* ‘encouragement’, *stuð-ningur* ‘support’, *brun-i* ‘burning’, *gagnrýn-i* ‘criticism’,² *skort-ur* ‘lack’, *þvott-ur* ‘washing’

In general the choice of nominalizing affix is determined by the verb root whenever *v* is not overt, but by *v* whenever it is overt. Some examples of overt *v* are as follows:

- *-ka* tends to realize *v* when the root denotes a property (is typically adjectival)
- *-ga* tends to realize *v* when the root denotes an entity (is typically nominal)
- *-na* sometimes realizes *v* or Voice when the verb is unaccusative
- *-væða* often realizes *v* when a verb is derived from a categorized noun
- *-era* often realizes *v* when the root is a loanword

The following is a list of verbs that take overt verbalizing suffixes.³

- (2) a. *-ka* verbs: *blíðka* ‘make calm’, *dýpka* ‘deepen’, *grænka* ‘make green’, *kveinka* ‘wince’, *þrælka* ‘enslave’, *stækka* ‘enlarge’, *minnka* ‘diminish’, *hækka* ‘raise’, *seinka* ‘delay’, *fækka* ‘become fewer’
- b. *-ga* verbs: *auðga* ‘enrich’, *blóðga* ‘cut’, *blómga(st)* ‘blossom’, *fjölgga* ‘increase’, *lífga* ‘revive’, *móðga* ‘insult’, *nauðga* ‘rape’, *ráðga(st)* ‘consult’, *ryðga* ‘rust’, *saurga* ‘tarnish’, *syndga* ‘sin’, *tólga* ‘become covered in ice’, *höfga* ‘doze off’, *snúðga(st)* ‘get’
- c. *-na* verbs: *dökkna* ‘darken’, *fúlna* ‘stagnate’, *gildna* ‘get fatter’, *lífna* ‘come to life’, *sofna* ‘fall asleep’, *vakna* ‘wake up’, *bogna* ‘bend’, *rofna* ‘rip’, *þiðna* ‘thaw’, *roðna* ‘blush’, *blána* ‘turn blue’, *gulna* ‘turn yellow’, *sortna* ‘blacken’, *fölna* ‘wilt’, *kólna* ‘become colder’, *blotna* ‘get wet’, *rotna* ‘rot’, *bráðna* ‘melt’, *hitna* ‘heat’, *grána* ‘become gray’, *hlýna* ‘get warm’, *stirðna* ‘stiffen’, *þrútna* ‘swell’, *slakna* ‘become slack’, *hvítna* ‘become white’, *súrna* ‘become sour’, *gláðna* ‘become happy’, *svigna* ‘curve’, *þorna* ‘dry’, *hnigna* ‘decline’, *bólgna* ‘swell’, *harðna* ‘harden’, *skrælna* ‘dry out’, *storkna* ‘solidify’, *sölna* ‘wither’, *visna* ‘wither’
- d. *-era* verbs: *blammera* ‘insult’, *bróðera* ‘embroider’, *marinera* ‘marinate’, *sjarmera* ‘charm’, *stúðera* ‘study’, *traktera* ‘treat’, *organísera* ‘organize’, *próðúsera* ‘produce’, *skandalísera* ‘scandalize’, *rasjónalísera* ‘rationalize’, *sósíalísera* ‘socialize’, *stílisera* ‘stylize’, *fabúlera* ‘fabricate’, *spekúlera* ‘speculate’
- e. *-væða* verbs:⁴ *einkavæða* ‘privatize’, *hervæða* ‘militarize’, *iðnvæða* ‘industrialize’, *kjarnorkuvæða* ‘nuclearize’, *nútímavæða* ‘modernize’, *rafvæða* ‘electrify’, *ríkisvæða* ‘nationalize’, *siðnvæða* ‘moralize’, *sjálfvirknivæða* ‘automaticize’, *Spánarvæða* ‘Spain-ify’, *spænskuvæða* ‘Spanishize’, *stofnanavæða* ‘institutionalize’, *söluvæða* ‘commercialize’, *tæknivæða* ‘automate’, *tölvuvæða* ‘computerize’, *vélvæða* ‘mechanize’, *vígvæða* ‘militarize’
- f. Other verbs with overt verbalizers: *söng-la* ‘chant’, *flög-ra* ‘flutter’, *hug-sa* ‘think’, *hrein-sa* ‘clean’, *nei-ta* ‘deny’.

² Note that the *-i* on *gagnrýn-i* ‘criticism’ is distinct from the *-i* in *brun-i* ‘burning’, in that the former is invariant (and feminine) while the latter changes for case and number (and is masculine), and might not strictly speaking be a nominalizing morpheme at all. See discussion below.

³ In the compilation of these lists, I consulted a variety of works, including Bjarnadóttir (2005), Kristinsson (2004, 30), H.Á. Sigurðsson (1989), Kvaran (2005), Jónsson (2003, 2005). Some other possible realizations of *v* include *-ma*, as in *blá-ma* ‘color sth blue’, and *-va* as in *högg-va* ‘cut/hew’. See below for a discussion of the *-a* ending on nearly all Icelandic verbs (and verbalizers), which I believe is more like a theme vowel than a verbalizer.

⁴ Thanks to Anton Karl Ingason for bringing this class of verbs to my attention.

When verbs with *-ka*, *-ga*, *-na* or the verbalizers in (2f) are nominalized, the nominalizer *-un* is used.⁵

- (3) a. *seinn* ‘late’ (adjective)
 b. Flugfélagið sein-**ka**-ði vélinni.
 airline.the delayed-KA-PST plane.the.DAT
 ‘The airline delayed the plane.’
 c. sein-**k**-un vélarinnar
 delay-KA-NMLZ plane.the.GEN
 ‘the delay of the plane’ (Maling, 2001, 449)

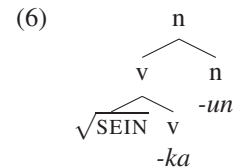
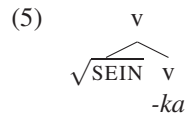
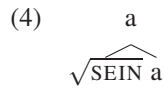

When v is realized as *-era* or *-væða*, the nominalizer is always *-ing*, as far as I know:

- (7) a. Guðrún analýs-era-ði vandamálið.
 Guðrún analyze-VBLZ-PST problem.the
 ‘Guðrún analyzed the problem.’
 b. analýs-er-ing Guðrúnar á vandamálinu
 analyze-VBLZ-NMLZ Guðrún.GEN on problem.the
 ‘Guðrún’s analysis of the problem’

We could thus model this as contextual allomorphy in the following way.

- (8) n ↔ *-stur* / { $\sqrt{\text{BAK}}$, $\sqrt{\text{MOK}}$, $\sqrt{\text{LES}}$, $\sqrt{\text{LAM}}$, ... } $\hat{\quad}$ ___
 ↔ *-sla* / { $\sqrt{\text{BREIÐ}}$, $\sqrt{\text{BRÆÐ}}$, $\sqrt{\text{KEYR}}$, $\sqrt{\text{KENN}}$, ... } $\hat{\quad}$ ___
 ↔ *-ing* / {*-era*, *-væða*, $\sqrt{\text{FREIST}}$, $\sqrt{\text{LÝS}}$, $\sqrt{\text{SPRENG}}$, ... } $\hat{\quad}$ ___
 ↔ *-un* / {*-ga*, *-ka*, *-na*, $\sqrt{\text{BJARG}}$, $\sqrt{\text{OPN}}$, $\sqrt{\text{FREST}}$, $\sqrt{\text{HÓT}}$, $\sqrt{\text{KVART}}$, ... } $\hat{\quad}$ ___

That is, the choice of n is generally sensitive to the roots, or to the affix like *-era*. I will assume that Icelandic in fact has no elsewhere form for n, and that this is why there are numerous verbs that simply cannot be nominalized in the language.⁶ For example, the most common verb for ‘eat’, *borða*, simply does not have a nominal form, even though there is nothing phonologically ill-formed about **borð-un*. To express this concept, speakers use the nominalized form of the less commonly used verb, *éta* ‘eat’, which is *át* (with no overt affix and a vowel change).⁷

As a side note, I should point out that the choice of nominalizer might not be as morphologically arbitrary as I have indicated above. Eiríkur Rögnvaldsson (p.c.) points out that there is a strong connection between the choice of nominalizer and the way past tense is expressed. Most (weak) verbs that take *-aði(r)* in the singular past tense take the nominalizer *-un*, and most (strong) verbs that take the past tense ending *-ti(r)/-di(r)/-ði(r)* in the singular past tense take the nominalizer *-ing*. Strong verbs that take neither of these past tense endings must find some alternative nominalizer. However, these generalizations are not absolute. For example, *moka* ‘shovel’ and *raka* ‘shave’ take *-aði(r)* in the singular past, but they are nominalized with *-stur*, not *-un*. Likewise, *keyra* ‘drive’ takes *-ði(r)* in the past tense but is nominalized with *-sla*, not *-ing*. There are various kinds of exceptions like this. Possibly they are systematic, but since nothing major hinges on it, I will continue to assume that there is a fairly arbitrary statement of which realizations of n occur in the presence of a given root.⁸

⁵ I assume that the preceding [a] is deleted phonologically, but it is also possible that it is a separate morpheme, a kind of ‘theme vowel’, given that the vast majority of Icelandic verbs end in [a].

⁶ In earlier versions of this work, I assumed that *-un* was the ‘elsewhere’ VI, and I still believe that if anything in the language is, it would be *-un*. The cost of the present assumption is that all instances of overt v must be listed in the VI rules in order for a nominalization to be possible. However, there are actually only a few exponents of v, so this doesn’t seem too onerous, and assuming that there is no elsewhere explains the fact that even *-un* cannot appear with some verbs where it might be expected, such as *borða* ‘eat’.

⁷ Actually, it’s worth noting that the vowel ‘change’ also occurs in other forms with the verb, such as the past tense (*át* is the simple past 1st/3rd singular form).

⁸ For example, one might encode some kind of ‘theme vowel’ insertion on v, and let that be predictive of both past tense form and the nominalizer. Exceptions could be dealt with by manipulating when the theme vowel is present, or by considering a phonological dimension

2.1.2 The Icelandic theme vowel *-a* is not a verbalizer

Absent from the list of overt verbalizers given above is the morpheme *-a*, which I believe to be more like a theme vowel familiar from Romance languages (among others) than a verbalizer. One reason for this is that the *-a* is actually a subpart of all of the verbalizers listed above: notice that *-ka*, *-ga*, *-na*, *-væða*, *-era*, etc., all end in *-a*. In fact, the overwhelming majority of Icelandic verbs end in *-a* in the infinitive. There are only a few exceptions, including some verbs that end in *-á* (IPA = [au])⁹, including *sjá* ‘see’, *þrá* ‘desire’, *dá* ‘admire’, *fá* ‘get’, *ná* ‘reach’, *gá* ‘look’, *slá* ‘strike’, *tjá* ‘inform’, *spá* ‘predict’, *sá* ‘sow’, *lá* ‘blame’, *skrá* ‘register’, *hrjá* ‘torment’, *þjá* ‘plague/bother’, *gljá* ‘glisten’, *flá* ‘flay’, etc., and the sole case of a verb ending in *-o*, namely *þvo* ‘wash’ (along with compound verbs headed by *þvo*). For all verbs except one, the third person plural indicative form is identical to the infinitive form.¹⁰

Moving past the infinitive, however, we can quickly see that there is not just one kind of *-a*. For one class of verbs, the *-a* remains in all singular indicative forms, past subjunctive, perfect participle, and the singular imperative.¹¹ This is the most productive class, and it is the one that newly coined or borrowed verbs in Icelandic almost always fall into. Of the overt verbalizers mentioned earlier, all of them are in this class except for *-væða*. Verbs of this class have a completely predictable paradigm of conjugations. Higher inflectional heads, include Tense, Mood, Aspect and Voice, do not trigger unpredictable ablaut or stem adjustments of any kind.¹²

For another class of verbs, the *-a* disappears in almost all forms other than the infinitive, including all past/perfect participles, all imperatives, and all finite forms other than 3rd person plural (which, as mentioned above, is the same form as the infinitive).

The distribution of *-a* is thus quite different from what we would normally expect of a derivational morpheme deriving verbs, and as mentioned above, the fact that it forms a subpart of the clear overt verbalizers suggests that it is something else. Rather than mark the category of verb overtly, its distribution seems to have more to do with inflection class and (non-)finiteness. In this sense, it is more like a theme vowel than a verbalizer. I believe that an adequate, let alone satisfying account of the distribution of *-a* is actually a more challenging task than one might expect. I will offer only a sketch of such an account here.

My tentative proposal is that *-a* is a realization of a dissociated node, which I will label as TH, that is inserted at PF adjacent to the right of little *v*. This rule, an instance of what Choi & Harley (2019) refer to as ‘Node Sprouting’, takes place prior to Vocabulary Insertion. At Vocabulary Insertion, there is a general rule that spells out TH as *-a*.

(9) Dissociated Node Insertion:

$$\begin{array}{ccc} & v & \rightarrow \\ \sqrt{\text{ROOT } v} & & \begin{array}{cc} v & \\ v & \text{TH} \end{array} \\ & & \sqrt{\text{ROOT } v} \end{array}$$

(10) Vocabulary Insertion: [TH] ↔ *-a*

This pair of rules inserts *-a* to the right of every verb. It will make it impossible for higher heads to trigger stem adjustments (such as ablaut), and it will make it impossible for the root to trigger special allomorphs of higher heads like Tense, Aspect, Mood, and Voice. As mentioned above, this is correct for the first class of verbs listed above. Formulating it in this general way means that we correctly predict that new verbs will be in this class.

to the choice of *n*. The point in this work is that we have one basic structure for word building, and different ways of realizing that structure. In considering the alternatives, it would be important to consider the complexity of the overall system along with what is gained; some generalizations might not be in the grammar, but might guide the acquisition of what the grammar treats as arbitrary, root-specific forms.

⁹ Note that in Icelandic, the acute accent marks do not mark stress, but mark segmentally distinct phonemes.

¹⁰ The sole exception is the verb *vera* ‘be’, where the third person plural is *eru*, not *vera*.

¹¹ It is replaced by *-i-* in most present subjunctive forms and *-u-* in most plural forms.

¹² Suffixes that begin with *-u-* can trigger the *-u-*umlaut rule, where an *-a-* in the stem becomes *-ö-*, but importantly, this is not a root-specific interaction, and is instead a morpheme-triggered phonological rule. See Valfells (1967), Anderson (1969a,b), Orešnik (1985), Rögnvaldsson (1981), Kiparsky (1985), Árnason (1992, 2005, 2011), Gibson & Ringen (2000), Markússon (2012), Þorgeirsson (2012) and Ingason (2013) for more on the *-u-*umlaut.

What remains is to specify the distribution of cases where *-a* does *not* appear. What I would like to suggest is that TH is deleted in the context of an Asp head and a listed set of roots.¹³ I take this to be an Obliteration rule in the sense of Calabrese (2011) and Arregi & Nevins (2012), where the entire node is deleted.¹⁴

$$(11) \quad [\text{TH}] \rightarrow \emptyset / \{ \sqrt{\text{ROOT}_1}, \sqrt{\text{ROOT}_2}, \text{etc.} \} \text{ ___ Asp}$$

The conditioning context of a list of roots accounts for the fact that *-a*-insertion is the general, elsewhere case in the language, and its absence is what must be learned on a case by case basis.¹⁵ The conditioning context of Asp accounts for the fact that the *-a* remains for almost all other verbs in the infinitive. The idea is that a certain amount of structure has to be projected in order to actually do the deletion for the roots that trigger it. Otherwise, the *-a* remains. All finite forms, the imperative and the perfect will project as high as Asp, so the deletion will apply. But it also allows us to manipulate the distribution of Asp to prevent the deletion from applying. For example, we can postulate a rule that deletes Asp in the context of 3rd person plural phi-features on present tense T. Since Asp is deleted, the rule in (12) will not apply, TH will remain and be realized as *-a*. We can also postulate that Asp is deleted in infinitive clauses, with the same results.¹⁶ Importantly, for contexts where Asp is not projected at all, such as “small structures”—vPs and VoicePs that serves as the complements of some other head, such as a causative head—the deletion rule will never apply.¹⁷

Finally, for the few cases of verbs that do not end in *-a* at all, a deletion rule very similar to (12) may be assumed, but without the “Asp” as a conditioning context.

$$(12) \quad [\text{TH}] \rightarrow \emptyset / \{ \sqrt{\text{PVO}}, \sqrt{\text{SJĀ}}, \text{etc.} \} \text{ ___}$$

There may be other contexts that trigger the deletion of TH, for example in the context of some roots and nominalizers (see discussion in footnote 8).

As I said, this is only a sketch of an account of the very interesting distribution of *-a*, and the details of such an account do not matter for most of what is at issue in this book. I will therefore end this subsection with a summary of what does matter. It is important that *-a* is something different from a verbalizer. While it does indicate the presence of a v, its distribution means that it cannot be easily used as a diagnostic for the presence or absence of v. The general intuition I have sketched is that the TH head that is realized as *-a* is inserted generally, but deleted in specific contexts. Its presence prevents allomorphy, and thus effectively creates one inflection class, and its absence allows allomorphy, and therefore allows the kind of interaction between a root and higher heads that creates distinct inflection classes. Finally, it is important to recognize that this *-a* is distinct from other *-a* morphemes, most importantly the nominalizer *-a*, the existence of which can create some potentially confusing “homophones”, such as the verb *kom-a* ‘come’, which is $\sqrt{\text{KOM}+\text{v}+\text{TH}}$ (when TH-deletion does not apply), and the noun *kom-a* ‘arrival/visit’, which is based on the same root $\sqrt{\text{KOM}}$, but where *-a* is a realization of n (or n_{infl} , as discussed in more detail in section 2.1.3).

2.1.3 The gender of derived nominals

The gender of the noun often appears to be determined by the nominalizer. For example, the *-stur* and *-ađur* affixes are masculine, the *-sla*, *-ing* and *-un* affixes are feminine. However, it is not clear whether this is really encoded as part

¹³ Anticipating the analysis of *-væða* verbs in section 6.5, *-væða* can simply be added to this list. However, it is also not necessary, because the environment conditioning such a rule can also be sensitive to particular Vocabulary Items, as well already know from the study of other languages, e.g. how English *-ity* realizes little n in the context of any little a that is realized by *-al*.

¹⁴ One might consider an alternative where a zero is inserted instead, for the same list of roots in the same contexts, and (10) is the elsewhere realization. For now, I stick with an account where a TH node is always sprouted, and then sometimes obliterated.

¹⁵ This leaves open the possibility that the acquisition of the deletion rule, that is, the absence of *-a*, may be aided by phonological or morphological sub-regularities, a possibility that does not directly bear on the present proposal. For example, it is possible that roots that already end in [a] do not get the theme vowel: it could be deleted phonologically in such cases, or it could be that such roots will generally end up on the list for deletion.

¹⁶ The syncretism between 3rd plural in the present tense and the infinitive form is then a consequence of Asp-deletion applying in both contexts.

¹⁷ That is, this is meant to capture the intuition that the *-a* appears as part of the citation form, even in the absence of more structure, and even if certain infinitives are analyzed as VoiceP or vP complements of a verb, where there is no reason to assume that there is, for example, a T head.

of the Vocabulary Item realizing *n*. Some of the affixes here are actually themselves morphologically complex. For example, the *-a* in *-sla* expresses gender, number and case, in this case feminine, singular nominative. It takes other suppletive forms for other number/case combinations. The *-ur* in *-aður* similarly expresses gender, number and case, in this case masculine, singular nominative, and there are other suppletive forms for other number/case combinations.

(13)

| | Singular Plural | |
|-----|-----------------|--------|
| Nom | -sl-a | -sl-ur |
| Acc | -sl-u | -sl-ur |
| Dat | -sl-u | -sl-um |
| Gen | -sl-u | -sl-na |

(14)

| | Singular Plural | |
|-----|-----------------|--------|
| Nom | -að-ur | -að-ir |
| Acc | -að-Ø | -að-i |
| Dat | -að-i | -uð-um |
| Gen | -að-ar | -að-a |

So for what I am calling *-sla* and *-aður*, it may be more accurate to consider the *-sl-* and *-að-* parts the overt nominalizers, and the remainder the fusional noun inflection material, which is sometimes expressed as a separate head (see e.g. Ingason & E.F. Sigurðsson 2015, who include a separate node for n_{Infl}).¹⁸ In fact, there is another nominalizer *-sli*, which might be composed of *-sl-* plus neuter *-i*.¹⁹

This point is relevant for the question of what counts as a zero-derived nominalization (an issue discussed further below), because some nominalizations are expressed solely with a nominal affix that fusionaly expresses number, case and gender. This is the case for *kom-a* ‘arrival’, which is built on the root $\sqrt{\text{KOM}}$ (from the verb *koma* ‘arrive’) and *brun-i* ‘burning’, which is clearly built on $\sqrt{\text{BRENN}}$ (from the verb *brenna* ‘burn’). The former is feminine and the latter is masculine.

(15)

| | Singular Plural | |
|-----|-----------------|----------|
| Nom | kom-a | kom-ur |
| Acc | kom-u | kom-ur |
| Dat | kom-u | kom-um |
| Gen | kom-u | kom-(n)a |

(16)

| | Singular Plural | |
|-----|-----------------|---------|
| Nom | brun-i | brun-ar |
| Acc | brun-a | brun-a |
| Dat | brun-a | brun-um |
| Gen | brun-a | brun-a |

This raises the possibility that in fact, the nominalizer itself is \emptyset in such cases, and the visible affix is solely the expression of the inflectional features. Assuming these are deverbal, this would look as follows, using the notation from Ingason & E.F. Sigurðsson (2015).

(17) a.

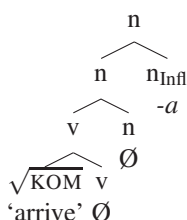

b.

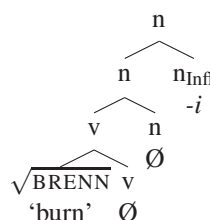

It is important to note that there is one other indication of nominalization in a case like *bruni* ‘burning’, however, and that is the fact that the vowel shifts from <e> (IPA = [ɛ]) in the verb *brenna* to <u> (IPA = [ʏ]) in the noun *bruni*. The importance of this point is the fact that some nominalizations have no overt affixes at all, but seem to mark the nominal solely with a vowel shift. This is the case for *dráp* ‘killing’, from the verb *drepa* ‘kill’ and *morð* ‘murder (n.)’ from the verb *myrða* ‘murder (v.)’. Such cases might be considered zero derived, with the nominalizer conditioning a readjustment rule on the root. Or, we might take such vowel shifts to ‘count’ as overt marking, for the purposes of any generalizations related to the presence/absence of an overt nominalizer. But this raises some concerns, because there are also some apparent cases of zero-derived nominals which have no overt affixes or vowel shifts, as in *gón* ‘staring’ from *góna* ‘stare’. It could easily be an accident that no vowel shift occurs (e.g. if the phonology of the root doesn’t meet the structural description of any readjustment rule), so there could then be zero-derived nominals that should ‘count’ as being overtly marked. Clearly, this could cloud any attempt to understand whether zero marking plays a role

¹⁸ In contrast, the *-un*, *-ing*, and *-stur* nominalizers keep their basic form throughout the paradigm, with some minor phonological adjustments.

¹⁹ This form is far less common for event nominals, however.

in any generalizations having to do with derived nominals. We will return to the issue of zero-derived nominals below, since this has been an important consideration in research on English nominalizations.²⁰

As for gender itself, Kramer (2015) argues that gender is encoded in the categorizing little *n* head (see also Kramer 2014, 2016; Kučerova 2018 and H.Á. Sigurðsson 2019). For Icelandic, then, there would be at least three *n* heads, one for each of masculine, feminine, and neuter (or whatever primitives those genders are made up of). Different roots would combine with distinct *n* heads.²¹ At Vocabulary Insertion, some VI rules would be sensitive to the gender features while others would not. In the cases of the ones that are not, one still might see the gender of *n* as it is reflected on the n_{Infl} head. Consider, for example, the contrast between *meiðsli* ‘injury’ (neuter) and *kennsla* ‘teaching’ (feminine).



Here we could assume that while some VIs always realize a particular gender—the suffix *-un* is always feminine, for example—others are underspecified.

$$(19) \quad \begin{array}{l} n_{\text{FEM}} \leftrightarrow -un / \{ \sqrt{\text{BJARG}}, \sqrt{\text{OPN}}, \dots \} \frown \text{---} \\ n \leftrightarrow -sl / \{ \sqrt{\text{MEID}}, \sqrt{\text{KENN}}, \dots \} \frown \text{---} \end{array}$$

That is, despite the fact that *meiðsli* ‘injury’ (neuter) and *kennsla* ‘teaching’ (feminine) seem to take different nominalizing suffixes with different genders, in fact they take the same realizations of little *n*. The difference isn’t in the spellout list—it is in the licensing of the roots in the context of n_{NEUT} vs. n_{FEM} . The n_{Infl} head expresses the featural gender difference that the VI rules are not sensitive to.²²

2.1.4 P-prefixing in derived nominals: A first look

Before moving on, there is one other aspect of the morphology of nominalizations that I would like to mention, which will be discussed more extensively in chapter 4, namely that prepositions and verbal particles selected by a verb frequently prefix to nominalizations derived from them. For example, *keyra* ‘drive’ forms *keyr-sla* ‘driving’. But when *keyra* is used with the preposition *á*, it means ‘get in an accident’. This meaning can be expressed in the nominalization by prefixing the preposition *á* to the nominalized form. In many cases, the preposition/particle may not prefix to a verb used as a verb, but only when it is deverbalized.²³

- (20) a. Guðrún **keyrði á** á Laugavegi.
 Guðrún.NOM drove on on Laugavegur
 ‘Guðrún got in an accident on Laugavegur.’

²⁰ In passing, it might be worth noting that *dráp* ‘killing’, *morð* ‘murder’ and *gón* ‘staring’ are all neuter, since we have not seen overt neuter nominalizing affixes yet, other than *-sli* (which, as mentioned, is not usually used on event nominalizations).

²¹ This is part of the general issue of root licensing in DM; just as some roots can combine with *v* and not *n* or *a*, some roots can combine with subcategories of *n*, *v*, *a*, etc.

²² This account raises the general question/issue of how big of a structure can be involved in the licensing of a root. This issue has not been addressed in sufficient detail, as far as I know. Most of the literature in the vP domain seems to agree that the root has to be able to ‘see’ at least as high as the Voice head, past little *v*, and it is possible that it can see as high as (at least some subcategories of) Asp above Voice. See ? and Wood (2016, 2017) for an account of licensing in terms of the semantic interface. In those accounts, root licensing is a subcase of root allomorphy, which would predict that a single root could appear with e.g. either *-sla* or *-sli* and get different meanings. An alternative would be to say that gender features are inserted post-syntactically, and then we would be concerned with the locality domain of such feature insertion. This alternative would predict that one root could not get differently gendered *n* heads with an effect on the root meaning.

²³ This phenomenon is common not only with nominalization, but also with adjectivization.

- b. **Á-keyr**-sla-n átti sér stað á Laugarvegi.
on-drive-NMLZ-the took REFL place on Laugavegur
'The accident took place on Laugavegur.'
- c. *Guðrún **á-keyrði** á Laugarvegi.
Guðrún.NOM on-drove on Laugavegur
INTENDED: 'Guðrún got in an accident on Laugavegur.'

Prepositional prefixing happens with all sorts of nominalizers, prepositions and verbs. It is a major form of word formation in Icelandic, ubiquitous in the language, and it seems to have systematic functions in deverbalization. I will return to this topic in detail, as it pertains to nominalizations, in chapter 4.

2.2 Complex event nominals

2.2.1 Basic CEN diagnostics

The goal of this section is to show that Icelandic nominalizations can be complex event nominals in the sense of Grimshaw (1990). Along the way, I will also show that they can be result/referring nominals or simple event nominals. The general argumentation here is that Icelandic is close enough to English that explanations for one should carry over to the other. This sets the stage for the argumentation in chapter 3. I also discuss the morphology of complex event nominals, and show that they are possible with a variety of suffixes, possibly including a -Ø suffix, as well as suffixes that fuse case, number and gender information.

Icelandic has the basic ambiguity between complex event (CEN), simple event (SEN), and referring noun (RN) readings, as shown in (21).²⁴

- (21) a. **CEN**
Eyðilegg-ing borgarinnar var hræðilegur atburður.
destruc-NMLZ.NOM city.the.GEN was horrible event
'The destruction of the city was a horrible event.'
- b. **SEN**
Eyðilegg-ing-in stóð yfir í marga daga.
destruc-NMLZ-the.NOM lasted over in many days
'The destruction lasted many days.'
- c. **RN**
Jón gekk sorgmæddur í gegnum eyðilegg-ing-una.
Jón walked aggrieved in through destruc-NMLZ-the.ACC
'Jón walked aggrieved through the destruction.'
- (Jóhannsdóttir, 1995, 63)

In this section, I will focus mostly on the CENs and their properties. Like English, internal arguments are generally obligatory with the complex event reading. So, for example, if a telic *á*-phrase is used (cf. Torfadóttir 2008), the internal argument must be expressed:

- (22) a. *Lýs-ing Jóns á einum klukkutíma
describe-NMLZ Jón.GEN in one hour
INTENDED: 'Jón's description (of something) in one hour'

²⁴ Jóhannsdóttir (1995, 63) marked (21b) ungrammatical, but it seems that she had the CEN reading in mind. Halldór Sigurðsson (p.c.) and Þórhallur Eypórssón (p.c.) point out that it is acceptable in the right context. Halldór Sigurðsson gives the context in (i):

(i) Óvinurinn réðst inn í borgina og eyðilagði allt sem fyrir varð.
'The enemy invaded the city and destroyed everything that they came across.'

- b. lýs-ing Jóns á landslaginu á einum klukku tíma
describe-NMLZ Jón.GEN on landscape.the in one hour
'Jón's description of the landscape in one hour'
- (23) a. * lýs-ing-in á einum klukku tíma
describe-NMLZ-the in one hour
INTENDED: 'the description (of something) in one hour'
- b. lýs-ing-in á landslaginu á einum klukku tíma
describe-NMLZ-the on landscape.the in one hour
'the description of the landscape in one hour'
... gekk í rauninni mjög vel.
... went in fact quite well
'... was in fact quite successful.'

Note that the internal argument requirement can be met by either the *á*-PP or by a genitive DP (though the latter is only possible when the external argument is not expressed as a genitive DP, as Icelandic noun phrases strictly allow only one genitive in a given noun phrase).

The use of such telicity phrases seems to be inherited from the verb. For example, *lesa* 'read' can be telic or atelic while *eyðileggja* 'destroy' is only naturally telic.

- (24) a. Anna las bókina { á einum klukku tíma / í einn klukku tíma }
Anna read.PST book.the.ACC { in one hour / for one hour }
'Anna read the book {in/for} one hour.'
- b. les-stur²⁵ bókarinnar á einum klukku tíma
read-NMLZ book.the.GEN in one hour
'the reading of the book in one hour'
- c. les-stur bókarinnar í einn klukku tíma
read-NMLZ book.the.GEN for one hour
'the reading of the book for one hour'
- (25) a. Þau eyðilögðu borgina { á einum degi / ?? í þrjú ár }
they destroyed city.the.ACC { in one day / ?? for three years }
'They destroyed the city {in one day/ ?? for three years}.'
- b. eyðilegg-ing borgarinnar á einum degi
destruc-NMLZ city.the.GEN in one day
'the destruction of the city in one day'
- c. ?? eyðilegging borgarinnar í þrjú ár
destruc-NMLZ city.the.GEN for three years
'the destruction of the city for three years'
- d. eyðilegg-ing-in á borginni á einum degi
destruc-NMLZ-the on city.the.DAT in one day
'the destruction of the city in one day'
- e. ?? eyðilegg-ing-in á borginni í þrjú ár
destruc-NMLZ-the on city.the.DAT for three years
'the destruction of the city for three years'

Like English, aspectual modifiers are possible, even when the noun is singular.

- (26) a. **margföld** eyðilegging óvinnarins á borginni
repeated destruction enemy.the.GEN on city.the.DAT
'the enemy's repeated destruction of the city'

²⁵ See footnote 1.

- b. **regluleg** eyðilegging óvinarins á borginni
 regular destruction enemy.the.GEN on city.the.DAT
 ‘the enemy’s regular destruction of the city’

In the relevant reading, plurals are ungrammatical, as are numerals:

- (27) a. ***Ein** eyðilegging á borginni (olli uppnámi).
 one destruction on city.the.DAT (caused confusion)
 b. ***Tvær** eyðileggingar á borginni (ollu uppnámi).
 two destructions on city.the.DAT (caused confusion)

Like English, implicit argument control is possible, both with purpose clauses (28a–b) and complement clauses (28c–d):

- (28) a. söfn-un sýna
 collect-NMLZ samples.GEN
 til að skrásetja hvarf sveppagróðurs
 for to document disappearance mushrooms.GEN
 ‘the collection of samples to document the disappearance of mushrooms’
 b. söfn-un stofnunarinnar á sýnum
 collect-NMLZ institute.the.GEN on samples.DAT
 til að skrásetja hvarf sveppagróðurs
 for to document disappearance mushrooms.GEN
 ‘the institute’s collection of samples to document the disappearance of mushrooms’
 c. löng-un Hlyns til að fara
 want-NMLZ Hlynur.GEN for to go
 ‘Hlynur’s desire to go.’
 d. sú ætl-un Hlyns að fara
 the intend-NMLZ Hlynur.GEN to go
 ‘Hlynur’s intention to go’

Whatever the explanation for these properties is in English, it should be possible to extend it to Icelandic, which is similar in the most important respects.

There is at least one sharp difference between Icelandic and English which should be mentioned. Unlike English, passive by-phrases cannot be used to express arguments:

- (29) a. eyðilegg-ing borgarinnar (*af óvininum)
 destr-NMLZ city.the.GEN (*by enemy.the.DAT)
 ‘the city’s destruction by the enemy’
 b. eyðilegg-ing-in á borginni (*af óvininum)
 destr-NMLZ-the on city.the.DAT (*by enemy.the.DAT)
 ‘the destruction of the city by the enemy’

The agent can, however, be introduced by a special kind of PP (with a somewhat formal flavor), *af hálfu* ‘by/from part’ + GENITIVE.

- (30) eyðilegg-ing borgarinnar af hálfu óvinarins
 destroy-NMLZ city.the.GEN by part enemy.GEN
 ‘the destruction of the city by the enemy’

The *af hálfu* phrases are in complementary distribution with agent genitives, suggesting that they really do target the same thematic role.

- (31) * *eyðilegg-ing* óvinarins á borginni af hálfu Jóns
 destroy-NMLZ enemy.the.GEN on city.the by part Jón.GEN
 INTENDED: ‘the enemy’s destruction of the city that Jón was responsible for’

Moreover, *af hálfu* phrases require a sentient agent, and they are not compatible with nominals that do not take agentive external arguments, such as *rotnun* ‘rotting’ (from the verb *rotna* ‘rot’).

- (32) a. * *rot-n-un* laufblaðanna af hálfu raka
 rot-NA-NMLZ leaves.the.GEN from part humidity.GEN
 b. * *rot-n-un* laufblaðanna af hálfu garðyrkjumannsins
 rot-NA-NMLZ leaves.the.GEN from part gardener.the.GEN

Natural causer PPs are possible in the form of *af völdum* ‘by/from cause’ phrases.²⁶

- (33) *rot-n-un* laufblaðanna af völdum raka
 rot-NA-NMLZ leaves.the.GEN from cause humidity.GEN
 ‘the rotting of the leaves from the humidity’

We will return later in the chapter to *af hálfu* phrases and the impossibility of ordinary by-phrases.

2.2.2 Allomorphs of *n* in CENs

We have seen (and will continue to see) plenty of examples of CENs with *-un* and *-ing*, which are the most common deverbal nominalization affixes, as far as I know. But I would like to briefly point out that complex event nominals can be formed by a number of the affixes seen above. For example, *aka* and *keyra* are different words for ‘drive’ and take different nominalizers (*-stur* and *-sla*, respectively), but both allow the CEN reading.

- (34) a. (*reglulegur / tíður*) *ak-stur* leigubílsins
 (regular / frequent) drive-NMLZ taxi.the.GEN
 ‘the (regular / frequent) driving of the taxi’
 b. (*reglulegur / tíður*) *ak-stur* Guðrúnar á leigubílnum
 (regular / frequent) drive-NMLZ Guðrún.GEN on taxi.the.DAT
 ‘Guðrún’s (regular/frequent) driving of the taxi’
- (35) a. (*regluleg / tíð*) *keyr-sla* leigubílsins
 (regular / frequent) drive-NMLZ taxi.the.GEN
 ‘the (regular / frequent) driving of the taxi’
 b. (*regluleg / tíð*) *keyr-sla* Guðrúnar á leigubílnum
 (regular / frequent) drive-NMLZ Guðrún.GEN on taxi.the.DAT
 ‘Guðrún’s (regular/frequent) driving of the taxi’

In fact, I have so far not been able to find many clear cases where the choice of nominal affix makes a strong difference. At the very least, a wide variety of nominalizers are available to form CENs, as well as the other readings we find in nominalizations. I will thus, in this book, consider any choice of *n* to be potentially relevant, and by and large not try to hinge any generalizations on the choice of a particular nominalizing affix.

2.2.3 A note on zero-derived nominals

I pointed out above that *morð* ‘murder’ looks like a zero-derived noun, except that vowel in the root is different in the verb *myrða* (IPA = [ɪ]) and the noun (IPA = [ɔ]). Such apparently zero-derived nouns also seem to allow the CEN reading, as suggested by the following attested examples:

²⁶ Note that the preposition *af* in Icelandic is ambiguous between ‘by’ and ‘from’, and in verb phrases introduces both passive agents and natural causers (cf. Kallulli 2007 on Albanian).

- (36) a. *morð yfirvalda á mótmælendum*
murder authorities.GEN on protesters
'authorities' murder of protesters'²⁷
- b. *morð Bandaríkjamanns á indverskum innflytjanda í Kansas*
murder American.GEN on Indian immigrant in Kansas
'an American's murder of an Indian immigrant in Kansas'²⁸

The nominal *morð* 'murder' passes other CEN diagnostics as well, including the licensing of telicity PPs.

- (37) a. *Morð Guðrúnar á tveimur einræðisherrum á þrem vikum vakti mikla athygli.*
murder Guðrún.GEN on two dictators in three weeks woke much attention
'Guðrún's murder of two dictators in three weeks drew a lot of attention.'
- b. *Morð tveggja einræðisherra á þrem vikum vakti mikla athygli.*
murder two dictators.GEN in three weeks woke much attention
'The murder of two dictators in three weeks drew a lot of attention.'

It has been suggested in the literature on English that true CENs always (or almost always) have an overt nominalizing affix (Grimshaw, 1990; Marantz, 1997; Borer, 2013). If this is true, then it is arguably something that should fall out of the system, and not be stipulated—something about the realization of *n* as zero being possible only when *n* attaches directly to the root, for example. Or, as Borer (2013) proposes (much like Marantz 1997), the absence of specific categorizing heads in the grammar altogether (see also Marantz 2022). However, even for English, there are a number of counterexamples. Harley (2009b) mentions *murder, capture, collapse, repair, defeat, censure, practice*, and others. Iordăchioaia (2019a,b, 2020a,b) argues extensively that zero-derived nouns in English may in principle pass all CEN diagnostics. She proposes that \emptyset is another (non-default/non-elsewhere) allomorph of *n*, alongside *-ation, -ance, -al*, etc. Lieber (2017) and Andreou & Lieber (2020) argue that zero-derived nouns (what they call 'conversion' nouns, following traditional terminology) have exactly the same range of readings as ATK-derived and *-ing*-derived nouns (see Fábregas 2014 for a similar claim for Spanish nominals).

For Icelandic, as mentioned above, it is not always clear how to decide whether a nominal counts as zero derived. Is it still zero derived if there is a vowel shift? What if it is marked by an affix that also—or even primarily—expresses case, number and gender? If we limit ourselves to cases where there really is none of these things, we may be overly limiting, and it is not clear why vowel-shift triggering zeros would not occur with roots that lack the appropriate vowel. Since we do not see any obvious correlation in Icelandic, the correlation in English has been shown to be problematic at best, and it is not even clear what counts as zero-derived in Icelandic, I will not actively pursue the question of whether zero-derived nominals are special in some way in Icelandic.

2.3 Further scrutiny of CEN diagnostics

Grimshaw's (1990) argument was that derived nominals are in principle ambiguous, not vague, and that various diagnostics disambiguate them—they force the CEN reading. Central to the claim, and to most discussions of this ambiguity, is the idea that arguments are obligatory in the CEN reading, in particular the internal argument. Therefore, applying any CEN diagnostic to a derived nominal should make the internal argument obligatory. There has been a fair amount of discussion in the literature of various exceptions to CEN diagnostics, and most if them have the property that the internal argument is not overtly expressed even though a CEN diagnostic is applied. This can lead to the conclusion that the distinction was not real to begin with—that there is no special "CEN" reading—or that the distinction is real but some or all of the diagnostics are fallible. It is the latter position that I take in this work. It is my view that the diagnostics are robust enough that they point to a real distinction in the grammar, but that there are various ways that each individual diagnostic can fail.²⁹

²⁷ https://skemman.is/bitstream/1946/13054/1/elinjorunn_maritgerd.PDF, Jan. 16, 2019.

²⁸ <http://eyjan.dv.is/eyjan/2017/03/01/bandarikjamenn-anaegdir-med-raedu-forsetans/>, Jan. 16, 2019.

²⁹ In fact, this may be true of most syntactic diagnostics, hence the repeated refrain in Sportiche et al.'s (2014) textbook that the failure of a particular test in itself is not informative.

2.3.1 Obligatoriness of internal arguments

One kind of apparent exception, for example, has to do with the fact that arguments are not always obligatorily overt, since they can be optional or implicit.³⁰ There are indefinite implicit arguments and definite implicit arguments; sometimes they seem to be represented by silent syntactic material, other times by the semantics of the verb.³¹ Consider the following examples from Port (2008):

- (38) a. Pete was walking around the mall. Tim followed.
 b. Pete was in a mall. *Tim followed.
- (39) a. Levenson cleaned the house today.
 b. Levenson cleaned today.
- (40) A: Why did you marry her?
 B: Because mother insisted/*required/*demanded.
- (41) a. Klein baked a cake.
 b. Klein baked a potato.
 c. Klein baked all day. (*Understood*: ✓cakes/*potatoes)

(38) shows that the definite implicit object of *follow* is sensitive to the event described in the previous sentence. (39) shows that *clean* licenses an indefinite implicit object; even if the house is salient in the discourse, the meaning of (39b) is that there was nonspecific cleaning of something. (Note that the verb *cleanse* does not license an implicit argument at all.) (40) shows that the clausal implicit argument introduced by A can be licensed by some verbs but not others. (41) shows that implicit arguments may be possible with only certain senses of a verb. The verb *bake* licenses an indefinite implicit argument when it is used as a creation verb (such as when baking creates a cake out of batter) but not as a change of state verb (such as when baking changes the state of an already existing potato).

The availability of optional objects and the licensing of implicit internal arguments is not fully understood, even within the verb phrase (which is much more thoroughly studied than the noun phrase). One might be troubled by cases where an argument seems to be obligatory with a verb but optionally implicit with a noun derived from that verb, and indeed cases like this call for an explanation. Reuland (2011) and Bruening (2018b) discuss examples of this, such as (42) below.

- (42) a. The city was in the way of a strong enemy army.
 *The enemy completely destroyed, which took them several days.
 b. The city was in the way of a strong enemy army.
 Yet, the complete destruction by the enemy took several days.

(Bruening, 2018b, 10)

The example in (42b) is supposed to be a CEN as diagnosed by the agentive by-phrase, and yet the internal argument is not overtly present, and the verb it is derived from does not allow the object to be left implicit, as shown by (42a). Although I am willing to grant the possibility of an implicit argument in (42b) or cases like it for the purposes of the present discussion, I would like to also mention that I do not think we should take this data at face value. First of all, I do not find this example perfect in the first place, and to the extent that it is acceptable, I suspect it is really an RN or SEN and that it is the by-phrase that is misleading. That is, the by-phrase is a kind of author/owner-type by-phrase, identifying the party responsible for the result or state of the noun *destruction*. Notice that the adjective *complete* points to the result of the change-of-state. When other CEN diagnostics are used, the internal argument seems to be just as obligatory as in the verb phrase.

- (43) The city was in the way of a strong enemy army. . .
 a. Yet, the enemy's complete destruction *(of it) took several days.

³⁰ See also Knittel (2010, 180) for discussion of implicit arguments in French event nominals.

³¹ Note that recent research into implicit arguments in general has shown that there are several ways of representing implicit arguments with silent syntactic structure (see Rizzi 1986; Bhatt & Pancheva 2006; Landau 2010; Legate 2014; E.F. Sigurðsson 2017; Wood 2017; Šereikaitė 2021; Sigurðsson & Wood 2021), and therefore the distinction between implicit arguments that are represented with silent syntactic material and those that are purely semantic or pragmatic is not necessarily a straightforward matter.

- b. Yet, the complete destruction *(of it) in less than a day still surprised us.
- c. Yet, the complete destruction *(of it) by the enemy in less than a day still surprised us.
- d. Yet, the enemy's intentional destruction *(of it) still surprised us.
- e. Yet, the intentional destruction *(of it) by the enemy still surprised us.

In (43a), the agent is a Saxon genitive, and the internal argument is obligatory. Why should this be the case, if the nominalization truly allows an implicit argument licensed by the context? (43b–c) include a telicity PP *in less than a day*, with (in 43c) and without (in 43b) the same by-phrase; the internal argument is obligatory. (43d–e) replace the adjective *complete* with the agentive adjective *intentional*, with the Saxon genitive agent (in 43d) and the same by-phrase (in 43e); the argument is obligatory. If the by-phrase in (42b) is unambiguously a product of a CEN reading, and (42b) is supposed to show us that the internal argument of a CEN can be licensed by this kind of context, then why do other CEN diagnostics not point in the same direction? These other facts still require an explanation. My strong suspicion is that the by-phrase in (42b) is not actually picking out a CEN reading in the first place.

Nevertheless, it is not my purpose here to argue that the situation (42) is supposed to be identifying never happens. That is, there may be cases where a CEN seems to license an implicit argument more easily than the verb it derives from does.³² What I would like to emphasize here is that even if such cases exist, we should not conclude that the distinction is wrong, because that presumes that we understand why the argument was obligatory with the verb in the first place—which we do not. Note that Bruening (2018b), who argues that CENs license implicit arguments even when the verb phrases do not, was not arguing against the existence of CENs. (Indeed, he was arguing very forcefully for a phrasal layering analysis.) His claim was that while verbs vary in terms of whether they allow implicit arguments, nominalizations systematically do:

Nominalizations as a class [...] have optional internal arguments that are interpreted as definites. They can therefore only be dropped when the context provides a unique, identifiable referent for the missing argument. [...] arguments of nominalizations are never obligatory in the syntax. Provided a suitable context, the arguments of nominalizations can always be dropped [...]

(Bruening, 2018b, 11)

Bruening (2018b) provides a sketch of a mechanical analysis for how to accomplish this. He proposes that the verb head-moves to the nominalizing N head (through Voice), and that in this derived local relationship, the selectional feature of the verb can be checked and identified. To the extent that this can be made to work, it hardly provides an understanding for why nominalizations should be able to do this. The same mechanism, for example, could be used to derive an implicit theme of a passive head, such that one passive head could simultaneously make both the external and internal argument implicit. As far as I know, no one has ever tried to claim that this happens. Moreover, there still seem to be a great many situations where the argument of a nominalization does seem to be obligatory, so Bruening's mechanism is too powerful. Still, at a certain level of abstraction, Bruening's point stands that some cases of apparent non-obligatoriness of arguments might be implicit arguments, and that even if implicit arguments are available in some nominalizations that are not available in the verbs they are derived from, this does not undermine the general existence of CENs as a distinct class.

So some apparent exceptions might have to do with the general issue of optional argumenthood and implicit arguments, with verb phrases and CENs, rather than the diagnostic failing to pick the CEN reading. Indeed, Grimm & McNally (2013) discuss various attested cases where CEN-diagnosing material seems to be present in the absence of an internal argument. (44a) has an agentive by-phrase with *destruction* and (44b) has the event modifier *frequent* with *interpretation*.

- (44) a. How does a country recover from 40 years of destruction by an unchallenged tyrant?
- b. This information was accepted with the frequent interpretation that those persons who did not show arm-levitation must be preventing it.

As discussed below, *frequent* may not be a particularly reliable diagnostic, but for present purposes, it is noteworthy that Grimm & McNally (2013) found that, "In general, when no *of*-phrase was present, the internal argument was nearly always recoverable" from the surrounding discourse. In the sentences in (44), the semantic internal argument is identified within that very sentence, namely *a country* and *this information*. Grimm & McNally (2013) conclude from this that there is no necessary distinction between CENs and SENs, claiming that "If [...] the lack of an *of*-phrase

³² Although I should admit that I would greet any such case with the same level of skepticism, and the cases I have seen in the literature are generally subject to very similar criticisms.

corresponds with internal arguments that are recoverable from the discourse context, that supports a view upon which nominalizations simply do not need to specify the internal argument if its referent is sufficiently salient.” I, however, would draw the opposite conclusion: the facts suggest that CENs are unlike SENs in that they need full argument structure; it’s just that some of that argument structure can be satisfied by implicit arguments (which may or may not be represented by syntactic structure). It has not, as far as I know, been shown that deverbal nominalizations are fundamentally different from verbs in their ability to license implicit arguments. Several of the examples mentioned by Lieber (2017, 40–41) also seem to involve identifiable implicit arguments.

- (45) a. The penalty was counseling for 16 weeks.
 b. I learned to knit not just from my mother’s intentional instruction. . .
 c. Lee had switched labels on two wines, and revealed that Parr had praised a 15 percent wine. See sfg.ly/hyac9X # **The intentional switch** stemmed, no doubt, from Parr’s vocal role in the. . .

(45) has an atelicity PP, and there is a clear implicit object referring to the person being punished (made salient even without more context by the word *penalty*). (45b–c) have the agentive modifier *intentional*, and a clear implicit object that is mentioned explicitly earlier in the sentence (for 45b) or a very recent earlier sentence (for 45c).³³

A simpler case along these lines involves nominalizations derived from verbs where the internal argument is clearly optional in the first place. The examples in (46) are given as examples which are missing an *of*-phrase. (46a) seems to have an external argument agent without an *of*-phrase, and (46b) seems to have an atelicity PP (*for three weeks*) without an *of*-phrase.

- (46) a. The shouting of the angry crowd drowned the rest of **Pia Ahn’s ranting**. (Lieber, 2017, 38)
 b. the cost of boarding for three weeks (Lieber, 2017, 40)

However, these examples are perfectly compatible with a CEN analysis that requires full argument structure, because the verbs they are based on—*rant* and *board*—do not require internal arguments in the first place, so there is no reason to expect that they would be required in a nominalization derived from them.

In addition, it is sometimes claimed that internal arguments are *only* possible with CENs, not with RNs or SENs, but it is not clear that this is true. Picallo (1991, 289), Alexiadou (2001, 13–14), Melloni (2010, 146), and Lieber (2017, 43) all provide examples of RNs with apparent internal arguments.

- (i) a. The discussion of the data (was published in a journal). (Picallo, 1991, 289)
 b. The translation of the essay (was on the table). (Melloni, 2010, 146)
 c. It was gigantic, nearly as big as my grandfather’s carving of Gog Magog, and a beautiful dark silver color. (Lieber, 2017, 43)
 d. That girl’s mix of Kool-Aid and Bacardi rum, along with Lisa’s concoction of Cherry 7-Up and grain alcohol, created quite a stir in the school cafeteria as students passed the drinks around. (Lieber, 2017, 43)

Importantly, arguments of this sort tend to be optional, and are not possible with all derived nouns. Note that Grimshaw (1990) argued that SENs and RNs can take complements, and that the interpretation of these complements is tied to the semantics of the head noun, but that they are not arguments in the same (technical) sense that the complements of verbs or CENs are arguments.

2.3.2 Pluralization of CENs

Another kind of exception has to do with how the CEN/SEN distinction tends—but only *tends*—to behave with respect to other aspects of grammar. One insight from the literature is that CENs tend to behave like mass nouns and SENs like count nouns, and that this underlies some of the diagnostics. However, the mass/count distinction, when applied to various roots, is notoriously flexible and hard to pin down. Therefore, a SEN might in some cases take on a mass noun

³³ It is possible that these examples involve a distinct use of *intentional*, discussed below, but I mention them here because the implicit object is clear and salient.

reading, and then it will seem to pass various CEN diagnostics, even though it does not have a verbal event variable or take an internal argument. Conversely, there are ways that CENs can become more like count nouns, in which case they will take on properties normally associated with SENs, despite having complex event structure and verbal arguments. For example, it has been argued that contrary to what was said above, CENs can pluralize in some cases (Mourelatos 1978; Borer 2005; Iordăchioaia & Soare 2008; Roodenburg 2010; Alexiadou et al. 2010a,b,c; Lieber 2017). Typically, this is true specifically of telic CENs.

- (47) a. There were three arrivals of a train.
 b. There was a capsizing of the boat by Mary.
 c. * There was a pushing of the cart by John.
 d. There was at least one pushing of the cart to New York by John.

(Examples from Alexiadou et al. 2010b, 10)

They point out that when a verb can occur with *-ing* or with an *-ATK* affix, *-ing* tends to be atelic, and therefore unacceptable with the plural. In other cases, *-ing* can pluralize:

- (48) a. the killing of the journalist / journalists
 b. the repeated killings of unarmed civilians

(Examples from Alexiadou et al. 2010c, 116)

Thus, we have a more nuanced situation than was understood from Grimshaw (1990) and presented in section 1.2.2: plurals should be possible with CENs, in principle, if the event is telic, and (for many cases) especially if the internal argument is plural. Pluralization is still a useful diagnostic for distinguishing between CENs and SENs/RNs, as long as this is kept in mind. The diagnostic may in some cases fail in another way, in cases where SENs are interpreted as mass nouns. Consider the following example from Grimm & McNally (2013), taken from COCA:

- (49) Rosenblatt and co-authors (1987) also reported that **at least 40 mg/L CIOsub2 gas treatment for one hour at 60 percent RH** effectively sterilized Whatman 3-mm filter paper strips. . . (COCA)

The atelicity phrase *for one hour* may suggest that this is a CEN, perhaps one with an implicit argument.³⁴ It is more likely, however, that *gas treatment* is interpreted as a mass noun. Notice that it is a compound with an instrument non-head, since *gas treated* is not acceptable as a verb. Possibly this nonhead (which is itself a mass noun) contributes to the mass noun interpretation of *treatment*, despite the latter being an SEN. It is well-known that count nouns can be coerced to mass noun interpretations in many contexts. So if atelicity phrases are really sensitive to the mass/count distinction, then they usually pick out CENs, which behave like mass nouns, but they can also apply to SENs, whenever they are interpreted as mass nouns.

Similar considerations hold for the following example, where the atelicity phrase *for four years* modifies *home*, which is obviously not a CEN.

- (50) After the Twin Towers crumbled, Union Square – my home for four years as a New York University student – became the makeshift memorial for 9/11. (Lieber, 2017, 42)

However, in this case it seems that two things are going on. First, *home* is being identified as a state, and it is that state which is modified by the atelicity phrase, which is expected to be possible since states are unbounded. Second, this is an appositive reduced relative clause, where *my home* is predicated of a relative operator identified by *Union Square*, and it is that predication that is modified by the atelicity phrase. Again, a predication of this sort is a state, so we expect atelicity phrases to be possible.

2.3.3 Adjectival modifiers

Yet another way that diagnostics can seem to fail is when they give a reading that overlaps with the intended reading, but is in fact distinct. That is, the diagnostic is, in a sense, not really being applied. This is often the case for adjectival

³⁴ Note the specialized style here, for example with *no of* between *40 mg/L* and *CIOsub2*, which may make an implicit object more likely. See the main text for another suggestion, however.

modifiers that are used to target the eventive reading. Such modifiers must be used with extreme care, because they can have several uses/readings and do not always target the eventive reading in the intended way. Consider the example in (51), discussed by Lieber (2017).

(51) Warren, too, is the frequent brunt of criticism. (Lieber, 2017, 42)

In this case, the adjective *frequent* seems to take a higher semantic scope than its syntactic position would suggest. It means that frequently, warren is the brunt of criticism. The adjective does not modifier *brunt* directly. The example in (52) is arguably similar: *frequent* does not apply to events of assuming, but to the entire predication: *frequently*, the assumption was that if a woman was sexually active, she would use the pill.

(52) The frequent assumption was that if a woman was sexually active, she would use the pill. (Lieber, 2017, 41)

This ability of some adjectives is entirely independent of the CEN/non-CEN distinction, and even of deverbal nominals and eventive meaning in the first place, as illustrated nicely by an example mentioned to me by Salvador Mascarenhas.

(53) I took a break and smoked a thoughtful cigarette.

Here, the meaning again involves a high semantic scope for the adjective, since the meaning is that I was thoughtful while I smoked a cigarette.

Another, related kind of issue can arise in the interpretation of adjectival modifiers. The adjective *intentional*, for example, can refer to the state of an object or its properties. Consider the example in (54).

(54) the intentional retroutopian town of Love Valley (Lieber, 2017, 42)

In this example, the meaning is that the town has retroutopian characteristics because someone intended for it to have retroutopian characteristics. It does not show that a noun like *town* shares semantic properties with agentive CENs; it shows that there are uses of the adjective *intentional* that are potentially misleading. It is something that has to be attended to carefully when using *intentional* as a diagnostic. Now consider the example in (55), in which *intentional* is used with the noun *insult*, which seems to be related to the verb *insult*, but does not have an overt nominalizing suffix or an internal argument.

(55) The main issue is the intentional insult, the intent to incite. . . (Lieber, 2017, 41)

However, this example arguably involves a use of *intentional* along the lines of (54). It is not identifying an implicit agent in the structure, but rather means something about the characteristics of the statement in question (or gesture, or whatever it was that was insulting) as something that has insulting characteristics because someone intended it to have insulting characteristics.

Despite all of this, we should not lose sight of the fact that there are some genuinely sharp contrasts involving modifiers like *frequent* and *intentional* that do seem to pick out the distinctions that we have in mind.

- (56) a. * Mary's {frequent/intentional} collection cost her the job.
b. Mary's {frequent/intentional} collection of illegal data cost her the job.

(56a) simply cannot have the meaning that (56b) has: the internal argument really is important for deriving a certain kind of eventive meaning, one that is forced by the adjectives *frequent* or *intentional* in this case. Lieber (2017) argues that constructed data such as these lead to faulty conclusions because we fail to construct the kind of discourse contexts that would make a sentence like (56a) acceptable. My view is that contrasts like (56) are real, and point to a real distinction in the grammar; examples like (56a) are ungrammatical because in constructing these examples, we constrain the discourse context to prevent the other options mentioned above from making themselves available. We do not provide a salient collection, abstract or concrete, whose characteristics can be said to be the result of someone's intending them to be so. We construct the sentence so that *frequent* cannot naturally take high scope over the sentence. Adjectival modifiers like *frequent* or *intentional* are still useful as diagnostics, as long as we are careful to attend to all of the ways that they can lead us astray.

2.3.4 Agentive by-phrases

Now, I should make it clear that I fully endorse the view expressed by Lieber (2017) that next to constructed examples and judgments, we need corpus studies to see how these constructions are used, and more or less for the same reasons, in that they can be used to help us identify counterexamples, or help us to better understand what factors underlie the contrasts we discover. I am arguing in this work that the CENs are distinct and special, and that it is the diagnostics that we use to identify CENs that might fail—it is not the case that the diagnostics succeed in telling us that CENs are not real. However, there are cases where it seems like a diagnostic is telling us one thing, but extra conditions on the functioning of that diagnostic, once understood, point in the opposite direction. Agentive by-phrases are one such case. Borer (2012), for example, claims that agentive by-phrases are not possible with synthetic compounds (see (57a)), while Alexiadou (2017b) claims that they are (see (57b)).

- (57) a. I watched the door breaking (*by Mary) Judgment from Borer (2012, 112)
 b. Taxi driving by John can be dangerous. Judgment from Alexiadou (2017b, 58)

In my judgment, the example in discussed by (Alexiadou, 2017b, 58) in (57b) is unacceptable; but her point is correct. Attested examples show that by-phrases are possible with synthetic compounds, but they are much better if they are generic or indefinite.

- (58) a. ... a device for preventing door breaking by burglars.³⁵
 b. ... to restrict taxi driving by unlicensed and dangerous drivers³⁶

This kind of restriction on by-phrases is found in other constructions as well, including adjectival passives, indirect causatives and *tough*-constructions (Alexiadou et al., 2014b; Sigurðsson & Wood, 2021). It is always possible that the unacceptability of definite DPs in by-phrases is what is important: that generic indefinite DPs do not “count” as passing the diagnostic.³⁷ But it is also possible that independent factors in particular constructions add constraints that make definite DPs in by-phrases unacceptable for independent reasons that are not relevant to the purpose of the diagnostic. The point here is that searching corpora for attested examples can sometimes raise these questions in a way that they might not otherwise be raised, and bring to light data of a sort that might not have been constructed otherwise. Nevertheless, I believe that in the area of CEN diagnostics, there is a genuine distinction, and the apparent counterexamples are failures of the diagnostic rather than the distinction. The best we can do is to apply as many diagnostics as we can and control for as many factors as we can to avoid faulty conclusions.³⁸

2.3.5 Nominalization of ECM structures

As mentioned in 1.2.2, Bruening (2018b) argues that contrary to what is generally assumed, English nominalizations in fact do allow raising and ECM, which he takes to support a phrasal layering analysis. He raises some facts that are challenging for any account of nominalization, including his own. Consider the following examples:

- (59) a. According to historians, that radical group was eager to start a civil war despite their acknowledgment of it to be folly. (Bruening, 2018b, 4) [Constructed]
 b. ... those acts that would be wrong must be wrong by virtue of some means other than God’s declaration of them to be wrong. (Bruening, 2018b, 4) [Attested]³⁹

The example in (59) seem to involve raising to object. The sentence in (59b) is attested, and the sentence in (59a) is constructed as an example of the text materials in a survey he conducted. The survey results showed that raising to

³⁵ <https://www.google.com.na/patents/US3910612>

³⁶ <http://medallionholders.com/docs/driving-poor.pdf>

³⁷ That is, their properties do not identify what we want them to identify, such as a Voice head.

³⁸ As far as I have seen, the most reliable positive diagnostic for CENs is telicity PPs such as ‘in X minutes’, in the sense that these always seem to require an overt internal argument when the latter is obligatory. Unfortunately, not all CENs are necessarily telic, so failing this diagnostic does not mean that something is not a CEN.

³⁹ <https://quizlet.com/94797180/attacking-faulty-reasoning-ch-256-quiz-flash-cards/> (Retrieved 8/2/2021)

object examples are degraded, but still much better than fully unacceptable control sentences. His interpretation of this result is that raising to object in nominalization is grammatical, but degraded by some external performance factors.

It appears that there are some (poorly understood) restrictions on what can appear with *of*, and this is what leads subjects to view raising to object with nominalizations as less than fully acceptable, since the raised object in a nominalization must appear with *of*. This is not about the grammaticality of combining raising to object and nominalization, however, it is something about the acceptability of different kinds of objects with *of* [...] One suggestion I will tentatively offer is that internal arguments marked with *of* in a nominalization are somewhat less acceptable if they are not canonical patients of the nominalized verb stem.

(Bruening, 2018b, 8)

However, his independent evidence for this seems to presuppose that we should expect all verbs/verb phrases to form nominals to begin with. For example, he supports it by showing that the first object of a double object construction cannot support *of* in a nominalization—something else his account would predict to be possible—and the fact that *-ing of* gerunds formed from various kinds of verbs are also not acceptable:

- (60) a. * this tent's sleeping of twenty people
 b. * his weighing of 200 pounds
 c. * his resembling of his wife
 d. * the trees' surrounding of the house
 e. * Martin's entering of the navy

However, one only expects these to be grammatical if one is deriving nominalizations from verb phrases to begin with.⁴⁰

Even if we take his suggestion to be correct, it is not clear that it is coherent within the grammar. Bruening argues that *of* is the realization of genitive Case assigned by the nominalizing N head. This means that when N merges with Voice, it must somehow prevent V/Voice from assigning accusative Case, so it can assign genitive Case past it. But then, *of* is only the *realization* of genitive Case: how can the PF realization of a syntactic Case feature depend on the LF interpretation of the object? If nominalization is truly syntactic and built on VPs, the grammar assigns Case and PF should realize it, full stop; prosody might effect PF realization, but thematic interpretation should not.

Moreover, Bruening (2018b) does not actually present evidence that there is actual raising into a verb phrase for ECM, for example from word order or adverbials. One alternative possibility compatible with a complex head analysis of the sort proposed in this book for Icelandic is that a preposition like *of* can take a TP complement, so that the structure would be (61), or that these are really control structures, so that the structure would be something like (62).

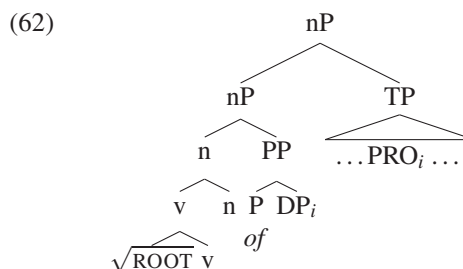
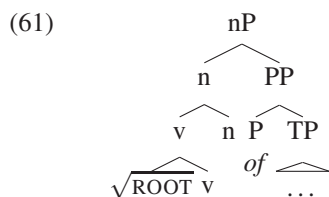

These may have a structure along the lines of *rely/depend/count on*, as in (63), which also form deverbal nominals, as in (64):

- (63) a. They relied on Mary to fix the car.
 b. They depended on Mary to fix the car.
 c. They counted on Mary to fix the car.
- (64) a. their reliance on Mary to fix the car
 b. their dependance on Mary to fix the car

⁴⁰ What the verbs in (60) seem to have in common is that they do not have external arguments, but instead have two internal arguments; see Bruening (2013) for discussion. In a Parallel Structures or Complex Heads analysis, this can thus be connected to the same constraint that rules out ditransitives with nominals.

- c. their counting on Mary to fix the car

As I alluded to in section 1.2.2, there are reasons to be skeptical of Bruening's (2018b) characterization of the empirical landscape of nominalizations. First, there is no real explanation for why so many examples are so clearly unacceptable, and without such an explanation, the analysis does not yet make the right cut in the data. Lieber (2017) also raises many counterexamples to various claims about nominalizations, but even she finds no examples of ECM, double object constructions, and particle shift. The absence or near absence of such cases is surprising on a Phrasal Layering account, and warrants an explanation. Lieber (2017) does present some examples of nominalizations of subject raising verbs.

- (65) a. His own father did nothing to hide his disappointment at his only child's failure to marry and provide him with grandchildren.
 b. Feelings of helplessness and defenselessness are contrary to the adolescent's tendency to feel invulnerable and virtually indestructible so this state presents them with a stressful situation.

Here again, I do not think we should necessarily rule out a control analysis of these cases. Note that expletives and idiom chunks do not seem to be possible; idiom chunks only have their literal interpretation.

- (66) a. * there's tendency to be too many people here
 b. # the cat's tendency to be let out of the bag
 c. # the shit's tendency to hit the fan
 (67) a. * there's failure to be enough people here
 b. # the cat's failure to be let out of the bag
 c. # the shit's failure to hit the fan

Nevertheless, the analysis in the present work does not depend on the outcome of the debate over the English examples of these kinds, for two reasons. First, the Icelandic case is, as far as I know, crystal clear, in that there are no examples of raising or ECM verbs that allow CEN nominalizations with arguments. Second, the Icelandic-specific evidence presented in chapters 3 and 4 is of quite a different nature, and raises additional challenges to a phrasal layering account and support for a complex head analysis. To preview what lies ahead, these problems include (a) the failure of case-inheritance, particularly (though not exclusively) with dative themes, (b) the difficulty of extending the account of English *of*-PPs to Icelandic *á*-PPs, (c) the nominalization of 'deponent' *-st* verbs, and (d) the range of patterns involving the interaction between P-prefixation, nominalization, and idiosyncratic meaning. This is enough, since the point of the present work is not to show that English nominalizations should be analyzed as complex heads, but that Icelandic should, which forms an existence proof that CENs can be formed without verb phrases. This is an important point whether English is an example of it or not.

2.3.6 The susceptibility of nominalizations to apparent counterexamples

Lieber (2017) argues that judgments, when applied to nominalizations, are particularly susceptible to leading us astray. I tend to agree with this assessment, and with her conclusion that in this area it is especially important to check our hypotheses and claims against corpus data. We might ask why, and here I can offer a few speculative suggestions. The main reason, I believe, stems from the fact that nominalizations, especially if the proposal in this book is on the right track, are very ambiguous. Even when they have single structure, the terminal nodes in that structure are subject to considerable allosemy. Eventive readings can come from *v* or *n*, can be contained in a concrete *n* or not, and roots can get idiosyncratic interpretations. Even beyond the semantic ambiguity due to allosemy, they are very often syntactically ambiguous. When *v* is not overtly expressed, a given string could involve a root attached directly to *n* or to the null *v* which is attached to *n*. This gives rise to more structures, and within each structure, semantic ambiguity. Moreover, there are mechanisms of semantic coercion that arguably have nothing to do with allosemy, such as the entity-to-event coercion seen in cases like *The shirt took 10 minutes* (when discussing ironing, for example). As if all of this was not enough, the diagnostics that we have available to pick out these distinctions are, as I have argued in this section, quite slippery. This is because above the level of the noun, DP-internal syntax is complex, and modifiers can

have different kinds of readings (see, for example, the study of adjectival modification in Cinque 2010, and much work on Icelandic DP structure, including Pfaff (2015), Ingason (2016) and Harðarson (2017)). These DP-internal processes interact with all of the ambiguity mentioned above.⁴¹

2.3.7 *Pluralia tantum and nominalizations*

However, there is another effect that I would like to discuss as part of the broad descriptive aspect of this work, although I will not be able to offer much insight into how it should be analyzed at this time. Essentially, some deverbal nominals seem to be *pluralia tantum*: they either only occur as plurals, or they only occur as plurals with the intended meaning. For example, cigarette packs in Iceland are often labeled with the warning:

- (68) Reyk-ing-ar drepa.
 smoke-NMLZ-PL kill.PL
 ‘Smoking kills.’

This is either derived from or at least shares a root with the verb *reykja* ‘smoke’; but the nominalization must be plural, although no particular plural meaning is intended (though see below for a qualification of this). Halldór Sigurðsson points out to me that this effect interacts with the meaning of the noun. For example, when the meaning is ‘smoking meat’ (i.e., cooking it with smoke), it is singular:

- (69) a. reyk-ing kjöts
 smoke-NMLZ.SG.NOM meat.GEN
 ‘the smoking of meat’
 b. ég setti laxinn í reyk-ingu
 I put salmon.the in smoke-NMLZ.SG.ACC
 ‘I set the salmon to smoke.’

Note, in contrast, the *drykkja* ‘drinking’, for consuming or drinking alcohol, is singular. Interestingly, this plural form can take arguments, but with some restrictions. (Note that even if this is a CEN, we do not expect the internal argument to be obligatory here, since it is not obligatory with the verb either.)

- (70) a. Reyk-ing-ar Guðrúnar ollu henni heilsutjóni.
 smoke-NMLZ-PL Guðrún.GEN caused her health.problems
 ‘Guðrún’s smoking caused her health problems.’
 b. (?) reyk-ing-ar Guðrúnar á vindlum
 smoke-NMLZ-PL Guðrún.GEN on cigars
 ‘Guðrún’s smoking of cigars’
 c. * reyk-ing-ar Guðrúnar á þessari sígarettu
 smoke-NMLZ-PL Guðrún.GEN on this cigarette
 ‘Guðrún’s smoking of this cigarette’

(70b) is, according to Halldór Sigurðsson, stilted but grammatical, while the (c) example is unacceptable. His intuition is that the plural indicates habituality or genericity, and is thus not compatible with a single event. This suggests that the plural is not semantically vacuous (even beyond interacting with the root meaning). However, since singular *reyking* ‘smoking’ cannot refer to the tobacco kind of smoking, this means that there is no way to form the equivalent of ‘Her smoking of that cigar yesterday got her fired’: *reykja* ‘smoke’ can be nominalized, but it must be generic/habitual.

⁴¹ Verb phrases also raise many issues, and can be ambiguous, and there are therefore a lot of discussions of the reliability and fallibility of diagnostics connected with verbal argument structure (Stroik 1992, 1999; Ackema & Schoorlemmer 1995, 2006; Lekakou 2005; Bhatt & Pancheva 2006; Folli & Harley 2006; Schäfer 2009; Biggs & Embick 2022). But even so, it is possible that verb phrases are somewhat less susceptible to these problems than noun phrases, because verb phrases ultimately must have an event variable of some kind that can be linked with a time interval variable; this limits the number of objects in the model that verb phrases can refer to. Noun phrases, on the other hand, do not need to be linked to time in the same way, and can point to almost any kind of entity in the model: concrete/abstract entities, states, events, propositions, etc.

If there is no *v* present, in this use of *reykingar* ‘smoking’ this is not a special problem for the present proposal, since of course the theory in general needs an account of *pluralia tantum*. However, if we take the presence of arguments in cases such as (70b) to indicate that *reykingar* ‘smoking’ can be a true CEN, and are thus derived (by assumption) from a verb and not directly from the root, this means that the plural feature must be able to interact in some way with the meaning of the root, raising the question of the locality of such interactions. Consider the possibilities in (71)–(73).

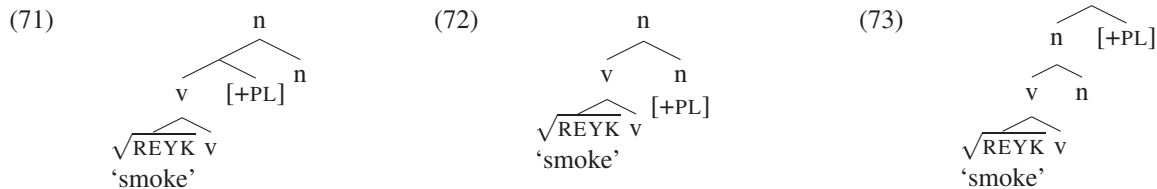

Recent work suggests that the plural feature of *pluralia tantum* nouns is located on the *n* head (rather than a Num head in the extended projection of the noun) (Acquaviva 2008; Alexiadou 2011; Alexiadou 2019), which would suggest the structure in (72), but (71) and (73) are logical possibilities that we should consider as well. If *pluralia tantum* plurals are derived with some node below *n*, even if it is outside of *v*, as shown in (71), then this is not a particular problem for most theories of locality per se. However, it is counter-intuitive to assume that plural marking is determined before categorization (since it would seem to require that the next thing merged be an *n* head), and something would have to be said about why the basic verb meaning is unavailable if *n* is merged without merging the plural feature first. Turning to the structure in (72), according to Embick’s (2010) theory of locality, the meaning of the root should not be able to depend on the features of *n* past a *v* head, assuming that both are phase heads. However, the general picture that emerges in this book is that roots can see up to two phase heads up the tree—but not beyond—so this analysis is compatible with that broad picture.⁴² The structure in (73) involves two phase heads between the root and the plural feature, which is of course the most liberal from a locality standpoint, and raises challenges to any constrained theory of the locality of allosemy.

However, even the analysis in (72) raises some technical issues. First of all, this analysis entails, assuming that *v* is semantically contentful in the CEN reading, that *n* and the root may interact allosemically even when they are not semantically adjacent, which is at odds with the general claim in this book. Second, the nature of the allosemic interaction is not clear. One would have to say that there is a reading of the root that is available in the presence of *v*, or *v*+*n*_{PLURAL}, but not elsewhere; it is unclear how to prevent the reading with *v* from appearing in the context of any other, non-plural *n*, without resorting to brute force. Third, we still must confront the apparent problem that the realization of arguments seems to be sensitive to aspect.⁴³

There are at least two reasonable responses to this problem. First, we should note that a very similar problem arises with gender. We have noted earlier that when *v* is morphologically \emptyset , the root appears to select the nominalizer by allomorphy—including its gender, as if gender were a feature of the Vocabulary Item rather than the syntactic head the Vocabulary Item realizes. This creates a potential feeding problem, since the gender feature so chosen must then be available for concord processes well above that particular head. One approach would be to assume that gender features are inserted at PF prior to Vocabulary Insertion, and that concord also takes place at PF in a way that is fed by this feature insertion. If so, the same mechanism could apply to number, where formal plural features are added at PF in the context of certain roots. Still, this approach faces the potentially fatal objection that such insertion is in fact sensitive to semantics, since the same root can get different interpretations depending on whether plural is inserted or not.

The second approach would be to argue that in fact, the problem is illusory: there is no *v* in such cases. They involve *n* attaching directly to the root. Either the CEN reading is in fact not available after all, or the presence of a CEN reading does not entail the presence of a *v* head. Recall, for example, that RNs can in some cases take arguments, contrary to the classic diagnostic. A crucial kind of example in this case would be one where we see the same effects—an obligatorily plural deverbal noun with a CEN reading—but the *v* head is morphologically overt, for example as *-ka*, *-ga*, *-na*, *-væða*, etc., so that we know that there is a verb there. At present, I do not know of any such cases.

⁴² Another approach would be to try to develop a dynamic theory of phases, as in Bobaljik (2012) and Bobaljik & Wurmbrand (2013) (see also Den Dikken 2007b; Gallego 2010; Bošković 2014; Wood & H.Á. Sigurðsson 2014; Moskal 2015), so that in these cases, *v* does not ‘count’ as a phase head.

⁴³ Yet another possibility is that the “plural feature” is actually on *v*, where it might be an aspectual or pluractional feature. The *n* head would then realize this feature as plural. This approach would solve many of the problems discussed in this subsection, but makes strong predictions that go far beyond the scope of the current work, so I do not discuss it further here.

Andreou & Lieber (2020) have recently discussed a similar set of cases with *-ing*-suffixed English nominals, including *fixings*, *winnings*, *drippings*, and others. Of these, *fixings* is the most idiosyncratic. It refers to ingredients used on some kind of food. For example, a cheeseburger “with all the fixings” would perhaps include lettuce, tomato, bacon, ketchup, mustard, etc. This meaning is entirely absent in the singular; one cannot order a cheeseburger with just one fixing, and fixing cannot refer to condiment or ingredient in general.⁴⁴ *Winnings* and *drippings* have a patient-noun-like reading, referring to the material that has been won or has dripped, and these readings are not possible in the singular. These examples are not eventive, however, and do not contain overt verbal morphology, so it is entirely possible that they are root-attached and not truly deverbal. Andreou & Lieber (2020) do not provide examples of eventive nominalizations that must be plural, or nominalizations with overt verbalizing morphology that must be plural.

Other examples of apparently deverbal nouns that are *pluralia tantum* in Icelandic include the following, kindly provided by Halldór Sigurðsson:

- (74) *skylm-ing-ar* ‘fencing’, *út-reið-ar* ‘horse riding trip(s)’, *kapp-reið-ar* ‘horse racing’, *burt-reið-ar* ‘jousting’, *sam-far-ir* ‘sexual intercourse’, *svefn-far-ir* ‘quality of sleep/dreams’, *tón-leik-ar* ‘concert’, *fim-leik-ar* ‘acrobatics’, *fá-leik-ar* ‘non-friendly relation’, *blíðu-hót-Ø* ‘affectionate treatment’, *vina-hót-Ø* ‘friendly treatment/attitude’, *fagnaðar-læt-i* ‘(loud) rejoice’, *skríls-læt-i* ‘hooliganism’, *fífla-læt-i* ‘buffoonery’, *ó-læt-i* ‘racket’

Not all of these are plausibly derived from verbs, and none of them show overt verbal morphology. Moreover, several seem to involve compounds which affect the overall meaning and it is not clear yet which, if any, can correspond to CENs. It is possible that this is entirely restricted to RN/SEN-kinds of meanings, not derived directly from the verb. For now, I must leave this interesting phenomenon for future research.

2.4 Presence/absence of v in nominalizations

This section discusses evidence for the idea that there is a v head embedded in Icelandic nominalizations. I first discuss the relationship between eventive meaning, obligatory argumenthood, and the independent existence of a verb. I then discuss the strongest evidence in favor of such a head, namely existence of nominalizations with overt v. Together, these considerations lead me to conclude that complex event nominals always contain a v head as well. Given the ubiquity of the ambiguity between referring, simple, and complex event readings, it is argued that the simple event readings and at least some (but perhaps not all) referring nominal readings contain v heads as well.

2.4.1 Eventive readings and Borer’s generalization

The correlation between eventive readings and argument structure has, for many, suggested that nominalizations are not simply built on top of a root, but contain a v head. Arguments are obligatory whenever modifiers target the event meaning, and we know that verbs are quite generally associated with eventive meaning in their most basic and common uses. Moreover, the same arguments are also obligatory in verb phrases headed by the relevant verbs. Alexiadou (2001), for example, proposed that event structure semantics corresponds to verbal structure. To inherit event structure, therefore, is to attach on top of verbal structure. Since arguments are obligatory in verb phrases, and nominalizations are built on verb phrases, argument structure is necessarily inherited in nominalizations that have event structure.

Moreover, Borer (2014) has emphasized the generalization that nominals with event structure and argument structure are always derived from an existing verb. Thus, the phrases in (75) are unacceptable because *vision* and *cognition* are not derived from verbs such as, say, **viz* or **cog*.

- (75) a. * the vision of the mountain by the instructors for three hours this morning
b. * the cognition about the problem for three hours by the philosophy student

A syntactic theory of morphology should be able to capture the connection between argument structure inheritance and verbal meaning.

⁴⁴ Interestingly, I find it possible to say “all but one of the fixings”, which suggests that it is not necessarily referentially plural.

I will argue in what follows that argument structure inheritance (at least for internal arguments) must be captured without building nouns on top of full verb phrases, as Alexiadou and Borer (and many others) propose. However, the generalization that complex event nominals entail the existence of the verb should follow from the system. I will therefore take the availability of the complex event reading to be diagnostic of the presence of little *v* in what follows. However, it should become clear that while this is a sufficient condition, it is not a necessary one: little *v* may sometimes be present in the absence of the complex event reading.

2.4.2 Overt *v* morphology

Perhaps the clearest argument in favor of a *v* head in nominalizations is cases where there is an overt exponent of *v*. As emphasized by Harley (2009b) and Alexiadou (2009), a syntactic theory of morphology like DM cannot ignore this kind of evidence. As discussed earlier, Icelandic has several overt exponents of *v*, the most frequent and clear cases being *-ka*, *-ga*, *-na*, *-era* and *-væða*. When verbs that are marked with these suffixes are nominalized, the verbal suffixes remain (although the *-a-* is deleted).⁴⁵ Some examples include *sein-k-un* ‘delay’, *ffjöl-g-un* ‘increase’, *hnig-n-un* ‘decline’, and *fa-kk-un* ‘decrease’.

(76) *sein-k-un* ‘delay’

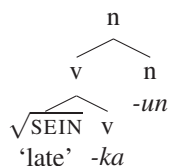

(78) *hnig-n-un* ‘decline’

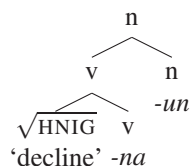

(77) *ffjöl-g-un* ‘increase’

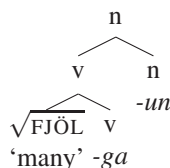

(79) *fa-kk-un* ‘decrease’

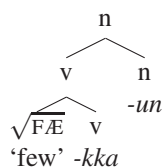

When verbs of this kind occur with a complex event meaning and argument structure, it only strengthens the case for including a little *v* head: both points reinforce each other. However, what is especially intriguing, as pointed out by Harley (2009b) and Alexiadou (2009), is the fact that these heads may show up with the meanings of simple event nominals (SENs) and referring/result nominals (RNs). This means that the SEN and RN readings cannot uniformly be derived by assuming that *n* is root attaching: they must be built, morphosyntactically, on verbs. Since we know that some SEN/RN readings can be built on top of verbs, and we take the availability of a CEN reading to entail (for that reading) the presence of *v* (whether it is overt or not), I will in general assume that when a nominal is ambiguous between a CEN reading and a SEN and/or RN reading, all three readings are built on the same structure.

However, I want to be clear that we should absolutely not just set aside the relevance of overt verbal morphology as settled; far from it. The above conclusion, I think, should be made for the most frequent and productive SEN/RN readings. But as Lieber (2017) has emphasized, apparently deverbal nominalizations can get many more readings than is often acknowledged. For example, Lieber (2017) takes *government* to have an ‘agent’ reading, since it refers to the body that governs, and *residence* or *reservation* has ‘location’ reading, referring to a location where one resides (or has been reserved). But these examples do not force us to say that deverbal nouns get agent or location readings. It is entirely possible that these nouns are built on roots.

⁴⁵ This deletion could be due to the phonology, since deletion of a vowel the context of a following vowel is independently attested in Icelandic phonology. However, it is also possible that the *-a* is something like a theme vowel, which is deleted or not inserted in nominal contexts. I set aside the choice between these two options here.

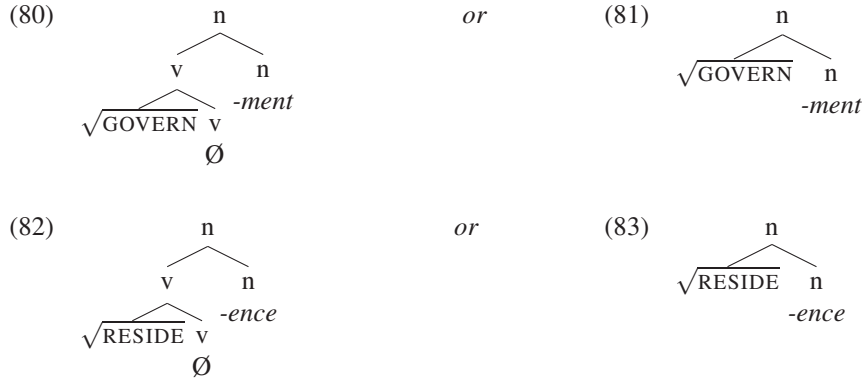

The question of whether ‘agent’ or ‘location’ readings are available in the genuinely deverbal structure cannot really be answered without looking to cases where *v* is overt, so that we can be sure that a *v* is present. So, for example, can *solid-ifi-cation* refer to an agent or group that solidifies things, or the location where solidification takes place? Can *terror-iz-ation* refer to the agent or group that terrorizes or the location where terrorizing takes place? My intuition is that they cannot, and this is in stark contrast to other readings that are easier to construct. For example, it is easy to imagine *solidification* referring to an entity that came about as a result of a solidifying event (as in “When you are finished solidifying the compound, take the solidification down to the supervising office for inspection”).

The point here is that the overtness of *v* can tell us something about the construction of different readings. An overt verbalizer in the CEN reading is unsurprising, given previous assumptions from almost all perspectives. But the fact that *v* can be overt in SEN and some RN readings means that such readings must be constructible on verbs. That does not mean that all RN readings must be; but the most productive ones found in the context of overt *v*, such as the result reading, must be. I will therefore assume that whenever there is a noun that is ambiguous between a CEN reading and either an SEN reading or one of the productive RN readings (like the result readings), there is a verbalizer present for all readings.

2.5 Presence/absence of Voice in nominalizations

There are a variety of facts pertaining to the question of whether Voice is available in Icelandic nominalizations. In this section, I discuss some of the relevant issues/questions, and including morphology, passive vs. unaccusative readings, the availability of the self-action reading, restrictions on the subject, and agentive modifiers. Ultimately, the conclusion is that there is no compelling reason to assume Voice inside nominalizations, and there are good reasons to assume it can be absent. I proceed with the conclusion that there is no Voice head inside nominalizations.

2.5.1 Overt Voice morphology

One indication of whether Voice is present in a nominalization is whether there is overt Voice morphology (Markova, 2010; Ntelitheos, 2012). For Icelandic, there are at least four morphological markings bearing on the presence or absence of Voice that we might consider. First, we might look for passive morphology, which in Icelandic is participial, much like English. Second, we might look for *-st* morphology, which marks certain anticausatives, and may signal the presence/absence of an external argument. Third, we may look for *-na* morphology, which marks certain anticausatives, and may signal the presence/absence of an external argument. Fourth, we may look for stem changes associated with the causative alternation, which may be taken to signal the presence/absence of an external argument.

In fact, we find nothing like passive participle morphology, much like in English. However, this might not be telling us much, since participial morphology arguably attaches outside of VoiceP, a view which has been defended from various perspectives (Embick, 2003, 2004; Bruening, 2013; Alexiadou et al., 2015). Nor do we find *-st* morphology. This is arguably because *-st* is a clitic licensed in the inflectional field, so it cannot appear in a nominalization; see section 3.2.3 for a discussion of issues raised by this fact, as well as the discussion of *opnun* ‘opening’ in section 2.5.2

below. The *-na* morpheme, however, can be found in certain cases that are arguably unaccusative CENs, such as *rotnun* ‘rotting’.

- (84) a. Veðurfar er svalt, vaxtartími plantna stuttur og
 weather.conditions is cold growth.time plants.GEN short and
rot-n-un lífrænna efna hæg
 rot-NA-NMLZ organic material.GEN slow
 ‘The weather is cold, the growing season for plants short,
 and the rotting of organic material slow.’ (MÍM)
- b. Myglusveppir [...] hafa það hlutverk að brjóta niður og flýta fyrir
 mold.mushrooms have that role to break down and speed up
rot-n-un á lífrænum leifum
 rot-NA-NMLZ on organic residue
 ‘Mold mushrooms ... have the function of breaking down
 and speeding up the rotting of organic residue.’ (MÍM)

Wood (2015) suggests that *-na* is an overt realization of an expletive, specifierless Voice head, marking morphologically the absence of a syntactic or semantic external argument. If so, then examples like those in (84) suggest that *n* can attach on top of Voice, as in (85) below. However, Wood (2015, 126) notes that it is also possible to analyze *-na* as a particular kind of *v*, that occurs, for certain roots, in the absence of a transitive Voice. This suggestion would be compatible with the structure in (86), with no Voice head.

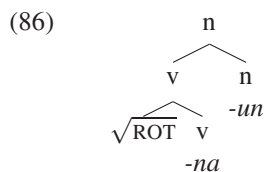
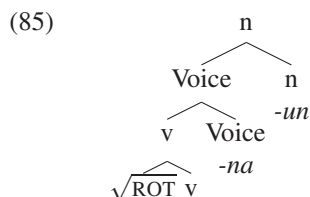

Therefore, the appearance of *-na* does not necessarily force us to conclude that Voice can appear inside nominalizations.⁴⁶

As for stem morphology, certain transitive/intransitive pairs are marked by different forms of the root. This is illustrated with the verb *brenna* ‘burn’ in (87) below.

- (87) a. Báðar bækurnar **brunn-u**
 both books.the.NOM burn.IND.PST.INTR-PL
 ‘Both the books burned.’
- b. Báðar konurnar **brenn-d-u** bókina.
 both women.the burn.TR.IND-PST-PL book.the
 ‘Both the women burned the book.’

Various linguists have proposed that this morphology marks the presence or absence of a Voice head (Schäfer 2008, 2012, Pitteroff & Alexiadou 2012, Pitteroff 2014, 2015, Wurmbrand 2015) or the distinction between a transitive and unaccusative Voice head (Wood, 2015). Assuming as much, one might ask what kind of stem morphology is found in nominalizations, and whether it tells us anything about the presence or absence of a Voice head. However, it is not trivial to know what to expect here. The vowel shifts in question are affected also by verbal number, mood, tense, and aspect. Taking *brenna* ‘burn’ as an example, the transitive stem is always *brenn-*. The intransitive stem is also *brenn-* in the present tense, infinitive, and the present participle. The intransitive stem form only takes a different form as a past participle, where it is *brunn-*, and in the past tense, where it is *brann-* for singular indicative, *brunn-* for plural indicative, and *brynn-* for subjunctive. So it is not as simple as saying that the presence of Voice conditions one form and its absence another. To determine the stem form, one must know the tense, number, and mood the verb is embedded under (and/or whether it is embedded under participial structure).

⁴⁶ Note that Wood (2015) explicitly analyzed *-na* as a realization of Voice only because it allowed for a simpler formulation of the Vocabulary Item, not for any empirical reason.

So if we see a given form, it may not be clear if it is just conditioning one of the available forms, or Voice+n. Consider now a nominal like *brun-i* ‘burn’. The form of the root is one of the ‘intransitive’ ones, specifically the one that shows up in the past plural indicative. Most speakers I have asked find (88a) quite bad with the intended meaning, but accept (88b) (which was originally volunteered by Anton Karl Ingason).

- (88) a. ?? **brun-i** kvennanna á bókinni
 burn-NMLZ women.the.GEN on book.the
 ‘the women’s burning of the book’
 b. **brun-i** jeppans á eldsneyti
 burn-NMLZ jeep.the.GEN on fuel
 ‘the jeep’s burning of fuel’

For the verb, the *brun-* form only shows up in the intransitive. The fact that it shows up in the nominalization may suggest that unaccusative Voice can be present; or it might be the form that shows up when Voice is entirely absent. Or, it might say nothing about Voice at all, and simply be a form that the nominalizer conditions.

Note that another way to nominalize *brenna* is *brennsla*, with the much more productive nominalizer *-sla*. In this case, the form of the stem doesn’t say anything about the presence or absence of Voice one way or the other, since this form is present in both transitive and intransitive forms.⁴⁷

- (89) a. **brenn-sla** kvennanna á bókinni
 burn-NMLZ women.the.GEN on book.the.DAT
 ‘the women’s burning of the book’
 b. **brenn-sla-n** á bókinni
 burn-NMLZ-the on book.the.DAT
 ‘the burning of the book’

It is less than clear if the intransitive reading is available. Some speakers find, at the very least, that the transitive reading is much more salient, and perhaps the only reading available. However, some speakers report that the intransitive reading can be brought out in sentences like (90).⁴⁸

- (90) Ég horfði á **brenn-slu-na** á skóginum.
 I watched on burn-NMLZ-the.ACC on forest.the
 ‘I watched the burning of the forest.’

This difference manifests itself in the availability of *af hálfu* phrases, where most speakers find *af hálfu* more natural with *brennsla* than with *bruni*; and in fact, *bruni* is generally judged quite bad with *af hálfu*.

- (91) a. * **brun-i** ruslsins af hálfu Jóns
 burn-NMLZ trash.the.GEN by part Jón.GEN
 INTENDED: ‘the burning of the trash by Jón’
 b. ? **brenn-sla** ruslsins af hálfu Jóns
 burn-NMLZ trash.the.GEN by part Jón.GEN
 ‘the burning of the trash by Jón’

A similar contrast involves agentive contexts such as the following (where prohibiting something implies that an agent can choose to do something or not).

- (92) a. **Brenn-sla** á bókum er stranglega bönnuð
 burn-NMLZ on books is strictly prohibited
 ‘Burning of books is strictly prohibited.’
 b. ?? **Brun-i** á bókum er stranglega bannaður
 burn-NMLZ on books is strictly prohibited

⁴⁷ Some speakers, however, find this form to be more salient in the context of burning calories.

⁴⁸ Other speakers still report that (90) must mean that someone is agentively burning the forest.

The data overall seem to suggest that the agentive, CEN reading based on the verb is not really available with *bruni*, but is the more salient reading with *brennsla*.⁴⁹

My interpretation of this data is that *bruni* is in fact a root nominalization, and *brennsla* is derived from the verb. This explains the fact that the special meaning of ‘burn’ is needed for (what resembles) argument structure with *bruni*, as shown in (88) above. The argument structure is not inherited by the verb, but built directly on the root and the nominalizer; speakers vary as to what readings the complement may have, and the genitive is often read as a possessor (which, of course, can encompass a variety of relations). True agent readings, then, are quite limited, perhaps impossible with *bruni*. With *brennsla*, however, the nominal is built on the verb, and true agent readings are possible—and in fact the most salient. As discussed further in the next section, speakers vary with different verbs and nouns as to whether the unaccusative reading, agentive reading, or both are available.⁵⁰ Whatever the explanation is for this fact, it does not in itself entail that Voice is present in the nominalization of either *brennsla* or *bruni*, and there is no evidence from the morphological form in favor of there being a Voice head in the structure.

2.5.2 *Passive vs. Unaccusative Readings*

We have already seen with *rotma* ‘rot’ that unaccusative readings are available in principle. A related question is whether a nominalization of a verb that can be either transitive or unaccusative gets a passive or an unaccusative reading (Iordăchioaia, 2008; Alexiadou et al., 2009). Consider first the nominalization of the verb *opna(st)* ‘open’.

- (93) a. Guðrún opnaði hurðina.
Guðrún.NOM opened door.the.ACC
‘Guðrún opened the door.’
b. Hurðin opnaði-st.
door.the.ACC opened-ST
‘The door opened.’
- (94) skyndileg opn-un hurðarinnar
sudden open-NMLZ door.the.GEN
‘the sudden opening of the door’
a. ✓ Passive reading (implicit agent)
b. ✓ Unaccusative reading (door opens on its own)

As shown in (93), this verb can be transitive or unaccusative, and the unaccusative is marked with the *-st* morpheme. When it is nominalized, as shown in (94), it can refer either to the transitive/passive reading (with an implicit agent) or an unaccusative reading.

We find a similar situation with ‘explode’. As shown in (95), ‘explode’ can be transitive or intransitive, and there are different stem forms for each.

- (95) a. Einn tilræðismannanna [...] sprengdi bílinn þar.
one attackers.the.GEN exploded car.the.ACC there
‘One of the attackers blew up the car there.’⁵¹
b. Bílinn sprakk þar.
car.the.NOM exploded there
‘The car exploded there.’

However, both forms can be nominalized as *sprenging* ‘explosion’. At first blush, some speakers find that the passive reading is more natural, and have a hard time interpreting the sentences in (96) as describing an explosion that happened on its own. Other speakers consider both readings available.

⁴⁹ Oddur Snorrason (p.c.) doesn’t find that the sentences in (92) bring out the contrast for him, but other tests, such as purpose clauses, do make this contrast more salient.

⁵⁰ Possibly the existence of *bruni* leads to (a certain amount of) blocking of the unaccusative reading of *brennsla*. In the present theory, this would have to be blocking at the level of ‘use’ rather than grammar, in the sense discussed in Embick & Marantz (2008).

⁵¹ <http://www.ruv.is/frett/sjalfsmordsaras-a-knattspymuvelli>, Jan. 16, 2019

- (96) a. spreng-ing-in á bílnum
 explode-NMLZ-the on car.the
 ‘the explosion of the car’
 i. ✓ Passive reading (implicit agent)
 ii. % Unaccusative reading (car explodes on its own)
- b. spreng-ing bílsins
 explode-NMLZ car.the.GEN
 ‘the explosion of the car’
 i. ✓ Passive reading (implicit agent)
 ii. % Unaccusative reading (car explodes on its own)

However, this effect is likely a matter of salience rather than the unaccusative reading being ruled out by the grammar. This is because it is possible to say (97), where it is much less likely that there is an agent.⁵²

- (97) spreng-ing eldfjallsins
 explode-NMLZ volcano.GEN
 ‘the explosion of the volcano’
 a. ✓ Passive reading (implicit agent)
 b. ✓ Unaccusative reading (volcano explodes on its own)

Thus, either the passive or unaccusative reading is available in principle with *sprenging* ‘explosion’, but one or the other may be more salient for a particular example.

In both of the examples discussed so far, the causative alternation is marked morphologically (with *-st* and stem changes, respectively). In connection with this, it is worth noting that *stækka* ‘enlarge’ does not—both the transitive and intransitive take the same set of forms. When nominalized, *stækkun* ‘enlargement’ is ambiguous, and may have the transitive/passive reading or the unaccusative one.

- (98) a. Þau stæ-kk-uðu holuna.
 they large-KA-ed hole.the.ACC
 ‘They enlarged the hole.’
 b. Holan stæ-kk-aði.
 hole.the large-KA-ed
 ‘The hole enlarged / got bigger.’
- (99) stæ-kk-un holunnar
 large-KA-NMLZ hole.the.GEN
 ‘the enlargement of the hole’
 i. ✓ ‘Passive reading’ (implicit agent)
 ii. ✓ ‘Unaccusative reading’ (hole got bigger on its own)
- (100) stæ-kk-un-in á holunni
 large-KA-NMLZ-the on hole.the.GEN
 ‘the enlargement of the hole’
 i. ✓ ‘Passive reading’ (implicit agent)
 ii. ✓ ‘Unaccusative reading’ (hole got bigger on its own)

Note, however, that at least two speakers found the passive reading much more salient than the unaccusative reading in (100). Speakers generally found both readings available (99), although some find the passive reading more salient, others the unaccusative reading.

Alexiadou (2017a) takes the ambiguity in Greek to signal that Voice may be absent, and when it is, the ambiguity arises. Applying the same reasoning to Icelandic suggests that Voice may be absent in Icelandic as well. It is less clear, however, whether the transitive/passive reading entails the presence of Voice. What the data in this subsection show is that Voice can be absent in nominalizations; it is still an open question whether Voice is always absent or whether it is sometimes present.

⁵² This observation came in the context of a discussion of a result reading of *sprenging* which refers to volcanic eruptions. For this, however, one has to use a plural and an ‘in’ PP, as in *sprengingar í eldfjöllum* ‘lit. the eruptions in the volcano’.

2.5.3 Self-Action Reading

It has also been argued that the presence or absence of Voice can be diagnosed by the presence of a ‘self-action’ restriction (Kratzer, 2003; Iordăchioaia, 2008; Alexiadou et al., 2009, 2013; Alexiadou, 2017a). According to Alexiadou (2017a), English *ing-of* nominals have such a restriction, whereas *-ation* nominals do not.

- (101) a. The children were being registered.
 i. * Theme = Agent: The children registered themselves.
 ii. ✓ Theme ≠ Agent: The children were registered by someone.
 b. The report mentioned the painfully slow **registering** of the children.
 i. * Theme = Agent: The children registered themselves.
 ii. ✓ Theme ≠ Agent: The children were registered by someone.
 c. The report mentioned the painfully slow **registration** of the children.
 i. ✓ Theme = Agent: The children registered themselves.
 ii. ✓ Theme ≠ Agent: The children were registered by someone.

Like the passive/unaccusative ambiguity above, this fact suggests that English *-ation* nominals *may* lack VoiceP—either always, or they are ambiguous between VoiceP and vP. Icelandic seems to pattern like English *-ation* nominals in this respect.

- (102) Í skýrslunni var minnst á
 in report.the was mentioned on
 skelfilega hæggenga skrá-ning-u nemenda.
 painfully slow register-NMLZ-ACC students
 ‘The report mentioned the painfully slow registration of students.’
 a. ✓ Theme = Agent: The students registered themselves.
 b. ✓ Theme ≠ Agent: The students were registered by someone.

This data point suggests that Icelandic nominalizations may lack Voice, and is compatible with the idea that they always lack Voice.

2.5.4 Restrictions on the subject

English nominalizations are subject to the ‘direct participation effects’, so that indirect causers are not possible subjects (Harley & Noyer, 2000):

- (103) a. { The judge / adultery } separated Jim and Tammy Faye Bakker.
 b. { The judge’s / *adultery’s } separation of Jim and Tammy Faye Bakker.

Icelandic patterns like this as well. Although the agent reading is not perfect for all speakers, it is clearly a possible form, whereas the indirect causer ‘adultery’ is not.

- (104) a. { Dómarinn / framhjáald } aðskildi Brján og Maríu.
 { judge.the / adultery } separated Brján and María
 b. Aðskilnaður { ?dómarans / *framhjáaldsins } á Brjáni og Maríu.
 separation { ?judge.the.GEN / *adultery.the.GEN } on Brján and María
 ‘The { ? judge’s / *adultery’s } separation of Brján and María.’

For English *-ation* nominals, Alexiadou et al. (2013, 90fn13) suggest that the restriction stems from the fact that the English subject is a possessor and not an argument of Voice. If so, this suggests that in Icelandic, too, the genitive is not an argument of Voice, but is rather a possessor.

2.5.5 Agentive modifiers

One final consideration that has played a role in the question of the presence or absence of Voice in a given structure, including nominalizations, involves a variety of modifiers that target the agent semantically (Iordăchioaia 2008; Alexiadou 2009; Alexiadou et al. 2009; Bruening 2013). These modifiers include the following:

- Passive agent phrases
- Purpose clauses
- comitative PPs, instrument PPs
- manner/agent PPs
- *without* phrases
- Adverbs as in ‘their eating of the cake politely’

As mentioned earlier, agentive by-phrases are quite impossible in Icelandic.

- (105) a. eyðilegg-ing borgarinnar (*af óvininum)
destr-NMLZ city.the.GEN (*by enemy.the.DAT)
‘the city’s destruction by the enemy’
- b. eyðilegg-ing-in á borginni (*af óvininum)
destr-NMLZ-the on city.the.DAT (*by enemy.the.DAT)
‘the destruction of the city by the enemy’

However, it was also noted above that the agent can be introduced by an *af hálfu* phrases.

- (106) eyðilegg-ing borgarinnar af hálfu óvinnarinnar
destroy-NMLZ city.the.GEN by part enemy.GEN
‘the destruction of the city by the enemy’

One could argue that *af hálfu* phrases necessarily pick out the VoiceP layer. After all, they do require a sentient agent, and they are not compatible with nominals that do not take agentive external arguments.

- (107) a. *rot-n-un laufblaðanna af hálfu raka
rot-NA-NMLZ leaves.the.GEN from part humidity.GEN
- b. *rot-n-un laufblaðanna af hálfu garðyrkjumannsins
rot-NA-NMLZ leaves.the.GEN from part gardener.the.GEN

However, it is not clear why the more complex circumlocution is necessary in nominalizations but not verb phrases if the same projection is being targeted in both cases. The fact that ordinary by-phrases are impossible could be explained if Voice is absent in nominalizations, and Icelandic passive by-phrases really do need to attach to Voice. English would be different, then, in that its by-phrase is not so restrictive, and may attach to VoiceP or whatever nominal projection is responsible for introducing agents in nominals (e.g. PossP as suggested below).

Turning to purpose clauses, they are quite possible, as we saw earlier.

- (108) Söfn-un sýna til að skrásetja hvarf sveppagróðurs.
collect-NMLZ samples.GEN for to document disappearance mushrooms.GEN
‘The collection of samples to document the disappearance of mushrooms.’

However, this might be more diagnostic of an implicit argument, perhaps even an agentive one, without that argument necessarily being in or related to Voice. In my analysis in chapter 5, I will show how agentive semantics can be brought into the structure in a way that is similar to a Voice head, but without having an actual Voice head connected to a verb. Thus, some diagnostics might be connected not to Voice per se, but to external argument semantics.

Relatedly, Bruening (2013) also discusses comitative PPs, instrument PPs, manner/agent PPs, and *without*-phrases, all of which he takes to be diagnostic of a Voice projection. Some of his examples from English are presented below:

- (109) a. Darwin’s observation of finches with his assistant (comitative)
- b. the detection of the sound with an amplifier (instrument)

- c. the Republicans' recognition of that fact without really registering its significance (*without phrase*)

Icelandic seems to pattern like English in this respect, as shown in the following examples.

(110) Comitative

- a. athug-un Darwins á fuglunum með aðstoðamanni sínum
observe-NMLZ Darwin.GEN on birds.the with assistant REFL.POSS
'Darwin's observation of the birds with his assistant'
- b. söfn-un Darwins á sveppum með aðstoðamanni sínum
collect-NMLZ Darwin.GEN on mushrooms with assistant REFL.POSS
'Darwin's collection of mushrooms with his assistant'
- c. rannsókk-n málfræðingsins á hv-framburði með aðstoðamönnum sínum
investigate-NMLZ linguist.the.GEN on hv-pronunciation with assistants REFL.POSS
'the linguist's investigation of hv-pronunciation with his assistants'

(111) Instrument

- a. Viðgerð á bílum með vitlausum verkfærum er slæm hugmynd.
repair on cars with wrong tools.the is bad idea
'The repairing of cars with the wrong tools is a bad idea.'
- b. Viðgerð Guðrúnar á bílnum mínum með sleggju var mjög slæm hugmynd.
repair Guðrún.GEN on car.the my with sledge.hammer was very bad idea
'Guðrún's repairing of my car with a sledge hammer was a very bad idea.'

(112) 'Without'-phrase

- samþykki-i Repúblikana á staðreyndinni án þess að átta sig á mikilvæginu
accept-NMLZ Republicans.GEN on fact.the without it to recognize importance.the
'the Republicans' acceptance of the fact without recognizing its significance'

As above, however, I will suggest that this might actually relate more to external argument semantics than to the syntactic Voice position itself. I return to this issue in chapter 5.

Finally, some linguists, most notably Fu et al. (2001), have argued that English nominalizations allow adverbs, and claimed that this fact supports the presence of a VP inside nominalizations. At least some of the adverbs brought up are the agentive sort, such as 'politely', which would suggest a Voice layer as well. Some of these examples are reproduced below.

- (113) a. (While) the removal of evidence purposefully (is a crime),
the removal of evidence unintentionally (is not).
b. His transformation into a werewolf so rapidly was unnerving.

However, any adverbs of this sort are quite unthinkable in Icelandic, whether agentive or not.

- (114) a. algjör eyðilegg-ing þeirra á borginni
complete destroy-NMLZ their on city.the
'their complete destruction of the city'
- b. eyðilegg-ing þeirra á borginni (*algjörlega)
destroy-NMLZ their on city.the (*completely)
'their destruction of the city (*completely)'
- (115) a. át-Ø Jóns á kökuni (*kurteisislega)
eat-NMLZ Jón.GEN on cake.the (*politely)
'Jón's eating of the cake (*politely)'
- b. ummynd-un hans í varúlf (*svo skyndilega)
transform-NMLZ his in werewolf.ACC (*so suddenly)
'his transformation into a werewolf (*so suddenly)'

It is not clear why English and Icelandic seem to differ in this way. Even in English, such adverbs are quite marginal for many speakers, and rarely perfect; the corresponding adjective is invariably better. Given the other similarities between Icelandic and English, I would tentatively suggest that the contrast is related not to nominalizations per se, or the presence of Voice, but to the licensing of the adverbs themselves.⁵³ At any rate, Icelandic certainly provides no extra support for a Voice layer (or even a vP layer, as argued below) on the basis of adverbs.

2.5.6 Binomial Each

Bruening (2013) argues that binomial *each* requires a VP and VoiceP projection. Based on this, he argues that English deverbal nominals like *destruction* or *detection* contain a VoiceP.

- (116) a. the barbarians' destruction of two houses each
 b. the doctors' detection of two tumors each
 c. * the children's sense of two dangers each
 d. * the children's two kittens each

The binomial 'each' construction has not been well studied in Icelandic. However, Halldór Sigurðsson (p.c.) points out to me that it is not acceptable for him (and other speakers I have asked agree):

- (117) * eyðilegg-ing barbaranna á tveim(ur) húsum hver
 destroy-NMLZ barbarians.GEN on two houses each
 INTENDED: 'the barbarians' destruction of two houses each'

Whatever the status is of this diagnostic in English, we do not find any support for VoiceP structure inside nominalizations from binomial 'each' in Icelandic.

2.5.7 Summary of VoiceP Diagnostics

Overall, I conclude that there is little evidence in favor of a Voice head inside Icelandic nominalizations. The morphological evidence is inconclusive, there is positive evidence that Voice can be absent (the passive/unaccusative ambiguity, the self-action reading), and at least two arguments that Voice is generally absent (restrictions on the subject, impossibility of by-phrases). The best arguments in favor of Voice stem from the availability of agentive modifiers, as discussed in section 2.5.5. However, all of these seem to be targeting semantic agency, and will be argued in chapter 5 to be compatible with the absence of Voice, as long as there is some head introducing agency.

2.6 Summary

In this chapter I have taken a detailed look at the properties of Icelandic nominalizations in the context of a broad theoretical background. I have shown that they are in most ways very similar to English *-ation*-type nominals. There are a variety of overt nominalizers, like English *-ment*, *-ation*, *-al*, *-ance*, etc. More importantly, they have the general ambiguity between complex event, simple event, and referring nominal readings. The complex event nominals are similar enough to English that arguments pertaining to English should affect our analysis of Icelandic, and vice-versa. It seems highly unlikely that English and Icelandic would exhibit these properties for fundamentally different reasons. Finally, we saw clear evidence that Icelandic nominalizations may include a v head, and still get the ambiguity. However, we saw little reason to assume the presence of a Voice head. At best, Voice is optional, but in the absence of compelling evidence to the contrary, we will proceed with the assumption that Voice is generally not present inside nominalizations.

⁵³ Mark Norris (p.c.) informs me that there is a similar contrast in Estonian, where otherwise fully nP-like nominalizations license adverbs.

The next chapter will build on the conclusion that Icelandic nominalizations are like English nominalizations. There, I will present Icelandic-specific evidence against the view that complex event nominalizations are built on verb phrases. Instead, I will propose that nominalizations are built by combining heads together without any arguments. The structure proposed will be identical for all readings, accounting for the ambiguity in a fundamental way. In chapter 4, I provide further support for the complex heads analysis by looking at the locality conditions for conditioning allosemy on roots, with a focus on various patterns of prepositional prefixing. In chapters 5 and 6, I work out the details of how the ambiguity of derived nominals is analyzed in terms of contextual allosemy of roots and functional heads. Chapter 5 focuses on CENs and argument structure inheritance, while chapter 6 focuses on SENs, RNs, and idiosyncratic root meaning.

Chapter 3

Phrasal layering vs. complex heads

This chapter builds on the results from the previous chapter, starting with the conclusion that nominalizations contain at least a *v* head, but may or may not contain a voice head. It then compares two ways of accomplishing this. The first is to nominalize a verb directly at the head level, before the verb combines with anything. I call this the complex head analysis. The second is to nominalize a verb phrase, complete with its arguments. I call this the phrasal layering analysis. I show that Icelandic raises problems for the phrasal layering analysis that are not raised for the complex head analysis, and argue in favor of the latter.

3.1 Case (non-)inheritance supports complex heads

The first and primary problem discussed in this chapter involves case-marking patterns. I will show that under a phrasal layering analysis, we would expect Icelandic nominalizations to inherit case-marking patterns from their verbal sources, which they in fact do not. The primary focus will be on dative themes, because they are most distinctive of Icelandic (in contrast to related languages with rich case-marking systems) and given that themes can easily be inherited by nominalizations, they constitute the clearest example of the problem from case-marking. I will describe dative direct object themes first, and then dative subjects. I will then discuss some other non-canonical case frames, and show that they too cannot be inherited.

3.1.1 *Dative direct object themes*

Recall that the Parallel Structures analysis, where noun and verb are independently derived from the same, category-neutral root, faces the challenge that arguments are not really ‘optional’, and that argument structure seems to be inherited—obligatorily so, when event structure is inherited. Moreover, they face the problem that some nominalizations have overt realizations of *v*, indicating that they must have been derived from a verbal source. These problems hold for Icelandic just as much as for English, so we will set aside the Parallel Structures analysis for the time being.

The alternative has generally been some version of the Phrasal Layering analysis, where what is nominalized is a full verb phrase, with any number of functional projections above it. For example, the structure of a complex event nominal according to Alexiadou (2017b) is along the lines of (1) (although there she put the theme in SpecvP).

- (1)
- the collection of mushrooms*

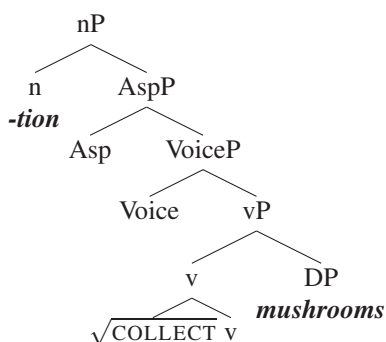

However, it is worth pointing out right away that a phrasal layering analysis need not necessarily involve all of the functional structure seen in (1). Alexiadou (2017a) argues that for CENs, *n* must attach at least as high as *vP* in order to inherit argument and event structure. When the agent is present, Voice will be in the structure as well. The minimally low attachment point, then, would involve a nominalizer on top of a *vP*, as in (2).

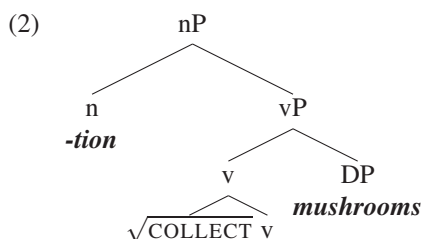

According to this analysis, we would expect certain case marking patterns to be inherited by a nominalization. In this section we first consider dative object themes. Consider NOM-DAT verbs like *bjarga* 'rescue' and *aka* 'drive'. Both of these verbs assign dative to the theme object.

- (3) a. Þau björguðu sjómanninum.
they.NOM rescued sailor.the.DAT
'They rescued the sailor.'
- b. Guðrún ók leigubílnum.
Guðrún.NOM drove taxi.the.DAT
'Guðrún drove the taxi.'

(4a–b) illustrate the well-known fact that this dative case is preserved under passivization, unlike the accusative case on accusative themes.

- (4) a. Sjómanninum var bjargað (af þeim).
sailor.the.NOM was rescued (by them)
'The sailor was rescued (by them).'
- b. Leigubílnum var ekið (af Guðrúnu).
taxi.the.DAT was driven (by Guðrún)
'The taxi was driven by Guðrún.'

Since assignment of dative to a theme is at least somewhat lexically idiosyncratic (see discussion below), the vast majority of researchers put the feature leading to dative case on direct objects within the verb phrase domain, on either *v* or Voice (if not the lexical verb root itself). (See, for example, Svenonius 2002, 2005, 2006; H.Á. Sigurðsson 2012b; Jónsson 2013b; Alexiadou et al. 2014a; Wood 2015 for *v*; and Schäfer 2008 and E.F. Sigurðsson 2017, 54 for Voice.) Thus, the structure of the verb phrase, up to VoiceP, is uncontroversially something like (5).

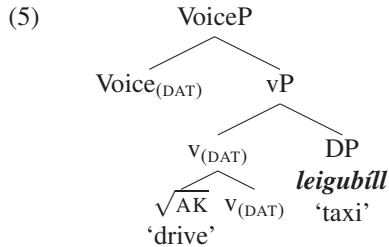

Putting the dative feature this low means that further operations, such as attaching a passive head on top of VoiceP, or entering into the Agree-domain of T, will have no effect on the case-marking. Case-marking is determined low, and maintained for the rest of the derivation.

Turning to nominalizations, we can now see that the Phrasal Layering analysis, all of the vP-internal material needed to determine dative case is present.

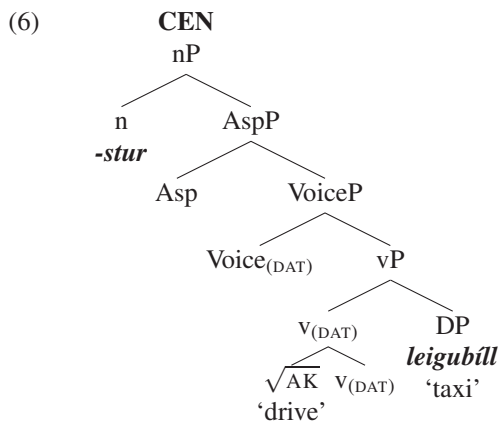

The nominalizer attaches on top of AspP, above VoiceP, and would not generally be expected to override the assignment of dative. Instead, we would expect to find dative on the theme of a noun derived from a dative-assigning verb.

This is not what we find: the thematic argument of such verbs can be inherited, as shown by Maling (2001), but it cannot be dative. What we find is that nominalizations seem to take the same set of forms no matter what the source verb's case frame would be. This is shown in (7) and (8) for nominalizations of *bjarga* 'rescue' and *aka* 'drive', respectively.

- (7) a. *björg-un sjómannsins*
rescue-NMLZ sailor.the.GEN
'the rescue of the sailor'
- b. * *björg-un sjómanninum*
rescue-NMLZ sailor.the.DAT
INTENDED: 'the rescue of the sailor'
- (8) a. *ak-stur leigubílsins*
drive-NMLZ taxi.the.GEN
'the driving of the taxi'
- b. *ak-stur Guðrúnar á leigubílnum*
drive-NMLZ Guðrún.GEN on taxi.the.DAT
'Guðrún's driving of the taxi.'
- c. * *ak-stur leigubílnum*
drive-NMLZ taxi.the.DAT
INTENDED: 'the driving of the taxi'

(9) shows another example, from Jóhannsdóttir (1995), with the verb *loka* 'close'; (9c) is added here.

- (9) Lögreglan lokaði spilavítinu.
 police.the.NOM closed casino.the.DAT
 ‘The police closed down the casino.’
- a. Lok-un spilavítisins vakti deilur manna.
 close-NMLZ casino.the.GEN woke arguments people.GEN
 ‘The closing of the casino made people argue.’
- b. Lok-un-in á spilavítinu vakti deilur manna.
 close-NMLZ-the on casino.the.DAT woke arguments people.GEN
 ‘The closing of the casino made people argue.’ (Jóhannsdóttir, 1995, 72)
- c. * Lok-un(-in) spilavítinu vakti deilur manna.
 close-NMLZ casino.the.DAT woke arguments people.GEN

One might be tempted to take these examples to suggest a return to the Parallel Structures analysis, where the nominalizations are built not on verbs, but on roots. The example in (10), however, speaks against this. There, we see an overt verbalizer, *-ga*, which is contained in the nominal. This example is transparently built on the verb, and not a category neutral root.

- (10) Addamshjónin fjöl-g-uðu börnunum.
 the.addamses.NOM increase-VBLZ-PST children.the.DAT
 ‘The Addamses had more children.’
- a. Fjöl-g-un barnanna vakti athygli.
 increase-VBLZ-NMLZ children.the.GEN drew attention
 ‘The increasing of the children drew attention.’
- b. Fjöl-g-un-in á börnunum vakti athygli.
 increase-VBLZ-NMLZ-the on children.the.DAT drew attention
 ‘The increasing of the children drew attention.’ (Jóhannsdóttir, 1995, 72)
- c. * Fjöl-g-un börnunum vakti athygli.
 increase-VBLZ-NMLZ children.the.DAT drew attention

Further examples from Maling (2001, 449) are given in (11)–(17), where in each case we see a verb that assigns dative to its argument, and its corresponding nominalization instead assigns genitive to that same argument.¹

- (11) a. Ég breytti fundartímanum.
 I.NOM changed meeting.time.the.DAT
 ‘I changed the time of the meeting.’
- b. breyt-ing fundartímans
 change-NMLZ meeting.time.the.GEN
 ‘the changing of the time of the meeting’
- (12) a. Hann eyddi skjalinu óvart.
 he.NOM deleted file.the.DAT accidentally
 ‘He accidentally deleted the file.’
- b. eyð-ing skjalsins
 delete-NMLZ file.the.GEN
 ‘the deletion of the file’
- (13) a. Hann frestaði fundinum.
 he postponed meeting.the.DAT
 ‘He postponed the meeting.’
- b. frest-un fundarins
 postpone-NMLZ meeting.the.GEN
 ‘the postponement of the meeting’
- (14) a. Hún lokaði versluninni kl. 9.
 she.NOM closed store.the.DAT 9 o’clock
 ‘She closed the store at 9 o’clock.’
- b. lok-un verslunarinnar
 close-NMLZ store.the.GEN
 ‘the closing of the store’

¹ Maling (2001) points out that for some dative objects, a preposition is needed to introduce the relevant meaning in a nominal; this holds for German dative objects in general, and Icelandic dative objects when the dative argument is a goal, rather than a theme. What makes Icelandic especially useful here is that Icelandic has dative direct objects that are themes in a way that many other languages do not. I discuss the role of the preposition in introducing arguments in nominalizations in detail in chapter 4.

- (15) a. Þeir úthluta verðlaununum eftir mótið.
they distribute prizes.the.DAT after meeting.the
'They distribute the prizes after the meeting.'
- b. úthlut-un verðlaunanna
distribute-NMLZ prizes.the.GEN
'the distribution of the prizes'
- (16) a. Íslendingar útrýmdu geirfuglinum.
Icelanders exterminated the.great.auk.DAT
'Icelanders exterminated the great auk.'
- b. útrým-ing geirfuglsins
exterminate-NMLZ the.great.auk.GEN
'the extermination of the great auk'
- (17) a. Þeir útskúfuðu morðingjanum.
they.NOM banished murderer.the.DAT
'They banished the murderer.'
- b. útskúf-un morðingjans
banish-NMLZ murderer.the.GEN
'the banishment of the murderer'

This is a general problem for a Phrasal Layering analysis. Even if *n* Case-licenses the object, this is considered a *structural case*; it would not be expected to manifest as genitive if dative had already been determined. Dative on direct objects is retained in passives, so the presence of passive Voice would not make a difference to the morphological case properties.²

Lack of case inheritance follows on the present proposal: there are no arguments within the domain of verbal heads that would determine case marking. Even if the DAT-assigning feature is on *v*, there are no DPs local enough to it to receive dative case.

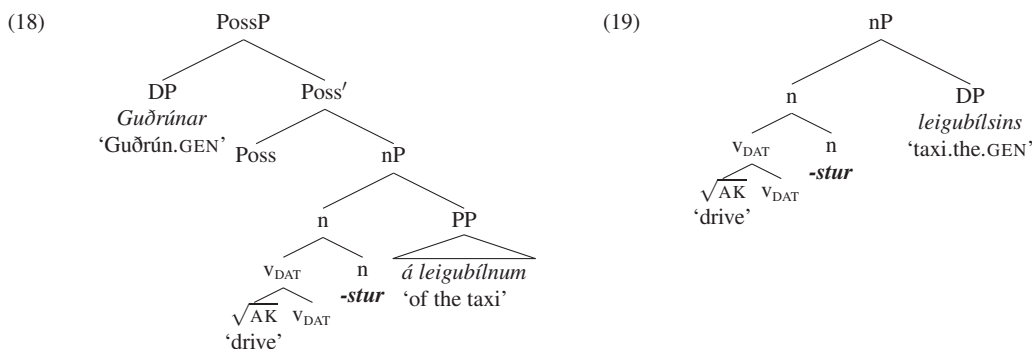

Instead, the DPs involved are arguments of the nP, and are therefore marked however arguments of nP are marked, such as with genitive case or within a PP.

3.1.2 Dative themes of unaccusatives

As mentioned above, some analyses of Icelandic case-marking take dative direct objects to be assigned dative by a special Voice head, rather than a *v* head (Schäfer 2008; E.F. Sigurðsson 2017, 54). If this is always the case, the data above might be interpreted as a showing that nominalizations lack a Voice layer, a proposal with independent plausibility, as we have seen. This would mean that the reason that dative is not retained although argument structure is inherited stems from the absence of the dative-assigning Voice head in nominalizations.

However, if the proposal that dative is assigned by Voice is correct for some cases, it cannot be right for all cases. To see why, it is worth discussing what motivated the placement of the dative feature on Voice to begin with. The proposal stems from work by Svenonius (2001, 2002, 2005, 2006), drawing on generalizations by Maling (2001, 2002a,b), and the idea is that the licensing of the dative object connects directly to the way that the external argument is involved in the event. Consider the examples with *moka* 'shovel' in (20).

- (20) a. Guðrún mokaði tröppurnar.
Guðrún.NOM shoveled steps.the.ACC
'Guðrún shoveled the steps.'
- b. Guðrún mokaði snjónum.
Guðrún.NOM shoveled snow.the.DAT
'Guðrún shoveled the snow.'

² See Ingason (2016, 71) for a related point about non-inheritance of case-marking patterns by nominals, with a different nominal construction.

Here, we see that *moka* ‘shovel’ assigns accusative when the theme is *tröppurnar* ‘the steps’, but dative when the theme is *snjónum* ‘the snow’. I note in passing that either of these kinds of arguments can occur as the genitive in nominals, as shown by the following attested examples.³

- (21) Þrjátíu björgunarsveitarmenn unnu við mok-stur snjós út úr húsunum.
 thirty rescue.team.workers worked with shovel-NMLZ snow.GEN out out.of house.the.DAT
 ‘Thirty rescue team workers worked on the shoveling of snow out of the house.’⁴
- (22) Verklagsreglur í tengslum við mok-stur gatna og sölt-un verða því yfirfarnar...
 procedure.rules regarding shovel-NMLZ streets.GEN and salt-NMLZ will.be thus reviewed
 ‘The procedural rules in connection with the shoveling and salting of streets will therefore be reviewed...’⁵

Why does *moka* ‘shovel’ assign dative sometimes and accusative other times? The idea is that dative is assigned when the event continues without the external argument being involved. That is, the external argument is only involved in the initiating subevent. So, for example, when Guðrún stops moving, the steps instantly stop being involved in the shoveling, so the steps are accusative. However, even when Guðrún stops moving, the snow may continue flying through the air, so the snow is dative. Since the generalization about the dative object involves properties of the external argument, so the reasoning goes, the dative feature should be on Voice, which introduces this special kind of external argument.

There are a number of problems with encoding such a generalization directly into the grammar, most of which will not concern us here. See Jónsson (2010, 2013a,b) and Wood (2015, 137–138) for some discussion. What is particularly relevant for present purposes is that dative can also be assigned to internal arguments of unaccusatives with no external argument at all, and such arguments can still be genitive in nominalizations.⁶ Consider the examples in (23)–(26).

- (23) a. **Meningunni** hefur hnig-na-ð.
 culture.the.DAT has declined-VBLZ-PTCP
 ‘The culture has declined.’
- b. hnig-n-un **menningarinnar**
 decline-VBLZ-NMLZ culture.the.GEN
 ‘the decline of the culture’
- (24) a. **Vélinni** sein-ka-ði.
 plane.the.DAT late-VBLZ-PST
 ‘The plane delayed.’
- b. sein-k-un **vélarinnar**
 delay-VBLZ-NMLZ plane.the.GEN
 ‘the delay of the plane’
- (25) a. **Íbúum** Reykjavíkur hefur fjöl-ga-ð.
 residents.DAT Reykjavík.GEN has increase-VBLZ-PTCP
 ‘The population of Reykjavík has increased.’
- b. fjöl-g-un **íbúa** Reykjavíkur
 increase-VBLZ-NMLZ residents.GEN Reykjavík.GEN
 ‘increase of the population of Reykjavík’
- (26) a. **Sjúklingum** hefur fæ-kka-ð á þessu sjúkrahúsi.
 patients.DAT have decrease-VBLZ-PTCP at this hospital
 ‘The number of patients has decreased at this hospital.’
- b. fæ-kk-un **sjúklinga** (á þessu sjúkrahúsi)
 decrease-VBLZ-NMLZ patients.GEN (at this hospital)
 ‘the decrease of patients (at this hospital)’

³ One also finds both as the nonheads of synthetic compounds, as in *snjómokstur* ‘snow-shoveling’ and *götumokstur* ‘street-shoveling’.

⁴ <http://www.visir.is/g/2005501040411>, Jan. 24, 2019

⁵ <https://www.kopavogsbladid.is/yfirfara-verklagsreglur-vegna-snjomoksturs/>

⁶ The example in (24b) comes from Maling (2001, 449).

Dative in the (a) examples cannot be attributed to a dative feature on Voice. Either there is no Voice present, or if it is, it would be a defective, expletive Voice that has no external argument semantics. Certainly, one cannot, in these examples, point to a special initiator involved only in the initiating subevent to explain dative case on these themes; as far as can be told, there is no initiator here. The example in (23) with *hnigna* ‘decline’ is particularly telling, since it is marked with the *-na* morpheme, which only shows up in the absence of an external argument, possibly in the absence of any Voice head. So the *-na* morphology tells us that *v* is there, but Voice (or its argument) is not.⁷ This means that the feature must be on *v* or lower.⁸ Despite this, it can assign dative as a verb, but not as a derived noun.

Moreover, the cases above all have overt verbalizing morphology, such as with *-ka*, *-ga* and *-na*.

(27) *sein-k-un* ‘delay’

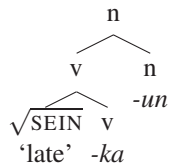

(29) *hnig-n-un* ‘decline’

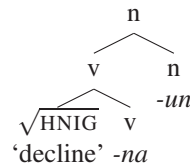

(28) *fföl-g-un* ‘increase’

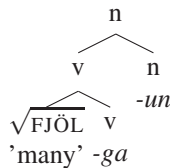

(30) *fæ-kk-un* ‘decrease’

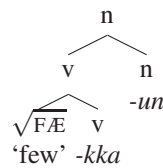

This means that we cannot try to account for the above data by arguing that they are really root-attaching nominals (and thus irrelevant to the question of case-inheritance). They are overtly derived from the *verbal* form, so from a layering perspective, there must be at least a vP (cf. Harley 2009b; Alexiadou 2009).

(31) **Phrasal Layering Analysis, vP only**

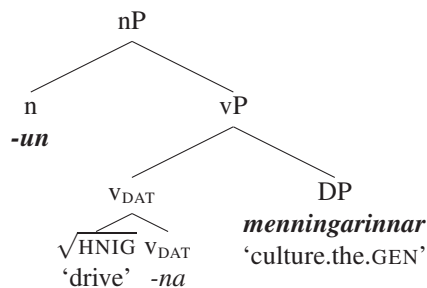

However, this should be enough to assign dative, which, as we have seen, is in fact not possible. Again, the present account does not face this problem, even if *v* does have a dative-assigning feature. Either the genitive is the complement of *n* or it is in SpecPossP.

⁷ Thus, one cannot, for this verb, try to posit a silent external argument responsible for the event, as is sometimes done for accusative subject constructions (Haider, 2001; Platzack, 2006; Schäfer, 2008, 2012; Wood, 2017); the morphology is telling us that there is no external argument there, and this is different from accusative subject constructions (Wood, 2017).

⁸ It could, in principle, be connected to the root or the structure of the complement. I will assume that the feature is on *v*, for the reasons discussed in Wood (2015, 135–138).

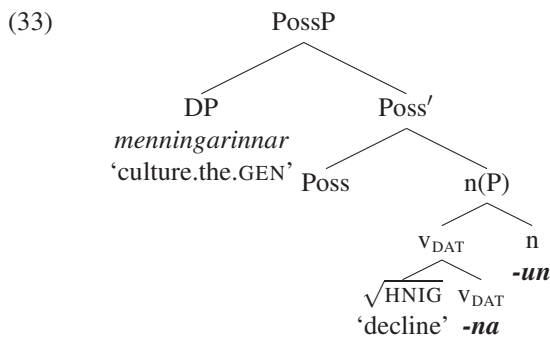
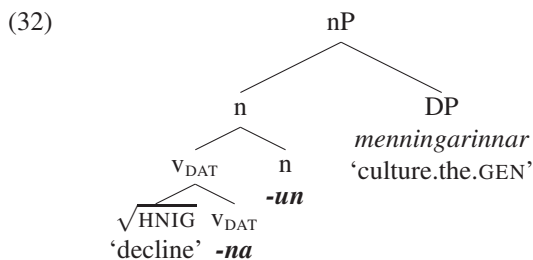

Either way, the DP is too far away from the dative *v* to be assigned dative.

3.1.3 On DP-internal datives

One possible response to the empirical facts above might be to lay the blame on the licensing of dative case. One might think that for some principled reason, dative DPs are generally not possible inside nPs. It is therefore worth pointing out, as discussed in more detail in section 1.4.3, that there are some constructions showing that this is not the case in general. Certain kinds of body-part possession can be expressed with an nP-internal dative, as in the slogan of the coffee shop Kaffitár.

- (34) Leggur heiminn að vörum þér.
 puts world.the.ACC to lips you.DAT
 ‘Puts the world to your lips.’

This kind of DP-internal dative is only possible when the DP is contained within a PP. However, it does show that there is no general ban on dative case inside a DP.⁹

Ingason (2016) discusses another construction where a dative DP appears inside an nP. This construction is presented in (35).

- (35) Þeir dönsuðu til skemmt-un-ar stelpunum.
 they danced for entertain-NMLZ-GEN girls.the.DAT
 ‘They danced for the girls’ entertainment.’

Ingason (2016, 82) argues that this construction is distinct from the dative possessor construction above, but shows that the dative DP in (35) is internal to the nP. He also argues that the dative is not inherited from any verb (despite the fact that this construction is very frequently based on nominalized verbs), nor is it assigned or licensed by the preposition *til* ‘for’. This shows that if some aspect of a construction assigns dative to a DP, there is nothing in principle stopping that DP from realizing its dative case nP-internally.

One could stipulate that the dative feature of the *v* head is deleted by impoverishment in the context of an *n* head. Such an impoverishment rule is in fact motivated for *-st* anticausatives in the verbal domain (Wood 2015). Then one could take the genitive to be the unmarked ‘elsewhere’ case inside an nP. However, this alternative has no independent motivation, and it would not be able to extend to the other case frames discussed in section 3.1.5, and it would also not help with the problem of *á*-PPs discussed in section 3.2.1.¹⁰ The independent motivation for assuming such an impoverishment rule in the case of verbs comes from the cases where it does not apply—datives that are not licensed by *v*. But as we will see in section 3.1.5, even these fail to realize their dative case in nominalizations, so one would have to posit a series of unrelated morphological rules, which all have the effect of removing any morphological evidence that there is a verb phrase inside nominalizations.

⁹ Ingason (2016) points out that although many examples of this construction sound poetic or bookish, “they are nevertheless common enough to have a fairly robust status in the modern grammar” (Ingason, 2016, 82).

¹⁰ In fact, it would only sharpen the problem with *á*-PPs. If the default realization of a caseless DP inside an nP is genitive case, then it only underlines the implausibility of any sort of “*á*-insertion” rule.

3.1.4 Icelandic datives are not low unmarked datives

A reviewer raises another possibility, which is that dative could be considered a low “vP unmarked” case, in the sense of Baker (2015). By way of background, Baker (2015), developing the dependent case system proposed by Marantz (1991/2000), observes that some case marking falls under what Marantz calls “environment sensitive unmarked case”. For example, if a DP is contained in another DP, and no other case is assigned to it, that DP will be assigned genitive. If a DP is contained in a TP, and no other case is assigned to it, that DP will be assigned nominative. In these situations, genitive and nominative are unmarked cases, but the choice between genitive and nominative is sensitive to the syntactic environment. Baker (2015) proposes that in some situations, there can be a special unmarked case assigned in the context of a vP; he analyzes Partitive case in Finnish in this way, which appears in both transitive and unaccusative configurations. This raises the possibility that dative case in Icelandic is a vP unmarked case, perhaps making it unsurprising that it is genitive and not dative that appears in nominalization, since genitive is the unmarked nominal case.

There are several reasons why this alternative will not work. First, dative cannot be an unmarked vP case in Icelandic. Icelandic has NOM-DAT-DAT ditransitives, with two dative objects, alongside the more common NOM-DAT-ACC ditransitives. One would not expect two unmarked datives in a vP—one should be a “dependent” case. Second, and more importantly, dative and accusative direct objects have exactly the same syntactic distribution, so there is no reason that the unmarked vP dative case would appear with some verbs and not with others. Datives are not lower, or inside the vP in any way that accusatives are not. This also holds for mono-transitives: direct object datives and direct object accusatives have the exact same distribution (Collins & Thráinsson, 1996; Jónsson, 1996; Svenonius, 2001, 2002; Thráinsson, 2007). Third, datives can undergo Object Shift or move out of the vP into SpecTP, so they would have to retain their “unmarked dative” status even as they move into another unmarked domain. But if that is how it works, we would expect the same thing in nominalizations—if the unmarked nominative of the TP domain does not override the unmarked dative of the vP domain, then the unmarked genitive of the DP domain should not do so either. Finally, if dative is a vP unmarked case, then a phrasal layering analysis would still predict dative to appear in nominalizations, because the *most local* environment of the relevant argument would be the vP, not the nP. If higher unmarked domains could reach into lower unmarked domains, then we would almost never end up with unmarked genitive in DP environment, since DPs are almost always going to be contained within another unmarked domain, such as TP or vP.

No matter how one looks at it, the fact of the matter is that certain verbs in Icelandic assign dative to their direct object, and this occurs inside the vP. We would not expect higher structure to override this case assignment/determination, and all of the structure necessary for dative case assignment would be present in a phrasal layering analysis. We also see from other languages, where there is independent evidence for a phrasal layering analysis, that dative case can be retained (see section 3.1.6 on Lithuanian). The evidence points clearly to the conclusion that there is no vP in Icelandic nominalizations, even under the Complex Event reading, which means that there is another way to form them.

3.1.5 Other case frames

The previous sections showed that verbs with dative themes can be nominalized, and their theme argument is inherited, but the dative case is lost. This is the most empirically robust domain showing non-inheritance of case, because themes are so robustly inherited as arguments of nominalizations. However, it is important to point out that it is not just dative theme verbs that do not pass their case properties on to the nominal. In fact, verbal case information, robust as it is in Icelandic, is never inherited by the deverbal nominal.

First, consider verbs like *afla* ‘procure’, which take genitive direct objects. These are in many ways the most similar to dative direct objects structurally. Just as dative objects are arguably licensed by a diacritic DAT feature on little *v*, so are genitive objects arguably licensed by a diacritic GEN feature. Both can be the second object in a ditransitive as well, suggesting that they are both direct objects. When they are nominalized, there is no sign of the nominal inheriting the case pattern. Consider the examples in (36).

- (36) a. Við öfluðum upplýsinga.
we procured information.GEN
'We procured information.'
- b. öfl-un upplýsinga
procure-NMLZ information.GEN
'procurement of information'
- c. öfl-un á { upplýsingum / *upplýsinga }
procure-NMLZ on { information.DAT / *information.GEN }
'procurement of information'

Admittedly, it is harder to show that the case patterns are not inherited, since genitive appears in both (36a) and (36b). But this is clearly consistent with the general fact that nominalizations may take genitive objects. We see in (36c) that the genitive case cannot occur when an *á*-PP is used; there, the same dative must be used that is used in all such cases, regardless of case pattern found in verb phrases headed by the underlying verb. This is not necessarily self-evident, as further discussed in section 4.4. Some attested examples illustrating this pattern are shown below in (37) (for *á*-PP complements) and (38) (for genitive complements).¹¹

- (37) Meginástæðan fyrir öflun á veðurupplýsingum...
main.reason.the for procurement on weather.information
'The main reason for the procurement of information about the weather...'¹²
- (38) Mörkin milli löglegrar og ólöglegrar öflunar upplýsinga...
line.the between legal and illegal procurement information.GEN...
'The line between legal and illegal procurement of information...'

Outside of the domain of direct objects, we turn to verbs which take subjects in cases other than nominative. One challenge in this area is that many such verbs are psych-verbs, and cross-linguistically, psych-verbs do not form nominalizations as readily as, say, dynamic change-of-state verbs. In fact, many Icelandic verbs with non-nominative subjects do not seem to be possible to nominalize at all, at least not in a clear, verb-derived way that preserves their verbal meaning.¹³ Iordăchioaia (2019c) thus argues that psych-nominals can only be root-derived, and not verb-derived, though Rozwadowska (2020) provides an analysis of Polish which suggests that at least some psych-nominals can be derived from verbs. For the sake of argument, I will assume in this section that the nouns in this section are verb derived, since they seem to inherit the meaning of the verb. However, if it turns out that all such cases are root derived, and there truly is a systematic ban on nominalizing these verbs, then the broad import of this section is only slightly reduced: either way, what this section shows is that for every situation where we might look for evidence that verbal case patterns can be inherited by nominalizations, we do not find them. I am suggesting that this is because there is no verb phrase, but it could also be true if there isn't even a verb.

To begin, consider the verb *vanta* 'need', which takes an accusative subject and an accusative object. When this verb is nominalized, however, we see the same pattern that we saw above: the derived nominal can take a genitive and/or an *á*-PP corresponding to its verbal arguments.

- (39) Fyrirtækið vantaði gott starfsfólk.
company.the.ACC needed good employees.ACC
'The company needed good employees.'

¹¹ The example in (38) comes from the RMH corpus.

¹² <https://www.vedur.is/um-vi/frettir/nr/873>

¹³ One may wonder why this is, a question that I will not answer here. However, I will note that it is probably connected the structural similarities between ditransitives and many psych-verb configurations. In the analysis of nominalizations in this book, the more restricted nature of nP syntax means that when a noun is derived from a verb, the structure that can then be projected essentially looks like a simple vP, with one complement, possibly with one external argument. vPs allow more structures: more complement types (such as small clauses) and more argument-introducing heads (such as applicative heads). Marantz (2013c, 164) states that "There's an important sense in which the expression of psychological states is not a good or easy match for the universal structure/meaning correspondences of argument structure and thus languages exploit many options for the psychological predicates, leading to variability in expression of the 'same' meanings cross-linguistically." In short, noun phrases offer fewer structural options for expressing psychological states.

- a. vönt-un góðs starfsfólks
need-NMLZ good employees.GEN
'the need of good employees' (ambiguous)
- b. vönt-un fyrirtækisins á góðu starfsfólki
need-NMLZ company.the.GEN on good employees.DAT
'the company's need of good employees'

Note that as above, the genitive can correspond to the subject or the object, with the subject reading being unambiguous if the object is expressed as an *á*-PP. We find the same pattern for other accusative-subject verbs like *skorta* 'lack/need' and *langa* 'want', which are nominalized as *skortur* and *löngun*, respectively.

As above, all analyses of accusative subject verbs have the accusative status of the subject determined within the VoiceP domain. If a nominalizer attached on top of VoiceP, we would expect accusative-accusative to be inherited, contrary to fact. If a nominalizer attached lower than VoiceP, such as on vP, at least one analysis, that of Wood (2017), would make a different prediction. There, it is claimed that both accusatives are in fact structural, and conditioned under Dependent Case theory by the presence of a silent external argument clitic in SpecVoiceP. Under that analysis, depending on our other assumptions, nominalizing on vP but not VoiceP would lead us to expect either NOM-ACC, GEN-GEN, or perhaps even some combination of NOM-GEN, GEN-ACC, etc. (depending on what the rules are for 'elsewhere' genitive inside a noun phrase). However, none of these patterns are possible. The best we could do is try to say that you end up with GEN-GEN, but that is ruled out for morphological reasons, so you insert *á* on the second argument, and (re)assign it dative. This is clumsy at best, and the *á*-insertion rule is problematic, as discussed below. Probably even more problematic is the fact that it gets a special status in this construction, as a kind of morphological repair, which is not motivated for *á*-PPs elsewhere, as discussed below.

Another problem for the phrasal layering analysis concerns the readings available in (39a), where there is only one genitive. There we see that the genitive can correspond to the experiencer without the stimulus being present. But in the case of the verb, this is quite impossible. The verb *vanta* can take one or two accusative arguments, but when it takes one, the meaning is 'lack' and the argument is not an experiencer.

- (40) a. Guðrúnu vantaði gott starfsfólk.
Guðrún.ACC needed good employees.ACC
'Guðrún needed good employees.'
- b. Starfsfólkið vantaði.
employees.the.ACC lacked
'The employees were missing/absent/lacking.'
≠ 'The employees felt a need.'

If the nominalizer attached on top of a vP, we would expect that the 'theme'-like argument (or stimulus) would always be present, with the experiencer being optional. We would not expect the experiencer to be present without the 'theme'-like argument (or stimulus). In the present analysis, the range of meanings available for the genitive will stem from the general interpretation options for genitive possessors and/or complements of the noun.

We find a similar set of issues, which manifest slightly differently in the details, with dative-nominative verbs like *misheyrast* 'mishear'. When this verb is nominalized, as above, we see the same, general nominalization pattern: the derived nominal can take a genitive and/or an *á*-PP corresponding to its verbal arguments.

- (41) Þér hafa víst misheyr-st orð mín!
you.DAT have surely misheard-ST words my
'You have surely misheard my words!'
- a. Misheyr-n Jóns olli vandræðum.
mishear-NMLZ Jón.GEN caused problems
'Jón's mishearing caused problems'
- b. Misheyr-n Jóns á orðum mínum olli vandræðum.
mishear-NMLZ Jón.GEN on words my caused problems
'Jón's mishearing of my words caused problems'

The experiencer can be expressed in *misheyrn* as a genitive, and the stimulus can be expressed as an *á*-PP. The same pattern can be found with *vanþóknast* ‘dislike/displease’.¹⁴

- (42) a. María vanþóknaðist Guðrúnu.
María.NOM displeased Guðrún.DAT
‘María displeased Guðrún.’
- b. Guðrún hefur vanþókn-un á Maríu.
Guðrún.NOM has displease-NMLZ on María.DAT
‘Guðrún has a dislike of María.’
- c. vanþókn-un Guðrúnar á Maríu
displease-NMLZ Guðrún.GEN on María.DAT
‘Guðrún’s dislike of María’

As above, every analysis of dative-nominative verbs has the dative case determined internal to the VoiceP, usually internal to the vP. Although some treat the nominative as being lexically selected as well, there are very good reasons to treat the nominative as a structural, elsewhere case (Wood & H.Á. Sigurðsson, 2014). Most frequently, the dative experiencer is considered the specifier of an Appl head (McFadden, 2004; H.Á. Sigurðsson, 2012b; Wood & H.Á. Sigurðsson, 2014; Wood, 2015; Ingason, 2016; E.F. Sigurðsson, 2017), and Wood (2015) argues that it is a low Appl head. If a nominalizer attached on top of VoiceP or vP, one would expect the dative case to be inherited, and the nominative to either show up as nominative or as genitive. This is, as we see, not what happens.

It is important to recognize that the dative here is not assigned by a dative v, so any explanation of the dative theme facts connected to dative v would not apply here. This is shown by the fact that in the verbal domain, *misheyrast* ‘mishear’ is an *-st* verb, and as discussed in the previous subsection, *-st* triggers deletion of the dative feature on v. The fact that the dative case survives here shows (and was in fact one of the motivating facts to show) that this dative is not assigned by v, and *-st* does not trigger deletion of the dative-assigning property of Appl. So if we are to assume a deletion of this kind for nominals, it would have to be a separate rule.

But even if we assume such a rule, we run into problems. First, we would have to explain why the experiencer could not be expressed as an *á*-PP. As explained elsewhere, the phrasal analysis really requires this as a general option. Instead, only genitive is possible.

- (43) a. Misheyr-n Guðrúnar (olli vandræðum).
mishear-NMLZ Guðrún.GEN (caused problems)
‘Guðrún’s mishearing caused problems.’
- b. * Misheyr-n-in á Guðrúnu (olli vandræðum).
mishear-NMLZ-the on Guðrún.DAT (caused problems)
INTENDED: ‘Guðrún’s mishearing caused problems.’

Second, we would have to explain why the *á*-PP is the only natural option for the stimulus: the genitive is quite marked, though perhaps not fully out, as the thing that is misheard.

- (44) a. ?? Misheyr-n orða minna (olli vandræðum)
mishear-NMLZ words.GEN my.GEN (caused problems)
INTENDED: ‘The mishearing of my words caused problems.’
- b. Misheyr-n-in á orðum mínum (olli vandræðum)
mishear-NMLZ-the on words.DAT my.DAT (caused problems)
‘The mishearing of my words caused problems.’

If the genitive is the default elsewhere case, then under any analysis of the nominative we expect it to be able to be genitive in the nominalization; but it cannot be.

One might try to account for *misheyrn* by assuming that the dative is introduced in an ApplP, and perhaps Appl is not possible inside nominalizations. The claim would then be that the experiencer is in fact not inherited by the nominalization, and the apparent experiencer is really a possessor. It can only be genitive, and not an *á*-PP, because

¹⁴ With this verb, the nominative is frequently the subject, but I take the underlying argument structure to be the same as a dative-nominative verb like *mislika* ‘dislike’. See Wood & H.Á. Sigurðsson (2014).

á-PPs are not introduced as possessors. However, it is not clear why, theoretically, an ApplP inside a vP would be disallowed in a nominalization. Moreover, it is not obvious that there is a total ban on Appl datives in nPs to begin with. Ingason (2016) argues that there is a systematic construction in Icelandic that involves an nP-internal ApplP. He shows that this ApplP is not inherited from any verbal construction. His analysis then suggests that there is not any outright ban on ApplP datives inside nPs, so it is a mystery why inheritance of Appl dative should be impossible on the phrasal layering analysis. Moreover, a ban on inheriting vPs containing Appl would only account for the experiencer. The stimulus is clearly a possible inherited argument, as shown by the fact that it can occur as an *á*-PP. But then we would expect it to have an alternative realization as a genitive, and as shown above, such a realization is highly marked at best.

The Phrasal Layering analysis would have to account for all of these case alternations, and in one direction. By contrast, the present analysis predicts the uniform nP syntax, where the case-marking properties of verbal heads will not be relevant.¹⁵

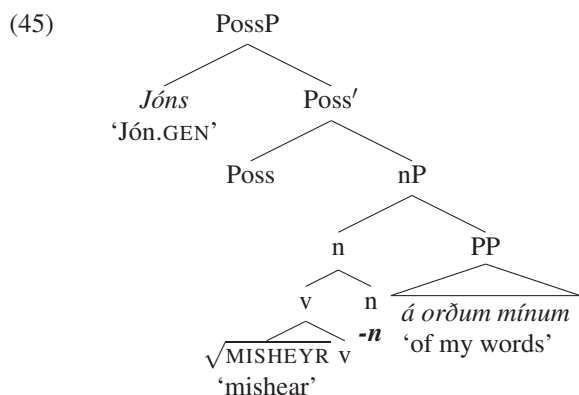

In chapter 5, I will discuss in more detail how the relation between n and its complement is interpreted, such that the experiencer reading is not available there, and the *á*-PP is the only option.

3.1.6 Should we even expect case patterns to be inherited?

Whether we expect case patterns to be inherited by a derived nominal of course depends on what our theory of case and nominalization is. However, I would like to emphasize that this question of architecture really should matter from almost any theoretical perspective.

First of all, we will see in some detail in chapter 4 that derived nominals can select the same PP that the verb selects. The explanation there is basically a semantic one, but nevertheless—given the close functional connection between case-marking and prepositions, and the way they are analyzed, it is not unreasonable to wonder why case is not inherited but P-selection can be. This fact suggests quite strongly that case, at least of the Icelandic sort, is something different from a hidden PP—the kind of selection that governs choice of PP is distinct from the kind of selection that governs the choice of case. It is not obvious that this fact falls out of all analyses of case and selection.¹⁶ Moreover, many researchers are happy to treat all non-accusative DPs as “hidden” PPs, which may be true sometimes, but in Icelandic is problematic for a number of reasons; this difference in inheritance can be added to that list of reasons.

Even more strikingly, if we set aside the PP selection issue, research on Icelandic case has always connected case-marking patterns closely to the argument structure, however that is represented in a given theory. At the same time, research on nominalization has long argued that derived nominals inherit the argument structure of the verbs they are derived from. It is thus of substantial architectural interest—for any model of grammar—that argument structure is inherited when case-marking cannot be.

¹⁵ I actually assume that the *mis*- prefix adjoins to the root, but it could also adjoin to v. I gloss over this here.

¹⁶ In fact, in languages where case appears to be inherited by a nominalization, one possible analysis is that what we call “case” in those languages really is a hidden PP. Below, however, I will discuss the case of Lithuanian, which seems to have a phrasal layering system, so the hidden PP analysis, while a possibility in principle, will not be considered in any detail at this time.

There is another, more empirical reason to expect that case patterns would be inherited by a nominalization under the phrasal layering analysis: case patterns in fact *can* be inherited by nominalizations in languages that show independent evidence in favor of a phrasal layering analysis. Here I focus on collaborative work with Milena Šereikaitė on Lithuanian (Šereikaitė & Wood 2020; Šereikaitė 2020; ?). In Lithuanian CENs, the accusative theme in the verb phrase corresponds to genitive in the nominalization (Šereikaitė 2020), much as in Icelandic, as shown in (46). Note that it is clear that the genitive in (46b) is not a PP, because PPs appear post-nominally, not pre-nominally, as we will see.¹⁷

- (46) a. Jon-as su-naik-in-o **augal-us.**
Jonas-NOM PRV-destroy-CAUS-PST.3 plants-ACC
'Jonas destroyed plants.' Active
- b. Jon-o **augal-u** su-naik-in-im-as
Jonas-GEN plants-GEN PFV-destroy-CAUS-NMLZ-NOM.SG
'Jonas's destruction of plants' CEN

However, unlike in Icelandic, case patterns can be inherited by nominalizations when internal arguments are assigned a case other than accusative. Šereikaitė (2020), drawing in part on Pakerys (2006) and Vladarskienė (2010), argues that non-accusative internal arguments in Lithuanian are of two types: inherent case and marked structural case. Marked structural case refers to case that is assigned in a way that shares properties with traditional structural case and traditional inherent case. Like inherent case, it is only assigned in the presence of particular verbs, and it can be retained in passives. Like structural case, however, it can alternate with other cases depending on the structural configuration. Here I will focus on this distinction as it manifests with dative case. Some verbs, such as *pritarti* 'approve', assign marked structural dative to their objects; in passives, these datives may remain dative or become nominative.

- (47) a. Parlament-as pritar-ė { **projekt-ui** / ***projekt-a** }.
Parliament-NOM approve-PST.3 {project-DAT / *project-ACC }
'The parliament approved the project.' Active
- b. **Projekt-ui** buv-o pritar-t-a parlament-o.
Project-DAT be-PRS.3 approve-PST.PASS.PTCP.[-AGR] parliament-GEN
'The project was approved by the parliament.' Passive
- c. **Projekt-as** buv-o pritar-t-as parlament-o.
Project-NOM be-PRS.3 approve-PST.PASS.PTCP-NOM parliament-GEN
'The project was approved by the parliament.' Passive

When verbs assigning marked structural dative are nominalized as CENs, this DP may become genitive, as we have seen for Icelandic, or—very much unlike Icelandic—it may remain dative, as shown in (48a–b).¹⁸

- (48) a. [Parlament-o greitas pritar-im-as **projekt-ui**] vis-us nustebin-o.
parliament-GEN quick approve-NMLZ-NOM.SG project-DAT everyone-ACC surprise-PST.3
'Parliament's quick approval of the project surprised everyone.'
- b. [Parlament-o greitas **projekt-o** pritar-im-as] vis-us nustebin-o.
parliament-GEN quick project-GEN approve-NMLZ-NOM.SG everyone-ACC surprise-PST.3
'Parliament's quick approval of the project surprised everyone.'

Other verbs, such as *tarnauti* 'serve', assign inherent dative case to their internal argument (E.F. Sigurðsson et al., 2018). When these verbs are nominalized as CENs, their arguments cannot correspond to genitive—but they can be retained, as dative.

- (49) a. Marij-a tarnav-o **atėjūn-ams.**
Marija-NOM serve-PST.3 invaders-DAT
'Marija served the invaders.'

¹⁷ Note that (46b) has an irrelevant reading 'destruction of Jonas's plants', presumably derived from a different structure. See ? for further examples, including examples drawn from the Lithuanian literature (e.g. Pakerys 2006).

¹⁸ The case patterns here correlate with word order: dative arguments appear to the right of the derived nominal while genitives appear to the left, a fact that Šereikaitė (2020) connects to the position of case assignment.

- b. Marij-os tarnav-im-as **atėjūn-ams**.
 Marija-GEN serve-NMLZ-NOM.SG invaders-DAT
 ‘Marija’s serving of invaders’
- c. * Marij-os **atėjūn-ų** tarnav-im-as
 Marija-GEN invaders-GEN serve-NMLZ-NOM.SG
 ‘Marija’s serving of invaders’

This is again unlike anything that we see in Icelandic nominalizations.

The Lithuanian pattern is exactly what we would expect Icelandic to look like if Icelandic CENs were derived from verb phrases, and indeed Šereikaitė (2020); ? argues that Lithuanian nominalizations are derived from full verb phrases. There is in fact quite a bit of independent evidence for a phrasal layering analysis in Lithuanian, and this evidence again shows how Lithuanian is different from Icelandic, exactly as we expect if Icelandic CENs are *not* derived from verb phrases.

I will first discuss evidence in favor of this conclusion from ditransitive verbs phrases. In Lithuanian, both internal arguments of a double object construction can be retained in a nominalization, and this holds regardless of the case frame of the verb. Case patterns are inherited as we now expect: structural accusative arguments are instead genitive (and appear to the left of the derived noun), while inherent cases are retained (and appear to the right of the derived noun). Consider the NOM-DAT-ACC verb *pristatyti* ‘deliver’.

- (50) a. Paštinink-as pristat-ė **mums siuntin-į**.
 postman-NOM deliver-PST.3 us.DAT package-ACC
 ‘The postman delivered us the package.’
- b. [Paštinink-o greitas **siuntini-o** pristat-ym-as **mums į**
 postman-GEN quick package-GEN deliver-NMLZ-NOM.SG us.DAT to
 namus] kainav-o ne-brangi-ai.
 home cost-PST.3 NEG-expensive-ADV
 ‘Postman’s quick delivery of the package to us to our house was not
 expensive.’

The dative is an inherent case, assigned by Appl, and it is retained in the nominalization along with the accusative argument, which becomes genitive in the nominalization (E.F. Sigurðsson et al. 2018; Šereikaitė 2020).

For the verb *mokyti* ‘teach’, the applied argument is accusative and the other argument is assigned inherent genitive.

- (51) a. Marij-a mok-ė **užsienieči-us lietuvių kalb-os**.
 Marija-NOM teach-PST.3 foreigners-ACC Lithuanian language-GEN
 ‘Marija taught the foreigners Lithuanian language.’
- b. **užsienieči-ų** mok-ym-as **lietuvių kalb-os**
 foreigners-GEN teach-NMLZ-NOM.SG Lithuanian language-GEN
 ‘teaching of Lithuanian language to foreigners’

Here again, both internal arguments are retained in the nominalization. The accusative applied argument becomes genitive and appears to the left of the derived nominal, while the inherent genitive remains to the right (and maintains its genitive case).

Verbs like *kaltinti* ‘to blame’ take two internal arguments: one accusative and the other instrumental.

- (52) **Draug-ai** apkaltin-o **Tom-ą nebūtais nusikaltim-ais**.
 friends-NOM blame-PST.3 Tom-ACC imaginary crimes-INS
 ‘Friends blamed him for unprecedented crimes.’
- (53) **Tom-o** kaltin-im-as **nebūtais nusikaltim-ais** visus labai nustebino.
 Tom-GEN blame-NMLZ-NOM.SG imaginary crimes-INS everyone-ACC very surprise-PST.3
 ‘Blaming Tom for unprecedented crimes surprised everyone.’

Just like with the other patterns, the accusative argument becomes genitive and appears to the left of the derived nominal, while the inherent instrumental appears to the right and retains its instrumental case.

The fact that both internal argument DPs can be retained in a nominalization, with the case patterns inherited in a predictable way, is exactly what we expect if nominalizations are derived from a full verb phrase.¹⁹ It appears, then, that this is the correct analysis of nominalizations of this sort in Lithuanian.

Once again, Icelandic is different in exactly the expected way. In Icelandic, only one internal argument DP is possible in nominalizations (Maling 2001): case patterns cannot be inherited, and only one internal argument can be retained. Consider *tileinka* ‘dedicate’ in (54a), which is a NOM-DAT-ACC ditransitive. When nominalized as *tileinkun*, it can inherit only one internal argument (see (54b)), and it must be the direct object (which in this case is the accusative) (see (54c–d)).

- (54) a. Hann *tileinkaði konunni sinni bókina*.
 he dedicated wife.DAT his.DAT book.the.ACC
 ‘He dedicated the book to his wife.’
- b. **tileink-un bókarinnar konunni sinni*
 dedicate-NMLZ book.the.GEN wife.the.DAT his.DAT
 INTENDED: ‘the dedication of the book to his wife’
- c. *tileink-un rithöfundarins*
 dedicate-NMLZ author.the.GEN
 ‘the author’s dedication’
- d. **tileink-un konunnar*
 dedicate-NMLZ wife.the.GEN
 INTENDED: ‘dedication to the wife’

This is surprising if Icelandic CENs are derived from full verb phrases. One might be tempted to assume that this derives from licensing constraints internal to nP. Suppose, for example, only one DP can be licensed inside nP as opposed to vP. This would rule out (54b), and would even explain (54d), because even in the verb phrase, *tileinka* ‘dedicate’ does not allow the dative goal unless the theme is also expressed.

The licensing explanation, however, ultimately fails, because the problem of inheriting vP structure is even more severe. Consider another NOM-DAT-ACC verb, *borga* ‘pay’ in (55). This verb allows either the dative or the accusative to appear as the sole argument, as shown in (55a,c), and in fact, the dative is probably far more frequent as a sole complement. Nevertheless, the dative goal cannot appear in the nominalization: only the accusative theme can (see 55b,d).

- (55) Þeir *borga börnunum peningana*.
 they pay children.the.DAT money.the.ACC
 ‘They pay the children the money.’
- a. Þeir *borga börnunum*.
 they pay children.the.DAT
 ‘They pay the children.’
- b. **borg-un barnanna*
 pay-NMLZ children.the.GEN
 INTENDED: ‘the payment of the children’
- c. Þeir *borga peningana*.
 they pay money.the.ACC
 ‘They pay the money.’
- d. *borg-un peninganna*
 pay-NMLZ money.the.GEN
 ‘the payment of the money’

This undermines any explanation in terms of nP-internal argument licensing: it is hard to imagine what goes wrong if the vP in (55a) is nominalized, if nominalizations are derived from vPs.

More broadly, Maling (2001), showed that goal arguments cannot correspond to genitives in nominalizations in the first place (or appear as dative or any other case). In the current framework, this can be reasonably interpreted as saying that ApplP is not possible in a nominalization. But if nominalizations are derived from verb phrases, a constraint like

¹⁹ Note that Bruening (2018b) argues that English nominalizations are derived from a full verb phrase, but does not offer an explicit account of why English nominalizations, like Icelandic nominalizations, cannot inherit both internal arguments of a double object construction (as in **his giving of Mary (of) a necklace*; see Kayne 1984; Pesetsky 1995). He suggests that this fact stems from “some (poorly understood) restrictions on what can appear with *of*” (Bruening, 2018b, 8). Even this explanation does not seem to extend to Icelandic, since PP themes and genitive in nominalizations show rather different behavior from English *of*.

that is mysterious—as underscored by the fact that ApplP is perfectly fine in Lithuanian nominalizations, which inherit case patterns and generally behave as we would expect from the phrasal layering analysis. Note also that Ingason (2016) has argued that Appl can appear internal to nPs, which would also undermine any attempted explanation along these lines.

The most likely explanation is that nouns—whether root-derived or word-derived—cannot take ApplP complements, which is probably a specific instance of a more general constraint that nouns cannot take small clause complements. (See below on ditransitives with one DP and one PP argument.)

Note that the constraint against multiple DP arguments holds regardless of what cases are assigned to the arguments. *Ræna* ‘rob’ can be a NOM-ACC-DAT ditransitive, but allows either the dative or the accusative to be the sole complement. However, the nominalization *rán* ‘robbery’ does not allow the accusative IO to be expressed as a genitive.

- (56) Bankinn rændi Sigurð eignum sínum.
bank.the robbed Sigurður.ACC possessions.DAT his.DAT
‘The bank robbed Sigurður of all his possessions.’
- a. Bankinn rændi Sigurð.
bank.the robbed Sigurður.ACC
‘The bank robbed Sigurður.’
- b. #rán Sigurðar
robbery Sigurður.GEN
= ‘Sigurður is the robber’
≠ ‘Sigurður is robbed’
- c. Bankinn rændi eignum þínum.
bank.the robbed possessions.DAT your.DAT
‘The bank robbed my possessions.’
- d. rán eignanna
robbery possessions.GEN
‘the robbery of the possessions’

Samlaga ‘assimilate’ can also have a NOM-ACC-DAT pattern, as shown in (57), but shows a different nominalization pattern, as shown in (57a–b).

- (57) Útlendingastofnun vill samlaga útlendinga samfélaginu.
immigration.office wants assimilate foreigners.ACC society.the.DAT
‘The immigration office wants to assimilate foreigners to society.’
- a. samlög-un útlendinganna
assimilate-NMLZ foreigners.the.GEN
‘assimilation of the foreigners’
- b. *samlögun samfélagsins
assimilation society.the.GEN
INTENDED = ‘assimilation to society’

In this case, it is the accusative that can correspond to the genitive, and the dative cannot.

The pattern in (56) is most likely an example of ApplP being impossible with derived nouns, where the accusative is an argument of an ablative-type Appl head (Pykkänen 2002, 2008; H.Á. Sigurðsson 2012a; Wood 2015). The pattern in (57) is likely to be something else. For example, the dative might be introduced in a structure with a PP headed by a phonologically null P (vP structure adapted from Bruening 2021).²⁰

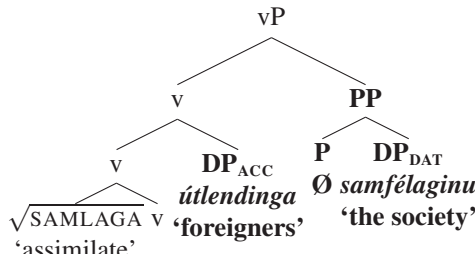
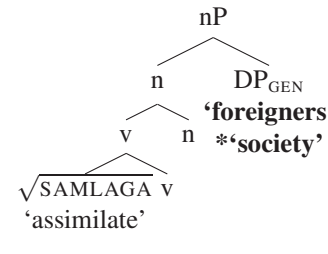
- (58) a. 
- b. 

²⁰ *Samlaga* ‘assimilate’ is actually morphologically complex, and not an atomic root, but I gloss over this here. The reader can most likely infer from chapter 4 what the analysis of the “complex root” would be.

In fact, the dative argument can be used in the nominalization, but the proposed P head must be overt.

- (59) samlög-un útlendinganna *(að) samfélaginu
 assimilate-NMLZ foreigners.the.GEN *(to) society.the
 ‘assimilation of the foreigners to society’

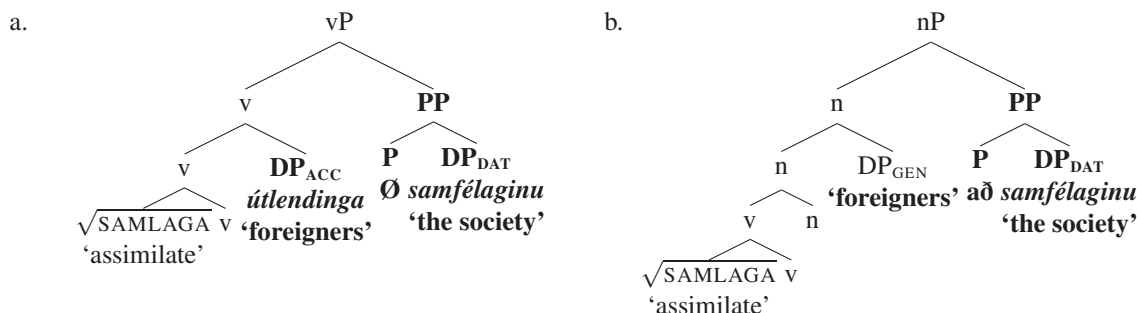

Thus, the complex head analysis can account for the range of facts discussed here by assuming that nouns cannot take small clause complements (including especially ApplPs), that PP arguments in ditransitives in fact do not involve a small clause, and that null prepositions that are licensed in verb phrases are not possible with nouns derived from the same verbs.²¹

It is important at this point to emphasize that this is only one approach to these facts that is available in the complex head analysis. It is the one that I suspect has the best chance of being on the right track, but there are other possibilities.²² What is really crucial is that differences of this sort are not particularly surprising with the complex head analysis the way that they are with the phrasal layering analysis. In the complex head analysis, nominalizations are constructed independently of verb phrases, subject to the constraints of noun phrase syntax and semantics. In the phrasal layering analysis, nominalizations are built on top of verb phrases. In a sense, any differences between nominalizations and verb phrases in the phrasal layering analysis must involve the nominal structure “undoing” things that a verb phrase can do, or at least failing to allow things that verb phrases might otherwise be allowed to do. This puts a stronger analytical burden on the phrasal layering approach, because it must be explained why the end result of undoing all those verb-phrase properties is something that looks syntactically like any other noun phrase. This burden is especially strong given the cross-linguistic facts from languages like Lithuanian that show that our expectations of what a phrasal layering analysis should look like are not misplaced: far from it, they are attested.

Finally, I would like to point out that many ditransitive verbs in Icelandic actually do not allow CEN formation. This is so for verbs like *leyna* ‘hide’, for which it is not even clear what the nominalized form would be, and verbs like *firra* ‘remove’, where the expected form is clear and in fact attested (*firing*). This is again very mysterious on the phrasal layering analysis. It is somewhat mysterious in the complex head analysis, too: we do not expect a root to idiosyncratically ban a zero interpretation of the n head past a semantically interpreted v head. I speculate that certain root+v combinations require a complement of a certain semantic type, a type that is built with an ApplP complement only. Since n cannot take an ApplP complement, a CEN nominalization, which inherits the interpretation of v, cannot take a complement with the denotation it needs. Whether this is the right explanation or not, it is hard to see what an analogous explanation would look like in the phrasal layering analysis.

²¹ Why might null prepositions be limited in this way? I suspect that it has to do with locality: just as a P-head cannot be subject to root-conditioned allophony past a v-head and an n-head (see chapter 4), the root-conditioned deletion/zero-realization of a P-head is impossible past a v-head and an n-head. Note that the zero realization of P-heads is indisputably root-conditioned, and not a general process in any way. The idea that null prepositions might be licensed in particular structural configurations is potentially supported by the distribution of DP-internal possessor datives discussed earlier in section 1.4.3. One possible analysis is that there is a silent P immediately preceding the DP-internal dative, but its silence is conditioned by the presence of the higher P. There are other possibilities (e.g. a DP-internal ApplP), but none that I can think of offer a natural explanation for the restriction to PP-internal contexts.

²² If Icelandic Appl attaches above the verb phrase, as Bruening (2010a,b, 2018a, 2021) has argued for English, then the facts connected with ApplP here follow automatically: there is never a verb phrase in the structure, so no opportunity for an Appl head. However, there are several problems with the assumption that Icelandic has a high Appl head (Wood, 2015), and even for English Bruening’s analysis is controversial (Ormazabal & Romero, 2012; Harley & Jung, 2015). Moreover, something else would still have to be said about the impossibility of null Ps.

3.2 Other problems for phrasal layering

3.2.1 The problem of *á*-PPs

The second main problem arises, for both Phrasal Layering and Parallel Structures, when we consider the *á*-PP expression of the theme. Since a PP expression of the theme is found in English, with *of* (and other languages in a similar way), it may not be obvious at first glance why this is a problem. In order to see why, consider first how English works. In a Parallel Structures analysis, the root must take the theme as a complement, and is dominated by an n head for nominalizations and a v head for verb phrases.

(60) John destroyed the city.

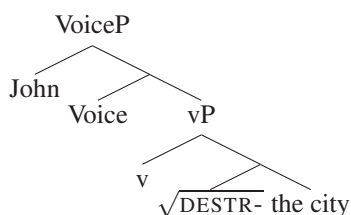

(61) John's destruction of the city.

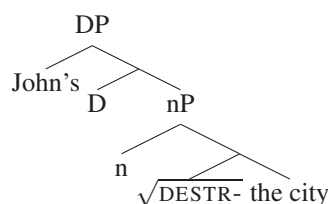

Since the root+complement structure is built independent of category, it must be the case that the higher structure determines whether *of* is present or not. For example, we might say that n cannot assign Case, and therefore *of* must be inserted into the structure post-syntactically (Harley & Noyer, 1997; Harley, 2009b) (see also Lyons 1986, 142; Rothstein 1992, 132); alternatively, the DP receives structural genitive case, which in English is realized as *of* (Alexiadou, 2017a).²³

The same set of possibilities arises on a layering analysis. There, the full verb phrase is constructed under the nominalizer, leading to the case problems mentioned earlier in the chapter. But even setting those aside, the structure still has to determine when the theme can be an *á*-PP and when it cannot, and that is determined by whether or not the vP is embedded inside a nominalizer. In either the Parallel Structures or the Phrasal Layering analysis, the theme is introduced within the verb phrase, wherever direct objects normally go. Then, some higher head at the NP level determines that the theme must be licensed for Case, and it gets assigned genitive, which is realized as *of*, or else it is saved by *of*-insertion.

Whether or not this analysis is viable for English, it is very hard to imagine that Icelandic could work this way. There is no reason to think that structural genitive assigned by n should be realized as a preposition *á*, and one that assigns dative at that. Icelandic has a morphological genitive, and surely that would be a more natural realization of abstract genitive Case. (And since genitive is in fact possible in such environments, it is not as though we can try to rule out that option somehow.) Moreover, treating *of* as a genitive marker makes some sense for English, which uses *of* to express many canonical possessive relations. This is not so for Icelandic *á*, which is not a possessive marker like English *of* is.²⁴

Beyond being an unlikely candidate for realizing an abstract Case relation, there is no reason to think that Icelandic needs anything like *á*-insertion. It has no shortage of actual case-markers to realize Case-relations. In fact, even if we assumed *á* is inserted post-syntactically, we would then still have to say how it assigned dative to its complement. (So extra case-marking is still needed.) In English, we see *of* showing up in a diverse set of environments, some of which seem like the kinds of environments where Case-licensing is needed, so *of*-insertion is triggered, including not just nouns but adjectives as well. But unlike *of*-marking, *á*-marking is not so general. Adjectives, for example, can take case-marked DP complements (H.Á. Sigurðsson, 2012a, 327–328).

²³ These options for *of* are forced in a Parallel Structures analysis if we assume that the root takes a complement. It would not arise if one assumed that the root was adjoined to n from the start. However, we have already seen that little v is present in nominalizations, so a parallel structures analysis, in order to avoid being a layering analysis, would have to assume that the root adjoined to v and then this complex v adjoined to n, which is basically the analysis pursued in this work. However, these facts have generally led to layering analyses, as in Harley (2009b).

²⁴ The only cases where *á* seems to have anything resembling a possessive use are in part-whole expressions like *þakið á húsinu* 'the roof on the house' and body-part possession like *hárið á henni* 'the hair on her'. However, this is more semantically contentful than English *of*, and not simple possession; the preposition *í* 'in' is also used in these functions when that makes sense, such as *hjartað í þér* 'the heart in you'. (Examples from Thráinsson 2007, 94–96.)

- (62) a. Hann var börnunum góður.
 he was children.the.DAT kind
 ‘He was kind to the children.’
 b. Hann var verður verðlaunanna.
 he was worthy prizes.the.GEN
 ‘He was worthy of the prizes.’

Moreover, non-deverbal nouns can take genitive complements, as seen with *hluti* ‘part’ in (63).

- (63) hluti lýsingarorðsliðarins
 part adjective.phrase.the.GEN
 ‘part of the adjective phrase’

This reinforces the conclusion that there is no structural need for anything like *á*-insertion in the context of a noun.

For another example, English uses *of* to mark partitive expressions like *most of the cars*. In Icelandic, there are at least three basic ways of constructing partitives (see Wood et al. 2015 and references therein), and none of them involve *á*:

- (64) a. Flestir **bílanna** hafa aldrei verið keyrðir.
 most.M.NOM the.cars.M.GEN have never been driven
 ‘Most of the cars have never been driven.’
 b. Flestir **bílnir** hafa aldrei verið keyrðir.
 most.M.NOM the.cars.M.NOM have never been driven
 ‘Most of the cars have never been driven.’
 c. Flestir **af bílunum** hafa aldrei verið keyrðir.
 most.M.NOM of the.cars.M.DAT have never been driven
 ‘Most of the cars have never been driven.’

In the first case, we see the partitive as a genitive DP. In the second, we see a full DP that agrees in case with the quantifier. In the third, we do see a preposition, but it is *af* ‘of/by/from’ not *á*. A similar situation is found with pseudopartitives, as pointed out to me by Halldór Sigurðsson (p.c.).

- (65) a. ? Þrjár flöskur víns voru á borðinu.
 three bottles.NOM wine.GEN were on table.the
 ‘Three bottles of wine were on the table.’
 b. * Þrjár flöskur vín voru á borðinu.
 three bottles.NOM wine.NOM were on table.the
 INTENDED: ‘Three bottles of wine were on the table.’
 c. Þrjár flöskur *(af) víni voru á borðinu.
 three bottles *(of) wine.DAT were on table.the
 ‘Three bottles of wine were on the table.’

(H.Á. Sigurðsson, 2003)

Here, the genitive is marked, and case-concord is impossible; the only fully natural option is to use a PP. But that PP is headed by *af* ‘of/by/from’ not *á*. Once again, this undermines any notion that Icelandic resorts to *á*-insertion for a general, dummy preposition.

Furthermore, both the *of*-insertion and the genitive-*of* analyses depend on the notion that the preposition serves a purely formal function, and cannot be sensitive to the interpretation of the nominal, the verb it contains, or the theme. However, *á* is arguably sensitive to the thematic interpretation of the object. Jóhannsdóttir (1995) notes that not all direct objects are possible, the way they are with English.

- (66) Kaiafas freistaði Júdasar.
 Kaiafas tempted Judas
 ‘Kaiafas tempted Judas.’

- a. ? Freist-ing Júdasar er nú alþekkt.
tempt-NMLZ Judas.GEN is now well.known
'The temptation of Judas is now well known.'
- b. * Freist-ing-in á Júdasi er nú alþekkt.
tempt-NMLZ-the on Judas is now well.known

(Jóhannsdóttir, 1995, 73)

- (67) Lögfræðingurinn varði sakamanninn.
lawyer.the defended criminal.the
'The lawyer defended the criminal.'
- a. Vör-n sakamannsins var umdeild.
defend-NMLZ criminal.the.GEN was debated
'The defense of the criminal was debated.'
- b. * Vör-n-in á sakamanninum var umdeild.
defend-NMLZ-the on criminal.the was debated

(Jóhannsdóttir, 1995, 73)

Jóhannsdóttir (1995, 73) suggests a reason that connects directly the the present proposal: "Icelandic has no semantically neutral preposition like English *of* which can be used in a wide connection. Most prepositions in Icelandic have a rather limited interpretation, so that it is not unlikely that in some cases no preposition comes close enough to describe the relations between the nouns."²⁵

We saw a similar situation earlier in the discussion of nominals like *misheyrn* 'mishearing' and *vöntun* 'need'. In both cases, the experiencer cannot be expressed by an *á*-PP, although it can be a genitive. In the case of *misheyrn* 'mishearing' (but not *vöntun* 'need'), the stimulus/theme was preferably an *á*-PP, and the genitive was marked. This sensitivity to the semantics is not expected with an *á*-insertion analysis, and Jóhannsdóttir's intuition is that *á* really is different from English *of* in the relevant respects. The overall picture presents a clear contrast between Icelandic *á*-PPs and English *of*-PPs, and suggests that unlike *of*, Icelandic *á* is doing some semantic work, or is only semantically \emptyset under certain conditions. Either way, it is not a likely case for a post-syntactic insertion rule.

Finally, many languages that use an *of*-like PP to express the object allow it to express a subject reading as well, in certain cases, as shown in (68a) for English. This is not so with Icelandic *á*, as shown in (68b):

- (68) a. the jump(ing) of the cows
b. # stökk-ið á { kúnum / kindunum }
jump-the on { cows.the / sheep.the }
≠ 'the cows' jumping'

Relatedly, in German, according to Alexiadou (2001, 81), *von*-PPs can express internal arguments, and *durch*-PPs can express external arguments.

- (69) a. der Angriff der serbischen Ziele durch die NATO
the attack the Serbian targets.GEN by the NATO
b. der Angriff der NATO von serbischen Zielen
the attack the NATO.GEN of Serbian targets

However, she notes that this *von* can be used to express an owner in result nominal:

- (70) die Beobachtungen von Vögeln
the observations of birds
'The birds' observations'

This too is different from Icelandic *á*, which cannot express the owner in a result nominal.²⁶

²⁵ There is, however, some speaker variation in some of these judgments. Sigríður Mjöll (p.c.) tells me that she finds (67b) a bit more colloquial than (67a), but not unacceptable as reported by Jóhannsdóttir (1995).

²⁶ Einar Freyr Sigurðsson tells me that for him, the indefinite *skoðanir á fuglum* 'observations of birds' may be more natural than (71a), but the basic point here remains unchanged.

- (71) a. #skoðanirnar á fuglum
 observations.the on birds.DAT
 ≠ ‘the birds’ observations’
 b. skoðanir fuglanna
 observations.the birds.GEN
 = ‘the birds’ observations’

This all suggests that *á* is not a last resort Case licenser, or a realization of genitive Case the way that *of* has been claimed to be. But if not, then it must somehow be present from the start, selected by the head that combines with it. In either the Phrasal Layering or Parallel Structures analysis, this creates a lookahead problem: a verb only selects *á*-PPs if it will eventually be embedded in nominalized structure. This is not how selection is generally thought to work. In Bruening’s (2013:31) phrasal layering analysis of nominalizations, he explicitly changes the verb’s selectional feature from [S:N] (to select an NP) to [S:P] to select a PP. But this information is gone as soon as the verb combines with the PP to form a verb phrase. The Voice head then combines with this VP is the same one (with the same features) that combines with VPs that are not destined to be nominalized. There is nothing in the system stopping the structure from continuing to project up to Aspect, Tense, etc., to form sentences like **They destroyed of the town*. Bruening (2013) does not seem particularly bothered by this, writing in a footnote that “It may be that the complement of the verb here is still of category N, with *of* functioning as a case marker. Because this is not important to the analysis, I simply change the selectional feature of the verb to [S:P].” The point here is that changing the selectional feature overgenerates, and the alternative that Bruening (2013) invokes is not a plausible analysis of Icelandic.

In the present analysis, on the other hand, it can be connected to the general rule allowing nouns to take PP complements. There is nothing unusual about it. The only thing that remains is to specify explicitly which preposition can serve to introduce the theme, and how this is accomplished semantically. In chapter 5, I will claim that like many functional heads, the preposition *á* can be semantically \emptyset in certain contexts, namely in the context of a noun with a certain interpretation. Since the \emptyset interpretation of *á* must be explicitly restricted particular syntactic and semantic contexts, restrictions on this use of *á* can be understood as part of the system of allosemy that determines when the \emptyset interpretation is available. Moreover, it can serve as the locus for particular, special interpretations in special contexts. See chapter 5 for more discussion of how the PP complement is interpreted.

3.2.2 Nominalizations of ditransitive verbs

Ditransitives have a handful of case patterns as well, and these patterns are not inherited by the derived noun either. What we find when we look at nominalizations of ditransitives is that indirect objects—more specifically arguments of Appl and/or silent prepositions—cannot be expressed in this way in nominalizations. This is unexpected on a phrasal layering account: if vPs are nominalized, then arguments and configurations that are licensed inside vPs should be inherited. One thing that Icelandic shows that may not be as obvious in English is that (a) this holds independent of case-marking patterns, and (b) indirect objects are impossible even when they can be the sole argument inside the verb phrase. The latter suggests that the constraint against indirect arguments is also independent of abstract Case licensing. That is, one might respond to the impossibility of inheriting two arguments of a ditransitive by proposing that vPs can introduce such arguments, but something about the nominalization environment prevents two arguments from being licensed. But this would predict, incorrectly, that when a verb is able to take a sole indirect object with no direct object, that indirect object can be inherited by the nominalization.

While I believe that this argument goes through for any number of approaches to ditransitives, I will explicitly assume, following the arguments in Wood (2015), that Icelandic indirect objects are introduced in a low ApplP. I consider indirect objects to be a particular sub-type of *indirect argument*, which refers to arguments in the verb phrase whose interpretation is mediated by some functional head other than the root or v head.

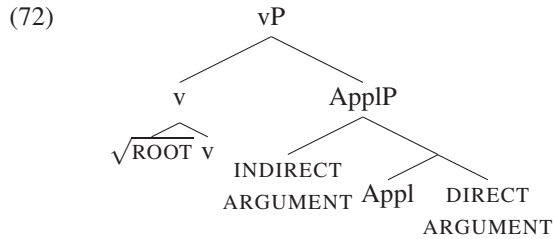

Also following Wood (2015), I assume that in some cases, a verb can appear to select two internal argument DPs if one of the DPs is actually introduced by a (possibly silent) preposition.

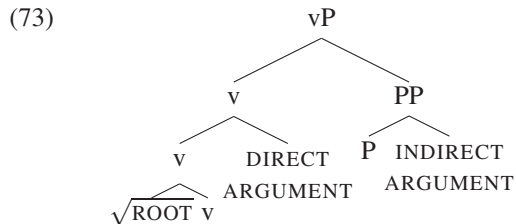

Consider, now, that in the analysis pursued in this book, nominalizations in Icelandic may inherit the semantics of verbs, but not the syntax of verb phrases. Thus, if Appl heads and silent Ps are the domain of verb phrases and not noun phrases, arguments introduced by Appl heads and silent Ps should not be possible in nominalizations. A straightforward case where this seems to hold is found with the NOM-DAT-ACC verb *afhenda* ‘deliver’. The nominalization of this verb, *afhending* ‘delivery’, can take an argument corresponding to the accusative direct argument, but not the dative indirect argument, which I assume is an applied argument (example adapted from Jóhannsdóttir 1995, 65).

- (74) Pósturinn afhenti frúnni þakkað.
 postman.the.NOM delivered lady.the.DAT package.the.ACC
 ‘The postman delivered the lady the package.’
- a. *Pósturinn afhenti frúnni.
 postman.the.NOM delivered lady.the.DAT
 INTENDED: ‘The postman delivered to the lady.’
 → *afhend-ing frúarinnar
 deliver-NMLZ lady.the.GEN
- b. Pósturinn afhenti þakkað.
 postman.the.NOM delivered package.the.ACC
 ‘The postman delivered the package.’
 → afhend-ing þakkans
 deliver-NMLZ package.the.GEN
 ‘the delivery of the package’

Since the dative DP *frúnni* ‘the lady’ is an indirect argument, introduced in SpecApplP, it cannot correspond to the genitive of the nominalization. In contrast, the accusative DP *þakkað* ‘the package’ is a direct argument of the verb, not introduced by any Appl head or silent P, and it can correspond to the genitive of the nominalization. However, as the presentation of examples above suggests, this example, and many like it, are potentially susceptible to another explanation. There, we see that the dative cannot appear alone, without the accusative, while the accusative can appear alone, without the dative. This is reminiscent of the ‘Sole Complement Generalization’ of Levin & Rappaport (1986), where it was proposed that the argument of an adjectival passive had to correspond to an argument that could be the ‘sole complement’ in the verb phrase, occurring without any other complement. In this case, we might say that the argument of a nominalization has to correspond to an argument that can stand alone as the sole complement in a verb phrase.

Initial indications in this direction—which I will argue to be misleading—come from the nominalization *kennsla*, derived from the verb *kenna* ‘teach’. The verb *kenna* ‘teach’ allows either the indirect object (IO) or the direct object (DO) to be the sole complement, and at first glance, it appears that either can be the argument of the nominalization *kennsla*.

- (75) María kenndi börnunum tungumálið.
 María.NOM taught children.the.DAT language.the.ACC
 ‘María taught the children the language.’
- a. María kenndi börnunum.
 María.NOM taught children.the.DAT
 ‘María taught the children.’
 → kenn-sla barnanna
 teach-NMLZ children.the.GEN
 ‘the teaching of the children’
- b. María kenndi tungumálið.
 María.NOM taught language.the.ACC
 ‘María taught the language.’
 → kenn-sla tungumálsins
 teach-NMLZ language.the.GEN
 ‘the teaching of the language’

This might seem to suggest a phrasal layering account of cases like (74) along the following lines. A vP can be nominalized only if it contains a maximum of one argument, perhaps because something about the nominalization environment provides syntactic licensing (such as abstract Case licensing) for only one argument. The dative argument of (74) cannot correspond to the genitive of the nominalization because it cannot be a sole argument of the vP—it only occurs when the accusative is also present. But if the accusative is present, then there are two DPs that need to be licensed, and nominalizations do not have the “licensing resources” for this. In contrast, the accusative argument can happily occur without the dative, so that kind of vP—where there is no dative—can be nominalized and the otherwise-accusative argument can be licensed as a genitive. In (75), either argument can occur as the sole complement in the vP, so either kind of vP can be nominalized and either argument, the otherwise-dative or the otherwise-accusative, can be licensed as a genitive.

While initially attractive, there are several reasons that this account does not go through. First, note that only one internal argument at a time can be inherited for a given nominalization, and this cannot be reduced to licensing. In (76), where there is a genitive and an *á*-PP, the genitive must correspond to the external argument. This cannot be attributed to Case licensing or the like, because both internal arguments should be licensed, one as a genitive and the other as a an *á*-PP.

- (76) kenn-sla barnanna á tungumálinu
 teach-NMLZ children.the.GEN on language.the
 = ‘the children’s teaching of the language’
 * ‘the teaching of the language to the children’

This is unexpected on a phrasal layering account, but follows from the present account as long as we assume, quite plausibly, that *n* cannot select or license the kind of structure that builds ditransitives in verb phrases. For example, we may assume that *v* may take a low ApplP complement, but *n* may not. The derived *n* is interpreted like the verb, but the complement of *n* must syntactically be a DP or PP, and therefore must correspond to a DP or PP with the appropriate interpretation in the verb phrase. Second, and more strikingly, while the genitive may seem to correspond to the applied dative argument, an *á*-PP may not.

- (77) a. kenn-sla-n á tungumálinu
 teach-NMLZ-the on language.the.GEN
 ‘the teaching of the language’
- b. * kenn-sla-n á börnunum
 teach-NMLZ-the on children.the
 INTENDED: ‘the teaching of the children’

If the genitive argument is truly inherited from the verbal meaning, there is no reason to expect that only one of the two possible “sole complements” could be expressed as an *á*-PP complement. Third, notice that even when the dative argument is a sole complement, it is still dative, just like when it is an indirect object. Of course, Icelandic

does allow dative direct objects, but it would be implausible to assume for one verb the same case would be assigned to an argument with the same semantic role in two different ways. That is, we would have to say that *kenna* ‘teach’ can be ditransitive, and the learner gets dative because it is an applied argument, or it can be monotransitive, and the sole complement gets “direct object dative” only if it is a learner—the same thematic interpretation that the applied argument gets—and accusative otherwise. Fourth, and perhaps most tellingly of all, a nominalization with the genitive only passes CEN tests when it corresponds to the accusative, not the dative.

- (78) a. *kenn-sla heils námskeiðs á aðeins þremur vikum*
 teach-NMLZ whole course.GEN in only three weeks
 ‘the teaching of a whole course in only three weeks’
 b. **kenn-sla tveggja barna á þrem vikum*
 teach-NMLZ two children.GEN in three weeks
 ‘the teaching of two children in three weeks’

All of this together suggests that the nominal head of *kennsla barnanna* ‘the teaching of the children’ is not really a CEN, but an SEN. The genitive is a possessor, and like possessors in general, can bear any number of relations to the head noun—in this case, a relation that resembles the one we find on applied objects in the verb phrase.

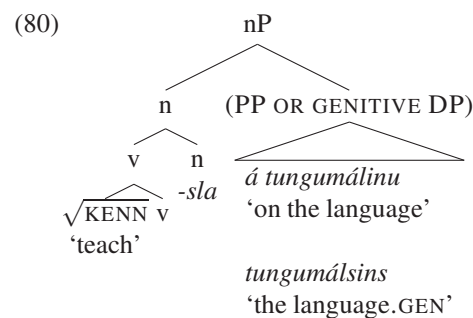
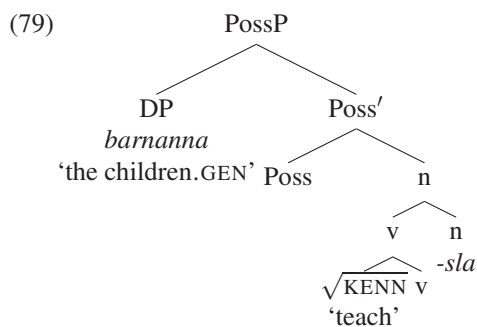

Nominalizations thus suggest that the dative argument of *kenna* ‘teach’, even when it is a sole argument, is an applied argument.²⁷ The same conclusion can be drawn, even more straightforwardly, for *borga* ‘pay’.

- (81) *Þeir borga börnunum peningana.*
 they pay children.the.DAT money.the.ACC
 ‘They pay the children the money.’
 a. *Þeir borga börnunum.*
 they pay children.the.DAT
 ‘They pay the children.’
 → **borg-un barnanna*
 pay-NMLZ children.the.GEN
 INTENDED: ‘the payment of the children’
 b. *Þeir borga peningana.*
 they pay money.the.ACC
 ‘They pay the money.’
 → *borg-un peninganna*
 pay-NMLZ money.the.GEN
 ‘the payment of the money’

In this case, we see that even though the dative can be the sole complement of *borga* ‘pay’, it cannot correspond to the genitive in the nominalization. This tells us two things. First, it is further evidence against an account of inheritance based on some version of the Sole Complement Generalization, in line with the conclusion drawn regarding *kenna*

²⁷ This could be because there is an implicit accusative argument, or because Appl takes the root or something else as its complement, as in some of the structures proposed by Ingason (2016).

‘teach’ above. Second, it suggests that there is in this case no “alternative route”—making ‘the children’ the possessor of an SEN reading of *borgun* ‘payment’ does not lead to a thematic interpretation that resembles the interpretation of the applied argument in the verb phrase. The generalization is that the direct argument can correspond to the genitive, and not the applied argument.

So far, we have seen that applied arguments cannot be inherited by the nominalization, whether they can be sole (overt) complements or not. But all of the applied arguments in question have been dative, which might lead one to wonder whether case plays a role. It turns out that it does not. Some applied arguments are not assigned dative case, but rather receive structural accusative case (nominative when passivized) (H.Á. Sigurðsson 2012a; Wood 2015; ?). The verb *ræna* ‘rob’ is one such verb, usually referred to as a NOM-ACC-DAT ditransitive, with an accusative indirect object and a dative direct object.²⁸ Like *borga* ‘pay’, either argument can stand alone as the sole complement. Also like *borga* ‘pay’, the “first object”, which according to the analysis endorsed here is an argument of Appl, cannot correspond to the genitive of the nominalization *rán* ‘robbery’.

(82) Bankinn rændi Sigurð eignum sínum.
bank.the robbed Sigurður.ACC possessions.DAT his.DAT
‘The bank robbed Sigurður of his possessions.’

a. Bankinn rændi Sigurð.
bank.the robbed Sigurður.ACC
‘The bank robbed Sigurður.’

→ *rán Sigurðar
robbery Sigurður.GEN
= ‘Sigurður is the robber’
≠ ‘Sigurður’s things are robbed from him’

b. Bankinn rændi eignum þínum.
bank.the robbed possessions.DAT your.DAT
‘The bank robbed your possessions.’

→ rán eignanna
robbery possessions.GEN
‘the robbery of the possessions’

Thus, *ræna* ‘rob’ behaves like *borga* ‘pay’ except that its applied argument is not dative. This shows that the generalization about inheritance has to do with being an argument of the verb (a direct argument) rather than an argument of another verbal head such as an Appl head, irrespective of the case that that argument may receive.

Not every descriptively NOM-ACC-DAT ditransitive behaves like *ræna* ‘rob’, however. Verbs like *samlaga* ‘adapt’ also take a first object that is accusative and a second object that is dative. When *samlaga* ‘adapt’ is nominalized, however, the pattern is opposite of *ræna* ‘rob’: only the accusative, and not the dative, may correspond to the genitive.

(83) Útlendingastofnun vill samlaga útlendinga samfélaginu.
immigration.office wants assimilate foreigners.ACC society.the.DAT
‘The immigration office wants to assimilate foreigners to society.’

a. samlög-un útlendinganna
assimilate-NMLZ foreigners.the.GEN
‘assimilation of the foreigners’

b. *samlögun samfélagsins
assimilation society.the.GEN
INTENDED = ‘assimilation to society’

This pattern suggests that in this case, the accusative “first object” is in fact the direct argument of the verb, and the dative is a secondary or indirect argument of some kind. Logically, there are several possibilities for what the structure could look like. It could be that the dative is a rightward projecting specifier of an Appl head, if one’s theory allows rightward specifiers (Folli & Harley 2013; Bruening 2010b, 2018a).

However, I believe that a more likely structure is that in this case, the dative argument is in fact introduced by a silent preposition, such as in the structure in (84) (which has a vP structure adapted from Bruening 2021).²⁹

²⁸ The meaning/use of the terms ‘direct’ vs. ‘indirect’ object varies across theories, but what is consistent is the assumption that the accusative argument of *ræna* ‘rob’ occupies the same structural position as the dative of verbs like *afhenda* ‘deliver’.

²⁹ *Samlaga* is actually morphologically complex, and not an atomic root, but I gloss over this here.

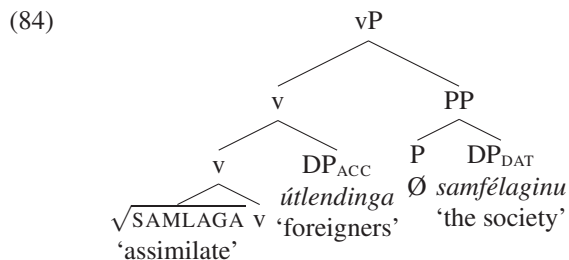

Evidence in favor of this view comes from the fact that when *samlaga* ‘adapt’ is nominalized, the argument corresponding to the dative can be expressed as long as the P head is overt. This suggests a structure like (85b), parallel to (84), except that P must be overt.

- (85) a. *samlög-un útlendinganna *(að) samfélaginu*
 assimilate-NMLZ foreigners.the.GEN *(to) society.the.DAT
 ‘assimilation of the foreigners to society’

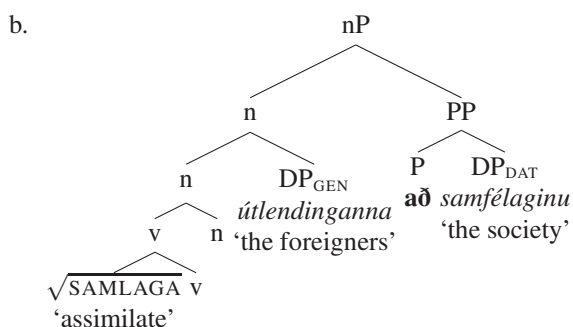

In fact, as far as I know, this is a specific instantiation of a language-wide fact: if silent prepositions exist in Icelandic, they are never allowed to introduce the complements of nominalizations (Wood, 2015, ch.6). The fact that silent prepositions are not freely available suggests that they must be licensed, which I return to immediately below.

One reasonable objection to the silent P analysis is that we know that datives like *samfélaginu* ‘the society’ can in principle undergo Object Shift, and we know equally that PPs in Icelandic cannot undergo Object Shift, and that Object Shift cannot strand overt prepositions (Collins & Thráinsson 1996; Svenonius 2002; Wood 2015). Finally, there are many clear cases of direct object datives that cannot be analyzed as involving a silent P (Wood, 2015). These facts combined might make a reasonable linguist skeptical that there is a PP in structures of this kind. However, such observations are not necessarily fatal: the account simply requires that either PPs headed by null Ps can undergo object shift, or that DPs can move out of a PP headed by a null P, even though it cannot move out of a PP headed by an overt P. I will suggest that the latter approach is more likely on the right track.

There is a theoretical reason to connect the silence of a P head and the availability of DP movement. It has been argued independently that silent Ps have to be licensed, and that head movement to the verb is one such way to license them (Den Dikken 1995, 2010; Myler 2013). It has also been proposed that head movement can extend locality domains for A-movement (Chomsky, 1995; Collins & Thráinsson, 1996; Den Dikken, 2006, 2007a,b; Kupula, 2011; Wood & H.Á. Sigurðsson, 2014). Putting these things together, we can embrace the possibility that there is a null P, but it must be licensed by head-movement—which simultaneously licenses its silence and extends the movement locality domain of its DP complement, allowing the latter to undergo Object Shift.³⁰

³⁰ There are several technical avenues one might take to work out such an analysis, which I will not develop because it goes beyond the scope of the present work, and the point here is simply to argue that an analysis along these lines is possible. However, I would like to point out that many accounts of Object Shift already have to say something very close to what I am saying here, to account for Holmberg’s Generalization (Collins & Thráinsson, 1996; Holmberg, 1999; Fox & Pesetsky, 2005). When Object Shift applies, the object moves to the left of the verb, and this is only licit if the verb then head moves to the left of the object, restoring verb-object word order. The present account involves the same thing: the object can move to the left of the preposition, but the preposition must head move to the verb, restoring preposition-object word order. The process then repeats, with the object moving to the left of the verb, and the verb head moving to the left of the object. This kind of leapfrogging is already a standard feature of the analysis of Object Shift, so it seems reasonable to extend it to Object Shift out of a PP, accounting for the requirement that the P head is silent (it must undergo head-movement) and the absence of Object Shift out of a PP with an overt head (since the P head in such cases has not undergone the necessary head movement).

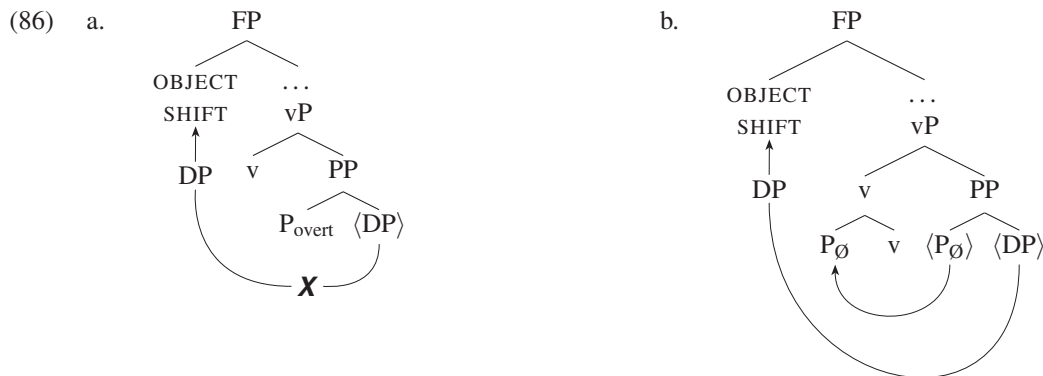

Returning to the contrast with nominalizations, the complex head analysis provides an explanation for why null Ps are sometimes possible with verbs but never possible with the nouns derived from them. When the PP is in the same domain as the verb—namely its complement—a silent P can undergo head movement to the verb for licensing. However, if the PP is the complement of a noun built on a verb, the P head cannot, according to standard views on the locality of head movement, move to the “inside” of the noun and attach to the v head contained inside it.



Deverbal nominalizations can take PP complements, as long as the P head is overt.

I would like to note in passing that the syntactic mechanism of licensing a null preposition by head movement requires independent theorizing, which I will not undertake in this work; see the above cited references for some proposals. One possibility that I would like to raise that does connect more closely with the issues that are central to this book, however, is that licensing of zero Ps by head movement could be recast as allomorphy conditioned by local roots. By moving P to the v head, it becomes close enough to the root to have its morphological realization—as zero—conditioned by it. In Wood (2015), I consider this possibility briefly for independent reasons, pointing out that Biskup & Putnam (2012) have argued for this possibility; they propose that in German, the preposition *aus* ‘out’ can head move and prefix to the verb, and in this position it is spelled out as *ent-*. Rather than giving zero Ps a special syntactic status that requires specific syntactic configurations, the zero realization of P could well be a matter of allomorphy: head movement doesn’t license silence per se, it simply puts the preposition in a local configuration with a root that conditions a zero allomorph. Whatever the account is, the idea that null heads undergo head movement and the idea that head movement extends locality domains have both been proposed independently of the present proposal, and seem to me to offer a promising account of why the distribution of null prepositions in Icelandic seems to be restricted in the way that it is.³¹ Notice that an explanation along these lines is not available for a Phrasal Layering analysis, since there is a full vP, with the PP as a complement to v, so there is no reason a silent P could not be licensed—at the very least, some other explanation would be needed.

A final note I would like to make is that many intransitive verbs do not seem to nominalize at all—or at least do not form CENs or other meaning-preserving nominalizations. For example, the verb *leyna* ‘hide’ cannot form a CEN of any kind; there is a(n arguably root-derived) nominal *leynd* ‘stealth’, but this is not a CEN. I tentatively suggest that such cases have a verbal semantics that requires a kind of complement that n cannot take. For example, we saw above

³¹ Another possibility is that movement need not be involved, but the silent P must be in a relation that is local to a root. Notice that we can define essentially the same locality condition that we already saw for conditioning idiosyncratic meaning between the root and P: no more than one category head can intervene between the root and the silent P. This rules out silent P in nominalizations. However, the nature of that relation would need to be worked out, and I don’t know of any ready explanation for it that connects to independently proposed principles, which is why I find the head movement account at least initially more promising in this respect.

that *n* cannot take an ApplP complement; when verbs that may take an ApplP or a DP complement are nominalized, only the DP complement is possible. If a verb could only take an ApplP complement due to its semantics, then a noun derived from that verb would not be possible: its semantics would require a complement type that the syntax could not provide. Whether this is the right account of all or even some such cases, I must leave to future research. However, I would like to note once again that facts like these are harder to account for in a Phrasal Layering analysis; one cannot easily restrict the kinds of complements a verb can take just in case that verb forms a verb phrase that is later embedded under a nominalizing head.³²

3.2.3 Nominalizations of *-st* verbs

Another issue with the phrasal layering analysis has to do with the nominalization of *-st* verbs. In Icelandic, *-st* is a morpheme that seems to mark the absence of an expected argument slot. Wood (2015) has argued that this is because it is an argument expletive, which is syntactically a clitic, that fills an argument slot syntactically but gets no semantic interpretation. It moves into one of two clitic licensing positions in the inflectional field. Wood (2015) noted that *-st* does not appear in derived nominals, but did not emphasize the fact that nominals derived from *-st* verbs are quite possible. This is particularly striking for verbs that might be thought of as “deponent” *-st* verbs: verbs that only occur with *-st* when they remain verbs. Consider the following examples.

- (88) a. Guðrún dá-ði-st að Maríu.
Guðrún admired-PST-ST at María
'Guðrún admired María.'
(adapted from H.Á. Sigurðsson, 1989, 262)
- b. að-dá-un Guðrúnar á Maríu
at-admire-NMLZ Guðrún.GEN on María.DAT
'Guðrún's admiration of María.'
- (89) a. Drengurinn undra-ði-st mannfjöldann.
boy.the.NOM marveled-PST-ST crowd.the.ACC
'The boy marveled at the crowd.'
- b. undr-un drengsins
marvel-NMLZ boy.the.GEN
'the boy's marvelment'
(Jóhannsdóttir, 1995, 68)
- c. undr-un drengsins á mannfjöldanum
marvel-NMLZ boy.the.GEN on crowd.the
'the boy's marvelment at the crowd'
- d. # undr-un mannfjöldans
marvel-NMLZ crowd.the.GEN
'the crowd's marvelment'
* 'the marvelment (of someone) at the crowd'
- (90) a. Þér hafa víst misheyrst orð mín!
you.DAT have surely misheard words my
'You have surely misheard my words!'
- b. Misheyr-n Jóns á orðum mínum olli vandræðum.
mishear-NMLZ Jón.GEN on words my caused problems
'Jón's mishearing of my words caused problems.'

The verb *dá* does exist without *-st*, but it means ‘adore’ (not ‘admire’) and it does not take an *að*-PP argument. The nominalization in (88b) is clearly nominalizing the use in which *-st* is obligatory for the verb, since the *að* is prefixed

³² One would presumably adopt a licensing analysis of some kind, where a verb cannot introduce two objects because it can only (Case) license one of them. Such an approach would have to explain what rules out licensing one object with a genitive and the other with an *á*-PP. Note also that the proposal here is about the semantics of the verb that is inherited by the noun, so it is not necessarily limited to cases where to overt syntactic DPs are introduced, like a licensing account would be.

to the nominal; see chapter 4 for a detailed discussion of such prepositional prefixing. The verb *undrast* ‘marvel’ does not exist without *-st*, and yet it can be nominalized as in (89b). The verb *misheyrast* ‘mishear’ does not occur without *-st*, and yet it can be nominalized as shown in (90b).

The issue is that to analyze these *-st* verbs, something has to be said about the building of verb phrases that requires the *-st* clitic to be part of the verb phrase. If nominalizations are built on top of verb phrases, *-st* should be an obligatory part of those nominalizations. The same reasoning applies to the anticausative reading of *opnun* ‘opening’, since with the verb, the anticausative takes the *-st* morpheme. Consider (91)–(92) (repeated from (93)–(94) in chapter 2).

- | | | | | |
|------|----|---|------|---|
| (91) | a. | Guðrún opnaði hurðina. Guðrún.NOM opened door.the.ACC ‘Guðrún opened the door.’ | (92) | skyndileg opn-un hurðarinnar sudden open-NMLZ door.the.GEN ‘the sudden opening of the door’ |
| | b. | Hurðin opnaði*(-st). door.the.ACC opened*(-ST) ‘The door opened.’ | | a. ✓ Passive reading (implicit agent) b. ✓ Unaccusative reading (door opens on its own) |

In order to get the unaccusative reading, the verb phrase requires *-st*, which would lead us to expect the *-st* morpheme in the unaccusative reading in the nominalization.

One way out of this conundrum would be to suppose that nominalizations are built on vPs and not VoicePs, which as we have already seen, is independently plausible. According to the analysis in Wood (2015), at least *opnast* ‘(unaccusative) open’, *misheyrast* ‘mishear’, and possibly also *undrast* ‘marvel’ (see Wood 2015, 242), are built with *-st* in SpecVoiceP. The logic of that system is explicitly such that if Voice is present, *-st* must be in its specifier, but nothing necessarily goes wrong if Voice is not present at all (see Wood 2015, section 3.5.3, 152–155).

However, Wood (2015) argues that *-st* is merged lower, within the vP, in cases like (88a), as well as in cases like (93a) below. And yet, they too can form derived nominals, with no *-st* clitic.

- | | | |
|------|----|--|
| (93) | a. | að troða-st gegnum skóginn to squeeze-ST through woods.the ‘to squeeze through the woods’ |
| | b. | Víða var enginn troð-ningur gegnum skóginn widely was no squeeze-NMLZ.NOM through forest ‘Throughout there was no squeezing through the forest.’ ³³ |
| | c. | troð-ningur gegnum skóginn squeeze-NMLZ through woods.the ‘squeezing through the woods’ |
| | d. | troð-ningur þeirra gegnum skóginn squeeze-NMLZ their.GEN through woods.the ‘their squeezing through the woods’ |

Similarly, the verb *annast* ‘take care of’ does not exist without *-st*, and yet it can be nominalized as shown in (94b).³⁴

- | | | |
|------|----|--|
| (94) | a. | Hún annaði-st (um) barnið. she take.care-PST (of) child.the ‘She took care of the child.’ |
| | b. | um-önn-un-in á barninu of-take.care-NMLZ-the on child.the.DAT ‘the taking care of the child’ |
| | c. | um-önn-un barnsins of-take.care-NMLZ child.the.GEN ‘the taking care of the child’ |

³³ <https://timarit.is/page/960927>, Ret. Jan. 9, 2019

³⁴ Note that most speakers prefer to leave the preposition *um* out with *annast* as in (94), and some find *um* better with a verb phrase like *annast um málið* ‘take care of the issue’. This is not relevant here, but see further discussion in chapter 4.

For this verb, *-st* is not merged in SpecVoiceP, as shown by the fact that it can be passivized:

- (95) Það var anna-st um barnið.
 EXPL was taken.care-ST of child.the
 ‘The child was taken care of.’ (Thráinsson, 2007, 255)

Since *-st* is not merged in SpecVoiceP, it is merged lower in the verb phrase. This suggests that it is not enough to say that the absence of *-st* in the nominalized form is due to *n* attaching before *-st* would have merged.

Another response might therefore be to say that *-st* cannot be merged because it cannot be licensed without the necessary functional structure. But this is rather problematic, as it implies either a fair amount of lookahead (the verb phrase has to “know” that it will be nominalized, and avoid *-st* as a result), or a rather complex transderivational comparison. That is, one would have to somehow say that *-st* is required to merge for the appropriate verb meaning to arise only when it will be licensed; otherwise, the verb phrase can be happily built without *-st* and achieve the relevant meaning. It is not clear to me how to execute this kind of analysis, especially since in the analysis of Wood (2015), *-st* does not *directly* condition verb meaning, and even if it did, it would be a challenge to work out how the relevant meanings are computed with reference to the possibility of *-st*, whether it is merged or not.

Suffice it to say that the nominalization of *-st* verbs at least raises some nontrivial challenges for the phrasal layering analysis. These challenges do not arise on the present approach. In the present analysis, the complex head is built directly, and there is never a slot to insert *-st* to begin with. Under the view that *-st* does not influence the meaning of the verb directly, but only indirectly via the properties of functional heads in the verb phrase, *-st* is not necessary to derive the appropriate meaning of a deverbal nominal either. The present approach straightforwardly predicts that it is possible to build nominalizations of *-st* verbs, as well as the fact that *-st* will not appear in such nominalizations.

3.2.4 Synthetic compounds

In this section, I briefly discuss synthetic compounds, and show that they face similar challenges to the nominalizations seen so far, especially with respect to case inheritance. In particular, nonheads seem capable of bearing case, but when they do, it is genitive, rather than the case the the verb would have assigned, such as dative. I agree with Alexiadou (2017b) and Iordăchioaia (2019a) that synthetic compounds have most of the properties of complex event nominals, with differences to be explained in Chapter 5. I argue that this is problematic for the same reason; given how synthetic compounds have been proposed to work, we would expect the nonhead to be able to be dative, contrary to fact.

I propose that compounds, whether synthetic or not, are built with adjunction of the nonhead to the head (as proposed by Harðarson (2016, 2017, 2018) for primary compounds).³⁵ The structure for *evidence examination* would then be as in (96).

- (96)
-
- ```

graph TD
 n1[n] --- n2[n]
 n1 --- n3[n]
 n2 --- EVID[√EVID]
 n2 --- n4[n]
 n3 --- v[v]
 n3 --- n5[n]
 v --- EXAM[√EXAM]
 v --- v2[v]

```
- ence                      ation  
in

The only difference between a synthetic compound and a primary compound, according to this view, is that the head of a synthetic compound has the meaning of the verb it is derived from. In chapter 5, I will discuss differences between synthetic compounds and primary compounds, on the one hand, and between synthetic compounds and non-compound argument-structure nominals, on the other. In this section, I turn to the phrasal layering analysis of synthetic compounds, and argue that Icelandic synthetic compounds raise problems for that analysis.

<sup>35</sup> This is in contrast to analyses of compounds based on phrases plus movement, as in Harley (2009a) (see also Steddy 2019) for primary compounds, and many others for synthetic compounds (Alexiadou, 2017b; Iordăchioaia et al., 2017; Iordăchioaia, 2019a; Michelioudakis & Angelopoulos, 2019; Ntelitheos, to appear). See also Whelpton & Harley (2016) for an interesting study of pseudopartitive compounds such as *kaffibolli* ‘coffee cup’, which, unlike in English, can refer to the coffee rather than the cup.

The phrasal layering analysis of synthetic compounds from Alexiadou (2017b), Iordăchioaia et al. (2017) and Iordăchioaia (2019a) is shown in (97), for the Icelandic compound *bóklestur* ‘book-reading’.

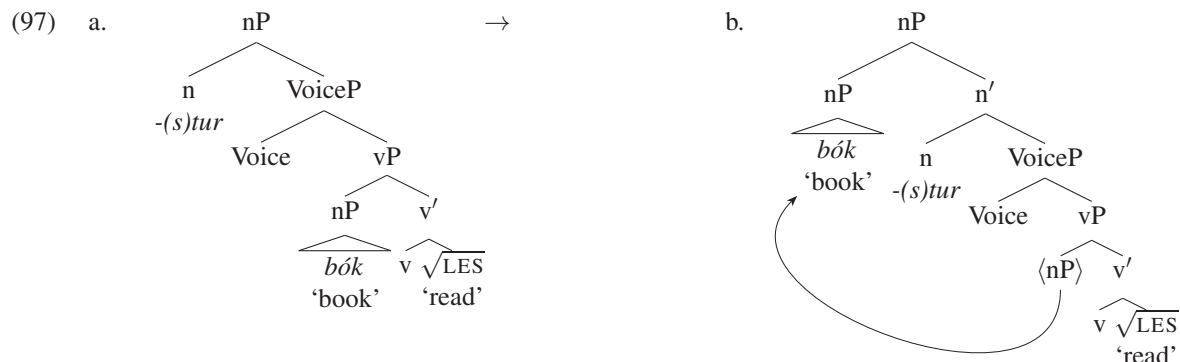

According to this analysis, the nonhead is an nP that originates in the direct object position of the verb (here, SpecvP, but it could just as well be the complement of v or the root). Because it is an nP and not a DP, it cannot be Case-licensed in situ, but must move to SpecnP for licensing.

*If the non-head were a DP, it would either receive accusative case from the verb, or genitive case from the nominalization (like in ASNs such as in (4b)). But as a nP, the non-head cannot be marked for case and is illicit in this argumental position (cf. Longobardi 1994), so it has to move.* (Iordăchioaia et al., 2017, 65)

This analysis solves the classic bracketing paradox of synthetic compounding in languages like English. The nonhead is an argument of the verb because it merges where verbal arguments merge, combining first with the verb. However, we do not force the existence of a verbal compound *to book-read*, because it is merged as a phrasal argument, and at any rate the nonhead cannot stay in that position; it must move to SpecnP, which would not be available outside of the nominalizing environment.

The problem that Icelandic raises is by now familiar: by including a full verb phrase structure, we expect the nonhead to be able to be dative, when the verb assigns dative. For example, recall that *aka* ‘drive’ takes a dative object, as illustrated in (98a). The nonhead of a synthetic compound, however, takes genitive and not dative, as illustrated in (98b-c).

- (98) a. Jón ók leigubílum.  
 Jón.NOM drove taxi.the.DAT  
 ‘Jón drove the taxi.’
- b. leigubíla-ak-stur Jóns  
 taxi.GEN-drive-NMLZ Jón.GEN  
 ‘Jón’s taxi-driving’
- c. \*leigubílum-ak-stur Jóns  
 taxi.DAT-drive-NMLZ Jón.GEN

Now we are led to ask whether we really would have expected dative case at all. One possibility is that the nP is too small to receive any case, and this is the reason that we do not see dative. This might be connected to the fact that the nP has to move to SpecnP for (Case) licensing.

However, there are reasons to think that the nonhead is not too small to receive case. As for the licensing movement, this cannot be connected to morphological case marking, since it is well known that Case licensing (governing the distribution of arguments) is distinct from morphological case marking; Icelandic is in fact one of the clearest cases where this holds. A dative theme, for example, must still move for licensing in the same way that a nominative theme must (under passivization, for example). So we can disregard the idea that movement to SpecnP would be expected to affect the morphological marking of the moving nP.

As for the idea that the nP is too small to receive morphological case, this is undermined by the fact that the nonhead very often shows up in the genitive. It is important to emphasize here that it is generally argued that genitive nonheads really are genitive; the genitive morpheme is not simply a linking element that happens to look genitive, as can be observed in other languages (Indriðason, 1999; Harðarson, 2016, 2017). Icelandic also has linking elements in

some compounds—these are distinct from genitive marking on nonheads. Harðarson (2016, 2017) argues that genitive nonheads are structurally larger than bare nonheads, but nonheads with linking morphemes are essentially the same as bare nonheads.

Harðarson (2016, 2017) observes that in a three-word compound, when both lefthand words are genitive, or when both are bare, the constituency is ambiguous.

- (99) a. eink-a #bíl-a #stæði  
private-GEN #car-GEN #space  
'parking spot that is private'  
'(parking) spot for private cars'
- b. járn #stól #fótur  
iron.STEM #chair.STEM #leg  
'iron leg of a chair'  
'leg of an iron chair'

However, when only one of the first lefthand words is inflected, the structure is unambiguous: if the 1st word is uninflected, only left branching is allowed; if the 2nd word is uninflected, only right branching is allowed.

- (100) a. karl-a #hest #vagn  
man-GEN #horse.STEM #wagon  
'a horse carriage for men'  
≠ 'a carriage drawn by male horses'
- b. karl #hest-a #vagn  
man.STEM #horse-GEN #wagon  
≠ 'a horse carriage for men'  
'a carriage drawn by male horses'

He establishes this generalization by generating nonce examples, and by studying a corpus of attested examples.<sup>36</sup>

Harðarson derives this generalization in the following way. First, he proposes that the inflected elements are not just morphological decorations, but reflect a more complex structure. An inflected noun, such as *bíla* 'cars.GEN' in *einkabílastæði* 'private car spot (parking spot)', would have the structure in (101a). An uninflected noun, such as *bíl* 'car' in *einkabílstjóri* 'private car-driver (i.e. 'chauffeur')', would have the structure in (101b).

- (101) a.
- b.

Second, he proposes that compound formation is subject to the Matching Condition:

- (102) *The Matching Condition*  
Compounding merges elements of the same syntactic type

Given the structure above, the Matching Condition would allow compounds of three types:<sup>37</sup>

- (103) a.
- b.
- c.

We can now see how the Matching Condition derives the branching generalization above. Consider *karl-a-hest-vagn* 'man-GEN-horse-wagon', which has genitive on the first word and only allows the right branching structure.

<sup>36</sup> There are some counterexamples, which Harðarson analyzes in various ways. Note that most of the counterexamples are established words. The generalization seems to hold firmly in novel, online compound formations. There are various ways one could analyze established words (e.g. an inflectional genitive developing into something like a linking element) that would not be plausible for novel formations.

<sup>37</sup> Note that what is important here is the topmost category of each constituent; they could differ in their internal structure.

- (104) a. *karl-a #hest #vagn*  
 man-GEN #horse #wagon  
 ‘a horse carriage for me’  
 ≠ ‘a carriage drawn by male horses’



Since the leftmost word must be at least a  $\phi$ , it must combine with a  $\phi$ . Therefore, the only structure consistent with the Matching Condition is the structure in (105).

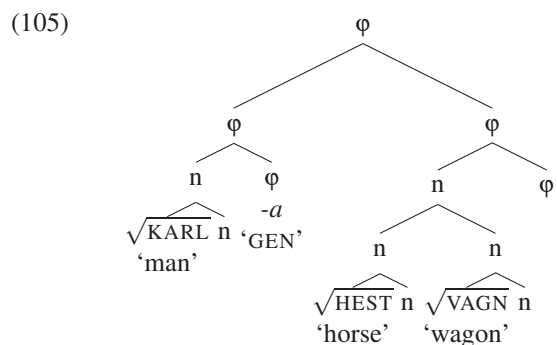

Any kind of left branching structure would necessarily involve a violation of the Matching Condition.

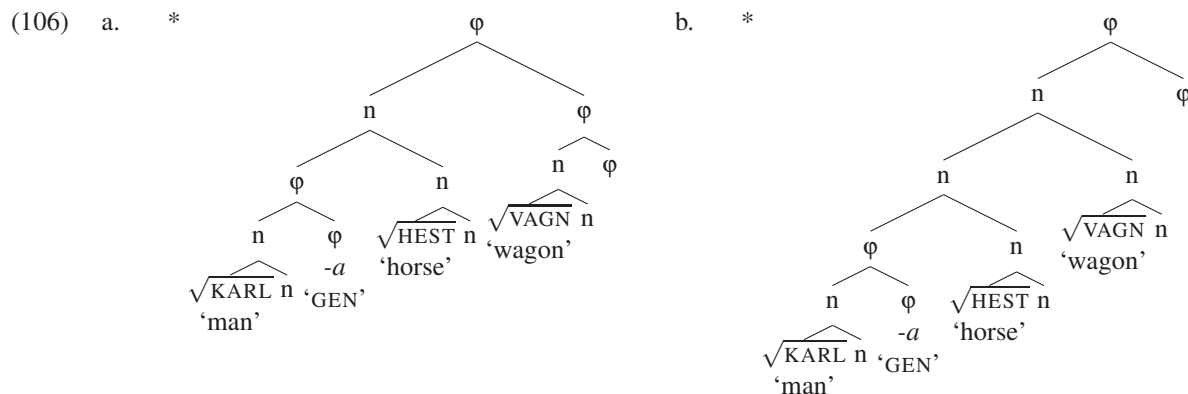

The reverse goes for *karl-hest-a-vagn* ‘man-horse-GEN-wagon’: it can only be left branching. However, when both lefthand words are bare, or both are genitive, they are free to be ambiguous because they are all of the same size, so the Matching Condition will allow them to combine in any order.

Returning to the main point, we are interested in the question of whether the matching condition holds in synthetic compounds, and more specifically whether we would expect dative case to be possible on the nonhead of a compound. First, the Matching Condition does seem to hold in synthetic compounds. Consider, for example, the compound *bók-lestur* ‘book reading’. This is a stem compound, since *bók* is uninflected. However, Harðarson (2017) points out that if you make the nonhead into a compound, and put inflection on that compound’s nonhead, then you also have to put inflection on the head as well, as in *nám-s-bók-a-lestur* ‘study-GEN-book-GEN-reading’ (=‘school book reading’); *\*nám-s-bók-lestur*, with no genitive on ‘book’, is ungrammatical.

The analysis in Alexiadou (2017b), Iordăchioaia et al. (2017) and Iordăchioaia (2019a) could be made to incorporate the Matching Condition. Recall that in their analysis, the nonhead is an nP in the object position, which raises to SpecnP for special (Case) licensing. We could assume that in Icelandic, a stem nonhead would work exactly like English. If, however, you merge a  $\phi$ P (an inflected nonhead), then it can’t move to SpecnP—it won’t be licensed there. Instead, the nominalizer has to project its own  $\phi$ P, and the nonhead will move to the specifier of that.



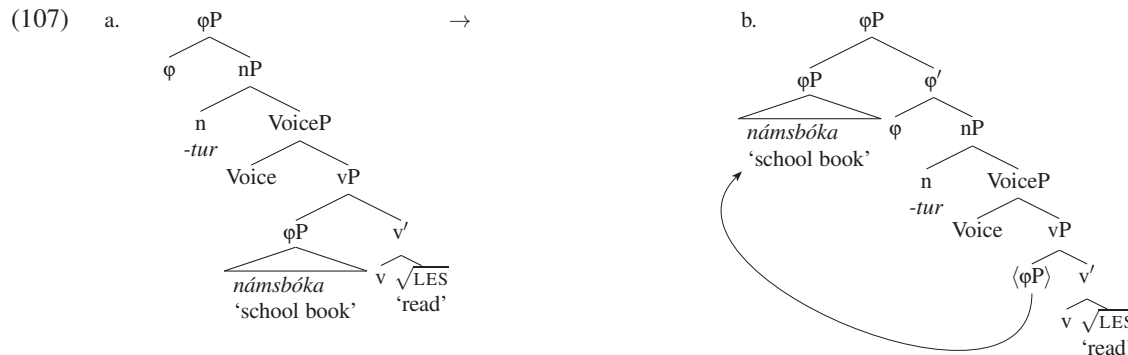

This seems to be in the general spirit of their analysis as well; in other cases, the structural size of the internal argument will force more or less structure in the head to license it.

However, the general picture points to the conclusion that we would expect dative on the nonhead for compounds headed by nominals derived from dative-assigning verbs. The  $\phi$  layer is syntactically relevant, and expresses contextually determined case features. And recall that we are interested here in morphological case, not licensing. There is no reason to think that the nonhead nP is “too small” to express morphological case—we see that it can in fact do exactly that.

I have focused here on the specific layering analysis of synthetic compounds in Alexiadou (2017b), Iordăchioaia et al. (2017) and Iordăchioaia (2019a), but the same applies to other analyses as far as I am aware. For example, Harley’s analysis, which is much closer to the Parallel Structures kind of analysis in some respects, relies on complex head formation, with each head incorporating its complement. She assumes that the verbal root takes the direct object complement. Under this analysis, it is hard to see how the matching analysis could be derived in the first place. One would have to say that a root taking a  $\phi$ P complement will somehow ultimately be forced to project up to  $\phi$ P.

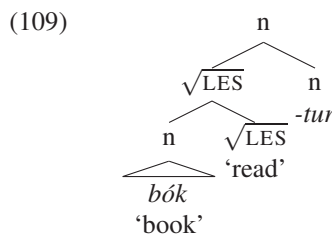
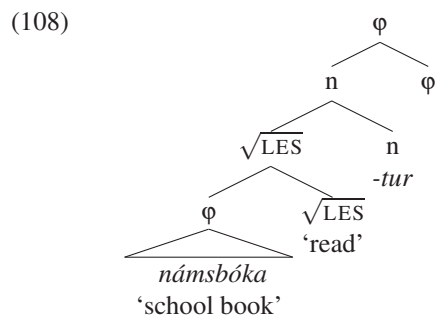

This analysis would not automatically predict dative case, since there is no verb. But as we saw earlier, there are some nominalizations that are derived from verbs with overt verbalizing morphology; such cases would have to have a verb in the structure, so once again, we would expect dative case to be possible.

These problems would not arise in Borer’s (2012) analysis, since she essentially takes synthetic compounds to be at the root level, below any functional structure. The entire compound would be formed below the verb, and conditions on that formation would be independent of the structure of synthetic compounding per se. However, the problem is that this analysis does not seem to make any predictions at all, and we do see substantial generalizations in the form and meaning of synthetic compounds which suggest that there must be some structure, and that that structure should contain morphosyntactic features of the relevant sort. Moreover, Alexiadou (2017b) provides numerous compelling arguments that synthetic compounds in fact do behave by and large like Complex Event Nominals, which is at odds with Borer’s analysis.

The present analysis does not face these problems, because, as above, the nonhead is not local to the case-determining head. The Matching Condition applies to synthetic compounds just as it does to primary compounds because both kinds of compounds are formed, structurally, in the same way. What is different about synthetic compounds is solely the interpretation of the deverbal head. I will discuss in more detail in chapter 5 exactly how this accounts for the differences between synthetic and primary compounds, and how we can also derive differences between phrasal CENs and synthetic compounds.

### 3.3 Summary

In this chapter, I have raised several Icelandic-specific morphosyntactic problems with the Phrasal Layering analysis of Icelandic nominalizations. First, the fact that nominalizations inherit argument structure but not any case-marking patterns is a major challenge to the phrasal layering analysis. We see this most sharply with dative themes, but problems arise with other case patterns as well. Second, the realization of the theme as an *á*-PP is particularly problematic, especially since it cannot plausibly be analyzed the way that English *of* is often analyzed. Third, the fact that verbs requiring the *-st* clitic can be nominalized, but that the clitic is nowhere to be seen, raises problems if we assume that verb phrases are nominalized. Finally, I showed that the same kinds of problems extend to synthetic compounds. I argued that the nonheads of such compounds have enough structure to show morphological case, and we would therefore expect them to be able to exhibit case-marking determined by the verb. It is fairly straightforward to see that these problems do not arise on a complex head analysis. However, it remains to show that the complex head analysis can account for the basic patterns of argument structure inheritance and ambiguity. This is the topic of chapters 5 and 6. First, however, I provide in chapter 4 another argument in favor of the complex head analysis, which is connected with an understanding of prepositional prefixing that the complex head analysis makes possible, which would be hard to account for under a phrasal layering analysis.

## Chapter 4

### Prepositions and prefixes

The discussion so far has focused primarily on verbs that take DP objects, whether those objects are nominative, accusative, dative or genitive. However, we have already encountered, in passing, some cases where a verb takes a PP complement. It turns out that such cases are quite interesting, theoretically, and form the basis of another argument in favor of the complex head analysis. This argument is somewhat more involved than the previous ones, however, in that it is connected to a range of patterns that we find in the nominalizations of PP-selecting verbs, and the analysis of these patterns that the complex head analysis allows. As I will discuss below, it is not clear how these patterns could be accounted for on a phrasal layering analysis.

When a verb that selects for a preposition is nominalized, we see at least three patterns, and these are illustrated in (1)–(3). Notice that for each of these cases, prefixing is not possible for the non-nominalized verb itself.

(1) **Pattern 1** (Prefixing and Doubling)

- a. að {\*um-} **ræða** {**um**} þetta  
to {\*about-} discuss {about} this  
'to discuss this'
- b. **um-ræð-a** **um** þetta  
about-discuss-NMLZ about this  
'discussion about this'

(2) **Pattern 2** (Prefixing Only, No Doubling)

- a. að {\*við-} **gera** {**við**} bílinn  
to {\*with-} do {with} car.the  
'to repair the car'
- b. **við-ger-ð** { á bílnum / bílsins / **\*við** bílinn }  
with-do-NMLZ { on car.the.DAT / car.the.GEN / \*with car.the }  
'repair of the car'

(3) **Pattern 3** (No Prefixing, PP only)

- a. að {\*um-} **hug-sa** **um** þetta  
to {\*about-} think-VBLZ about this  
'to think about this'
- b. **hug-s-un** Guðrúnar **um** þetta  
think-VBLZ-NMLZ Guðrún.GEN about this  
'Guðrún's thinking about this'

In the first pattern, the P selected by the verb gets prefixed to the nominalization, and may be repeated as the head of a PP to introduce the argument. In the second pattern, the P selected by the verb gets prefixed to the nominalization, but the argument it would have introduced is introduced by some other means (usually one of the more general strategies for themes). In the third pattern, there is no prefixing, and the noun selects the same P that the verb would have.

Why do we find these three patterns, and how do we understand the apparent inheritance of P-selection for the cases where that seems to happen? A phrasal layering analysis would straightforwardly lead us to expect that the derived

nominal would select the same preposition that the verb selects for, as in Pattern 3. It is less clear, at first glance, what to expect on a complex head analysis of the sort pursued in this book. Should selectional patterns be inherited by the n head when a v head adjoins to it? I would like to propose that we can understand this puzzle if we recast c-selectional restrictions as alloseme selection on roots (?Wood, 2016, 2017). The idea is that a PP complement can simultaneously do two things. First, it can make its own semantic contribution. Second, it can affect on the interpretation of the root of the selecting verb. Within a verb phrase, the P head can usually do both things at the same time. However, we see the functions split up in nominalizations: the prefix is involved in root alloseme selection, whereas the complement PP is contributing to the overall event phrase semantics.

The basic intuition guiding the general proposal is thus that these patterns reflect the “dual role” of prepositions for verb meaning. On the one hand, prepositions may have their own semantics (so ‘to’ means something different from ‘at’ or ‘from’), or not (so some prepositions may serve a purely formal purpose). On the other hand, prepositions may condition allosemy on the root. For example, *pick* means something different in *pick on someone* and *pick someone*; in the former case the meaning is something like ‘tease’, whereas the latter it is ‘choose’. I will propose that in nominalizations, a prefixed P serves the latter function, whereas a P heading a PP complement serves the former function. I will derive this pattern by proposing that prefixed prepositions adjoin to the derived, complex n head, and that this adjunction creates a locality domain for special meaning different from complementation (cf. Harðarson, 2016). When the preposition is in the complement of the derived nominal, it is too far away from the root to condition special meaning. This explanation entails that deverbal nominals can be built as complex heads directly, without any phrasal structure, as I am proposing in this book. As we will see, it is unclear how a phrasal layering analysis can capture these patterns, since the locality between the root and the preposition would be identical for all cases.

It may be worth noting at this point that in Icelandic, many verbs are built by prefixing a preposition to them. An example is presented in (4) below, and we will see further examples in section 4.2.

- (4) Peir **að**-laga meðferðina **að** sjúklingunum.  
 they to-adapt treatment.the.ACC to patient.the.DAT  
 ‘They adapt the treatment to the patient.’

A common analysis of P-prefixing cross-linguistically claims that such prefixes originate in the complement of the verb, and attach to the verb by movement (e.g. Svenonius 2004; Biskup 2007; Acedo-Matellán 2010; Myler 2011, 2013; Biskup & Putnam 2012; Wood 2015). However, while such cases will play a role in what follows, the primary interest in this chapter is in examples like (1)–(3), where the verb cannot take a prefix, while the noun derived from it must. For those cases, I will argue that a movement account is undesirable, as it is unable to explain why we find the patterns of (non-)prefixation and (non-)doubling that we find (cf. McIntyre 2018).

#### 4.1 Proposal: Structural constraints on allosemy

The basic picture that I propose is one where adjunction to a complex head and complementation to a complex head create different locality domains for the conditioning of special meaning. First, I will present the basic claim schematically. Consider the verb structures in (5):

- (5) a. **P in Complex Head**

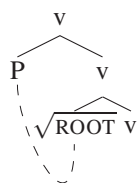

- b. **P in Complement**

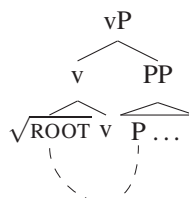

In (5a), P is adjoined to the complex v head, whereas in (5b), P heads a PP complement of the complex v head. In both of the structures in (5), P can condition special meaning on the root—whether it is adjoined to the complex v head or heads the complement PP. Now consider the derived nominal structures in (6).

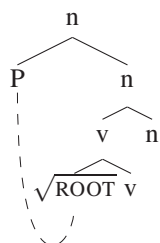
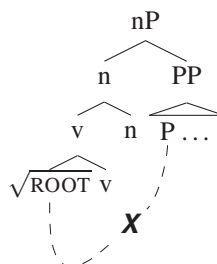
(6) a. **P in Complex Head**b. **P in Complement**

In (6), P can condition special meaning on the root only when it is in the complex head, not when it heads the complement PP.<sup>1</sup> Let us try to flesh out why this is.

Assume that adjunction creates segments of a category, and that, following Kayne (1994, 16), segments do not enter into c-command relations. We define c-command as follows:

- (7) X c-commands Y iff X and Y are categories and X excludes Y and every category that dominates X dominates Y. (Kayne, 1994, 16)

Given this, the crucial difference between (6a) and (6b) is that n c-commands P in (6b) but not in (6a).

(8) a. **C-command relations in (6a)**

$P \gg \sqrt{\text{ROOT}} \gg v \gg n$   
 $\sqrt{\text{ROOT}} \gg v \gg P$

b. **C-command relations in (6b)**

$\sqrt{\text{ROOT}} \gg v \gg n \gg P$

If we assume that v and n are both phase heads, there are two phase heads intervening between  $\sqrt{\text{ROOT}}$  and P in (6b) but only one in (6a) and (5b). Why should this matter? Let us now turn to our assumptions about special meaning.

First, we assume that the complement of a verb must be able to affect the meaning of the verb root. This seems to be a basic empirical fact that any theory must be able to reckon with. Second, we assume that special meaning is subject to some kind of phase locality (Marantz, 2013a), and that n and v are phase heads. As for the nature of the phase locality, Embick (2010) argues that a morphological dependency may cross no more than one phase head, and I assume that allosemy should work the same way. We can now see why one vs. two phase heads matters. In (5b) and (6a), only v intervenes between P and the  $\sqrt{\text{ROOT}}$ , so allosemy is possible. In (6b), v and n intervene between P and the  $\sqrt{\text{ROOT}}$ , so allosemy is not possible. Adjoining P to n means that n does not c-command P, and thus does not intervene between P and the  $\sqrt{\text{ROOT}}$ .

The empirical consequences of this proposal are as follows. First, when P and  $\sqrt{\text{ROOT}}$  must be visible to each other for conditioning root meaning, prefixing will be obligatory in nominalization. If (9a) is not an option, (9b) will be required.

## (9) a.

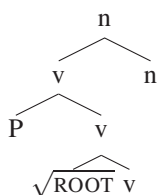

## b.

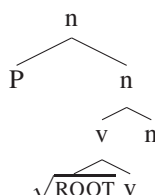

Second, (6b) will only be possible when P makes its own semantic contribution, and does not condition special meaning on the root. Third, doubling will arise when P makes its own semantic contribution *and* conditions special meaning on the root. This involves separate uses of the same P.<sup>2</sup>

<sup>1</sup> As currently formulated, a truly denominal or deadjectival verb should not be able to get a special meaning conditioned by a PP complement; I have not examined this prediction closely, but the discussion of *-væða* verbs in section 6.5 in chapter 6 seems to provide some initial support.

<sup>2</sup> The analysis thus also predicts, correctly as we will see, that the two instances of P need not be identical.

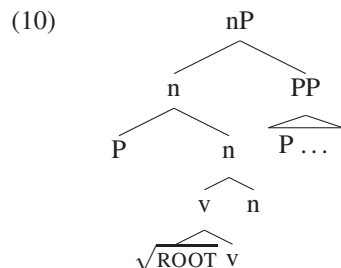

Importantly, note that all three patterns are possible with a CEN reading, as briefly illustrated in (11) and (12) for patterns 1 and 2, respectively (see (50b) below for pattern 3). In these examples, we see telicity PPs ((11a) and (12a)), eventive modifiers ((11b) and (12a)), an agentive modifier (the instrument phrase in (12b)), and an external argument interpretation of the genitive (all examples).

- (11) a. að-hlynn-ing Guðrúnar að sjúklingnum í 10 ár  
to-tend-NMLZ Guðrún.GEN to patient.the for 10 years  
'Guðrún's tending to the patient for 10 years'
- b. endurtekin á-bend-ing nemandans á skekkjurnar  
repeated on-point-NMLZ student.the.GEN on errors.the.ACC  
'the student's repeated pointing out of the errors'
- (12) a. { stöðug / endurtekin } við-vör-un Guðrúnar á hættunni (í tíu ár)  
{ constant / repeated } with-warn-NMLZ Guðrún.GEN on danger.the.DAT (for ten years)  
'Guðrún's {constant/repeated} warning of the danger (for ten years)'
- b. við-ger-ð Guðrúnar á bílnum mínum með sleggju  
with-do-NMLZ Guðrún.GEN on car.the.DAT my with sledge.hammer  
'Guðrún's repairing of my car with a sledge hammer'

Moreover, it is equally important to note that on the CEN reading, the derived noun still appears to inherit its meaning and argument structure from the underlying verb; that is, Borer's Generalization holds of the P-prefix derived nominals discussed in this book, even when an idiosyncratic meaning of the root is conditioned by the presence of the preposition. Consider, for example, the noun *við-ger-ð* 'repair'. Here, *við* conditions a special meaning of the root; however, this is the same special meaning that exists in the verb phrase (*gera við* 'repair') where *við* is not a prefix, but heads its own PP. Thus, the noun *viðgerð* in the CEN reading seems to inherit its meaning from the verb phrase.

I now turn to a brief discussion of prefixing to verbs, in order to set the stage for the argument for taking P to adjoin to the n head directly.

## 4.2 Prefixing to verbs

I first note that Icelandic does not freely or productively prefix prepositions to verbs. Moreover, prepositional prefixing is not "separable" in the Germanic sense; once something is a prefix, it stays with the verb. It is a very common phenomenon, but it is also very "lexicalized"—whether it happens depends on the particular verb and preposition in a rather unpredictable manner. Consider the following examples, adapted in part from Bjarnadóttir (2005, 119).

(13) **Prefixing Obligatory**

|            |              |               |
|------------|--------------|---------------|
| aðfrævast  | *frævast að  | ‘pollinate’   |
| afbaka     | *baka af     | ‘distort’     |
| afeitra    | *eittra af   | ‘detoxicate’  |
| framreikna | *reikna fram | ‘extrapolate’ |
| tileinka   | *einka til   | ‘dedicate’    |
| umbera     | *bera um     | ‘tolerate’    |

**Prefixing Optional**

|           |            |             |
|-----------|------------|-------------|
| aðgæta    | gæta að    | ‘examine’   |
| aðlaga    | laga að    | ‘adapt’     |
| afgirða   | girða af   | ‘fence off’ |
| framreiða | reiða fram | ‘serve’     |

**Prefixing Impossible**

|            |            |               |
|------------|------------|---------------|
| *aðdást    | dást að    | ‘admire’      |
| *aðfinna   | finna að   | ‘criticize’   |
| *afganga   | ganga af   | ‘remain’      |
| *framdraga | draga fram | ‘emphasize’   |
| *tilslá    | slá til    | ‘agree to do’ |
| *umræða    | ræða um    | ‘discuss’     |

All of these verbs require prefixing in some deverbal form (whether it is a deverbal noun, adjective, etc.). However, as for the verbs themselves, we see examples where prefixing to the verb itself is obligatory, optional, or impossible. In this chapter I will be particularly interested in cases of the third sort (where prefixing to the verb is impossible), but the other two classes will inform the discussion as well.

I suggest two basic structures for prefixing of prepositions to verbs, which are shown in (14). Drawing inspiration from the analysis of Greek synthetic compounds in Iordăchioaia et al. (2017) (see also Iordăchioaia 2020b for a similar application to English particle verbs and their nominalizations), I assume that these structures correspond to specific properties, which are listed below each structure.

(14) a.

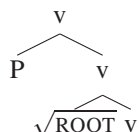

b.

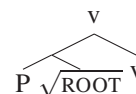

- An independent verb will exist, without the prefix.
- The independent verb will belong to the same inflectional class and show the same (ir)regular inflectional paradigm.
- P may condition a special (unpredictable) meaning of the root.
- There may be no independently existing verb, without the prefix.
- If there is an independent verb, it may not belong to the same inflectional class and show the same (ir)regular inflectional paradigm.
- P may condition a special (unpredictable) meaning of the root.

To the extent that (14a) and (14b) are distinguishable, I will mostly stay away from (14b), noting that this essentially involves the creation of a morphologically complex root. We will see some examples of prefixing to verbs in what follows. Two examples are shown, along with their nominalizations, in (15)–(16). Unsurprisingly, the P that is prefixed to the verb is also present in the nominal derived from the verb.

- (15) a. Pósturinn af-henti frúnni pakkann.  
postman.the.NOM off-tossed lady.the.DAT package.the.ACC  
‘The postman delivered the package to the lady.’
- b. Af-hend-ing pakkans fór fram í gær.  
off-toss-NMLZ package.GEN went forth yesterday  
‘The delivery of the package happened yesterday.’

(Jóhannsdóttir, 1995, 65)

- (16) a. Konan á-sakaði manninn (um framhjáhald).  
 woman.the.NOM on-blamed man.the.ACC about adultery  
 ‘The woman accused the man (of adultery).’  
 b. Á-sök-un konunnar var réttmæt.  
 on-blame-NMLZ woman.the.GEN was rightful  
 ‘The woman’s accusation was rightful.’ (Jóhannsdóttir, 1995, 66)

One question that arises is whether the structures in (14) are base-generated, as I am proposing for nouns, or derived from head movement of a P in the complement of *v*. I will not take a strong stance on this here, although it is quite possible that both options exist. Considerations bearing on the issue would take us far outside the scope of the present work. I will mention here only two. First, if a P is prefixed by movement from a complement, we might expect it to assign the same case to its complement that it would have in the absence of such movement. Second, the presence of P heading a phrase might be motivated if its specifier (or a specifier in its extended projection) is needed to provide a syntactic slot for some argument. A brief discussion of these issues as they pertain to Icelandic can be found in Wood (2015, 283–290).

However, the primary point of interest will be cases where prefixing is only possible in nouns derived from verbs. In these cases, movement from a phrasal position is not motivated, as we will see. Moreover, the considerations mentioned above do not, as far as I know, motivate movement from a phrasal PP complement. We do not see cases where, say, a dative assigning P is prefixed to a noun and conditions the case on the complement of the noun. We also do not see constructions where the derived noun takes two arguments (or an argument and an *-st* clitic), with one of them corresponding to the specifier of a PP. For these reasons, I leave open the possibility that some verb prefixes might be derived by head movement, while still claiming that prefixes in derived nominals are not.

In principle, a large number of prepositions—maybe all simplex ones—can be prefixed at least sometimes. Some examples are presented in (17) below:

| (17) |                      | Verb Prefix                      | Deverbal Only                      |
|------|----------------------|----------------------------------|------------------------------------|
| a.   | <i>að</i> ‘to/at’    | <i>að-vara</i> ‘warn’            | <i>að-dáun</i> ‘admiration’        |
| b.   | <i>af</i> ‘from’     | <i>af-henda</i> ‘deliver’        | <i>af-lestur</i> ‘reading’         |
| c.   | <i>á</i> ‘on’        | <i>á-kveða</i> ‘decide’          | <i>á-bending</i> ‘indictation’     |
| d.   | <i>eftir</i> ‘after’ | <i>eftir-láta</i> ‘leave behind’ | <i>eftir-vænting</i> ‘expectation’ |
| e.   | <i>frá</i> ‘from’    | <i>frá-biðja</i> ‘reject’        | <i>frá-saga</i> ‘story’            |
| f.   | <i>fyrir</i> ‘for’   | <i>fyrir-bjóða</i> ‘forbid’      | <i>fyrir-lestur</i> ‘lecture’      |
| g.   | <i>upp</i> ‘up’      | <i>upp-fylla</i> ‘fulfull’       | <i>upp-lestur</i> ‘recital’        |
| h.   | <i>um</i> ‘about’    | <i>um-orða</i> ‘paraphrase’      | <i>um-fjöllun</i> ‘discussion’     |
| i.   | <i>úr</i> ‘out of’   | <i>úr-elda</i> ‘decommission’    | <i>úr-felling</i> ‘omission’       |
| j.   | <i>við</i> ‘with’    | <i>við-hafa</i> ‘use’            | <i>við-ræður</i> ‘conversation’    |
| k.   | <i>yfir</i> ‘over’   | <i>yfir-drífa</i> ‘exaggerate’   | <i>yfir-drottun</i> ‘dominancy’    |

I now turn to the patterns we find in nominals derived from verbs that take PP complements.

## 4.3 Prefixing to derived nominals

### 4.3.1 Pattern 1: Prefixing and doubling

We turn to the first pattern mentioned above. In this pattern, a verb takes a PP complement. In the noun derived from this verb, the preposition must be prefixed to the noun. The preposition may then be doubled to express the argument of the original PP. Consider the verb *benda*, which has a compositional meaning ‘point at’ (physical gesture) and a more idiosyncratic meaning ‘indicate/point out’.

- (18) a. Það er dónalegt að **benda á** ókunnugt fólk.  
 it is rude to point on unknown people.ACC  
 ‘It is rude to point at strangers.’<sup>3</sup>

<sup>3</sup> Example from *snara.is*.



- b. Nemandinn **benti** á skekkjuna.  
 student.the.NOM pointed on mistake.the.ACC  
 'The student pointed out the mistake.'

The physical gesture meaning can occur with or without *á*, but the non-gesture meaning requires *á*. In (19), without the preposition, the meaning can only refer to the gesture.

- (19) Ekki benda!  
 not point  
 'Don't point!'  
 = 'Don't make the pointing gesture'  
 ≠ 'Don't make observations'

The preposition cannot be prefixed to the verb, whether we repeat it or not.

- (20) \*Nemandinn **á-benti** (á) skekkjuna.  
 student.the.NOM on-pointed (on) mistake.the.ACC  
 'The student pointed out the mistake.'

According to the view adopted here, this means that neither of the structures in (14) can be contained in the derived nominal structure.

When the verb is nominalized, the non-gesture meaning requires the preposition to prefix to the nominal.

- (21) \***Bend-ing-in** á skekkjuna kom sér vel fyrir kennarann.  
 point-NMLZ-the on mistake.the.ACC came REFL well for teacher.the
- (22) **Á-bend-ing-in** á skekkjuna kom sér vel fyrir kennarann.  
 on-point-NMLZ-the on mistake.the.ACC came REFL well for teacher.the  
 'The pointing out of the mistake was good for the teacher.'

(Jóhannsdóttir, 1995, 71)

I propose the structure in (23) for the noun phrase in (22):

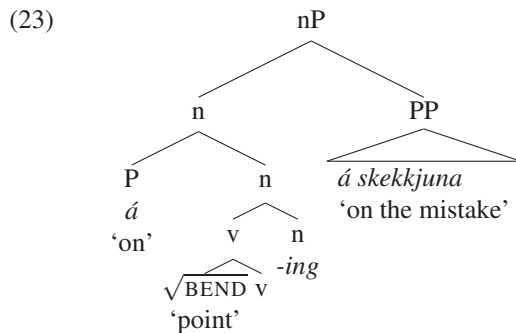

The prefixing conditions the appropriate meaning of the root. Without the prefix, the noun *bending* exists, but it refers to a gesture, as in (24).

- (24) meintar bend-ing-ar hans til áhorfenda  
 alleged point-NMLZ-PL his to viewers  
 'his alleged gestures to the audience'<sup>4</sup>
- (25) Guðrún benti á kennarann.  
 Guðrún pointed to teacher.the.ACC  
 'Guðrún pointed at the teacher.'

<sup>4</sup> Example from RMH.

- (26) % *bending* Guðrúnar á kennarann (kom á óvart)  
pointing Guðrún.GEN to teacher.the.ACC (came on surprise)  
'Guðrún's pointing at the teacher (was surprising).'<sup>5</sup>

As shown in the above examples and represented in the structure in (23), the prefixed preposition can also be repeated. This is because it also contributes its own (directional) meaning. The meaning is vague enough that doubling is not obligatory for all speakers. Some require it, but others allow the argument to be expressed in the genitive.<sup>6</sup>

- (27) % *Á-bend-ing* skekkjunnar kom sér vel fyrir kennarann.  
on-point-NMLZ mistake.the.GEN came REFL well for teacher.the  
'The pointing out of the mistake was good for the teacher.'

Some other cases of doubling, where prefixation cannot have a verbal source, are shown in (28)–(31):

- |         |                                                                                                                                    |    |                                                                                                                                                                      |
|---------|------------------------------------------------------------------------------------------------------------------------------------|----|----------------------------------------------------------------------------------------------------------------------------------------------------------------------|
| (28) a. | <i>að</i> { *um- } <b>ræða</b> { <b>um</b> } þetta<br>to { *about- } discuss { about } this<br>'to discuss this'                   | b. | <b>um-ræð-a</b> <b>um</b> þetta<br>about-discussion-NMLZ about this<br>'discussion about this'                                                                       |
| (29) a. | <i>að</i> { *við- } <b>bregðast</b> { <b>við</b> } þessu<br>to { *with- } react { with } this<br>'to react to this'                | b. | <b>við-brögð-Ø</b> <b>við</b> þessu<br>with-react-NMLZ with this<br>'reaction to this'                                                                               |
| (30) a. | <i>að</i> { *í- } <b>kveikja</b> { <b>í</b> } húsinu<br>to { *in- } ignite { in } house.the<br>'to set the house on fire'          | b. | <b>í-kveikj-a</b> <b>í</b> húsum (er stranglega bönnuð)<br>in-ignite-NMLZ in houses (is strictly prohibited)<br>'setting of houses on fire (is strictly prohibited)' |
| (31) a. | <i>að</i> { *að- } <b>hlynn</b> a { <b>að</b> } sjúklingnum<br>to { *to- } attend { to } patient.the<br>'to attend to the patient' | b. | <b>að-hlynn-ing</b> <b>að</b> sjúklingnum<br>to-tend-NMLZ to patient.the<br>'tending to the patient'                                                                 |

For a related version of this doubling pattern, consider the verbs in (32):

- |         |                                                                                                                              |    |                                                                                                                                  |
|---------|------------------------------------------------------------------------------------------------------------------------------|----|----------------------------------------------------------------------------------------------------------------------------------|
| (32) a. | Þeir <b>laga</b> sig <b>*(að)</b> breytingunum.<br>they adapt REFL.ACC *(to) changes.the.DAT<br>'They adapt to the changes.' | b. | Þeir <b>að-laga</b> sig <b>(að)</b> breytingunum.<br>they to-adapt REFL.ACC (to) changes.the.DAT<br>'They adapt to the changes.' |
|---------|------------------------------------------------------------------------------------------------------------------------------|----|----------------------------------------------------------------------------------------------------------------------------------|

In this case, we see that the P must be overtly realized somewhere, but it needn't be prefixed to the verb. If it is not prefixed, it is obligatorily overt as the head of a separate PP. If it is prefixed, it may or may not also be realized overtly as the head of a separate PP. Now consider what happens if it is nominalized, as illustrated in (33).

- |         |                                                                                                                  |
|---------|------------------------------------------------------------------------------------------------------------------|
| (33) a. | <b>að-lög-un</b> <b>*(að)</b> breytingunum<br>to-adapt-NLMZ *(to) changes.the.DAT<br>'adaptation to the changes' |
| b.      | <b>*lög-un</b> <b>(að)</b> breytingunum<br>to-adapt-NLMZ (to) changes.the.DAT                                    |
| c.      | <b>*lög-un</b> breytinganna<br>to-adapt-NLMZ changes.the.GEN                                                     |

Here, in the nominal—unlike the verb—we see that prefixing *and* doubling is obligatory: the only acceptable structure is the one with the prefix and the overt PP head. Why might this be? Consider the structure of the verb phrase without prefixing:

<sup>5</sup> Note that some speakers find this CEN use of *bending* to be perfectly acceptable, but other speakers find it odd or degraded.

<sup>6</sup> Speakers seem to vary in their judgment of (22). Jóhannes Gísli Jónsson finds the example unacceptable. Dagbjört Guðmundsdóttir and Einar Freyr Sigurðsson find it possible, but prefer examples with the preposition *um* 'about' instead (see discussion surrounding example (46) below). Halldór Sigurðsson points out that for him, *ábending á skekkjuna* 'awkward, but maybe just stylistically,' but that he doesn't find that it is clearly better than *ábending skekkjunnar* (as in (27)).

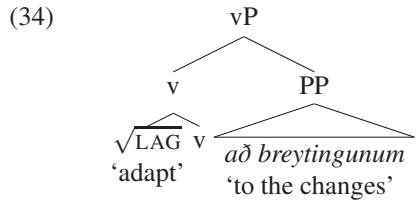

In this structure, the preposition *að* determines/conditions the meaning of the root  $\sqrt{\text{LAG}}$ . Without *að*, the root  $\sqrt{\text{LAG}}$  can still form a verb, but with the meaning ‘fix/repair’.

- (35) Hjólið er bilað, geturðu lagað það fyrir mig?  
 bike.the is broken can.you fix it.ACC for me  
 ‘The bike is broken, can you fix it for me?’<sup>7</sup>

Likewise, the nominal *lögun*, without prefixing, is possible, but it means ‘fix/repair’, not ‘adapt’. The ‘adapt’ meaning is impossible in the nominal without the prefix.

- (36) lög-un-in á stólnum  
 fix-NMLZ-the on chair.the.DAT  
 ‘the fixing of the chair’

Consider what the structure would look like, according to the present proposal:

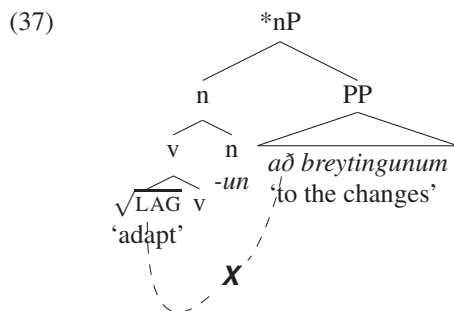

In this structure, the preposition is too far away from the root to condition the ‘adapt’ meaning. In contrast, adjunction—either to *v* as in (38) or to *n* as in (39)—brings it close enough.<sup>8</sup>

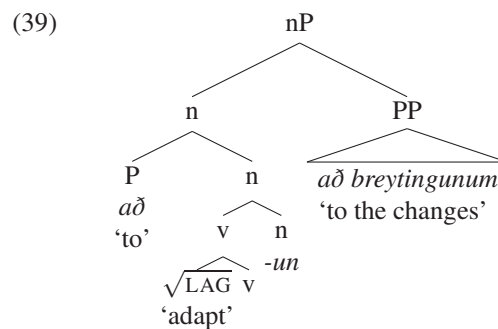
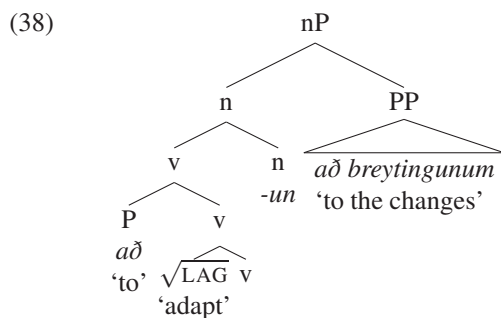

Once again, the preposition can be doubled in the PP because *að*, in addition to conditioning special meaning, has clear directional meaning of its own. In this case, the directional meaning is important enough to the overall meaning that as far as I know, the argument of P cannot be expressed without the preposition.

- (40) \*að-lög-un breytinganna  
 to-adapt-NLMZ changes.the.GEN

<sup>7</sup> Example from snara.is.

<sup>8</sup> Since *v* is an option, (38) may seem the most likely option. However, since prefixing to *v* is not obligatory, (39) is just as possible, and it is also possible that the word is arbitrarily ambiguous between the two structures.

### 4.3.2 Pattern 2: Prefixing only

In the second pattern, we also see cases where the nominal forces prefixation, but doubling does not occur. In these cases, the preposition's sole (semantic) purpose is to condition the interpretation of the root. Consider the examples in (41):

- (41) a. Guðrún **gerði við** bílinn.  
 Guðrún did with car.the.ACC  
 'Guðrún repaired the car.'
- b. \*Guðrún **við-gerði (við)** bílinn.  
 Guðrún with-did with car.the.ACC  
 INTENDED: 'Guðrún repaired the car.'

Here the verb *gera* 'do', when combined with the preposition *við* 'with', means 'repair/fix'. This meaning is only available with the preposition, and the preposition cannot be prefixed to the verb. As in Pattern 1, however, in the nominalization, prefixation of the preposition is obligatory for this meaning to obtain.

- (42) a. \*ger-ð { á bílnum / bílsins / við bílinn }  
 do-NMLZ { on car.the.DAT / car.the.GEN / with car.the }  
 INTENDED: 'repair of the car'<sup>9</sup>
- b. við-ger-ð { á bílnum / bílsins / \*við bílinn } tók langan tíma  
 with-do-NMLZ { on car.the.DAT / car.the.GEN / \*with car.the } took long time  
 'Repair of the car took a long time.'

Unlike in Pattern 1, however, the preposition may not be doubled. Instead, its argument can be expressed in one of the "default" nominalization ways, such as with semantically vacuous *á*-PP or with a genitive DP (for some speakers).<sup>10</sup> According to the present proposal, this is because *við* does not contribute anything semantically in *gera við* 'fix'; rather, it conditions the meaning of the verb(al) root. As before, the nominal *gerð* is well-formed with other meanings, such as 'make (of a car)', 'design', 'structure', 'version', 'act', etc.

To emphasize the main point, the head of a complement PP is close enough to the root in the vP structure to have this meaning effect, but not in the nominal.

- (43) a. P may condition root meaning

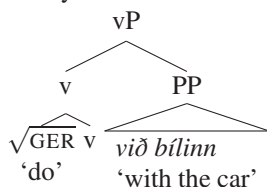

- b. P may not condition root meaning

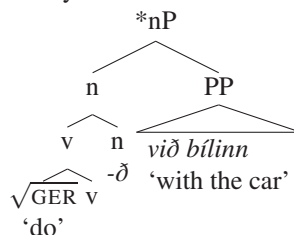

Adjunction of P to n, as shown in (44), brings P close enough to the root to condition special meaning.

- (44) P may condition root meaning

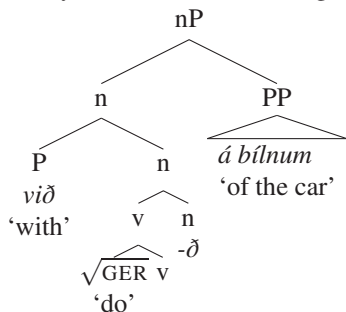

<sup>9</sup> This string may be grammatical with other readings.

<sup>10</sup> Not all speakers accept the genitive here, but some do, and attested examples can be found.

In effect, the present proposal says that there is no P doubling, and when prepositional selection seems to be inherited in a complement PP, that is only because the P is contributing some meaning of its own. This leads us to expect that in some cases, we will simply see distinct prepositions. And in fact we find this. Consider the examples with *á-bending* ‘indication’ from above.

- (45) **á-bend**-ing-in **á** skekkjuna  
 on-point-NMLZ-the on mistake.the.ACC  
 ‘the pointing out of the mistake’

Einar Freyr Sigurðsson (p.c.) points out to me that for him, while (45) is possible, another option is (46), with the distinct preposition *um* ‘about’.

- (46) **á-bend**-ing-in **um** skekkjuna  
 on-point-NMLZ-the about mistake.the.ACC  
 ‘the pointing out of the mistake’

This makes sense, because if the P *á* ‘on’ is prefixed, then *á* isn’t strictly necessary in the PP for the purposes of constructing verb meaning.<sup>11</sup> Nevertheless, the *prefixing* of *á* ‘on’ is necessary, and *um* ‘about’ cannot serve this function.

- (47) \* { bend-ing / um-bend-ing } um skekkjuna  
 { point-NMLZ / about-point-NMLZ } about mistake.the

What this shows is that the P *um* can serve the secondary, semantic role of introducing the argument, but it is not involved in conditioning root meaning.

Two more examples of this pattern involve the verbs *dást að* ‘admire (to)’ and *annast um* ‘take care of’, which are nominalized as *aðdáun* and *umönnun*, respectively.<sup>12,13</sup> For both, P must be prefixed to the noun, but cannot be repeated in the complement of the derived noun.

- (48) a. Guðrún { \*að- } dáðist { **að** } Maríu.  
 Guðrún { \*to- } admired { to } María  
 ‘Guðrún admired María.’  
 b. **að**-dá-un Guðrúnar { **á** / \***að** } Maríu  
 to-admire-NMLZ Guðrún.GEN { on / \*to } María  
 ‘Guðrún’s admiration of María.’  
 c. \* dá-un Guðrúnar { **á** / **að** } Maríu  
 admire-NMLZ Guðrún.GEN { on / to } María
- (49) a. Hún { \***um**- } **ann**-aðist ( **um** ) barnið.  
 she { \*of- } take.care-PST ( of ) child.the  
 ‘She took care of the child.’  
 b. **um**-önn-un-in { **á** barninu / \***um** barnið }  
 of-take.care-NMLZ-the { on child.the.DAT / \*of child.the.ACC }  
 ‘the taking care of the child’  
 c. \* **önn**-un-in { **á** barninu / **um** barnið }  
 take.care-NMLZ-the { on child.the.DAT / of child.the.ACC }

<sup>11</sup> See also Merchant (2019), who argues for English that categorial heads, rather than roots, select PP complements, so that apparent inheritance of P-selection is only apparent.

<sup>12</sup> Note that most speakers prefer to leave the preposition *um* out with *annast*, and some find *um* better with a verb phrase like *annast um málið* ‘take care of the issue’. Some report a possible meaning difference, where the event is more of an activity when the preposition is present. One possibility is that the preposition is actually always present syntactically, but sometimes null, as proposed for certain other transitive *-st* verbs by Wood (2015, 285–290); see especially the discussion of the NOM-ACC verbs *forðast* ‘avoid’, *undirgangast* ‘undertake’, *umgangast* ‘associate with’ and *áfellast* ‘blame’ (Wood, 2015, 289). The judgments of the nominal form *umönnun* are consistent across speakers.

<sup>13</sup> Note that the underlying form of the root in *umönnun* is *ann-*, just like with the verb *annast*, but the /a/ becomes /ö/ by the regular *u*-umlaut rule, on which see footnote 12 in chapter 2.

- d. **um-önn-un** barnsins  
of-take.care-NMLZ child.the.GEN  
'the taking care of the child'
- e. \* **önn-un** barnsins  
take.care-NMLZ child.the.GEN

### 4.3.3 Pattern 3: Nominal selects the same PP

In the final pattern that we see, the derived noun selects the same preposition that the verb it is based on selects, but there is no prefixing at all. In such cases, the preposition only contributes meaning of its own, and does not condition any special meaning on the root. We see an example of this pattern with the verb *hugsa* 'think' in (50).

- (50) a. Guðrún hug-sa-ði **um** þetta.  
Guðrún think-VBLZ-PST about this  
'Guðrún thought about this.'
- b. hug-s-un Guðrúnar **um** þetta (í tvo tíma) (truflaði vin hennar)  
think-VBLZ-NMLZ Guðrún.GEN about this (for two hours) (bothered friend her)  
'Guðrún's thinking about this (for two hours) (bothered her friend)'
- c. hug-s-un-in **um** þetta  
think-VBLZ-NMLZ-the about this  
'the thinking about this'

The verb *hugsa* 'think' may select a PP headed by *um* 'about', like *ræða* 'discuss' above. But unlike *ræða* 'discuss', when *hugsa* 'think' is nominalized, the preposition need not be prefixed to the derived noun.<sup>14</sup> The reason is that the preposition, in this context, is not needed to condition any special meaning on the verb. The meaning of the preposition *um* 'about' in this use, is quite general, found with many verbs and nouns, in uses corresponding fairly well to the English preposition 'about'. Moreover, *hugsa* 'think' can occur without the preposition and happily retain its basic meaning.

- (51) Guðrún er ennþá að hug-sa.  
Guðrún is still to think-VBLZ  
'Guðrún is still thinking.'

Similar observations can be made about other examples. The verb *færast* 'move' may select a directional preposition like *í* 'into', with a predictable meaning. When nominalized, this preposition may head the complement of the derived nominal without prefixing to it.

- (52) a. Ákveðnilíðir færast í frumlagssæti.  
determiner.phrases move into subject.position  
'Determiner phrases move into subject position.'
- b. fær-sla ákveðnilíða í frumlagssæti  
move-NMLZ determiner.phrases.GEN into subject.position  
'the movement of determiner phrases into subject position'

As above, the verb has no special meaning that depends on the preposition. The same holds for *træðka* 'trample' with locative *á* 'on'.

- (53) a. Þeir tröð-ku-ðu á vilja þingsins.  
they trample-VBLZ-PST on will parliament.the.GEN  
'They trampled on the will of the parliament.'

<sup>14</sup> We will see below that prefixing *um* 'about' is in fact not ungrammatical, but it results in a different meaning.

- b. tröð-k-un á vilja þingsins (er óþolandi )  
trample-VBLZ-NMLZ on will parliament.the.GEN (is intolerable )  
'Trampling on the will of the parliament (is intolerable).'
- c. tröð-k-un almennings á vilja þingsins  
trample-VBLZ-NMLZ public.GEN on will parliament.the.GEN  
'the public's trampling on the will of the parliament'
- d. tröð-k-un-in á vilja þingsins  
trample-VBLZ-NMLZ-the on will parliament.the.GEN  
'the trampling on the will of the parliament'
- e. \*tröð-k-un vilja þingsins  
trample-VBLZ-NMLZ will parliament.the.GEN  
INTENDED: 'the trampling on the will of the parliament'

Consider also the case of the verb *langa* 'want'. It may select a PP object headed by *í* 'in'. When it is nominalized, this preposition is retained, along with the same basic meaning of the verb, without any prefixing.

- (54) a. Guðrúnu langar í vín.  
Guðrún.ACC wants in wine  
'Guðrún wants wine.'
- b. löng-un hennar í vín  
want-NMLZ her in wine  
'her desire for wine'

From an English perspective, this may seem different from the cases above, with the use of *í* 'in' seeming more idiosyncratic. However, it is less surprising within the general system of Icelandic. First of all, note that as above, the *í* 'in' is not necessary for the basic meaning of the verb.

- (55) Guðrúnu langar að fara.  
Guðrún.ACC wants to leave  
'Guðrún wants to leave.'

This supports the present explanation for why prefixing is not needed: the verb root does not need to 'see' the preposition to get its meaning. Moreover, *í* 'in' is used much more generally in Icelandic than in English to introduce (generally unaffected) themes.

- (56) a. að ná í myndirnar  
to get in pictures.the  
'to get the pictures' (Hilmisdóttir, 2007, 103)
- b. að sparka í vegginn  
to kick in wall.the  
'to kick the wall'
- c. að pota í einhvern  
to poke in someone  
'to poke someone'
- d. að hringja í einhvern  
to call in someone  
'to call someone'

Thus, the preposition *í* 'in' is not getting a special use or meaning conditioned by the verbal root of *langa* 'want'; its use reflects a more general use that is found in the language.

As mentioned above, prefixing is not necessarily ungrammatical with nominals of this sort. The preposition *um* 'about' can be prefixed to *hugsun* 'thinking', but then it gets a different meaning. Instead of general thinking, it refers

to ‘pondering’—really thinking, reflecting, taking one’s time, etc. The preposition *um* generally cannot be prefixed to the verb, however.<sup>15</sup>

- (57) a. \*Guðrún um-hug-sa-ði (um) þetta.  
 Guðrún about-think-VBLZ-PST (about) this  
 INTENDED: ‘Guðrún pondered (about) this.’
- b. um-hug-s-un Guðrúnar um þetta  
 about-think-VBLZ-NMLZ Guðrún.GEN about this  
 ‘Guðrún’s pondering about this’

This reading is possible with a non-nominalized verb phrase *að hugsa sig um*, literally ‘to think REFL.ACC about’, which means ‘to ponder’. Here, *um* is a particle which does not prefix to the verb, and the direct object is a reflexive pronoun.

#### 4.3.4 The ‘gratuitous prefixing’ effect

For examples which do not have an established special meaning, speakers’ reactions to the prefixing for derived nouns where it is unnecessary, which we might refer to as ‘gratuitous prefixing’, are revealing. Consider first *færsla* ‘movement’, which as we saw above does not need a prefix.

- (58) (?? í-)fær-sla ákveðniliða í frumlagssæti  
 (?? in-)move-NMLZ determiner.phrases.GEN into subject.position  
 ‘the movement of determiner phrases into subject position’

When asked whether prefixing was nevertheless possible, speakers gave a variety of reactions. Some simply rejected it outright. Others said it was weird, but not necessarily impossible. One speaker said they felt like it meant something “more specific,” but could not say exactly what. Another said one “could make it mean something new” if one needed to. Yet another, after rejecting it, said it would be “a separate noun” and suggested that maybe it would be better in a separate context. Essentially the same range of reactions was found for prefixing of *á* ‘on’ to *tröðkun* ‘trampling’ and *í* ‘in’ to *löngun* ‘wanting/desire’. In fact, *í-löngun* is attested and can be found in the dictionary on snara.is.

The speakers I consulted found it unusual however, some rejecting it, others saying it was strange but grammatical, etc. This is in sharp contrast to the reactions speakers gave to examples where prefixing is needed to condition special meaning. There, speakers judged examples without the prefix, such as (59a) (repeated from above), as sharply unacceptable.

- (59) a. \*ger-ð { á bílnum / bílsins / við bílinn }  
 do-NMLZ { on car.the.DAT / car.the.GEN / with car.the }  
 INTENDED: ‘repair of the car’<sup>16</sup>
- b. við-ger-ð { á bílnum / bílsins / \*við bílinn } tók langan tíma  
 with-do-NMLZ { on car.the.DAT / car.the.GEN / \*with car.the } took long time  
 ‘Repair of the car took a long time.’

This general picture makes sense from the present perspective. From a purely syntactic standpoint, prepositional prefixing is a general option in the language: P may adjoin to n (or v or a, for that matter), and create another n. However, the interpretation of this operation involves the negotiation of root meaning. To put it plainly, there has to be a reason to do it: if there is no established (or computable) root semantics depending on the relation between P and

<sup>15</sup> Sigríður Sæunn Sigurðardóttir has reported encountering examples like (57), and finds herself ‘nearly ready to accept them’. All other speakers I have asked reject this, however. Another, for present purposes irrelevant use of *um-* as a prefix is possible, where *umhugsa þetta* would mean ‘rethink this’. This use of *um-* is fairly productive, and means something like ‘do again in a different way’. Its distribution has not been studied, as far as I know, and I also do not know how widely accepted its use with *hugsa* ‘think’ is. Halldór Sigurðsson, for example, rejects this usage, although he accepts it with *umorða* ‘reword/rephrase’ and *umskrifa* ‘rewrite (in a different way)’.

<sup>16</sup> This string may be grammatical with other readings.



the root, the result will seem strange, superfluous, and even totally unacceptable.<sup>17</sup> This is essentially the same sort of issue revolving around any root-derived word. If a given root adjoins to *n*, to form a noun, the speaker and the speech community must negotiate what this root+*n* combination will mean. According to the present proposal, prepositional prefixing is a way of fixing/establishing root meaning, so it is subject to the same kinds of conditions, despite being a generally available syntactic option.<sup>18</sup>

In contrast, speakers reject the absence of prefixing when it is necessary because there, the system does not generate the appropriate form-meaning pair. Even if speakers can easily figure out what *\*gerð við þetta* ‘repair of this’ or *\*brögð við þessu* ‘reaction to this’ should mean, the forms are ungrammatical. This is because the prepositions are too far away from the root to condition the appropriate meaning, so the intended meaning is not built.

### 4.3.5 Mixed Patterns: Doubling optional

I have argued that apparent “doubling” of a preposition indicates that the preposition has two functions. First, it expresses its own meaning, which is realized by heading a PP complement. Second, it conditions special root meaning, which is realized as prefixing of *P* to the derived noun. It may seem surprising, then, that in some cases, the preposition is only optionally repeated. With *hlynnna* ‘tend’, for example, the preposition may be repeated or the relevant argument can be expressed as a genitive.

- (60) að {*\*að-*} **hlynnna** {**að**} sjúklingnum  
 to {*\*to-*}attend {to} patient.the  
 ‘to attend to the patient’
- a. *\*(að-)*hlynning **að sjúklingnum**  
*\*(to-)*tend-NMLZ to patient.the.DAT  
 ‘tending to the patient’
- b. *\*(að-)*hlynn-ing **sjúklingsins**  
*\*(to-)*tend-NMLZ patient.the.GEN  
 ‘tending to the patient’

But if the argument can be expressed as a genitive in (60b), what meaning could the preposition be contributing in (60a)?

I suggest that the answer lies in the range of meanings available to the genitive, along with the rather vague (but still meaningful) contribution of the preposition. In short, the two structures arrive at the same or at least substantially overlapping meanings in different ways. Therefore, we find apparent semantic overlap for certain nominals, but not others. First, there may be subtle semantic distinctions that are hard to pin down. Consider the pair in English:

- (61) a. tend the patient  
 b. tend to the patient

Speakers tend to report that there is some meaning difference between these two, but it is difficult to say exactly what that is.

<sup>17</sup> Thus, Anton Karl Ingason points out that adjunction is usually thought to be recursive, which might lead one to expect that prepositions can be freely added as prefixes. The claim here is that syntactically, this is true—but there would be no lexical semantic reason to add more instances of the same prefix to a head. Adding distinct prefixes would have conflicting effects, since it would be impossible to interpret a single root in two different ways. One possibility that I leave open is if two distinct prepositions are needed, together, to condition a single allomorph of the root; in this case, two prefixes would be possible in principle, assuming that the locality conditions on special meaning were not violated (and to be sure, nothing in the present proposal says that they would be).

<sup>18</sup> See, for example, the discussion of *thief* versus *stealer* in Embick & Marantz (2008). Embick & Marantz (2008) argue that the existence of *thief* does not directly block the formation of root-derived *stealer*. If there is any interaction, it may be at the level of use, not grammar: syntactically, [<sub>n</sub> √STEAL n<sub>er</sub>] is grammatical. However, speakers may have never needed to create such a root nominalization. In fact, I strongly suspect that if one surveyed a variety of English speakers (who have not studied the linguistic literature on the issue) on the acceptability of *stealer*, the range of reactions would be highly similar to the reactions described above for “unnecessary” prefixing (some rejecting, some saying ‘weird but possible’, some trying give it a special meaning). See also Embick (2016) on “polymorphy” and competition at the level of use.

It is well-known that the genitive can express a range of relations between two nouns in Icelandic (similarly to English) (H.Á. Sigurðsson, 2006; Pfaff, 2015; Harðarson, 2017, to appear). In this instance, the genitive can express a meaning that comes “close enough” to the relation expressed by the preposition as to resemble optionality.

- (62) a. **Meaning 1 (Genitive)**  
 ‘tending activities defined/measured by, or revolving around the patient’  
 b. **Meaning 2 (að PP)**  
 ‘tending activities directed toward the patient’

The situation is reminiscent of the dative alternation, where there is a meaning difference between two variants but substantial overlap in the result, resulting in well-known pairs like (63) (Green, 1974; Oerhle, 1976; Pesetsky, 1995; Harley, 2002):

- (63) a. send the letter to {them / France}  
 b. send {them / #France} the letter

If this is the right way of looking at the alternation between a genitive and a PP in cases like (60)—that is, that the two variants are semantically distinct but substantially overlapping in their meanings—then we might expect to find particular examples where the genitive has meanings that the PP cannot, and/or vice-versa. In fact, we find exactly this. First, and most sharply, consider the following contrast.

- (64) a. Fengu þeir **að-hlynn-ingu læknis** á virkjanasvæðinu.  
 got they to-tend-NMLZ doctor.GEN at power.plant.area.the  
 ‘They were tended to by a doctor at the power plant area.’  
 b. #Fengu þeir **aðhlynningu að lækni** á virkjanasvæðinu.  
 got they to-tend-NMLZ to doctor.DAT at power.plant.area.the  
 ≠ ‘They were tended to by a doctor at the power plant area.’
- (65) a. enda naut hann **að-hlynn-ingar frábærs starfsfólks** á þessum stofnunum  
 and enjoyed he to-tend-NMLZ great employees.GEN at this office  
 ‘And he enjoyed being tended to by the great employees at this office.’  
 b. #enda naut hann **aðhlynningar að frábæru starfsfólki** á þessum stofnunum  
 and enjoyed he to-tend-NMLZ to great employees at this office  
 ≠ ‘And he enjoyed being tended to by the great employees at this office.’

When *aðhlyning* is the complement of verbs like ‘get’, ‘need’, ‘receive’, ‘have’, etc., the genitive is easily and most saliently understood as referring to the one doing the tending, rather than the one receiving it. This reading is completely unavailable with the *að*-PP, which can only introduce the people being tended to. Note that this fits with the general genitive meaning suggested above, “tending activities defined/measured by, or revolving around the nursing staff/doctor/etc.”

However, there are more subtle contrasts as well, that point to a non-equivalence of the genitive and the PP. Consider the attested example in (66a), and what happens if the genitive is changed to a PP.

- (66) a. ...að mistök hefðu verið gerð við **að-hlynn-ingu hans**  
 ...that mistakes had been made with to-tend-NMLZ him.GEN  
 ‘... that mistakes had been made with his care/treatment/tending.’<sup>19</sup>  
 b. #? ...að mistök hefðu verið gerð við **að-hlynn-ingu að honum**  
 ...that mistakes had been made with to-tend-NMLZ to him  
 ‘... that mistakes had been made with tending to him.’

A scenario that is compatible with (66a) would be one where the doctors correctly administer a course of treatment, but later determine that that course was a mistake as a whole. For example, they decide on a particular surgery followed by a particular course of medication. They later decide that this course of treatment had been a mistake; they should have chosen a different kind of surgery or a different course of medication. In (66b), however, this scenario is much less

<sup>19</sup> Example from RMH.

likely. In (66b), a more appropriate scenario would be one where the overall course of treatment is not a mistake, but the doctors made a mistake in the process of administering it. For example, they chose the correct surgery, but made a mistake in performing it, or they chose the right medication, but accidentally administered something else. That is, the PP example more saliently brings out the activities directed toward the patient, whereas the genitive emphasizes the event as a whole. In most circumstances, those two readings will overlap enough that they may seem to be equivalent.

Now compare this with a case where the genitive is not possible:

- (67) **Þeir {að-}laga sig {að} breytingunum.**  
 they {to-}adapt REFL.ACC {to} changes.the.DAT  
 ‘They adapt to the changes.’
- a. að-lög-un að breytingunum  
 to-adapt-NLMZ to changes.the.DAT  
 ‘adaptation to the changes’
- b. \*að-lög-un breytinganna  
 to-adapt-NLMZ changes.the.GEN

Evidently, the meaning of the genitive is not able to construct an overlap of the sort seen above. Here, we do not have adapting activities defined, measured by, or revolving around the changes. Rather, the directional meaning is a core part of the change-of-state meaning of the verb, and must be expressed with the PP.

Finally, there are some cases of speaker variation. Recall that sometimes more than one preposition is possible to express a given idea.

- (68) a. **á-bend-ing-in á** skekkjuna  
 on-point-NMLZ-the on mistake.the.ACC  
 ‘the pointing out of the mistake’
- b. **á-bend-ing-in um** skekkjuna  
 on-point-NMLZ-the about mistake.the.ACC  
 ‘the pointing out of the mistake’

The present proposal would lead us to suspect that the prepositions are doing subtly distinct things, semantically. Interestingly, the genitive is possible here for some speakers, but not others:

- (69) % á-bend-ing skekkjunnar  
 on-point-NMLZ mistake.the.GEN

Jóhannsdóttir (1995, 71) marks (69) as ungrammatical, but Halldór Sigurðsson (p.c.) finds (68a) “awkward, but maybe just stylistically,” but not clearly better than (69). I have since found other speakers who accept or reject (69). The emergence of this kind of variation is now expected, since constraints on the use of genitive stem from rather subtle aspects of (de)verbal meaning, which can vary from speaker to speaker, an underspecified set of genitive meanings, which can vary in their salience and availability, and potentially vague/overlapping contributions of the preposition.

Despite the uncertainty and variation in some cases, there are clear patterns well. Both the patterns and the exceptions to them clarify what factors underlie doubling and its absence. They support the view that what underlies all of this is the semantic relationship between the verb root and its argument, the role that prepositions may play in mediating that relationship, and the role that prepositions may play in determining the verb root’s meaning. Ultimately, I argue that the locality of these relationships points to a Complex Head analysis of deverbal nouns rather than a Phrasal Layering analysis.<sup>20</sup>

<sup>20</sup> A related but logically distinct point is that irrespective of the actual contribution of the preposition, what is really important in the present account has to do with the relationship between the preposition and the root/verb. The question is whether we need to know the lexical identity of the root in order to determine the interpretation of the preposition. This distinguishes between allowing (or requiring) a preposition and disallowing one.

### 4.3.6 Prepositional prefixing and RNs

So far in this chapter, I have discussed in detail cases where a preposition may prefix to a derived nominal but not the verb it is based on, and the focus has been on derived nominals with arguments structure, in order to flesh out the role of prepositions in the introduction of arguments, on the one hand, and the interpretation of the root, on the other. However, prepositional prefixing also occurs as a way to derive RNs, and many cases of prefixed derived nouns may only have an RN reading. For example, consider the verb phrase *byggja við húsið*, literally ‘build with the house’, which is used to describe a situation where a house already exists, and one adds an extension to it, making it bigger. For example, one may add an extra room to the side of the house. This extension can be referred to with the nominal *við-bygg-ing*, with the preposition *við* ‘with’ prefixed to the deverbal noun *bygg-ing*; this reading is illustrated in (70b). However, this form—*viðbygging*—only has this RN reading, and not an SEN or CEN reading. Thus, (70d) below cannot have an argument reading for *á húsinu* ‘on the house’ corresponding to the verb phrase in (70a). (It can only have a locative adjunct reading, where the addition is located “on the house”.)

- (70) a. byggja við húsið  
build with house.the.ACC  
‘build an addition onto the house’
- b. Við-bygg-ing-in var ljót þegar hún var blaut.  
with-build-NMLZ-the was ugly when it was wet  
‘The addition was ugly when it was wet.’
- c. # Við-bygg-ing-in tók langan tíma.  
with-build-NMLZ-the took long time  
‘The addition took a long time.’<sup>21</sup>
- d. ?? Við-bygg-ing-in á húsinu tók langan tíma.  
with-build-NMLZ-the on house.the.DAT took long time

The following passage, retrieved from the web,<sup>22</sup> illustrates this phenomenon nicely.

- (71) **yfirbreiðsla yfir sófa**  
Ég á tvo sófa úr Ikea. Þeir eru ágætir, en áklæðið á þeim er orðið ansi sjúkað, enda með tvö lítil börn. Ég get ekki þvegið áklæðið í þvottavél, en það má fara í hreinsun (hef ekki athugað hvað það kostar). Ég get keypt nýtt áklæði í Ikea á 15.000 kr fyrir hvorn sófa en ég tými því ekki... Krakkarnir eru soddan sóðar að það tekur ekki langan tíma að klína sófana út aftur. Þess vegna spyr ég ykkur,

hvar fæ ég fallega **yfir-breið-slu yfir sófa? Yfir-breið-slu** eða bara stórt teppi [...] til að **breiða yfir sófana**, eitthvað sem ég get hent í þvottavélina og svona :)

#### covering over a sofa

I have two sofas from Ikea. They are nice, but the upholstery is getting a bit worn down, especially with two little children. I can’t wash the fabric in a washing machine, but it can be taken to a dry cleaner (have not checked what that costs). I can buy a new covering at Ikea for 15,000 krónur per sofa, but I can’t afford it. The kids are messy enough that it won’t take a long time to mess up the sofas again. For this reason I ask you,

where can I get a beautiful **over-spread-NMLZ.ACC over a sofa? Over-spread-NMLZ.ACC** or just a large blanket [...] to **spread over the couches** (=conceal or hide the couches), something that I can toss into the washing machine and such :)

<sup>21</sup> As Jóhannes Gísli Jónsson points out, *viðbygging* ‘addition’ can have a kind of event interpretation, but it is the one that can be coerced from almost any concrete noun. For example, one can say ‘The shirt took 10 minutes’ if it is understood as an event connected with the entity described by the shirt, such as folding it, sewing it, etc. This is clearly distinct from the CEN reading, and even the SEN reading. Note that this in itself may form an argument in favor of CENs as discretely distinct from other eventive readings, and not derived from general semantic coercions available to nouns; such coercions are possible, but clearly distinct.

<sup>22</sup> <https://bland.is/umraeda/yfirbreidsla-yfir-sofa/6615138/>, verified 2/6/2020.

Here, it is clear that an *yfirbreiðsla* is derived from *breiða yfir*, which is literally ‘spread over’ but has the idiosyncratic meaning ‘conceal or hide’.<sup>23</sup> This is similar to what we have seen so far, but in this case, it is an RN—an object that would normally serve as the theme of a verb phrase. Even in this use, the preposition can be doubled, as in *yfirbreiðsla yfir sófa*, but it doesn’t have to be.<sup>24</sup> Like many of the examples I have focused on in this chapter, the prefixing is not possible with the verb, only with the deverbal nominalization.

- (72) \*að yfir-breiða yfir sófana  
to over-spread over sofas.the

Similarly, *að-keyr-sla* ‘to-drive-NMLZ’ and *inn-keyr-sla* ‘in-drive-NMLZ’ both mean ‘driveway’, but cannot be used as CENs. *Að-skeyt-i* ‘to-join-NMLZ’ means ‘affix’ (in the grammatical sense), but cannot form a CEN. One can enumerate many examples of this kind.

What the robust existence of this kind of pattern suggests is that the prefix can somehow influence the interpretation of n, forcing an RN reading and preventing a CEN reading. How might this be accomplished? The present system allows us to consider two possibilities. One possibility is that the preposition conditions the alloeme of n directly, and this has an effect on the interpretations available to the root. Another possibility is that the prefix conditions the interpretation of the root directly, in a way that makes it compatible only with certain alloemes of n. Either possibility is in principle compatible with the prefix attaching to the root, the v, or the n.

However, the most natural hypothesis within the general theory developed so far is that the preposition conditions the root directly. For one thing, this is needed anyway: we already have reason to think that P and the root are in the same domain for idiosyncratic interpretation, and we know that there must be a special P-root relation available and visible to the semantics. Consider *viðbygging* ‘addition to a house’. It is not enough to say that the n of *bygging* must be a concrete entity, and this limits what *bygging* can mean. It is important that it is *við* specifically that builds the specific kind of concrete entity. That is, we would have to say that the preposition conditions one of the basic alloemes of n, and that this in turn restricts the interpretation of the root; but it is not clear how this would work, since different prefixes can condition different root meanings. And as we will see in chapter 5, if P can force the root to be interpreted as a predicate of entities, it will restrict the kinds of interpretations that are available to v and ultimately n as well. In the present system, the root does not become the predicate of an entity or event variable until it is forced to, and in the examples so far, that has been when either v or n need to combine with it semantically. But in these cases, the preposition can condition the meaning of the root, forcing it to be a predicate of entities and specifying whatever idiosyncratic characteristics it is associated with. Assuming this much, v must be semantically null—that is, unless the specific lexical idiosyncrasies can be construed as carrying over into one of the compositional mechanisms described in chapter 5.<sup>25</sup>

In sum, prepositional prefixing with RNs fits naturally into the system proposed so far. We can assume that prepositions do not condition n directly, but rather condition the root in such a way as to effect the available meanings of v and n, in this case restricting them to RN readings. However, it is unclear how this would be done in a Phrasal Layering analysis, particularly when it is acknowledged that RNs can be built on top of a verbal layer. What mechanism would prevent the preposition from taking a complement, prevent the verb from being eventive, and provide an idiosyncratic meaning, just in case an n head is introduced above the v(P) level?

#### 4.4 Prepositions as probes: An alternative phrasal layering analysis

Most of the present work is concerned with a relatively straightforward kind of Phrasal Layering account, where a standard sort of verb phrase is built, whatever its structure, and that verb phrase is nominalized. This is the kind of account that is found most widely in the literature on nominalization. However, a very different kind of phrasal layering approach has been proposed by Kayne (2008), as part of a general research program to defend the idea that nouns never take complements, and the general approach is very closely connected to the analysis of PP arguments in a way that is

<sup>23</sup> The Icelandic-English dictionary at snara.is lists *breiða yfir e-ð* ‘spread over sth’ as ‘suppress, conceal, keep silent about sth’. The Icelandic dictionary at the same site lists *breiða + yfir* with a special entry and defines it with the example *reyna að breiða yfir e-ð* ‘try to spread over sth’, which it paraphrases as *reyna að hylja e-ð* ‘try to hide sth’.

<sup>24</sup> Lilja Björk Stefánsdóttir (p.c.) prefers to use *á* ‘on’, as in *yfirbreiðsla á sófa*.

<sup>25</sup> For example, it may be that entity roots are only possible with eventive v if they denote an ‘entity in a state’, e.g. a pile is an entity in a particular state/arrangement.

relevant the phenomena discussed in this chapter. In this section, I would like to consider Kayne's approach in general, as well as how it pertains to the prepositional prefixing facts discussed in this chapter.

I will begin by discussing Kayne's general approach to nominalizations (of the CEN sort), before turning to the prepositional facts. Kayne (2008) proposes that nominalizing morphemes—the suffixes themselves—are nouns, and suggests that they may have a "light noun" meaning such as 'fact' or 'way'. Nominalizations are then assumed to be relative clauses: *the removal of the evidence* is essentially something like 'the fact of removing the evidence'.<sup>26</sup> The derivation works along the following lines.<sup>27</sup> First, assume that the verb stem *remov-* occurs as part of a VP with the object, and with an abstract PP containing the nominalizer *-al*.<sup>28</sup>

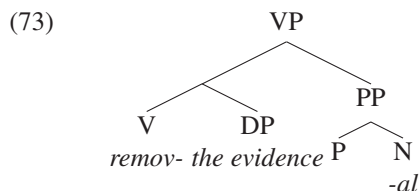

The DP object then moves to the specifier of a higher projection for Case-related reasons; I assume this to be a KP projection based on Kayne's other work along these lines.

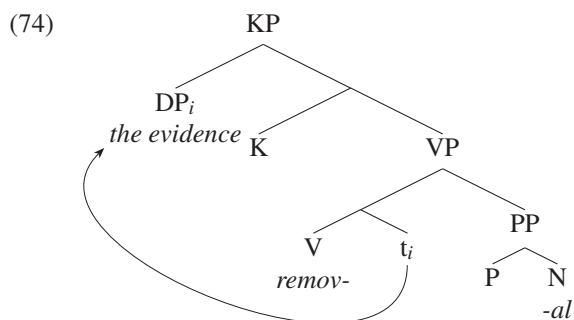

At this point, *of* merges, and the PP undergoes relativization by moving to its specifier (as in the raising analysis of relative clauses; see e.g. Bianchi 2000). I notate this as a complementizer, assuming Kayne's analysis of *of* as a complementizer (e.g. Kayne 1997), and one which may be involved in assigning or licensing Case on the specifier of its complement in ECM fashion.

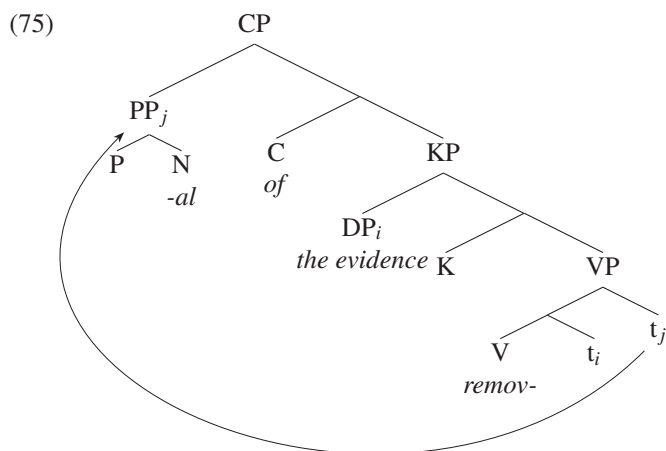

<sup>26</sup> This doesn't seem like the right paraphrase, but that is beside the point; it could equally be 'the event of removing the evidence'; an even closer paraphrase in the spirit of Kayne's proposal might be 'the event in which someone removed the evidence'.

<sup>27</sup> Kayne does not always make it clear what the underlying or derived constituent structure is, or what the labels of constituents are, so much of this information is omitted from the following trees, which reflect my best interpretation of what Kayne seems to have in mind, taking into account general principles he has proposed elsewhere, etc.

<sup>28</sup> As mentioned, the internal constituency is not clear to me, but Kayne's analogy comparing this analysis to things like *the way in which we talk* leads me to assume that the verb and the object form a constituent to the exclusion of the PP.

Finally, the VP undergoes remnant movement to the left of the rest of the structure.

(76)

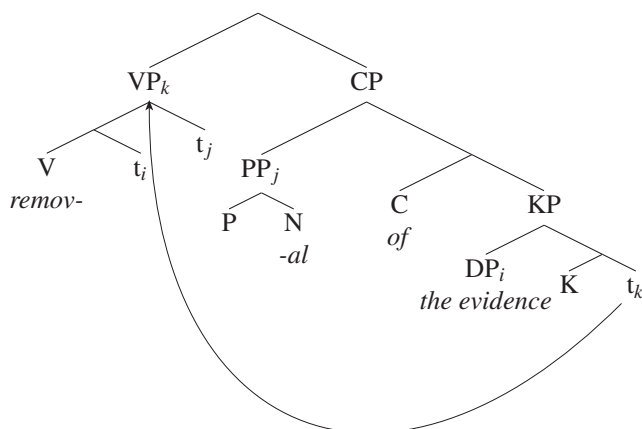

Obviously, there are many details that need to be worked out for such an analysis, and its general implications go well beyond the scope of the present work. The theoretical research program motivating it is also independent of the present work. What I would like to briefly consider, before moving on to the analysis of prepositions, is whether this kind of approach leads to different expectations about the inheritance or non-inheritance of case-marking patterns in Icelandic of the sort discussed in chapter 3. In short, I think not, but am open to the possibility that there may be a way of specifying the details of this kind of approach that would lead to different predictions.

First, consider an ordinary nominative-accusative verb, where the accusative in a verb phrase can correspond either to a genitive DP or an *á*-PP. Kayne (2008) says that the movement of the DP to (what I am calling) SpecKP is for Case-related reasons. Based on his other work, we know that this does not necessarily mean that the DP is actually assigned Case by K. In fact, it is perhaps more plausible that this movement puts the DP in a position to be assigned Case by the higher C head *of*. In Icelandic, there would have to be two possibilities for the higher *of* head: one which is silent, and assigns genitive case to the DP, and another which is overt (the preposition *á*) and assigns dative to the DP. In a non-nominalized clause, instead of one of these two C heads, there would be a head associated with accusative case. This much seems reasonable, at least within the basic framework of assumptions presently under consideration.<sup>29</sup>

Next, however, consider a verb that takes a dative direct object. Where should we assume that dative is assigned, in a framework like this? Everything we know about Icelandic suggests that it should be assigned low. Ultimately, we need to remember that the ability to assign dative, however systematic, may ultimately vary from one specific verb to the next; we need to know the identity of the verb, at some level.<sup>30</sup> It could be the verb itself, which would assign dative to the DP complement in the earliest step in (73). It could be the first K head that merges with the verb phrase, since this allows a selectional relationship with the verb; K<sub>DAT</sub> could select some verbs and not others (see e.g. Kayne's 2005b, 329 analysis of the relationship between *look* and *at*).

We would not expect, however, that it would be done at the same high level accusative case is assigned, by a dative-version of whatever it is that merges above KP to assign accusative case. Dative is fixed lower; it does not alternate the way accusative does, and it is verb-dependent in a way that accusative is not. Moreover, we would not expect a higher, ECM-like Case relation to overwrite the dative case that is determined lower. In uncontroversial ECM constructions, where a verb normally assigns structural accusative to the DP in the specifier of the complement TP, dative case is retained, not overwritten. We would expect the same here, with the result that we would get dative whether the *á* preposition is merged or not. We have seen that this is not the case.

In fact, the approach would make an interesting prediction for verbs like *afla* 'procure', which take a genitive object. Consider the examples in (77), repeated from (36) in chapter 3 earlier.

- (77) a. Við öfluðum upplýsinga.  
we procured information.GEN  
'We procured information.'

<sup>29</sup> It should be noted, though, that there is not really any independent evidence for a complementizer-like status of *á* or of genitive case assignment as there is for *of* in English (see Kayne 1997 for initial arguments in favor of this view for English). These concerns mirror the ones discussed in chapter 3, especially with the *á* PPs, so I will not repeat them here.

<sup>30</sup> For example, I assume a dative assigning v head, which is compatible with some but not all roots, which is actually analogous to Kayne's (2006) approach to grammatical gender selection.

- b. öfl-un            upplýsinga  
 procure-NMLZ information.GEN  
 ‘procurement of information’
- c. öfl-un            á { upplýsingum / \*upplýsinga }  
 procure-NMLZ on { information.DAT / \*information.GEN }  
 ‘procurement of information’

The pattern we see is the one we have seen all along: no sign of case inheritance. The nominalization in (77b) can take the object in genitive, because nominalizations generally can, or it can take the object as an *á*-PP, where *á* assigns dative, because this is the general pattern for nominalizations, irrespective of the case pattern found in the vPs normally projected by the underlying verbs. Genitive in the verb phrase is like dative; it is preserved under A-movement, and it is unaffected by ECM configurations. In the proposal under consideration, we would actually expect genitive, and not dative, to appear with *á* in (77c). Genitive would be assigned low, by the verb or by K, and would not be changed, even if a higher Case assigner such as *á* Case-licensed it in an ECM configuration. That is, in this approach, we expect case inheritance for all nominalizations, whether *á* is present or not.

Finally, even if a proposal were devised to get around these issues, it would still have to deal with the facts in Lithuanian described in section 3.1.6. There we saw that Lithuanian does have independent evidence for a Phrasal Layering analysis of nominalizations, and, as predicted, those nominalizations do inherit the case patterns of the corresponding verb phrase. Thus, a Kayne-style Phrasal Layering should be made to allow for preservation of verb phrase case patterns. But once this is done, we expect such patterns to be inherited in Icelandic as well.

As an interim summary, a Kayne-style Phrasal Layering analysis does not offer any obvious solution to the problems connected with case patterns that Phrasal Layering analyses face in general. The caveat is that there are many details that are left open in Kayne’s analysis, and it is always possible that there is some way of filling them in that derives the Icelandic facts, and moreover provides a way to simultaneously understand how Icelandic differs from Lithuanian. But this remains to be done; there is no straightforward solution that follows directly from existing proposals. The present proposal offers a fairly clear analysis of why Icelandic does not inherit verb phrase case patterns, while Lithuanian does: Icelandic nominalizations are not built on verb phrases, and Lithuanian nominalizations are.

With this much established, I now turn to the analysis of prepositional arguments within this framework, since once again, it raises some interesting issues and possibilities that may be worth considering in future work. So far in this work, I have adopted the more or less mainstream assumption that prepositions form constituents with DPs underlyingly, inside the vP. However, it is worth also considering how Kayne’s analysis of prepositions in Kayne (2004, 2005b) (see also Michelioudakis & Angelopoulos 2019) might bear on the patterns discussed in this chapter. The way that Kayne conceives of this kind of derivation involves the P element (here *at*) selecting the verb (phrase), rather than the other way round (see Kayne 2005a). I will again argue here that this analysis runs into problems, but they are somewhat different in nature from what has been discussed so far, and are therefore worth considering independently.

Consider first how a verb phrase like *gera við bílinn* ‘repair the car’ (lit. ‘do with the car’) would be derived. The VP *gera bílinn* ‘do the car’ would be selected by the preposition *við* ‘with’, which I take to be an instance of the K head discussed above, and this preposition would attract the DP to its specifier for case licensing.

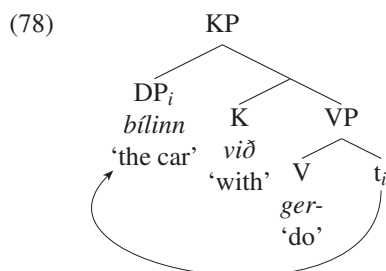

A higher functional head then merges, and the K head moves to that head while the VP moves to the left of that head. For reasons that will be clear below, I will consider this higher head to be an abstract P(repositional) head.



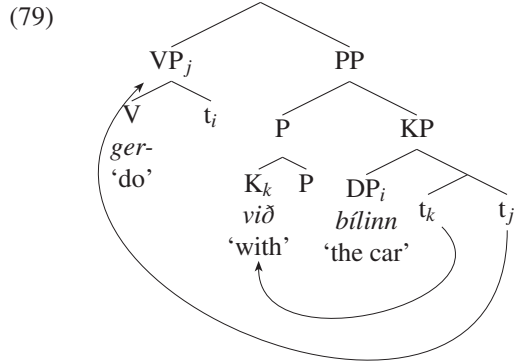

Now consider how the nominalization would work, starting with Pattern 2 (prefixing P without repeating it). The nominalizing head, which is, for Kayne, a noun complement of a silent P, would be in the structure. Let us assume that everything happens in the same way up to KP, but that in this case, the higher abstract P head does not merge, so the K head and VP do not move to it.

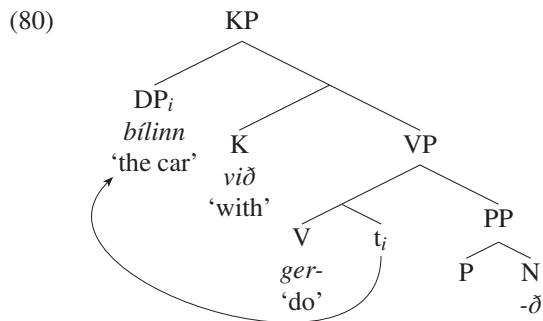

The C head, which is realized as the preposition *á* or as genitive case on the embedded DP, merges and attracts the PP nominalizer phrase to its specifier for relativization.

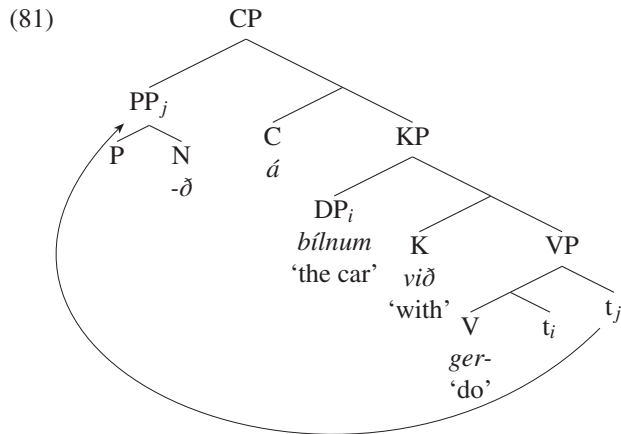

At this point, following the derivation above, the VP is supposed to move to the left of the whole structure. That would incorrectly place the P/K head *við* 'with' at the end of the phrase. To get the morpheme order right, we might assume that P/K moves with the VP in this case.<sup>31</sup>

<sup>31</sup> One might object to the movement of an intermediate projection, so we could suppose that the DP in the specifier moves out first, so the whole KP moves. Recall that Kayne is not entirely clear on the labeling and constituency in his derivations, so this objection might have more to do with my interpretation of his proposal than the proposal itself.

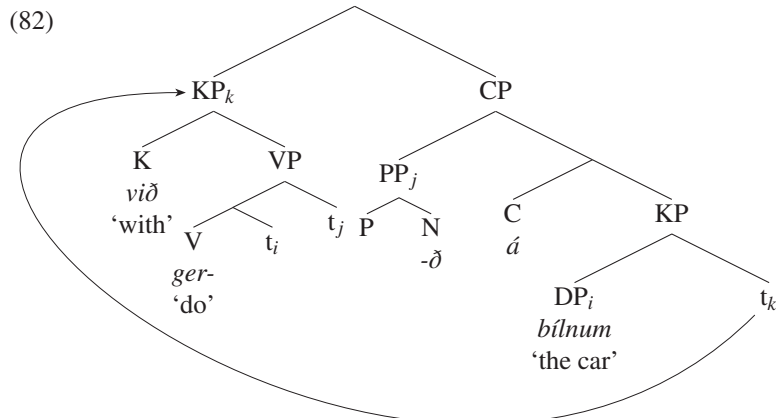

It is in fact striking that there is a stage in the derivation where the P/K head immediately precedes the verb, just as we need it to, and it is in fact this observation that led me to consider how Kayne’s analysis relates to the Icelandic facts in the first place.

The derivation above is aimed at capturing the Pattern 2 cases. For reasons of space, I will show the derivations of Patterns 3 and 1 stepwise, without the full tree structures, but the reader can presumably work out what the trees would look like. For Pattern 3, where the preposition is not prefixed, we could assume that the higher P head is merged after all, and that in fact, the overt preposition that we see is is a realization of this head. The P head moves to C, so the C head is not realized in its usual way as *á* or genitive case. The K head could be assumed (for simplicity) to move as before, but we do not see it because it is silent.

(83) Pattern 3 Derivation

- a. [VP think this P N<sub>ing</sub> ] → merge K, move DP to SpecKP
- b. [KP this<sub>i</sub> K [VP think t<sub>i</sub> P N<sub>ing</sub> ]] → merge P
- c. [PP P<sub>about</sub> [KP this<sub>i</sub> K [VP think t<sub>i</sub> P N<sub>ing</sub> ]]] → merge C, move P to C, PP to SpecCP
- d. [CP [PP P N<sub>ing</sub> ]<sub>l</sub> P<sub>about<sub>k</sub></sub>+C [PP t<sub>k</sub> [KP this<sub>i</sub> K [VP think t<sub>i</sub> t<sub>i</sub> ]]]] → Move K+VP
- e. [[KP K [VP think t<sub>i</sub> t<sub>i</sub> ]]<sub>m</sub> [CP [PP P N<sub>ing</sub> ]<sub>l</sub> P<sub>about<sub>k</sub></sub>+C [PP t<sub>k</sub> [KP this<sub>i</sub> t<sub>m</sub> ]]]]

For Pattern 1, where the preposition is prefixed *and* repeated, we could assume that the prefix is a realization of the K head, while the “repeated” version is the higher P head, which moves to C. After all, my own proposal is that cases of apparent doubling are really distinct instances of the same preposition, and I have shown that distinct prepositions can be used. The same analysis can be applied here, albeit in a very different way.

(84) Pattern 1 Derivation

- a. [VP point error P N<sub>ing</sub> ] → merge K, move DP to SpecKP
- b. [KP error<sub>i</sub> K<sub>on</sub> [VP point t<sub>i</sub> P N<sub>ing</sub> ]] → merge P
- c. [PP P<sub>on</sub> [KP error<sub>i</sub> K<sub>on</sub> [VP point t<sub>i</sub> P N<sub>ing</sub> ]]] → merge C, move P to C, PP to SpecCP
- d. [CP [PP P N<sub>ing</sub> ]<sub>l</sub> P<sub>on<sub>k</sub></sub>+C [PP t<sub>k</sub> [KP error<sub>i</sub> K<sub>on</sub> [VP point t<sub>i</sub> t<sub>i</sub> ]]]] → Move K+VP
- e. [[KP K<sub>on</sub> [VP point t<sub>i</sub> t<sub>i</sub> ]]<sub>m</sub> [CP [PP P N<sub>ing</sub> ]<sub>l</sub> P<sub>on<sub>k</sub></sub>+C [PP t<sub>k</sub> [KP error<sub>i</sub> t<sub>m</sub> ]]]]

The advantage to this kind of analysis over the other, more standard phrasal layering analysis is that it could be connected with the issues of semantic compositionality that I have identified in this chapter. The lower preposition, identified here as the K head, selects the verb phrase directly. It would be the “idiosyncratic” one, which interacts directly with the verb root. The higher preposition, identified here as the P head, would be the compositional one. Since the lower K position and the verb depend on each other for meaning, one could argue that this semantic dependency is akin to idiom formation. It is well known that there are many cases in which idioms cannot be broken up by movement. Prefixing is necessary because if VP is to move, K must move with it; otherwise the idiomatic meaning is lost.

This kind of analysis is very different from the more widely assumed kind of Phrasal Layering analysis, so it is worth considering on independent grounds. Unlike the standard Phrasal Layering analysis, here there is a possible way of making sense of the prefixing patterns and their connection to lexical semantics. However, it faces some problems of its own, some of which I will briefly discuss here. First, it is built on the general analysis of nominalizations, whose

problems with case assignment patterns were discussed earlier. Second, it is not clear how to pair these structures with the semantics. The higher P needs to be the semantically compositional one, but its position renders it rather far from the DP argument it applies to, so it is not clear that ordinary function/argument semantics will work. In short, the semantic interpretation does not seem to be reflected in the syntactic constituency.<sup>32</sup> Third, while this analysis depends on the idea that there are two positions for prepositions, a low, non-compositional position and a higher, compositional position, there is in fact no independent evidence for this that I know of.<sup>33</sup> Fourth, the explanatory force of the proposal depends on the idea that the K head and the VP cannot be separated by movement of the latter away from the former. But this only seems to hold when the structure is nominalized; in ordinary verb phrases, without prefixing, the VP must move away from the K head precisely in order to *prevent* it from becoming a prefix in those cases (see (79)). So the assumption that K+VP cannot be broken up seems difficult to maintain. Fifth, there are other differences between nominalized structures and non-nominalized structures that need to be accounted for. When the higher P merges, it triggers both K-to-P head-movement and movement of VP to SpecPP—but only in non-nominalized structures. What prevents this only when, later in the derivation, the nominalizing CP structure will be merged? Sixth, when we step back from nominalizations, it is not clear what to make of Pattern 1 verbs in non-nominalized verbal contexts. In (84), the same preposition is merged twice, once as a K head to condition special meaning, and once as a P head for compositional meaning. But in verb phrases it seems that only one preposition is present, and it does both things. Perhaps in the absence of nominalization, since the K head has to move to P, only one of them can be pronounced. But the mechanism to make sure that the same preposition occurs in both positions, is interpreted differently in each but pronounced as one, is entirely unclear. Finally, there are still very many details of this kind of analysis in general that remain to be worked out. The nature of the movements involved, the underlying and derived constituencies, the labels of the constituents, the position and role of the external argument, the mechanisms responsible for morphological case, the locality conditions for allomorphy, and various other issues have not yet been adequately sorted out.

For these reasons, I do not believe that this alternative kind of Phrasal Layering analysis is a viable alternative to the proposal developed in this book at this time. However, since the overall approach is so different from the other Phrasal Layering analyses, and since independent development of this approach could change the argumentation here, I leave it as an open possibility that some version of this kind of analysis could be made to work. As mentioned above, I find it striking that in this kind of analysis, prepositions essentially start out as prefixes and are separated as part of the normal course of the derivation. This alone suggests the possibility that what is really going on with prefixing not a special instance of attaching P to a verb, but rather the special absence of a process that breaks them up. In this section I have fleshed out what that might look like, however, and have concluded that it raises more problems than it solves.

## 4.5 Conclusion

This chapter has focused on how Icelandic prepositional prefixing supports three main points. First, prepositions play a dual role in constructing verb meaning. Second, the patterns of prefixation support the complex head theory of deverbal nouns argued for in this book. Third, we should distinguish adjunction from complementation for the purposes of locality.

As for the first point, specific cases can be hard to distinguish in practice, but there is a clear sense that prepositions (i) may or may not have meaning of their own, and (ii) may or may not condition special meaning on the verb root. We have seen how these distinctions come out in the denominal prefixing patterns. In deverbal nouns, prefixing is connected to special verb meaning, whereas heading a PP is connected with independent P meaning.

This brings us to the second point. The range of patterns in denominal prefixing would be hard to understand if deverbal nominals were built on top of verb phrases. The locality between the root and the preposition would be the same in all cases.

<sup>32</sup> See, however, Pesetsky (1995) and H.Á. Sigurðsson (2012b) for possible ways to approach the interpretation of this kind of constituency.

<sup>33</sup> And in general, PPs have a very different distribution from DPs in Icelandic, and that difference is not reflected in the version of Kayne's analysis that I have worked out here.

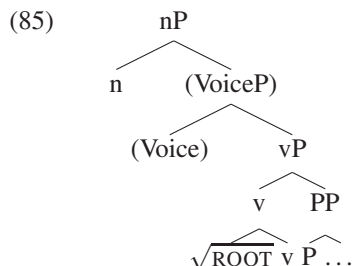

When prefixing occurs only on nouns, a movement account would require skipping the verb (possibly violating the HMC), or moving to the verb only when the verb moves further. Even with such stipulations, such movement should not have any effect on the meaning, which seems contrary to fact. Finally, it is not clear why such movement would sometimes but not always involve doubling—again in a way that is connected to meaning.<sup>34</sup> In contrast, the complex head analysis explains why such patterns arise in the first place, and how they connect to lexical semantics.

Finally, if we accept that prefixing really is to the noun, and not the verb, it is clear that we have to distinguish that structure from the complementation structure. The general intuition pursued here is that complex head formation allows P to attach to a noun without the n head intervening between it and the root. It seems that the relation between terminals within a complex head is closer than the relation of those terminals to the complement—but the complement must be visible at least sometimes (e.g. when there is only one category-determining head). I suggest that this may give us a handle on synthetic compounds of idioms like *blow the whistle*, *whistle-blowers*, *??blowers of whistles*, or *break the ice*, *ice-breaker*, *\*breaker of ice*. If we form synthetic compounds by adjoining the nonhead to the head n directly, it may allow the nonhead and the root to see each other in a way that it not possible in the phrasal counterpart.

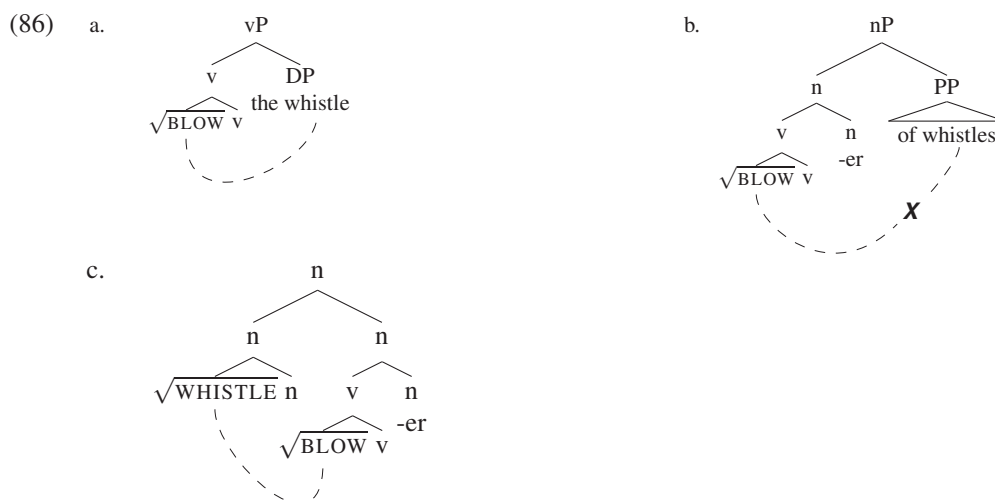

This latter point underscores the point that even when we are not building words on top of phrases, we are still doing it in the syntax, with systematic syntactic principles, which cut across the classic word/phrase distinction.

<sup>34</sup> Such movement could, however, be expected to have focus-like effects, like what is found with verb doubling in predicate clefts, as pointed out to me by Enoch Aboh (p.c.). But the kind of lexical semantic effects that we find would not be expected.

## Chapter 5

# Complex Event Nominals and Inheritance

In this chapter and the next, I present the details of the structural analysis defended in the previous chapters. Drawing in particular on the notion of allosemy, I show how one structure can get multiple readings, accounting for both (partial) inheritance of argument structure on the one hand, and the systematic ambiguity of derived nominals on the other. After briefly introducing how allosemy derives the basic, well-known readings of deverbal nominalizations, this chapter focuses primarily on Complex Event Nominals, where argument structure seems to be inherited. The claim here is that this reading arises when *v* gets the normal meaning that it gets in the context of a verb phrase, and *n* is semantically zero (an identity function). If the preposition *á* heads a PP complement of *n*, it can also be semantically zero. The result is, semantically, as though *v* combines directly with the DP.

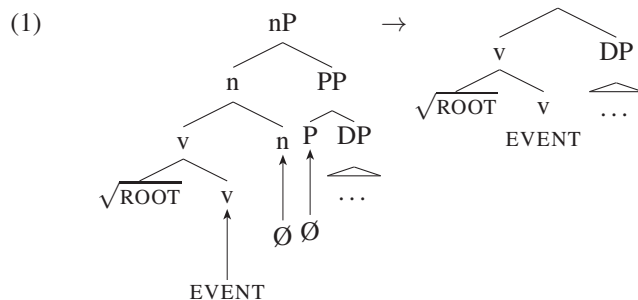

Thus, the nP is semantically like a vP, and so it seems to inherit argument structure from a vP—at least as far as the internal argument is concerned. However, all *n* really inherits is the meaning of the verb. Above the nP level, similarities between the verb phrase and noun phrase stem from parallel interpretive principles, not direct inheritance.

### 5.1 The interpretation of nominals, simple version

In this section, I present a simplified version of the basic idea, showing how allosemy derives the basic readings of derived nominals. What I would like to emphasize first, however, is that the proposal I would like to make is independent of the specific semantic formulas I use to execute it. The point of presenting a specific set of denotations in lambda formulas is to show exactly how a theory of allosemy like the one I am proposing works in its details. What is presented in this book, however, is primarily a theory of the interface between syntax and semantics, not a theory of the semantic representations themselves. If the semantics of the verb turn out to be different from what I propose, this would not necessarily challenge the primary thrust of the proposal. If, however, the semantics of the deverbal nominal in a CEN reading turned out to be discretely distinct from the semantics of the verb it is derived from, this would challenge the present proposal.<sup>1</sup> It seems to me to be possible, for example, to incorporate Discourse Representation Theoretic semantics along the lines proposed by Roßdeutscher & Kamp (2010) and Pross (2019),

<sup>1</sup> Note that verbs may have meanings that do not show up in the derived nominal. What I am claiming is that the meaning of the derived nominal, in a CEN reading, will correspond to a possible meaning of a verb. To put it bluntly, the claim is that if a telicity PP is possible with a nominal, then there will be a morphologically related verb that same meaning.

although the specifics of those proposals would have to be modified because they are built on a Phrasal Layering analysis of the syntax, which is at odds with the proposal here.

In part for this reason, I present two versions of the analysis. The first one uses a relatively simple denotation of the verb, which says that the root is a predicate of events and some entity bears the theme relation to the event. The second involves no theme relation, but builds verb phrase meaning through somewhat simpler alloemes and more complex semantic rules for interpreting syntactic structure. I generally assume that the second approach is on the right track, and assume it for the remainder of this chapter and the next, but I wish to emphasize that that is a distinct issue from the primary issue in this chapter. Therefore, I would like to reiterate what the main, substantive claims I am making are, and distinguish them from the specifics of what follows. The most important claims are:

- The CEN reading is distinct from other eventive readings.<sup>2</sup>
- The CEN reading arises when *n* is semantically zero, and *v* gets its ordinary verbal interpretation.
- Because *v* gets an interpretation, CEN readings cannot involve idiosyncratic meaning relationships between the root and *n*.
- The CEN reading can be built on top of a plain verb, with no complement; that is, a *vP* is not required.
- The external argument readings of CENs are computed in parallel, built on the *nP*, not inherited from the verb.

The exact formulas in the denotations of verbs could change completely, and if they met these conditions, would still be compatible with the primary proposal made here.

### 5.1.1 A first approximation of the three basic readings

With this background in place, consider again the three traditionally recognized readings of a derived nominal, illustrated here with the noun *examination*.

- (2) a. The detective's **examination** of the evidence took a long time. (CEN)  
 b. The **examination** took a long time. (SEN)  
 c. The **examination** was on the table. (RN)

Suppose that these three readings of 'collection' are characterized by something like the formulas in (3).<sup>3</sup>

- (3) a. Complex Event Nominal =  $\lambda x \lambda e. \text{exam}(e) \ \& \ \text{theme}(x)(e)$   
 b. Simple Event Nominal =  $\lambda x \exists e. \text{exam}(x) \ \& \ x = e$   
 c. Referring Nominal =  $\lambda x. \text{exam}(x)$

The complex event nominal has the same meaning the verb would have, expressing an event of examining and a set of entities bearing the theme relation to that event. The referring nominal, in this case, denotes the entity picked out by the notion of 'exam', the simple event nominal denotes an event that is picked out by the notion of 'exam'.

The present proposal is to derive these three readings with alloemy of functional heads, such as the following.<sup>4</sup>

- (4) a.  $\llbracket v \rrbracket \leftrightarrow \lambda P_{(s,t)} \lambda x \lambda e. P(e) \ \& \ \text{theme}(x)(e)$   
 b.  $\llbracket v \rrbracket \leftrightarrow \emptyset$  (=  $\lambda x_{\tau}. x$ , where  $\tau$  is any type)  
 c.  $\llbracket n \rrbracket \leftrightarrow \lambda P_{(e,t)} \lambda x \exists e. P(x) \ \& \ x = e$   
 d.  $\llbracket n \rrbracket \leftrightarrow \lambda P_{(e,t)} \lambda x. P(x)$   
 e.  $\llbracket n \rrbracket \leftrightarrow \emptyset$  (=  $\lambda x_{\tau}. x$ , where  $\tau$  is any type)

Given these options, we could generate a number of interpretations for the same structure, depending on which alloemes of *v* and *n* are chosen. I will illustrate this with the English nominal *examination*, with the structure in (5).

<sup>2</sup> I maintain this although the diagnostics are not always perfect. The most effective diagnostic, which doesn't seem to be counter-exemplified even in Lieber (2017), seems to be telicity PPs. See section 2.3 for further discussion of the diagnostics.

<sup>3</sup> See section 1.3.2.2 for a discussion of the semantic types I am assuming, along with the identity relation " $x = e$ ".

<sup>4</sup> The following is not meant to be exhaustive; other alloemes are possible. See especially the discussion in section 6.3.

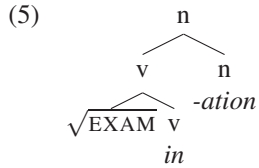

Beginning with the SEN reading, the v is semantically zero and the n is the alloseme in (4c).

(6) **Simple event** (“The examination took a long time”)

a.  $\llbracket v \rrbracket \leftrightarrow -\emptyset (= \lambda x_{\tau}. x)$  (4b)

b.  $\llbracket n \rrbracket \leftrightarrow \lambda P_{\langle e,t \rangle} \lambda x \exists e. P(x) \ \& \ x = e$  (4c)

In the semantics, these denotations are inserted into the v and n nodes (7).

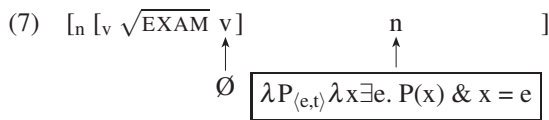

If we assume that the choice of the zero alloseme for v leads to pruning (see section 1.3.2.1), pruning of the v node will occur (indicated with strikethrough in (8)).

(8)  $\llbracket n \ \overline{\text{v}} \ \sqrt{\text{EXAM}} \ \overline{\text{v}} \rrbracket \lambda P_{\langle e,t \rangle} \lambda x \exists e. P(x) \ \& \ x = e$

Since the root  $\sqrt{\text{EXAM}}$  is semantically adjacent to the denotation inserted into the n head, it undergoes the root interpretation rule discussed in section 1.3.2.4, repeated here in (9).

(9)  $\sqrt{\text{ROOT}} \rightarrow \lambda f_f. \text{root}(f)$

In the present case, this has the result in (10), making the root into a semantic object of type  $\langle e,t \rangle$ .

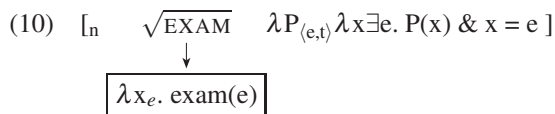

These formulas are then combined, in this case by Functional Application, to yield the result in (11).

(11)  $\lambda x \exists e. \text{exam}(x) \ \& \ x = e$

I have shown the process of interpreting the complex n head step-by-step to make it clear how each mechanism feeds the next, especially with respect to pruning (if we assume pruning), and, most importantly, the conversion of the root into lambda formula. The whole process can be represented more compactly in tree form, as in (12).

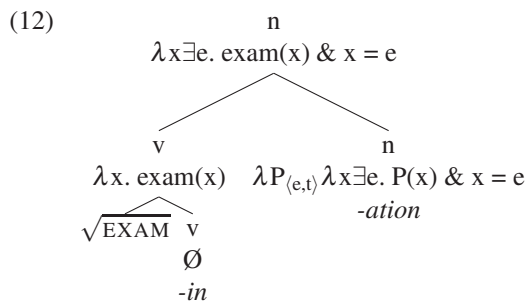

In what follows, I will generally use this tree notation, but it is important to keep in mind that the conversion of the root into a lambda formula follows the insertion of allosemes into the function heads.

Simple Entity RN readings are essentially built in the same way as SEN reading, except that the n head does not pick out an event.

(13) **Referring Nominal** (“The examination is on a table in the other room”)

a.  $\llbracket v \rrbracket \leftrightarrow -\emptyset (= \lambda x_{\tau}. x)$  (4b)

b.  $\llbracket n \rrbracket \leftrightarrow \lambda P_{(e,t)} \lambda x. P(x)$  (4d)

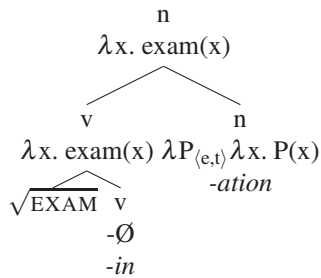

In the next chapter (chapter 6), I will present a detailed discussion of various kinds of RN readings, including true result readings that can be built off of the eventive meaning of the verb, as well as a detailed discussion of whether more semantic information is needed in the alloeme inserted into the n node, such as the whether the entity is made of concrete material or not. These are set aside for now since the primary focus of this chapter is the CEN reading, and the important point is that these other readings can be derived from the same syntactic structure as the structure used to derive the CEN reading.

Finally, in the CEN reading, things go the other way. It is the n head that gets a semantically  $\emptyset$  denotation, and the v head gets the normal interpretation it would get in the context of a verb phrase.

(14) **Complex event** (“The detective’s examination of the evidence”)

a.  $\llbracket v \rrbracket \leftrightarrow \lambda P_{(s,t)} \lambda x \lambda e. P(e) \ \& \ \text{theme}(x)(e)$  (4a)

b.  $\llbracket n \rrbracket \leftrightarrow -\emptyset (= \lambda x_{\tau}. x)$  (4e)

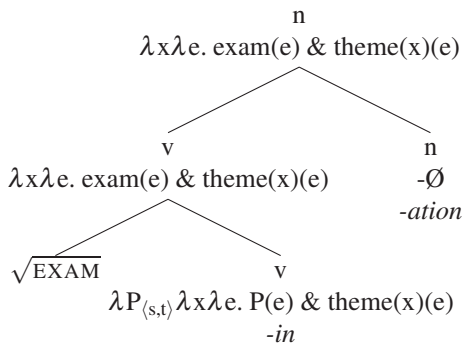

In the CEN derivation, the noun has the same meaning as the verb. When n is semantically null, some argument will have to merge to saturate the internal argument variable, just as it would with the verb. If we assume pruning, the n node is deleted and the result is semantically just as if a verb combined directly with the complement of the n head. Since the syntax is nominal, however, the set of available of complements is restricted to the kinds of complements that nouns can take—a DP or PP, for example, but not a small clause or a TP. In the next section, I discuss the internal argument in more detail.

### 5.1.2 The internal argument of complex event nominals

According to the present proposal, the CEN reading is built when the v head gets its ordinary interpretation, and the n head is interpreted as  $\emptyset$  (a type-neutral identity function). This means that the noun has the same interpretation as the verb, so if a theme needs to be expressed, it must be expressed by some constituent of the noun. Assuming that the verb has an entity variable corresponding to the theme, it will be unsaturated. It can be saturated by a complement PP or genitive DP.



(15) a. söfn-un-in á sýnum  
 collect-NMLZ-the on samples.DAT  
 ‘the collection of samples’

b. söfn-un sýna  
 collect-NMLZ samples.GEN  
 ‘the collection of samples’

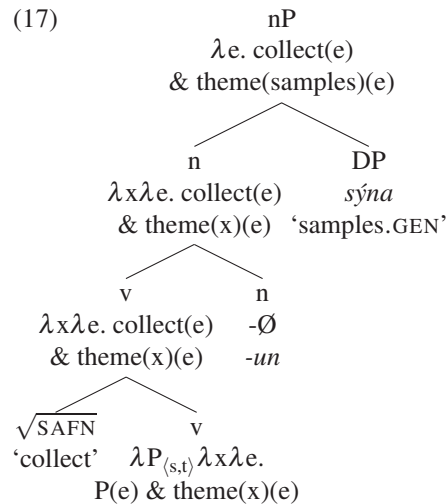
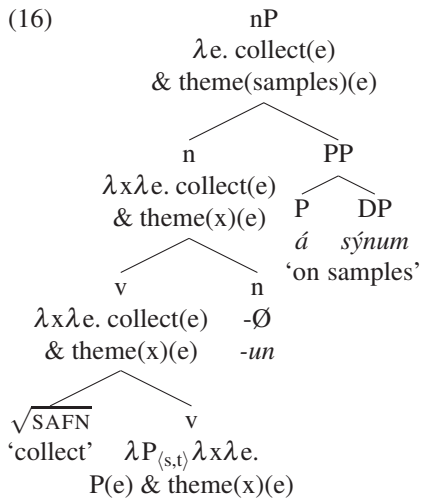

In the case of (17), the *n* head takes a genitive DP complement, which is something that we know that nouns can do in Icelandic (see (63) in chapter 3). In the case of (16), the noun takes a PP complement, which again is something that we know independently that nouns can do. The only thing extra we have to say is why the preposition *á* is chosen to realize the theme. Recall from chapter 3 that this is not a general ‘dummy’ preposition in the language. The answer provided here is not a deep one, and arguably should not be. Instead, we appeal to contextual allosemy to stipulate that in the context of an noun, *á* may be interpreted as semantically null.

(18)  $[[P_{\acute{a}}]] \leftrightarrow -\emptyset (= \lambda x_{\tau}. x) / [{}_{nP} n \_ \dots ]$

This allows *á* to be treated like a dummy preposition, but only in particular, specified contexts, such as that of a noun.<sup>5</sup> The result is that either of the two syntactic structures above allow the denotation of the DP to combine directly with the denotation of the *n*, which in turn is the same as the verb. Thus there are two syntactic means to the same semantic end, both recreating the semantic object that is created when the verb itself takes a DP theme complement.

Notice that if the theme is not merged as a DP or PP complement, the next DP argument, wherever it comes in syntactically, must be the theme. Poss, for example, cannot introduce an agent relation when the theme variable is still open. Thus, if synthetic compounds like *sample-collection* have a structure like (19), the nonhead will necessarily be interpreted as the theme as well.

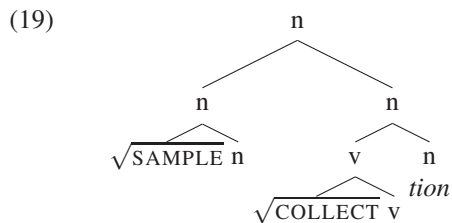

More needs to be said about compounds, however, so I will set this aside until I have discussed the interpretation of the external argument, and return to this matter in section 5.2.4.

<sup>5</sup> One could add further syntactic and semantic specifications to constrain the use of this alloseme, but I set them aside for now. Of course, this alloseme will only be useable if the noun in question is the sort that can combine with the denotation of a DP semantically.

### 5.1.3 The external argument of complex event nominals

What about the external argument? Is there any room in the structure for a Voice head? Here, I assume with Alexiadou (2001, 2017a) that even if Voice is present in a nominalization, the external argument is not introduced by it, syntactically or semantically. Moreover, I will assume, as discussed in chapter 3, that there is in fact no Voice head in the structure. In the present analysis, as I previewed in chapter 1, the agent can be introduced by the Poss head directly. This is shown in (20).

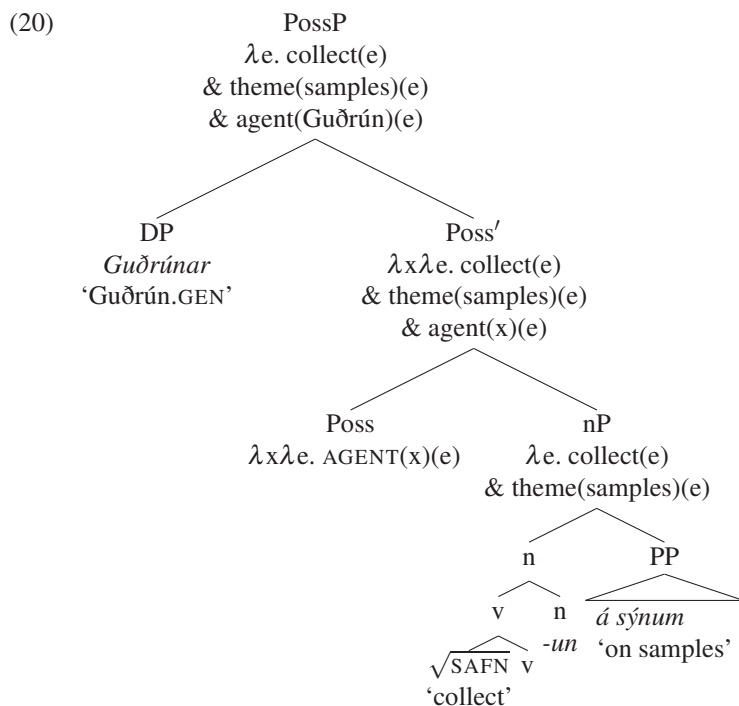

Previous work has proposed that in verb phrases, Voice is interpreted as introducing an agent whenever it combines with an agentive vP (Wood, 2012, 2015, 2016; Myler, 2014, 2016; Kastner, 2016, 2017; Wood & Marantz, 2017).<sup>6</sup>

$$(21) \quad \llbracket \text{Voice} \rrbracket \leftrightarrow \lambda x \lambda e. \text{agent}(x)(e) / \_ \text{ (agentive vP)}$$

Here, I would make a parallel proposal: Poss is interpreted as agentive when it combines with an agentive nP.<sup>7</sup>

$$(22) \quad \llbracket \text{Poss} \rrbracket \leftrightarrow \lambda x \lambda e. \text{agent}(x)(e) / \_ \text{ (agentive nP)}$$

However, notice that the context here specifies syntactic information (the category of vP or nP) and semantic interpretation (agentive meaning). Moreover, the syntactic information is predictable and redundant: Poss doesn't combine with vPs, and Voice doesn't combine with nPs. Therefore, we might make the context the same for both cases:

$$(23) \quad \llbracket \{ \text{Voice/Poss} \} \rrbracket \leftrightarrow \lambda x \lambda e. \text{agent}(x)(e) / \_ \text{ (agentive event)}$$

However, even this seems too redundant: the distribution of Voice and Poss is predictable as well. Myler (2016) and Wood & Marantz (2017) propose that Voice and Poss are really the same head, which Wood & Marantz (2017) call  $i^*$ , in two different places. In a sense, then, the external argument really is a possessor, structurally, even if it can be truly an agent in the same way that verbal external arguments are agents. The general rule is just that  $i^*$  is interpreted as an agent in the context of an agentive event.

$$(24) \quad \llbracket i^* \rrbracket \leftrightarrow \lambda x \lambda e. \text{agent}(x)(e) / \_ \text{ (agentive event)}$$

<sup>6</sup> See Kastner (2016, 2017, 2019a,b) for more contexts that can condition an agentive interpretation of Voice.

<sup>7</sup> See Myler (2016, 52) for another example of alloosemy with a Poss head.

This applies when  $i^*$  combines with nP or vP. It also allows for  $i^*$  to get other, more general possessive readings in addition to the verb-like agent meaning.

$$(25) \quad \llbracket i^* \rrbracket \leftrightarrow \lambda P_{\langle e,t \rangle} \lambda y. \lambda x. P(x) \ \& \ \text{possessor}(x)(y) / \text{ \_\_ entity (of type } \langle e,t \rangle \text{)}$$

At present, these two rules are in competition as far as contextual allosemy is concerned, but the denotation in (25) will not be useable if the nP has the meaning of an agentive event, since it would be a type clash.<sup>8</sup>

Consider the fact that in English *-ing* gerunds like (26a), the possessor can only be understood as agent, the one who is doing the performing. I assume that this is because *-ing* gerunds are built on a full verb phrase, possibly containing a Voice head (i.e.,  $i^*$  with a vP complement). In contrast, although the nominalization *performance* as in (26b) can have this reading, it can also refer to other things, like the performance that Guðrún attended, the one she is always talking about, etc.<sup>9</sup>

- (26) a. Guðrún's performing the song  
b. Guðrún's performance of the song

However, it is not clear that these other readings are really being built on the CEN reading of the noun. Notice that if one adds a telic PP, as in (27), all these other readings disappear.

- (27) Guðrún's performance of the song in two minutes

Like (26a), (27) can only refer to an event where Guðrún is the agent, the one performing. This suggests that in fact, the other readings of the possessor in (26b) are built on SEN or RN readings of the nP.<sup>10</sup>

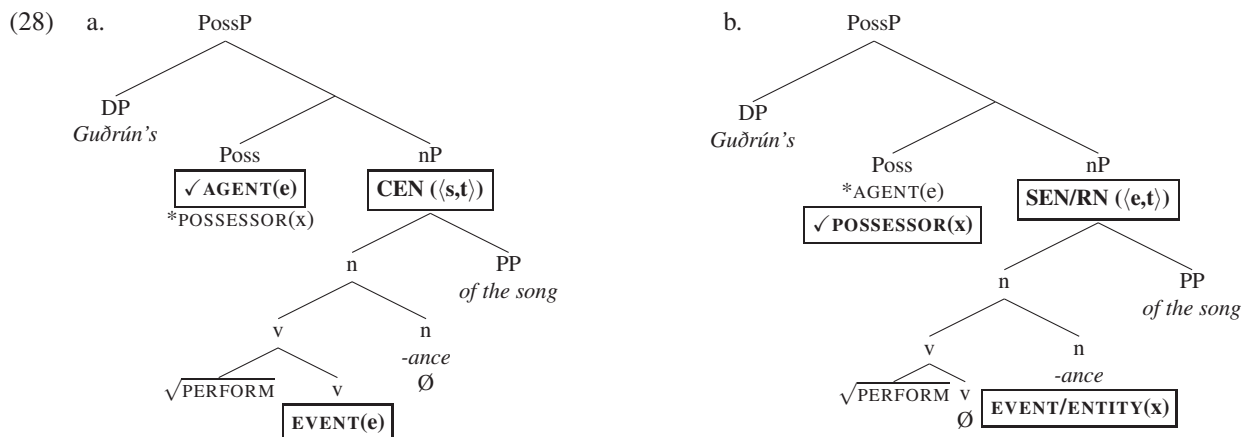

The telic modifier *in two minutes* can attach syntactically to the nP, but semantically, it is only compatible with reading generated in (28a), not (28b). Likewise, the agent alloseme is only compatible with the reading in (28a), where the eventive meaning comes from the verb, and the possessor reading is only compatible with the reading in (28b), where the eventive (or even non-eventive) meaning comes from the noun, and is type-theoretically an entity.<sup>11</sup>

Recall from chapter 2 that in general, the genitive DP can only be interpreted as an agent if there is some expression of the theme, either as a PP or as the non-head of a compound. The present analysis explains this asymmetry as follows. If the genitive is introduced as the complement of n, then it must be a theme; no external argument reading will be available, as there is no Poss head in the structure at this point to introduce it. Once this theme genitive is present, it will prevent any other genitive from merging into the structure. The same holds for synthetic compounds, as we will see—the nonhead must be interpreted as expressing the theme relation. So it still cannot be interpreted as an agent.

<sup>8</sup> I would go as far as to suggest that if a vP could refer to a simple entity, like 'table', then Voice would be able to introduce a possessor the way that Poss can.

<sup>9</sup> Thanks to Julie Legate for bringing this point up in this context.

<sup>10</sup> Recall from section 2.3.1 that RNs and SENs can take (what appear to be) internal arguments.

<sup>11</sup> For present purposes, I take the various possessor readings, such as the performance that Guðrún attended, the one she is always talking about, etc., as being a matter of vagueness of what it means to be a possessor. This is for convenience; it could be that there are different allosemes, but what matters here is that they would all be allosemes connected with an entity reading, not a complex event meaning.

The only way to get an agentive genitive is to build the full event, including the theme, by the nP level (either with the theme as a PP or the theme as a compound nonhead), and introduce the genitive in SpecPossP.

It should be clear by now that according to the present system, argument structure inheritance strictly speaking only pertains to the internal argument. It is the verb's meaning, along with the kind of object the verb is expected to take, that is inherited by the derived noun. The external argument meaning is not inherited from the verb or any phrase that the verb might have projected: it is neither inherited nor obligatory (that is, not automatically). However, there is a sense in which inheriting the verbal meaning is enough, because Poss can then serve the function of Voice, and both treat the object they combine with (the nP or vP, respectively) in the same way.

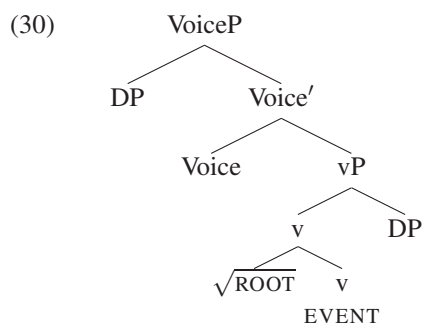
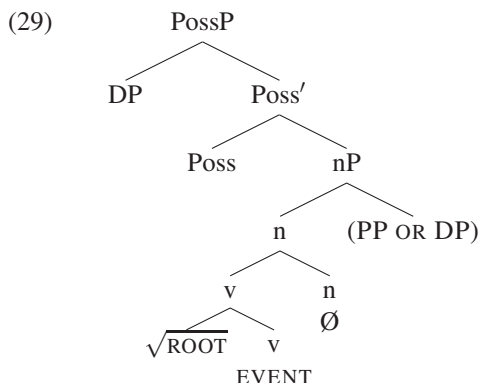

When the derived noun has the same meaning as the verb it is derived from, it combines with the object (whether that is syntactically a DP or PP) in the same way as the verb would, creating an nP that has the same semantics that a vP would. The relationship between Voice and a vP operates in the same way as the relationship between Poss and nP: the meaning of the former is negotiated semantically based on the meaning of the latter. When the meaning of an nP is the same as a corresponding vP would be, the result is the same: an agentive alloeme for an agentive event. This, then, is where parallelism of the sort found in Chomsky 1970 and Marantz 1997 comes into the present analysis.

### 5.1.4 Voice diagnostics or agent diagnostics?

Recall that we have seen that the only Voice diagnostics that Icelandic derived nominals pass have to do with agentive modifiers, like purpose clauses, comitative PPs, instrument PPs, manner/agent PPs, and *without*-phrases. The present analysis offers a solution as to why these tests, but not the others, make it seem as though Voice is there. In fact, all that we need to say is that these modifiers can attach to PossP in the way that they can also attach to VoiceP.

- (31) a. söfn-un      Darwins      á sveppum      með aðstoðamanni sínum  
 collect-NMLZ Darwin.GEN on mushrooms with assistant      REFL.POSS  
 'Darwin's collection of mushrooms with his assistant'

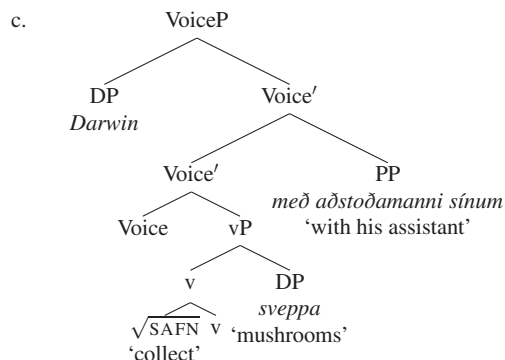
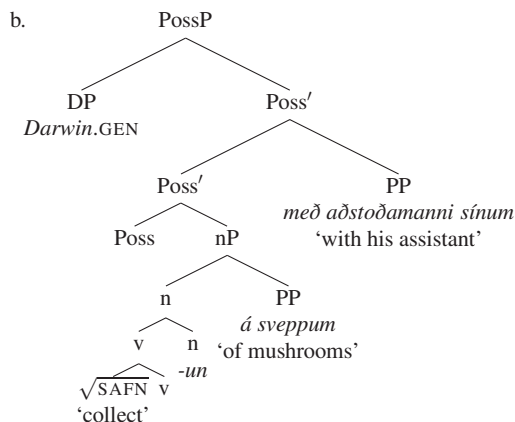

Since PPs generally do act as modifiers in DPs, this is a straightforward and relatively innocent assumption from a syntactic standpoint. Semantically, since PossP can have the same meaning that a VoiceP would have, the modifiers are interpreted at that level in the same way that they would be interpreted at the VoiceP level. The PP modifier tests therefore do not actually show that a full verb phrase, projecting a phrasal VoiceP, is present. The tests that truly diagnose Voice, such as overt Voice morphology, are consistent with Voice not being there at all.

In fact, the present analysis offers an avenue to explain a striking difference between nominalizations and verb phrases that is puzzling under a Phrasal Layering analysis. In some languages, including Icelandic, passive by-phrases as such are not possible in nominalizations, but something similar to them are possible. In Icelandic, nominalizations allow the agent to be named in *af hálfu* ‘on the part of’ phrases. The examples in (32) are repeated from (105b) and (106).

- (32) a. eyðilegg-ing borgarinnar (\*af óvininum)  
destr-NMLZ city.the.GEN (\*by enemy.the.DAT)  
‘the destruction of the city by the enemy’
- b. eyðilegg-ing borgarinnar af hálfu óvinnarins  
destroy-NMLZ city.the.GEN by part enemy.GEN  
‘the destruction of the city by the enemy’

If nominalizations are built on a VoiceP, as has been proposed for English, we would expect that the by-phrases that are allowed in VoicePs are allowed in nominalizations; this is in fact exactly Bruening’s (2013) argument. But why, then, is it that some languages do not allow this, and that a totally different kind of syntactic constituent is necessary? In the present analysis, the difference can be pinned to the fact that the modifier is attaching syntactically to a different position; different modifiers in general have different syntactic distributions. Semantically, if a by-phrase could attach to PossP, it would work just fine. But the syntax of some languages restricts the distribution of by-phrases, and their function may have to be “re-engineered” with some other kind of constituent (often a syntactically more complex constituent). Since the present analysis places modifiers of nominalizations in a syntactically different position, nothing forces all modifiers to be allowed to attach there. Most agentive PP modifiers can attach to PossP, but agentive by-phrases are not among them. If nominalizations contain a VoiceP, it is really unclear what would prevent VoiceP modifiers of any kind.

The reason that tests like purpose clauses, comitative PPs, instrument PPs, manner/agent PPs, and *without*-phrases seem to test for a VoiceP layer in the verbal/clausal domain is that what they are really testing for is the presence of a semantic agent. In the verbal domain, a VoiceP layer of a certain kind is required to introduce a semantic agent. Without a VoiceP (or a proper “agentive” VoiceP), there is no semantic agent for these modifiers to modify, so they fail. Take, for example, a contrast such as the following:

- (33) a. # The window opened on purpose.  
b. The window was opened on purpose.

The modifier *on purpose* needs an entity argument to modify to say that entity’s involvement in the event (and perhaps the result of the event, etc.) was volitional, under the entity’s control, etc. An agent is the best example of this, so the most salient reading of (33b) is that the implicit agent that is introduced as part of the verbal passive is the entity in question. (33a) is deviant because the only entity available in the structure to modify is denoted by *the window*, and it is hard or impossible to conceive of a window in this way. It is not about having a VoiceP per se; it is about having a potentially agentive entity in the semantics.

In fact, there are at least two ways that (33a) shows that agentivity diagnostics are not necessarily about Voice. First, many accounts of unaccusative anticausatives would assume an expletive VoiceP in (33a), so it is truly about the interpretation of Voice, not the presence of the syntactic head. Second, there is a possible reading of (33a) in which the window is anthropomorphized, sentient and opening intentionally on its own. This reading seems absurd, but it is perfectly possible to talk about absurd things, and there is no reason to assume that that reading requires a VoiceP. In fact, the reading can be brought out with negation, as in *Windows can’t open on purpose*. Moreover, there are many cases of unaccusatives with sentient internal arguments which are compatible with adverbials like *on purpose*, purpose clauses, and so on.

- (34) a. She arrived late {on purpose / to make me angry }.  
b. She grew up (so quickly) {on purpose / to break my heart }.

- c. The witch melted {on purpose / to make Dorothy feel bad }.

Examples like this can be enumerated with *explode, collapse, fall, die, shrink, freeze*, etc. Some may seem absurd, but they are linguistically coherent. For example, (34b) could be uttered by a parent who is struggling with how quickly children seem to grow up, either in earnest (blaming the child, even if it is irrational) or in a tongue-in-cheek manner, knowing it is not true. Either way, linguistically, the sentence can attribute this kind of intentionality to the internal argument subject.

Let us now return to the present account of nominalizations. If it is true that the agentivity diagnostics under consideration do not test for Voice, but rather test for a particular kind of interpretation that Voice generally introduces, then in nominalizations what these diagnostics show us is that this kind of interpretation is available in nominalizations. According to my account, there is not—or at least need not be—any Voice head, and these diagnostics do not force us to conclude that there is a Voice head. Rather, the Poss head is able to introduce the same kind of semantics with an nP that the Voice head would introduce with a vP, in particular because the nP complement of Poss can have the exact same meaning that the vP complement of Voice would have. The modifiers given above, such as *on purpose*, that are usually taken to diagnose the presence of Voice really diagnose not Voice, but something that Voice *does*—introduce an agent—which is something that Poss can also do in right circumstances.

### 5.1.5 A note on Borer's Generalization

The system developed in this book is based on the assumption that Borer's Generalization holds: a certain reading that nouns can have (the CEN reading) entails the existence of a morphologically-related verb with that same meaning. I believe that this is a strong enough generalization to not only take it seriously, and not only hard-wire it into the system, but make it fall out of the architecture of grammar in as deep and straightforward a way as possible. In the present system, it falls out from a couple of assumptions about the architecture of grammar. The first is that the syntactic category of verb is semantically special, in that it can introduce a kind of event variable—the variable at the heart of constructing the complex event meaning—that cannot be introduced by any other category. For a noun to get a CEN reading, it therefore must contain a verb. Note that this assumption is shared by the present theory and Phrasal Layering analyses. The second is that there is no root suppletion, or at least that n cannot condition root suppletion past v.<sup>12</sup> If n could condition root suppletion past v, then we would never have noticed Borer's Generalization to begin with: suppleted verbal roots in the context of n would simply look like distinct nouns with CEN meaning. To illustrate, consider the pair of sentences in (35) from Borer (2014, 78) (who is responding to Newmeyer 2009).

- (35) a. Mary's metamorphosis of the house (made it unrecognizable)  
 b. the metamorphosis of the house (\*by Mary) (\*in order to erase the traces of her ex-lover)

(35a) appears to have arguments that might resemble a verb or CEN—parallel to *Mary changed the house*—but there is no verb morphologically related to the noun *metamorphosis*. Borer (2014) points out that this is not an exception, because although *metamorphosis* appears to be able to take arguments, it in fact fails CEN diagnostics, as shown in (35b). But suppose that we had a system where  $\sqrt{\text{CHANGE}}$  is realized as follows:

- (36) a.  $\sqrt{\text{CHANGE}} \leftrightarrow \text{metamorphosis} / [n [v \_ v] n]$   
 b.  $\sqrt{\text{CHANGE}} \leftrightarrow \text{change} / [v \_ v]$

In that case, *metamorphosis* would pass CEN diagnostics, because in fact, it *would* be related to a verb (the verb *change*), just unrecognizably so. If Borer's Generalization is correct, then there can be no true root suppletion, and Vocabulary Items like (36a) cannot exist.<sup>13</sup>

<sup>12</sup> Relatedly, non-terminal node Vocabulary Insertion of the sort in Bobaljik (2012) must also not be allowed, or at least not allowed at the n level in a way that would make the verbal root and little v morphologically unrecognizable. See, for example, Borer's (2014) point about how CAUSE+EAT could not be spelled out together as 'feed', and, more importantly, the non-terminal n-node of a  $\sqrt{\text{ROOT}+v+n}$  structure could not be spelled out with a single monomorphemic exponent. If non-terminal node Vocabulary Insertion is limited to spans in the sense of Svenonius (2012, 2016), then  $\sqrt{\text{ROOT}+v+n}$  must not count as a span (which, in fact, they wouldn't, if the present account is correct that the root is not a complement of v, and  $\sqrt{\text{ROOT}+v}$  is not a complement of n).

<sup>13</sup> At least, not conditioned by n past v. Technically, this could be an argument about the locality of root suppletion, rather than the existence of root suppletion. What is important in the present case is that n cannot in any way condition root suppletion past v in a  $\sqrt{\text{ROOT}+v+n}$  structure.

It is worth considering briefly what it would mean if Borer's Generalization turned out to be incorrect. Suppose it is completely wrong—that it was an illusion, and there is nothing to it, at least not in the grammar. (For example, it is only a weak tendency, that holds for diachronic rather than architectural reasons.) That could mean that one of the two assumptions mentioned above are wrong: either *n* is able to introduce the same kinds of event variables that *v* is, or *n* can condition root suppletion past *v*, or both. It would also mean that some of the assumptions guiding the analysis of Icelandic in the previous chapters would have to be re-examined, because some of them were based on the assumption that the existence of a CEN reading can tell us that a *v* head is present.

However, many of the points would still stand, as the primary purpose was to show that CENs can be derived without verb phrases, even if there must be a verb in the structure. This still holds because in many cases there is an overt verbalizing morpheme, and still no verb phrase. So for those cases, the same issues of inheritance of verbal meaning and the CEN reading without the presence of a verb phrase are still present. Moreover, Phrasal Layering analyses would be in even more trouble: if not even a verb is required, then certainly a verb phrase is not necessary either. If the issue is that suppletion exists, but the CEN reading does require a verb, then the problem may be motivating the verbal layer in the first place, whether it is the verbal head alone (as in this account) or the head of a verb phrase (as in the Phrasal Layering account). The assumption about the eventive meaning of verbs being special would be correct, just much more difficult to verify. In this case, most of what is claimed in this book would still hold, and little would have to be changed; but the morphological basis of the assumption would be lost, and it would have to be discovered in some other way.

Suppose instead that Borer's Generalization largely holds, but there are a few exceptions. It is worth pointing out that the present system does allow for this possibility, although it is likely to be rare. First, consider the morphological side, where I assume that *n* cannot condition suppletion of the root past *v*. Here, I am taking the position that suppletion is formally distinct from morphophonological readjustment. For example, *destroy* can become *destruct-* in *destruction*. Here, there is enough morphophonological resemblance that native speakers can detect the connection between the two, supporting a readjustment rule. I assume that *n* can trigger idiosyncratic morphophonological rules past *v* to make this change. (I assume *v* is present, of course, because *destruction* can have a CEN reading.) However, there is as of now no well-established theory of just how much a readjustment rule can change something. Depending on what one considers suppletion, and what the theory of readjustment turns out to be, it is possible that in some cases, a noun will trigger enough changes, even past *v*, to make the root look like it has undergone suppletion. This would be rare, however, because it would have to somehow be reliably acquired by native speakers so that they recognize and internalize the morphological relation between the verb and the noun. It would not be surprising if, in such circumstances, many speakers began to use the “suppleted”/“new” nominal form as a verb, and/or began using a more predictable form of nominalization of the verb.

Second, consider the semantic side. Since we know there are conditioned allomorphic interactions between the root, *v* and *n*, there could in principle be unusual allosemantic interactions between these elements in particular cases. For example, in Icelandic, the most common nominalization of the verb *nota* ‘use’ is *not-k-un*.

- (37) a. Öll **not-k-un** tóbaks er bönnuð (á svæðinu).  
all use-VBLZ-NMLZ tobacco is banned in place.the  
‘All use of tobacco is banned in this area.’
- b. Það er bannað að **nota** tóbak.  
it is banned to use tobacco  
‘Using tobacco is banned.’

In this form, it appears as though the verbalizer *-ka* has shown up in the nominal form even though it is not present in the verb it is based on.<sup>14</sup> One can imagine a Vocabulary Insertion rule here where the context for realizing *v* as *-ka* is a particular root *and* a higher *n* head.

$$(38) \quad v \leftrightarrow -ka / \sqrt{\text{NOT}} \frown \_ \frown n$$

If this kind of VI is possible on the morphological side, it would be possible, at least in principle, to have something like it on the semantic side. For example, one could formulate an alloseme that says that *v* gets, say, an activity reading only

<sup>14</sup> In fact, the verb *notka* does exist, but has a more specialized meaning along the lines of ‘utilize’. The nominalization *notkun* appears to be broader, corresponding to the more general uses of *nota* ‘use’.

in the context of a particular root and a higher  $n$  head, and not otherwise.<sup>15</sup> This would then appear as a nominalized verb (which could have a CEN reading) that never appears unless it is in a nominalization. If little  $v$  is not overt, it would just look like a noun with a CEN reading. Here again, I assume that this set of circumstances should be quite rare, since it would take a lot for a speaker to acquire it. Even then, as above, I would assume that many speakers would be likely to simply start using the underlying verb in verb phrases, or at least that they would find such uses to be possible.<sup>16</sup> So this is the kind of analysis that could apply to a limited set of exceptions to Borer's Generalization, but would not be appropriate if Borer's Generalization is completely incorrect, and a large number of nouns with no morphological relationship to existing verbs systematically allowed CEN readings.

Despite these possibilities within the current system, I believe that the general picture is one where Borer's Generalization holds, and therefore argue for an architecture of grammar where it falls out of the system as the default case. To summarize, I assume that it holds because (a) verbs are semantically special, and (b) nominalization cannot trigger root suppletion. Both of these must be assumed by proponents of Phrasal Layering analyses as well, at least if the basis of the argument in favor of Phrasal Layering is to be upheld. If Borer's Generalization has some scattered exceptions, I have outlined two ways that this could happen, one based on allosemy and one based on morphological readjustment. If Borer's Generalization is fundamentally wrong, many basic aspects of the present account can be maintained, although the assumptions underlying some of the analyses would have to be re-examined.

## 5.2 The interpretation of nominals, building event structure

I now turn to a somewhat more complex set of assumptions about the basic construction of eventive verbal meaning. To show how the basic system works, I have made certain simplifications to the semantics in section 4.1. This includes the ways that roots are integrated into event structure and the use of a thematic role "theme". If the reader is happy with such simplifications, they may skip this section. However, research on the semantics of roots and event structure leads me to show what the system looks like if these simplifications are abandoned. Specifically, in this section we abandon the theme role, and assume that event structure is constructed. In order to extend this view to nominals, it is necessary to formulate the rules involved in event structure construction in a way that does not refer specifically to verbs, verb phrases, and the like, and this is the task of this section.

### 5.2.1 The interpretation of roots and themes

This section will address two related issues. First, the present proposal requires that verbal roots are generally first-merged with  $v$ , and not with the complement of  $v$ . This is so even with roots that denote end-states like  $\sqrt{\text{OPEN}}$  or  $\sqrt{\text{CLEAR}}$ . While this assumption has been made in some recent work (Marantz, 2013a,b, 2018), it is far from universally accepted, and bears further scrutiny. More commonly, it is assumed that roots denoting end states are merged in the complement of  $v$ , sometimes attached to the DP. I will show how change-of-state semantics can be encoded internally to the complex head, without merging the theme.

Second, various works, but Wood & Marantz 2017 in particular, propose that theme roles do not exist in the way that agent or beneficiary roles do. Rather, what we call the theme is a DP that is part of the construction of the event structure semantically. Wood (2015) proposed that this works by coercing a DP to refer to the state of that DP;  $v$  is then interpreted as the event that causes that end state. This section will integrate this basic idea into the semantics of nominalizations, which requires specific technical revisions, which I argue are closer in spirit to the original idea than previous implementations of it. In essence, the deverbal noun inherits the activity meaning of the verb, and the juxtaposition of this and the end state denoted by the DP leads to a change of state interpretation (for change-of-state themes). The results simplify the denotations inserted as contextual allosemes, and shift some of the semantic burden for event construction to the interpretive component.

<sup>15</sup> Formally, one could say that it gets a zero interpretation otherwise, which would mean that it does not introduce any event variable in an ordinary verb phrase, and therefore would not be semantically useable in a verb phrase.

<sup>16</sup> This is at the heart of so-called backformation processes. Speakers tend to assume that words are decomposed, and that the parts can be used independently.



First, consider verbs with roots denoting the manner of the activity, such as ‘paint’. I assume that the normal semantics of little *v* for such verbs is simply an event variable denoting an activity.

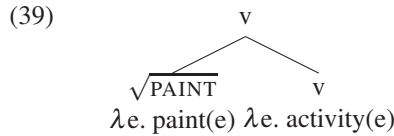

The root and *v* can then combine by simple Predicate Conjunction, to denote an event that is an activity and is a painting event.

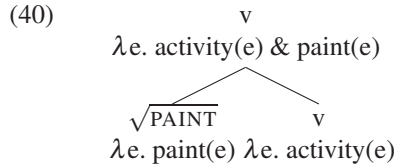

When *v* combines with a direct object DP, there is no automatic way to combine the denotation of *v* and the denotation of DP. In such cases, the system will by default build a change of state interpretation. This is done in two steps. First, there is a general state coercion rule that may apply in the grammar when it is needed or triggered.

(41)  $\llbracket \text{DP} \rrbracket \rightarrow \text{STATE}(\llbracket \text{DP} \rrbracket) = (\lambda x \lambda s. \text{state}(s)(x))(\llbracket \text{DP} \rrbracket)$

This general rule can be invoked in a specific case, as in (42).<sup>17</sup>

(42) If  $\alpha$  is a branching node, and  $\{\beta, \gamma\}$  is the set of  $\alpha$ 's daughters, and  $\beta$  is of type  $\langle s_e, t \rangle$  and  $\gamma$  is of type  $e$ , then  $\llbracket \alpha \rrbracket \rightarrow \text{STATE}(\llbracket \gamma \rrbracket)$ .

Second, there is a default composition rule introducing a cause relation between a set of events and a set of states, which I define as in (43).<sup>18</sup>

(43) **Cause Rule**  
 If  $\alpha$  is a branching node, and  $\{\beta, \gamma\}$  is the set of  $\alpha$ 's daughters, and  $\beta$  is in  $D_{\langle s_e, t \rangle}$  and  $\gamma$  is in  $D_{\langle s_s, t \rangle}$ , then  $\llbracket \alpha \rrbracket = \lambda s \lambda e. \text{cause}(e)(s) \ \& \ \llbracket \beta \rrbracket(e) \ \& \ \llbracket \gamma \rrbracket(s)$

Applying these two rules yields the structure and interpretation in (44).

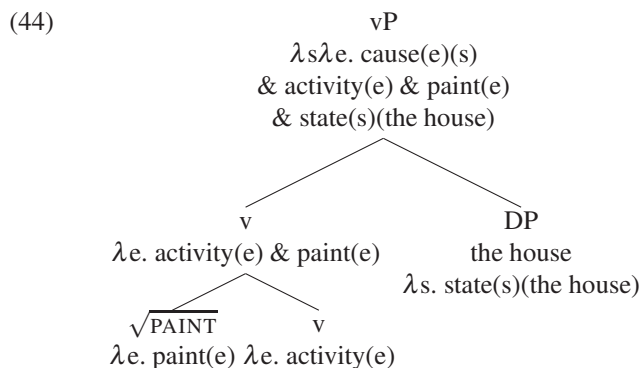

Finally, the state variable undergoes existential closure, leaving the activity variable as the only lambda bound variable. This gives the *vP* the denotation in (45).

<sup>17</sup> An alternative to the composition rules proposed here that I have not considered in detail yet would be to insert Dissociated Nodes into the syntactic structure at LF, and tie the interpretations to those nodes, as is proposed for the interpretation of attributive compounds in recent work by Ingason & E.F. Sigurðsson (2020).

<sup>18</sup> Notice that unlike the rule in Wood & Marantz (2017), the formulation of these rules does not make explicit reference to any syntactic category, like *v* or DP.

(45)  $\llbracket \text{paint the house} \rrbracket = \lambda e \exists s. \text{cause}(e)(s) \ \& \ \text{activity}(e) \ \& \ \text{paint}(e) \ \& \ \text{state}(s)(\text{the house})$

When the root names the end state of a change of state, the composition will proceed differently, but according to the same principles. First, I assume that the root will be interpreted as a set of states, and that *v* will still be interpreted as an activity.

(46)

$$\begin{array}{c} v \\ \swarrow \quad \searrow \\ \sqrt{\text{OPEN}} \quad v \\ \lambda s. \text{open}(s) \quad \lambda e. \text{activity}(e) \end{array}$$

However, unlike above, this does not combine by Predicate Conjunction. Instead, it meets the structural description for the same cause rule that applied at the *vP* level above, namely (43). Here, it applies at the *v*-head level.<sup>19</sup>

(47)

$$\begin{array}{c} v \\ \lambda s \lambda e. \text{cause}(e)(s) \\ \& \ \text{activity}(e) \ \& \ \text{open}(s) \\ \swarrow \quad \searrow \\ \sqrt{\text{OPEN}} \quad v \\ \lambda s. \text{open}(s) \quad \lambda e. \text{activity}(e) \end{array}$$

When this verb combines with a DP, just as above the DP will be coerced to be interpreted as a set of states. This time, however, the DP can combine with the verb by a kind of conjunction rule—what we might call State Identification (on analogy with Event Identification); for more details, see section 1.3.2.3, where this is an instance of what is called “X Identification 2”.)

(48)

$$\begin{array}{c} vP \\ \lambda s \lambda e. \text{cause}(e)(s) \\ \& \ \text{activity}(e) \ \& \ \text{open}(s) \\ \& \ \text{state}(s)(\text{the door}) \\ \swarrow \quad \searrow \\ v \quad DP \\ \lambda s \lambda e. \text{cause}(e)(s) \quad \text{the door} \\ \& \ \text{activity}(e) \ \& \ \text{open}(s) \quad \lambda s. \text{state}(s)(\text{the door}) \\ \swarrow \quad \searrow \\ \sqrt{\text{OPEN}} \quad v \\ \lambda s. \text{open}(s) \quad \lambda e. \text{activity}(e) \end{array}$$

As before, the state variable is existentially closed, yielding the *vP* semantics shown in (49).

(49)  $\llbracket \text{open the door} \rrbracket = \lambda e \exists s. \text{cause}(e)(s) \ \& \ \text{activity}(e) \ \& \ \text{open}(s) \ \& \ \text{state}(s)(\text{the door})$   
 $\approx$  ‘The set of activity events *e* that cause the state of the door to be in state *s*, the state of being open’

Note that the nature of the activity of the causing event is unspecified, since the root names the end state.

A final kind of root that is worth discussing is a predicate of entities, such as  $\sqrt{\text{PILE}}$ . When used in a verb phrase, it entails the creation of a pile: if I pile the books, there exists a pile (Levinson, 2007, 2010, 2014; Kastner & Irwin, 2018). The books still point to an end state, however. The books are in a state characterized by the properties of a pile. I assume, following previous work, that roots like  $\sqrt{\text{PILE}}$  are predicate of entities, and that *v* still denotes and activity.

(50)

$$\begin{array}{c} v \\ \swarrow \quad \searrow \\ \sqrt{\text{PILE}} \quad v \\ \lambda x. \text{pile}(x) \quad \lambda e. \text{activity}(e) \end{array}$$

<sup>19</sup> This analysis is inspired in part by the discussion of roots in Alexiadou (2009). Note at this point that the analysis as it stands derives, at least in the basic case, manner/result complementarity (on which see Levin & Rappaport Hovav 1991, 2013; Rappaport Hovav & Levin 2010), where a root lexicalizes/identifies either the result of an event, its manner, but not both. See Beavers & Koontz-Garboden (2012) for (apparent) counterexamples to manner/result complementarity, and Levin & Rappaport Hovav (2013, 2014) for a reply.

As above, these denotations cannot compose directly. However, we already have a state coercion rule applying to DPs, as in (41) above, repeated here:

$$(51) \quad \llbracket \text{DP} \rrbracket \rightarrow \text{STATE}(\llbracket \text{DP} \rrbracket) = (\lambda x \lambda s. \text{state}(s)(x))(\llbracket \text{DP} \rrbracket)$$

What is needed, I suggest, is to apply a minimally different rule, which also introduces a state but along with existential closure over the entity variable of the root.

$$(52) \quad \llbracket X_{\langle e,t \rangle} \rrbracket \rightarrow \text{STATE}(\llbracket X_{\langle e,t \rangle} \rrbracket) = (\lambda P_{\langle e,t \rangle} \lambda s \exists x. \text{state}(s)(x) \& P(x))(\llbracket X_{\langle e,t \rangle} \rrbracket)$$

Note that this is formulated to apply not just to roots, but anything of type  $\langle e,t \rangle$ , and will play a role in the analysis of synthetic compounds below. In the present case, applying this rule to the root  $\sqrt{\text{PILE}}$ , we get a representation like (53).

$$(53) \quad \begin{array}{c} v \\ \swarrow \quad \searrow \\ \sqrt{\text{PILE}} \quad v \\ \lambda s \exists x. \text{state}(s)(x) \quad \lambda e. \text{activity}(e) \\ \& \text{pile}(x) \\ | \\ \lambda x. \text{pile}(x) \end{array}$$

From here, everything proceeds as above, compositionally. The verb will be interpreted with the causative rule, and can take a DP object, which will also be interpreted as the result state of the causing event.

$$(54) \quad \begin{array}{c} vP \\ \lambda s \lambda e. \text{cause}(e)(s) \\ \& \text{activity}(e) \\ \& \exists x. \text{state}(s)(x) \\ \& \text{pile}(x) \\ \& \text{state}(s)(\text{the books}) \\ \swarrow \quad \searrow \\ v \quad \text{DP} \\ \lambda s \lambda e. \text{cause}(e)(s) \quad \text{the books} \\ \& \text{activity}(e) \quad \lambda s. \text{state}(s)(\text{the books}) \\ \& \exists x. \text{state}(s)(x) \\ \& \text{pile}(x) \\ \swarrow \quad \searrow \\ \sqrt{\text{PILE}} \quad v \\ \lambda s \exists x. \text{state}(s)(x) \quad \lambda e. \text{activity}(e) \\ \& \text{pile}(x) \\ | \\ \lambda x. \text{pile}(x) \end{array}$$

The only difference from the state roots above is that here it is asserted that there exists a pile which is in state  $s$  and the books are in state  $s$ —so the books and the pile point to the same state.<sup>20</sup> Again, the state is existentially closed, leading to the following denotation for *pile the books*.

$$(55) \quad \llbracket \text{pile the books} \rrbracket = \lambda e \exists s. \text{cause}(e)(s) \& \text{activity}(e) \& \exists x. \text{state}(s)(x) \& \text{pile}(x) \& \text{state}(s)(\text{the books}) \\ \approx \text{‘The set of activity events } e \text{ that cause the state of the books and an entity } x \text{ to be in state } s, \text{ and } x \text{ is a pile’}$$

<sup>20</sup> I suspect that this difference can also account for pseudo-resultative constructions such as “Guðrún piled the books high” or “Guðrún braided her hair tight”, where it is the pile (or braid)—or perhaps the state of the pile (or braid)—that is high (or tight), but I leave this for future research. See Levinson (2010) for detailed discussion of pseudo-resultatives.

Note that the nature of the activity of the causing event and the actual end state is unspecified. Instead, the books and the existence of an entity which is a pile are both asserted to be in the same state. Since the notion of a pile defines an arrangement of entities, and this arrangement along with a concrete set of entities are asserted to be in the same state, this is understood as the concrete entities (the books) and the existing arrangement (the pile) point to the same entity, by virtue of being predicated of the same state of affairs.

With this much in place, we can see how a root adjoined to *v* can name the manner, result state, or an entity. We can now also see how the same meanings are built in nominalizations. Essentially, everything works the same as long as none of the rules above depend on a structural adjacency between *v* and DP—and indeed, none of the rules formulated above do. If a deverbal *n* head has the same denotation as the *v* head embedded in it, and PP complement has the same denotation as the DP embedded in it, then the semantic composition will proceed exactly as it does in the case of a verb phrase.

### 5.2.2 Experiencer verbs and stimuli

We are now able to return to some facts brought up in chapter 3 (section 3.1.5) regarding experiencer verbs, which raise the general question of what kinds of thematic relations can be expressed by the genitive, and what can be expressed by the *á*-PP. Consider first the example of *misheyrast* ‘mishear’ and its nominalization *misheyrn*. (56) is repeated from (41) in chapter 3.

- (56) Þér hafa víst misheyr-st orð mín!  
 you.DAT have surely misheard-ST words my  
 ‘You have surely misheard my words!’
- a. Misheyr-n Jóns olli vandræðum.  
 mishear-NMLZ Jón.GEN caused problems  
 ‘Jón’s mishearing caused problems’
- b. Misheyr-n Jóns á orðum mínum olli vandræðum.  
 mishear-NMLZ Jón.GEN on words my caused problems  
 ‘Jón’s mishearing of my words caused problems’

First, consider that the genitive can be the experiencer, whether the object is present or not, but is not naturally interpreted as the stimulus, at least for some speakers. Second, consider that the *á*-PP can be the stimulus, but cannot be the experiencer.

What this suggests is that with a nominal like *misheyrn*, we do not simply have a relation between a the embedded verb and a DP object that can be computed the way that themes were argued to be computed above. More specifically, this *n* cannot take a genitive complement at all, presumably because there is no way to interpret it. Instead, any genitive is derived by external merge in SpecPossP. I assume that the verb denotes an experience, and that given that, Poss will introduce an experiencer role, whether the stimulus is expressed in the structure or not.<sup>21</sup>

- (57) a.  $\llbracket \text{Poss} \rrbracket \leftrightarrow \lambda x \lambda e. \text{EXPERIENCER}(x)(e) / \_ \text{ experience event}$   
 b.

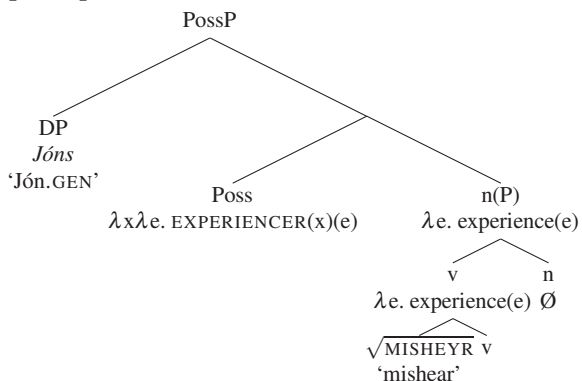

<sup>21</sup> Note that the stimulus is optional with the verb *misheyrast* ‘mishear’ as well.

When the stimulus is present, it must be the *á*-PP. I propose that this is because here, *á* is not semantically  $\emptyset$ , but rather is co-opted by the system to introduce stimulus semantics.

Wood (2015) tied stimulus semantics to a low Appl head that introduces both the experiencer (as a specifier) and the stimulus (as a complement).

- (58) a.
- 
- b.  $\llbracket \text{Appl} \rrbracket \leftrightarrow \lambda P_{\langle s,t \rangle} \lambda x_e \lambda e_s \exists e'_s. P(e') \wedge \text{experience}(e) \wedge \text{EXPERIENCER}(x,e) \wedge \text{source}(e',e)$

Here, I would like to decompose some of the semantic components of (58b), and propose that the stimulus is introduced separately, as a contextually determined alloeme of the preposition *á*, as shown in (59).<sup>22</sup> This denotation needs to combine with something of type  $\langle s,t \rangle$ , and the DP is coerced to be understood as such an event. At this point, it may combine with the P by Functional Application. The n may then combine with the PP by Predicate Conjunction.

- (59) a.  $\llbracket P_{\acute{a}} \rrbracket \leftrightarrow \lambda P_{\langle s,t \rangle} \lambda e \exists e'. P(e') \& \text{source}(e')(e)$
- b.
- 

If Poss merges and takes a specifier, it will introduce the experiencer, just as above.<sup>23</sup>

We now return to another case discussed in chapter 3, *vanta* ‘need’ and its nominalization *vöntun*. The example in (60) is repeated from (39) in chapter 3.

<sup>22</sup> It would be worth considering whether this Appl head should be decomposed in general, even within the verb phrase. The “experience(e)” conjunct should almost certainly come from the v head, for one thing. For another, the present discussion suggests separating the experiencer and the source. It is perhaps relevant to note that a number of low applicative experiencer and ingestive constructions seem to have a PP complement of Appl rather than a DP complement (see Wood 2015, 236–246). However, one could also imagine stimulus semantics in structures like (58a) being introduced by a general rule of interpretation along the lines of the cause rule in (43). In fact, it could simply be the cause rule—if Appl introduces a set of states with an experiencer, and its complement denotes an event, then the cause rule would say that the event of the complement causes this state, which is fairly close to what is intended by analyzing the stimuli of experiencers as sources. For now, I leave this for future work.

<sup>23</sup> Interestingly, according to Sigríður Mjöll, *aðdáum* ‘admiration’ works the same way, even though it is derived from a verb with a completely different argument marking pattern *dást að*, with a PP object and P-prefixing in the nominalization. This supports the claim that argument structure in nominal domain is built up independently of verb phrase syntax.

- (60) Fyrirtækið vantaði gott starfsfólk.  
 company.the.ACC needed good employees.ACC  
 ‘The company needed good employees.’
- a. vönt-un góðs starfsfólks  
 need-NMLZ good employees.GEN  
 ‘the need of good employees’ (ambiguous)
- b. vönt-un fyrirtækisins á góðu starfsfólki  
 need-NMLZ company.the.GEN on good employees.DAT  
 ‘the company’s need of good employees’

Note here that what I will call the ‘target’ (the thing needed) can occur either as a genitive or as an *á*-PP (but the experiencer must be a genitive, not an *á*-PP). This then suggests a treatment along the lines of themes above: the noun is interpreted as the verb is, the target is computed from the juxtaposition of the the verb meaning and the meaning of the DP. As above, the experiencer cannot be introduced as an *á*-PP. This suggests that when the experiencer is expressed as a genitive, that genitive cannot be a complement of n, but must be introduced in SpecPossP (which is entirely consistent with what was just said above). Thus, the ambiguity of the interpretation of (60a) is in fact a structural ambiguity, along the lines shown in (61a–b): (61a) corresponds to the target interpretation and (61b) corresponds to the experiencer interpretation. When both arguments are present, as in (61c), the complement of noun is unambiguously the target and the specifier of Poss is unambiguously the experiencer.

- (61) a. **Target**
- 
- b. **Experiencer**
- 
- c. **Target and Experiencer**
- 

The difference between *misheyrn* ‘mishearing’ and *vöntun* ‘need’ is that the target of *vöntun* ‘need’ can occur as a genitive DP complement, and does not need the preposition to introduce the appropriate thematic semantics; just like with themes, an expletive preposition can occur, but from a thematic/interpretive standpoint, it doesn’t have to. With *misheyrn* ‘mishearing’, the preposition is semantically contentful and therefore necessary. In both cases, the experiencer must be introduced by Poss, and the target or stimulus must be expressed by the complement. In general, these examples present us with the basic picture of how to understand cases where only the possessor or only the *á*-PP can express a certain relation. In such cases, we do not have the general computation of a verb and its argument with

a PP headed by a semantically  $\emptyset$  P or a genitive DP. Rather, the same structure is co-opted with different alloemes to facilitate interpretation. If only a genitive may express a certain relation, it generally means that that relation is expressed as an alloeme of Poss. If only  $\acute{a}$  may express a certain relation, it generally means that that relation is expressed as an alloeme of  $\acute{a}$ .

### 5.2.3 Agent Nominals

Most of this work is focused on what are traditionally referred to as event nominalizations, as well as the other meanings that morphological event nominalizations may have. Another major category of nominalization in many languages is often referred to as the agent nominal, where a derived nominal refers to the instrument or entity that performs the action of the verb. I do not address these in any depth in this work, as they raise numerous issues of their own. However, in the next section, I will discuss the interpretation of synthetic and primary compounds, and many of the examples of synthetic compounds discussed in the literature involve agent nominals. I will therefore provide a brief overview of agent nominals in Icelandic, and a sketch of how they might work within the system proposed in this book.

The class of nouns that serve as the most obvious translations of English agent nominals is not uniform in Icelandic, although the range of options is similar in some ways. There are roughly four strategies for forming agent nominals:

- (62) Strategies for forming agent nominals in Icelandic
- ari* suffixation: Based on the verb or noun, similar to root-derived *-er* in English
  - andi* suffixation: Resembles a present participle, no direct analogue in English
  - ingil-istil*/etc.: Based on nominal root, similar to *-ist*, *-ant*, etc., in English
  - maður/kona* compounding: Compounds headed by ‘man’ or ‘woman’

I will now briefly discuss each of these in turn.

The suffix *-ari* stands out at first glance as the closest analogue to *-er* in English, although there are differences in productivity and the range of uses and meanings it may have. The *-i* of *-ar-i* marks case, gender and number, like most weak masculine nouns. Grammatically, *-ari* nouns are always masculine, even when referring to someone who identifies as female, although all the issues that generally arise with mismatches in grammatical and semantic gender of course arise here as well (see H.Á. Sigurðsson (2019) and Thorvaldsson (2019) for discussion). Ingason & E.F. Sigurðsson (2015) discuss *-ari* in detail, comparing it with *-andi* (discussed below here), and propose that *-ari* is generally root-attaching rather than verb-attaching. First, they point out that there are *-ari* nouns that are not based on verbs. I reproduce their examples below:

- (63) *-ari* nouns not based on verbs (from Ingason & E.F. Sigurðsson 2015, ex.16)

|                               | Non-existing verb | Noun with same root      |
|-------------------------------|-------------------|--------------------------|
| <i>apótekari</i> ‘pharmacist’ | * <i>apóteka</i>  | <i>apótek</i> ‘pharmacy’ |
| <i>borgari</i> ‘citizen’      | * <i>borga</i>    | <i>borg</i> ‘city’       |
| <i>pönkari</i> ‘punk rocker’  | * <i>pönka</i>    | <i>pönk</i> ‘punk music’ |
| <i>sjóari</i> ‘seaman’        | * <i>sjóa</i>     | <i>sjór</i> ‘sea’        |

Second, they point out that some *-ari* nouns are based on the form that verbal roots take in nominal environments. As I mentioned earlier, some nominalizations in Icelandic are marked with a vowel shift. The verb *drepa* ‘kill’ becomes *dráp* ‘killing (n.)’. In numerous cases, the *-ari* form is built on the nominal form that the root takes, rather than the verbal form.<sup>24</sup>

<sup>24</sup> Note that the alternation between *-ö-* and *-a-* is a predictable result of the u-umlaut rule.

(64) *-ari* nouns based on nominal root form (from Ingason & E.F. Sigurðsson 2015, ex.17)

| <b>-ari noun</b>          | <b>Verbal form</b>           | <b>Nominal form</b>    |
|---------------------------|------------------------------|------------------------|
| <i>dráp-ari</i> ‘killer’  | <i>að drepa</i> ‘to kill’    | <i>dráp</i> ‘killing’  |
| <i>gjaf-ari</i> ‘giver’   | <i>að gefa</i> ‘to give’     | <i>gjöf</i> ‘gift’     |
| <i>lyg-ari</i> ‘liar’     | <i>að ljúga</i> ‘to lie’     | <i>lygi</i> ‘lie’      |
| <i>svik-ari</i> ‘traitor’ | <i>að svíkja</i> ‘to betray’ | <i>svik</i> ‘betrayal’ |
| <i>söngv-ari</i> ‘singer’ | <i>að syngja</i> ‘to sing’   | <i>söngur</i> ‘song’   |

Many verbs cannot form *-ari* nouns at all, which is also consistent with Ingason & E.F. Sigurðsson’s (2015) analysis. It is not clear, however, that *-ari* is always root-attaching, however, as there exist at least some instances of *-ari* nouns derived from verbs with overt instances of *v*, such as *þurrkari* ‘drier’ from *þurrka* ‘dry’, with the verbalizing *-ka* suffix, *stöðgari* ‘stabilizer’ from *stöðga* ‘stabilize’ with the verbalizing *-ga* suffix.<sup>25</sup> I will leave this issue for future research however.

The suffix *-andi* is the clearest case of an outer-attaching suffix derived from a verb. It is productive and based on the verbal root form, and its use generally entails the existence of a verb. One potential mystery associated with this suffix, however, is that it seems to be homophonous with a present participle whose use overlaps in some cases with progressive *-ing* in English (see Jóhannsdóttir 2005, 2007, 2011 for detailed discussion). As in many cases of apparent homophony, one may wonder if it really is homophony or if there is a genuine morphosyntactic relationship between the two. This morpheme is also used to derive ability adjectives and a kind of middle construction (H.Á. Sigurðsson, 1989; Wood & E.F. Sigurðsson, 2014).

Suffixes like *-ingi* and *-isti* resemble English suffixes like *-ist* and *-ant* (among others) in that they tend to be based on nominal or adjectival forms. The most common word for ‘murderer’, for example, is *morðingi*, apparently based on the nominal form *morð* rather than the verbal form *myrð-*. It is also possible to use *-andi*, according to Ingason & E.F. Sigurðsson (2015), in which case it is based on the verbal form, yielding *myrðandi*. However, we also see cases where it seems to be based on the verb morphologically, such as *banka-ræn-ingi* ‘bank robber’, based on the verbal form *ræn* rather than the nominal form *rán*. There are also forms like *blind-ingi* ‘blind person’, apparently based on the adjectival form *blind-*, *feit-ingi* ‘fat person’ based on the adjectival form *feit-* ‘fat’, and *aum-ingi* ‘wretch’, which may be based on the adjectival form *aum-* ‘wretched’. The suffix *-isti* is a borrowed form, and appears on many borrowed stems such as *húmanisti* ‘humanist’, but also appears on nominal forms like *dópisti* ‘drug addict, junkie’ and *grínisti* ‘fun-maker, joker’, from *dóp* ‘drugs’ and *grín* ‘joke’ (respectively). These are most likely root-derived, though it is possible that future research will reveal that they can be derived from a categorized noun or adjective.

The final form I will mention is compounds that are headed by *maður* ‘man’ or *kona* ‘woman’. This is a fairly common process in Icelandic, and like the other processes discussed in this section, deserves detailed study of its own. It frequently attaches to nouns, as in *lögmaður* ‘lawyer’ (lit. ‘law-man’), *blaðamaður* ‘journalist’ (lit. ‘paper-man’), *fréttamaður* ‘journalist’ (lit. ‘news-man’), *flugmaður* ‘pilot’ (lit. ‘flight-man’), *drykkjumaður* ‘drinker/drunken’ (lit. ‘drink/beverage-man’). Other categories, such as prepositions, are also possible, as in *yfirmaður* ‘supervisor’ (lit. ‘over-man’). Interestingly, many cases that might be expected to be derived from a verb are instead derived from an overtly nominalized verb. For example, *reykingamaður* ‘smoker’ is based on *reyk-ing-ar* ‘smoking’, derived with the nominal suffix *-ing* attaching to the verb (or verbal root of) *reykja* ‘smoke’. In the noun *afgreiðslumaður* ‘shop assistant/sales person’, which can also be *afgreiðslukona* when it refers to a person who identifies as female, the non-head of the compound is *afgreiðsla* ‘service’, with the overt nominalizer *-sla*, presumably built on the verb *afgreiða* ‘serve’ (as in ‘serve a customer’). Similarly, *björgunarmaður* ‘rescuer, life-saver’ is derived by compounding *maður* ‘man’ with *björg-un* ‘rescue’ with overt nominalizer *-un*, presumably built from the verb *bjarga* ‘rescue’. Some other cases are possibly derived from verb stems, although there is no overt verbalizer. The noun *leikmaður* ‘player (in sports)’ is built on the root used in the verb *leika* ‘play’, and *ökumaður* ‘driver’ is clearly based on the same root as the verb *aka* ‘drive’.

Turning to the structure and interpretation of agent nominals, I would like to propose broadly that agent nominals are built in two steps. First there is a nominalizer responsible for turning the verb into a noun. Second, it is a higher head that introduces the actual agentive interpretation that the noun refers to. To implement this, I will assume that in the first, nominalization stage, the verb is nominalized with a syntactically distinct n head, which I will refer to as

<sup>25</sup> I have come across no cases of *-ari* nouns derived from *-væða* verbs, however.



$n_A$ . Like the  $n$  we have seen elsewhere,  $n_A$  can be semantically null or have its own meaning. However, when it is semantically null, it triggers a special interpretation of the Poss head directly above it, along the lines shown in (67).<sup>26</sup>

(65) **Agent Nominal Analysis 1**

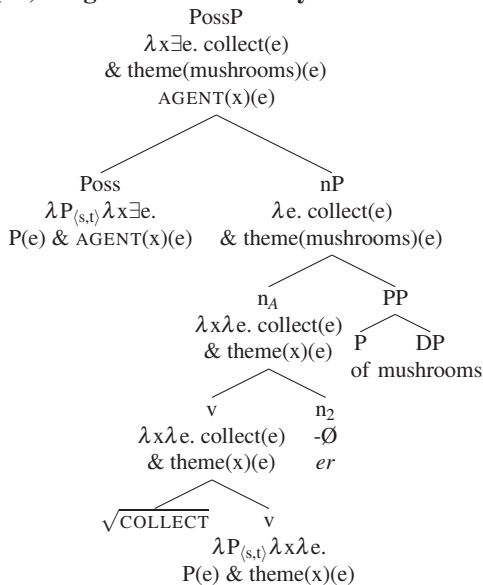

When Poss combines with (an nP headed by) the ordinary eventive  $n$  head with a CEN meaning, it may introduce an agent role that is saturated by a DP in its specifier. What is special about the “agentive”  $n_A$  head is not that it allows Poss to introduce an agent role, but that the agent role in this case points to the denotation of the whole noun phrase; that is, rather than point to an event that has an agent, it points to the agent.

One advantage to this analysis is that up to the nP level, agent nouns and event nouns are built the same way, and function the same way in the building of phrases and compounds. Support for this view comes from facts discussed recently by Lieber (2017) (see also McIntyre 2014), namely that in addition to the well-discussed agent and instrument readings of English *-er* (which correspond to external argument theta-roles), *-er* nominals can refer to an animate patient (66a), inanimate patient (66b), location (66c), measure (66d), or inhabitant (66e).

- (66) a. I didn’t have to think twice about this bear. It was a shooter.  
 b. Dean was in the shower, but he agreed to meet us at the dealership to get us a loaner.  
 c. Powell left the diner with the kids before they even ate.  
 d. All right, let’s say it was a bigger turkey, let’s say you had a 20-pounder, just kind of go with...  
 e. Now 53, he considers himself a naturalized New Yorker.

(Lieber, 2017, 67)

This range of meanings suggests that the agentive meaning of agent nominals should not be directly associated with the  $n$  head realized as *-er*. Here, it is associated with that meaning indirectly, by allowing Poss to introduce agentive semantics in a different way. The cases in (66) involve non-null allosemes of  $n_A$ ; morphologically identical on the PF side, but semantically distinct on the LF side.

One potential problem with this implementation is that it does not leave Poss available to introduce the semantics of a genuine possessor, although its specifier is in principle available to host a DP syntactically.<sup>27</sup> An alternative implementation that would stay true to the analysis of agent nominals being derived in two stages would be to say that the semantic work done by Poss above is done by another head, such as a second nominalizing head. Baker & Vinokurova

<sup>26</sup> The representation in (67) shows the event variable being bound by an existential operator. Alternatively, following Baker & Vinokurova (2009), it could be bound by a generic operator. The present discussion does not hinge on this distinction; what is important is that it is bound by something other than a lambda operator.

<sup>27</sup> If the possessive semantics is in some cases computed by rule, rather than by the denotation of the Poss head, then there is no problem. For now, I would like to remain open to the assumption that syntactic possessors are always integrated semantically via a denotation introduced by the Poss head, and therefore explore the alternative below.

(2009) associate the semantics of agent nominals directly with the nominalizing head, but assume that this head takes a phrasal VP complement, which I maintain is not an option for Icelandic nominalizations.<sup>28</sup> But if there were a second nominalizing head, it could work essentially as Baker & Vinokurova (2009) propose, but syntactically it attaches to an nP rather than a verb phrase.<sup>29</sup>

(67) **Agent Nominal Analysis 2**

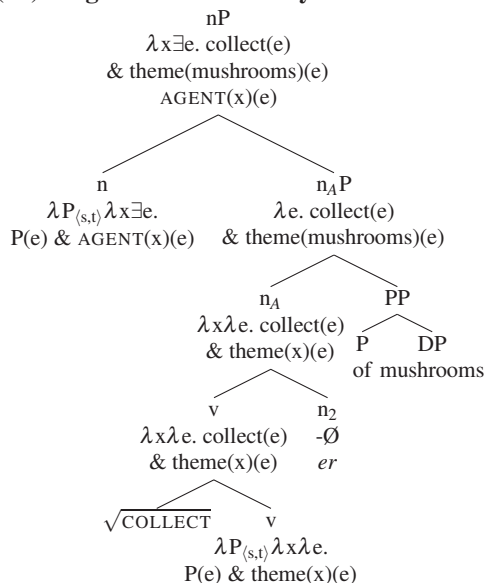

Indeed, Larson & Samiian (2021) propose that in general, nominalization involves not one nominalizer but two: a low nominalizer that is uninterpretable, which gets its categorial value from a higher nominalizer, which is interpretable. This fits nicely with the suggestion here, where the lower nominalizing head ( $n_A$ ) is semantically expletive, and it is a higher head (either Poss or the higher  $n$  head) that actually introduces the agent semantics.

Independent conceptual support for this idea might be derived from agent nominals formed by compounding. Recall from earlier that such cases typically involve noun-noun compounds. That is, the non-head is a noun, often a nominalized verb. For example, *björgunarmaður* ‘rescuer, life-saver’ is derived by compounding *maður* ‘man’ with *björg-un* ‘rescue’ with overt nominalizer *-un*, presumably built from the verb *bjarga* ‘rescue’. These would have the structure in (68).<sup>30</sup>

(68)

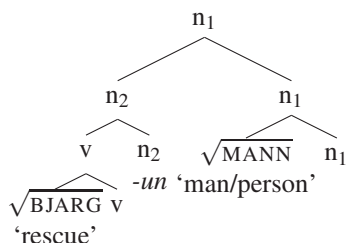

In this example, the nominalizing head  $n_2$  is semantically null, so the noun has the same meaning as the verb. That is, it is an eventive noun, *björgun* ‘rescue/rescuing’, not an agentive noun. The head of the compound, *maður* ‘man’ is

<sup>28</sup> If agent nominal semantics were associated directly with the nominalizing head in a complex head structure, before the object is introduced, it raises some complications for associating the object with the semantics of the verb past this head. If there is a theme predicate introduced by the verb, as shown in (67), then this could be done by assuming Function Composition, which is arguably independently needed (Wood 2015). This is essentially the solution proposed by Di Scullio & Williams (1987). But if verb phrase semantics are built without theme roles, as in the second kind of analysis that I develop in this book, then making it work with an agent nominal interpretation on the noun would involve revising the compositional mechanisms involved, and this goes beyond the scope of the present study.

<sup>29</sup> The same holds if the work of Poss is done by some other functional head, higher than  $n$  but lower than Poss, a possibility that I do not explore here.

<sup>30</sup> Actually, given that the genitive marker appears on the non-head, both the non-head and the head would be slightly larger according to Harðarson (2016, 2017); each would have a  $\phi$  head as well. This is immaterial to the present point, assuming that the  $\phi$  head is purely inflectional and is not interpreted semantically.

where the agentive meaning comes from. Examples like this show that semantically, it is quite sensible to assume that we build an agent nominal by first nominalizing the verb, without agentive meaning, and then combining that with another element that is responsible for the ‘agent’ semantics. Words like *björgunarmaður* ‘rescuer, life-saver’ wear this analysis on their morphological sleeve.

Moreover, we derive additional support from the observation that agent nominals that are derived by compounding, like *björgunarmaður* ‘rescuer, life-saver’, do not inherit the object argument from the underlying verb. Consider why. The structure in (68) requires computing some relation between the non-head and the head, so that the non-head modifies the head in some way.

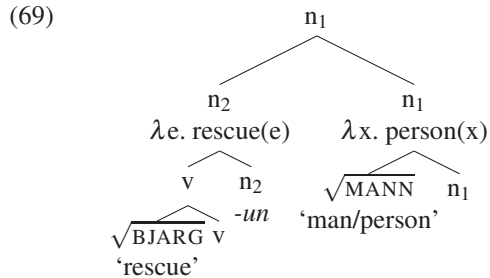

It is the ‘person associated with rescuing events’, in this case the agent of such events. If this kind of semantics “closes out” the eventive meaning of the verb, then one could not add a complement to the compound that denotes the theme; the eventive meaning required to compute the theme relation is inaccessible at that stage.

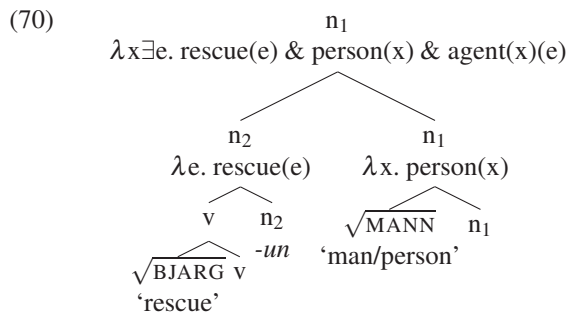

Instead, such a complement would have to be a complement of either the v head, which would form a vP, or the lower n head (realized in this case by *-un*), forming an nP.

(71) a. **Ill-formed Structure 1**

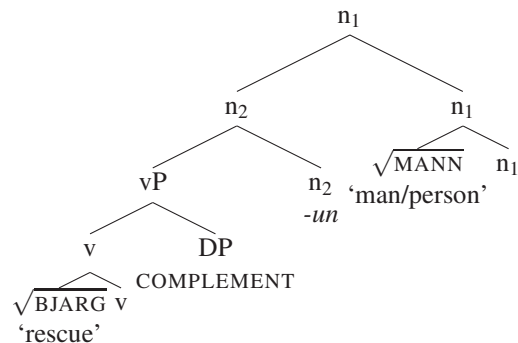

b. **Ill-formed Structure 2**

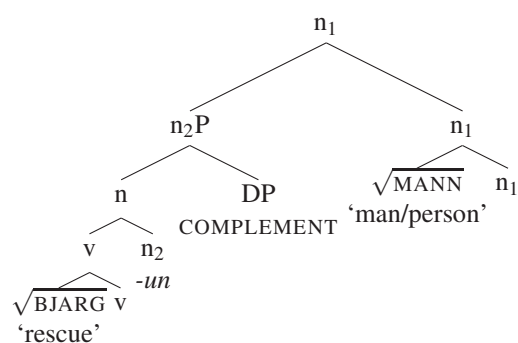

Neither of these options work, because neither will form the input to a compound of the relevant sort; phrases do not adjoin to heads. At best the result would be a phrasal compound, with *maður* ‘man’ as the head, and the whole vP or nP to its left (something like ‘a “saver of whales” man’).

However, the latter option is essentially what we have in cases of “true” agent nominals, that is, the ones derived not by compounding, but with a nominalizing head. Those cases are parallel in bracketing: something of category n—or Poss—combines with the nP, which crucially already has its complement, and denotes the agent.

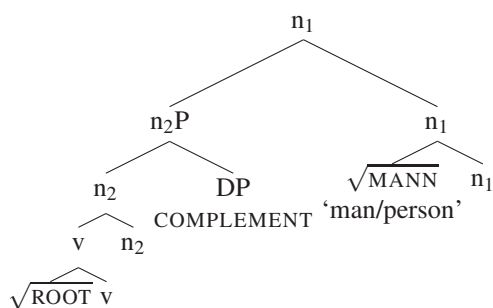
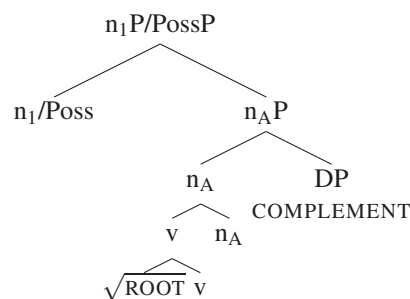
(72) a. **Ill-formed Structure 2**b. **Well-formed Structure**

The difference is that the agentive *n* is a rootless head, which takes the *nP* as a complement, and this is structurally just fine; there is no need to adjoin a phrase to a head. To put it another way, a deverbal *nP* with a theme complement can combine with a nominalizing head, to be its complement, but this *nP* cannot adjoin to another noun (at least not without forming a phrasal compound). All of this fits in nicely with the view that with agent nominals, the argument-taking properties of the verb are not projected past the semantics of the agent head, but must be saturated/satisfied before such a head is introduced. This is possible under complementation/affixation, but not under compounding.<sup>31</sup> If this approach to agent nominals is on the right track, then nothing special needs to be said about them in the context of the synthetic compounds discussed in the next subsection—the syntactic and semantic relationship between the head and the nonhead is the same, whether the nominalization ultimately refers to an agent or an event.

### 5.2.4 Synthetic Compounds

With a sketch of an understanding of agent nominals in place, I turn to the structure and interpretation of synthetic compounds. According to the present view, synthetic compounds are formed by adjoining the nonhead to the head, as in the structure in (73).<sup>32</sup>

(73)

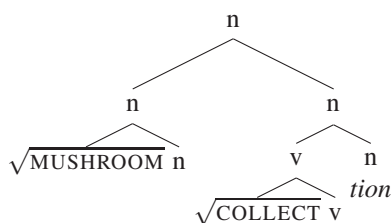

The structure in (73) is exactly parallel to the syntactic structure of primary compounds (in this work, as well as in Harðarson 2016, 2017, 2018; Ingason & E.F. Sigurðsson 2020).<sup>33</sup> Thus, I claim that any differences between synthetic compounds and primary compounds cannot, and need not, be accounted for by assuming that they are built in different ways.

Instead, I suggest that the difference involves the interpretation of the head. Agreeing with Alexiadou (2017b) and Iordăchioaia (2019a), synthetic compounds are headed by CENs. In the present work, this means that the verb gets its ordinary interpretation and the *n* head is semantically  $\emptyset$ . When another noun is adjoined to that noun, the

<sup>31</sup> Something like the theme could be introduced by making it the non-head of another compound, however, since any number of relations can be computed between a non-head and a head in compounding. I do not investigate this possibility here.

<sup>32</sup> Actually, what is entailed by the present proposal is only that the noun *mushroom* merges with the nominalized verb *collection*; one could in principle propose that *mushroom* projects an *nP*, merges as the complement of the noun *collection*, and forms a compound structure in some other way. I do not pursue this alternative here.

<sup>33</sup> For alternative analyses of primary compounds in a framework with similar assumptions to the present work, see Josefsson (1998, 2005), Zhang (2007), Harley (2009a), Jackson & Punske (2013), De Belder & van Koppen (2016), De Belder (2017), Eik (2019), Ntelitheos & Pertsova (2019), Steddy (2019), Nóbrega & Panagiotidis (2020) and Nóbrega (2020). See also Embick (2016) for relevant discussion.

resulting structure must be interpreted somehow. Semantically, it is as though the noun is adjoined to the verb, even though syntactically, nouns do not productively adjoin to verbs.<sup>34</sup> Building on the verb meaning developed earlier, and assuming that nonheads are nouns denoting properties, the interpretation of the two parts of the compound will be as indicated in (74) and (75) (for *house-painting* and *door-opening*, respectively).

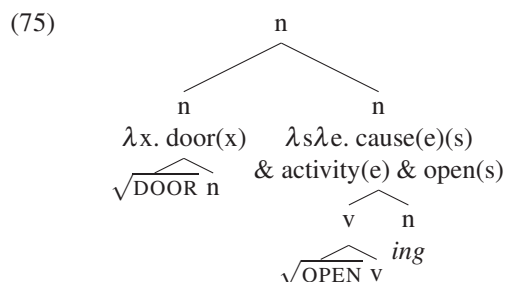
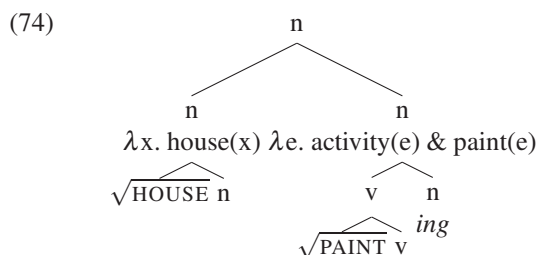

Notice that here, there is no simple composition rule that can put the nonhead and the head together. The nonhead denotes a property of type  $\langle e, t \rangle$  and the head denotes a function of type  $\langle s_e, t \rangle$  (in (74)) or  $\langle s_s, \langle s_e, t \rangle \rangle$  (in (75)). What we want is to recreate the verbal meaning, but without the correlates of meaning that correspond to the DP-internal structure, such as articles, other determiners, etc. Recall that DPs were assumed to be interpreted as states by a rule like (41), repeated here in (76).

$$(76) \quad \llbracket \text{DP} \rrbracket \rightarrow \text{STATE}(\llbracket \text{DP} \rrbracket) = (\lambda x \lambda s. \text{state}(s)(x))(\llbracket \text{DP} \rrbracket)$$

In this case, we will invoke a minimally different rule, which also introduces a state but along with existential closure over the entity variable of the nonhead. In fact, we already invoked this for the interpretation of roots like  $\sqrt{\text{PILE}}$  when they are adjoined to *v*. The rule is repeated here:

$$(77) \quad \llbracket X_{\langle e, t \rangle} \rrbracket \rightarrow \text{STATE}(\llbracket X_{\langle e, t \rangle} \rrbracket) = (\lambda P_{\langle e, t \rangle} \lambda s \exists x. \text{state}(s)(x) \ \& \ P(x))(\llbracket X_{\langle e, t \rangle} \rrbracket)$$

Once this is applied to the nonhead, composition proceeds in the same way as above. The root node in (74) will combine by the cause rule in (43) and the root node in (75) will combine by State Identification.

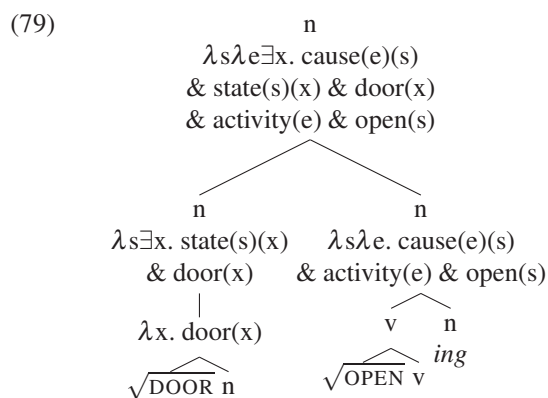
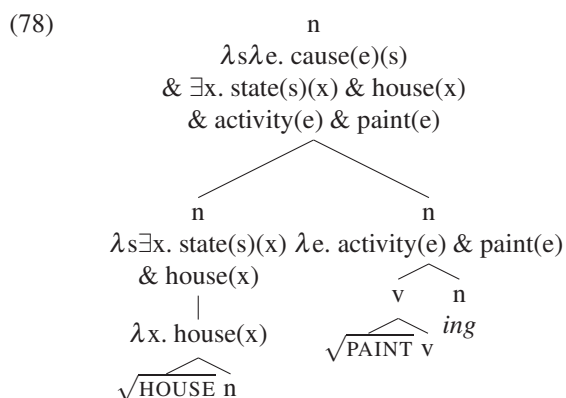

The same processes may apply in the case of entity roots like  $\sqrt{\text{PILE}}$ .

<sup>34</sup> This analysis captures the intuition that synthetic compounds in languages like English or Icelandic resemble incorporation structures in languages that do allow nouns to incorporate into verbs.



- (82)  $\# \lambda s \lambda e [\exists x. \text{cause}(e)(s) \ \& \ \text{state}(s)(x) \ \& \ \text{car}(x) \ \& \ \text{activity}(e) \ \& \ \text{open}(s)] \ \& \ [\exists y. \text{state}(s)(y) \ \& \ \text{door}(y)]$   
 $\approx$  ‘the set of states (of being open)  $s$  and activities  $e$  that cause a car and a door to be in state  $s$ ’

Since this meaning is, as far as I can tell, unavailable, I assume that existential closure applies to the state variable at the root node of any noun-noun compound. Thus, the state variable will not be available for further modification. The initial compound, in this case *car opening*, will denote a set of events, not a function from a set of states to a set of events. Once we assume this much, the structure in (81) will generate another kind of reading: since *door* would denote a set of states, and *car opening* would denote a set of events, the relation between them would be computed as one of causation (by the cause rule in (43)). The result would be a different infelicitous reading, shown in (83).

- (83)  $\# \lambda e \exists s' [\text{cause}(e)(s')] \ \& \ [\exists s [\text{cause}(e)(s) \ \& \ \text{activity}(e) \ \& \ \text{open}(s)] \ \& \ [\exists x. \text{state}(s)(x) \ \& \ \text{car}(x)]] \ \& \ [\exists x. \text{state}(s')(x) \ \& \ \text{door}(x)]$   
 $\approx$  ‘the set of activity events  $e$  that cause a car to be in an open state  $s$  and causes a door to be in a(n unspecified) state  $s'$ ’

Thus, this interpretation ends up with a new, separate state variable and a new, separate cause relation. But already, this is not a “multiple theme” interpretation: the root does not name the end-state of the higher non-head, the way it does for the lower head. The reading that this does generate is ill-formed for other reasons. In this interpretation, the same event variable functions as the argument of two separate cause relations with two distinct end-states. I assume for the time being that this is semantically ill-formed, in the same way that one event variable cannot have two separate agents (e.g. in passive by-phrases, where *\*She was run over by John by a car*). That is, there is a general ban, within a given argument structure domain, on multiple, distinct instances of the same relation with the same event variable but different entities.<sup>35</sup> In sum, this first difference between primary compounds and synthetic compounds falls out as a consequence of how synthetic compounds are interpreted: the “multiple theme” interpretation is ruled out, and the other possible interpretation is semantically ill-formed. What is possible is to interpret the higher level by any of the regular set of relations that characterize the interpretive relation between the constituents of primary compounds.

The second difference between primary and synthetic compounds that Harðarson (2018) points to is that synthetic compounds always have a phrasal counterpart. Next to *mushroom collection* is *collection of mushrooms*, for example. Primary compounds may sometimes have a phrasal counterpart (such as *nurse shoes* and *shoes off for nurses*), but not always. There is no phrasal counterpart to *daughter languages* or *motherland*. Some counterexamples to this claim have been discussed by Borer (2012), Alexiadou (2017b), and Iordăchioaia et al. (2017), such as *babysitter*. However, I agree with Alexiadou (2017b) and Iordăchioaia et al. (2017) that the counterexamples have a different analysis from productive synthetic compounds, such as a structure where the nonhead is a root adjoined to the root of the head. I take the general fact to be as Harðarson (2018) says it is.

This general difference follows from the analysis here. The reason that synthetic compounds have phrasal counterparts is that their heads are open event nominals, which have all the properties necessary to take a phrasal complement. When such a head combines with a nonhead in a compound structure, the nonhead builds on the same part of the meaning that a phrasal complement would. Primary compounds are different, in that the meaning is computed as some general relation between the two parts. That relation may be part of the set of relations that complements can express, but it need not. This is particularly so in the case of modifier-like nonheads, where most phrasal complements are not equipped to express the modifier-like meaning. A *daughter language* points to a kind of language, but the relation isn’t one of constitution or possession (as in *language of daughters*), or benefaction (as in *language for daughters*). This kind of modification is simply not among the sorts of relations expressed by the available phrasal structures (see Ingason & E.F. Sigurðsson 2020 for a recent proposal regarding the interpretation of these kinds of compounds).

The third difference that Harðarson (2018) points to is that synthetic compounds are always semantically predictable and compositional, whereas primary compounds are not always semantically predictable and compositional. This follows much in the same way as the second difference. On the one hand, they are not always compositional: *ice-breaker*, for example, has an idiomatic meaning; but it is the same that is found for the phrase, as in *break the ice*. Again, this follows from the fact that synthetic compounds are built on verbs with verbal meaning. Primary compounds need not be compositional either, but they also need not correspond to a possible phrase, as discussed above.

<sup>35</sup> Alternatively, or additionally, we could propose that a single state variable cannot apply to more than one entity. That is, there can generally only be one “state(s)(x)” predicate at a time. The exception would involve roots like  $\sqrt{\text{PILE}}$ , but they are arguably principled exceptions, since they point to the same entity in the model as the theme (the pile and the books are the same thing, it is a pile of books), where the entity root describes the current status or configuration of the theme (the books form a pile).

The present analysis thus treats synthetic compounds as CENs, and derives the differences between primary compounds and synthetic compounds on that basis. However, there are some ways in which synthetic compounds are different from canonical CENs. It has been observed that synthetic compounds differ from other CENs in that they cannot license aspectual adverbials, and lack the prior event entailment (Alexiadou & Schäfer, 2010; Alexiadou, 2017b).

(84) **Aspectual**

- a. the enemy's destruction of the city (in two hours)
- b. the enemy's city-destruction (\*in two hours)

(85) **Prior Event Entailment**

- a. a driver of trucks (must have driven a truck before)
- b. a truck-driver (might have just been hired, never driven a truck)

Icelandic has similar contrasts, as shown in (86) and (87).

(86) **Aspectual**

- a. eyðilegging borgarinnar (á tveimur tímum)  
destruction city.the.GEN (in two hours)  
'the destruction of the city in two hours'
- b. borgar-eyðilegging-in (\*á tveimur tímum)  
city.GEN-destruction-the (\*in two hours)  
'the city-destruction in two hours'

(87) **Prior Event Entailment**

- a. eyðileggj-andi borga  
destroy-NMLZ cities.GEN  
'destroyer of cities'  
→ must have destroyed a city before
- b. borgar-eyðileggj-andi  
city.GEN-destroy-NMLZ towns.GEN  
'city destroyer'  
→ could be job title; needn't have destroyed a city before

Alexiadou (2017b) analyzed these contrasts as showing that synthetic compounds lack the Asp head, above Voice, contained in other CENs. Since her explanation requires a phrasal layering analysis, it is not available here.

As for the prior event entailment, it is not clear that this is a general difference that needs to be encoded structurally. McIntyre (2014) shows that in general, synthetic compounds do entail the existence of a prior event. The cases where they do not entail such an event involve "functional" interpretations or dispositional interpretations. Functional interpretations "name entities whose intrinsic or designated purpose or function is to participate in the event named by the affixed V" (McIntyre, 2014, 123). With dispositional interpretations, the "referents have properties predisposing them for participation in particular events" (McIntyre, 2014, 123) (see also Alexiadou & Schäfer 2010; Roy & Soare 2013, 2014). Neither functional nor dispositional interpretations are eventive, so there is no entailment of a prior event. Lieber (2017, 161) makes the same kind of point, arguing that some synthetic compounds in fact do entail an event. For example, a *child murderer* must have murdered a child.<sup>36</sup> On the other hand, when non-compounds have a dispositional interpretation, they do not entail an event; Lieber cites an attested example of *dispenser of sanitizing towels* which has a clear dispositional meaning and no event entailment.

Thus, the apparent difference regarding the event entailment has to do not with the structural difference between phrases and compounds per se, but with the readings available to each. I suggest that in general, the compound structure is a better fit for functional and dispositional interpretations, so that there are many more salient examples that contrast with their phrasal counterparts. As discussed in detail in chapter 4, the adjunction structure used to form compounds creates a closer locality domain for the purposes of idiosyncratic interpretation than the phrasal structure does. Thus, the specialized interpretation of a compound will not necessarily be available in the phrasal counterpart, and the

<sup>36</sup> A parallel judgment holds for Icelandic *barnamorðingi* 'child murderer', according to Sigríður Sæunn Sigurðardóttir.



nature of the locality domain is such that specialized interpretations will arise quite easily over time.<sup>37</sup> Moreover, the compound structure involves less structure on the non-head than on its corresponding complement in the phrasal variant. This makes it less likely to be understood as referring to an actual entity or set of entities, making it a good fit for a dispositional or functional interpretation.

Turning to the aspectual difference, Alexiadou (2017b) connects this to the structural size of the theme argument, proposing that a larger theme argument will need to be licensed by an Asp head, whereas a smaller, nP sized argument, cannot be. I propose that the Asp head part of the story is not really necessary, but that the structural size of the theme does matter. When the theme is a DP, it is classified and individuated, allowing it to measure out the event. The noun, say, ‘destruction’, only denotes an event; the referential DP ‘the city’ measures out the time of the event by the extent of the city as the subevents of destruction apply to it. In a compound, the nonhead is just an n head, denoting a property (see McKenzie 2018; see also Harley 2010). It must be interpreted as acting as the theme, but it cannot measure out an event in time.

### 5.3 When and why are arguments obligatory?

Given what has been said so far, it is worth asking what it is that makes arguments obligatory. It seems to be a fact that nouns and verbs are just different in this way: verbs require arguments in a way that nouns do not. In a phrasal layering analysis, CENs require arguments because verbs in verb phrases do, and CENs contain verb phrases. So what, in the present system, makes arguments sometimes obligatory with the CEN reading with nouns?

The short answer is that the difference is ultimately not really about nouns versus verbs, even if it appears that way. In fact, this is something that has become apparent in phrasal layering systems as well. Bruening (2018b) argues for a phrasal layering analysis, but rejects the claim that arguments are obligatory with CENs in the first place. He ends up with a stipulation to the effect that the nominalizing head makes the argument of the verb optionally implicit (see section 2.3.1 for discussion). But if that is so, then the apparent obligatory argumenthood of CENs does not follow from the structure in the first place. Harley (2009b) and Alexiadou (2009) also adopt a phrasal layering system, and come to the conclusion that even Result Nominals must be able to contain a categorized verb heading a vP—even though arguments are not obligatory with RNs. They must then come up with an alternative explanation for why arguments are sometimes obligatory. Harley (2009b), for example, proposes that CENs are like mass nouns, and that they need an argument to measure out the event. This is not necessary for RNs and SENs, which are like count nouns, since the nominal “count” structure can measure out the event. But once again, if this account is correct, then having an obligatory argument is not about containing a verb or vP in the structure; it is about something else.

The explanation in my system is also that it is not truly about containing a vP or not, or containing a verb or not. It is about whether the semantic representation being built requires an argument or not. The gist of the explanation in the present system is that when the noun is semantically zero, and thus inherits the meaning of the verb, it requires an argument to the same extent that the verb does.<sup>38</sup> This intuition should transcend distinct technical implementations of the semantic analysis in order to be in line with the basic spirit of what I am proposing.

At a more technical level, there are two ways of deriving this, corresponding to the simple and the more complex implementation of inheritance discussed in this chapter. In version 1, the “theme” predicate is only introduced by v, and related to a proper “event” variable of type s. When it is introduced, it must be saturated, and this holds true with deverbal nouns and verbs. In version 2, object arguments are part of event construction (through the interpretive mechanisms outlined in section 5.2). Without them, there simply is not a complex event reading. So when we add modifiers that are sensitive to that meaning (such as telicity PPs), they do not work unless there is an object that functions to build to the appropriate meaning in the first place.

In both versions, it is something about the semantics of verbs—either the predicates they introduce (e.g. “THEME”) or the kind of event variable they introduce, or both. But this is certainly no worse the stipulation that verbs are different from nouns syntactically, and as I have emphasized above, even some phrasal layering analyses have made

<sup>37</sup> For example, in the interpretation of *coffee-maker*, the structure is such that the roots  $\sqrt{\text{COFFEE}}$  and  $\sqrt{\text{MAKE}}$  will be in the same local domain for interpretive purposes, and the n head will be sensitive to both of them at the same time. Thus, any idiosyncratically determined meaning pointing to a particular, conventionalized machine, is easy to compute. But in the interpretation of *maker of coffee*, the structure is such that the roots  $\sqrt{\text{COFFEE}}$  and  $\sqrt{\text{MAKE}}$  will be spelled out separately, so n cannot be sensitive to them both at the same time, making a conventionalized functional reading much less likely.

<sup>38</sup> There are deviations from this basic scenario, which then require an independent explanation. See section 2.3.1 for discussion.

it clear that it is not the syntactic presence of a verb or verb phrase that makes arguments obligatory. The present account is therefore not at any kind of disadvantage in accounting for the distribution of arguments. In fact, it may be that it is the phrasal layering analyses at a disadvantage here, because they require some amount of look-ahead to make vP arguments that are (sometimes, or at least in principle) *obligatory* in the *absence* of nominal structure become *optional* in the *presence* of such structure. In the present account, the verb is nominalized before any arguments appear anyway, which at least opens up the possibility that the nominal structure may “interfere” with an otherwise obligatory argument without any kind of look-ahead.

## 5.4 Summary

In this chapter, I have spelled out the essentials of how a system that embraces allosemy accounts for the facts of nominalization. The basic idea is that one structure can get multiple structural interpretations, because its terminal nodes are compatible with multiple allosemes. After spelling out this basic idea, I discussed in some detail how internal arguments are inherited (or not), how external arguments are computed from the result, and how synthetic compounds are integrated into the system. I abandoned the assumption that verbs take direct arguments mediated by a theme relation, and discussed how event structure could be built dynamically in the nP the way that it has been argued to do so in the vP. Some of the complexity from the allosemes themselves is shifted to the compositional processes that are assumed to take place. This shift includes an explanation of cases where only an *á*-PP or genitive were possible, and a distinct analysis of synthetic compounds (and compounds in general).

## Chapter 6

# Simple Event Nominals, Referring Nominals and Allosemy

This chapter discusses the Simple Event Nominals and Referring Nominals in the context of the theory of allosemy. The basic claim here is that such nominals are built with a semantically contentful *n*, whether *v* is semantically contentful or semantically  $\emptyset$  (modeled as an identity function). When *v* is semantically contentful, the meaning of the nominal must be built on the meaning of the verb, just like CENs discussed in the previous chapter (except with the extra meaning contributed by *n*), and the root and *n* cannot interact directly with each other; this is schematized in (1). When the *v* head is  $\emptyset$ , the *n* head combines directly with the root, semantically, and they can interact with each other; this is schematized in (2), where the insertion of a null alloseme of *v* is followed by pruning of that node.

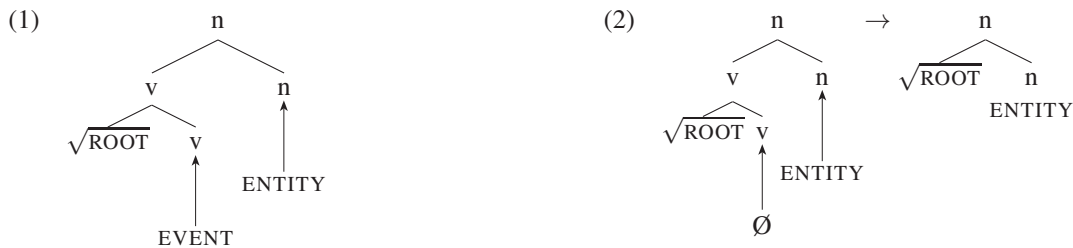

In (2), where the alloseme selected by the *n* head can interact directly with the meaning of the root, the result can look like systematic polysemy or even arbitrary idiomaticity. However, I will propose that there are systematic limits on the nature of this interaction: the root can condition the insertion of a specific (“suppletive”) alloseme of *n*, and *n* can condition certain “readjustments” to the root. This interaction is parallel to the locality conditions on the morphological side: *n* can get a root-determined allomorph when *v* is morphologically null, so that *n* combines directly with the root phonologically; in turn, *n* can condition morphological readjustment to the root. Along the way, I discuss in some detail the issue of how to distinguish a distinct alloseme of *n* from ‘semantic readjustment’ of a root in the context of a particular alloseme. For example, an event can lead to the creation of a concrete entity or an abstract state. Does this distinction correspond to distinct allosemes of *n*, or does it follow from how we understand the notion of ‘result’ in the context of a particular root? I argue that there are several allosemes of *n* used in deverbal nominalizations, but perhaps not as many as one might have expected.

As I did in the previous chapter, I would like to make it clear at the outset what the core claims of this chapter are, to distinguish them from the specific formal implementation of these claims that is presented below. I pointed out there that this book is primarily a theory of the interface between syntax and semantics (and morphology), not a theory of lexical semantics in and of itself. In this chapter, I discuss at some length the question of what aspects of meaning should be encoded as an alloseme of *n* and what should be part of the resolution of a root in the context of a particular meaning. What I am proposing has to do with how such issues are approached, and what the predicted interactions between components of meaning are. Specifically:

- RNs and SENs are not always built off of the meaning of the verb, and may involve negotiation of the root with the meaning of *n*.
- RNs and SENs (unlike CENs) allow some interaction between the root and *n*, but only if (and when) *v* is semantically  $\emptyset$ .

- Claims about the range of alloemes of *n* in deverbal contexts must be based on cases where *v* is phonologically overt (or we have some other reason to be sure that *v* is present), to be sure that we are not dealing with root-attached *n*.
- Roots may condition a particular alloeme of *n*; idiosyncratic alloemes of the roots, however, can generally be understood as ‘semantic readjustment’, modifying the meaning of the root to fit the meaning of *n*.
- Event-related prefixes can diagnose layers of meaning inside the complex head of nominalizations, in cases where phrasal modifiers cannot.
- The eventive meaning of SENs is distinct from the eventive meaning of CENs.

I do not fully resolve the issue of how many alloemes of *n* are needed, or whether ‘concrete’ vs. ‘abstract’ needs to be encoded in the semantics. However, I do offer a proposal for how to approach the issue: a separate alloeme is needed for a meaning only if the meaning in question is picked out as root-specific allosemy in a way that is not reducible to that root’s inherent lexical semantics.

### 6.1 The locality of allomorphy

In thinking about the locality of allosemy, it is worth beginning by considering the locality of allomorphy. The default assumption is that the upper bound for locality should be the same at both LF and PF, given that the point of spellout will determine the size of the structure sent to the interfaces. Locality constraints can be smaller than this, but they cannot be larger than this. For example, Embick (2010) argues that for *X* to condition a special, suppletive allomorph on *Y*, *X* and *Y* must have no more than one phase head intervening between them, and they must be phonologically adjacent. If they meet the phase requirement, but have an overt morpheme between them, they do not meet the conditions for conditioned allomorphy. It is important to consider this point carefully, because it bears on what we consider to be the “same” upper bound at PF and LF. Consider the following structure, and assume that *X*, *Y*, and *Z* are all local as far as the phasehood requirement is concerned.

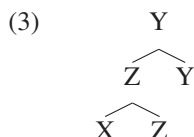

Since they are all phase-local, *X* could in principle condition a special allomorph or alloeme on *Y*, past *Z*. However, if *Z* gets an overt realization in the morphology, then *X* could not condition a special allomorph on *Y*, but it could still condition a special alloeme on *Y*, as long as *Y* does not get an “overt realization” (i.e., any meaning other than an identity function) in the semantics. This is schematized in (4).

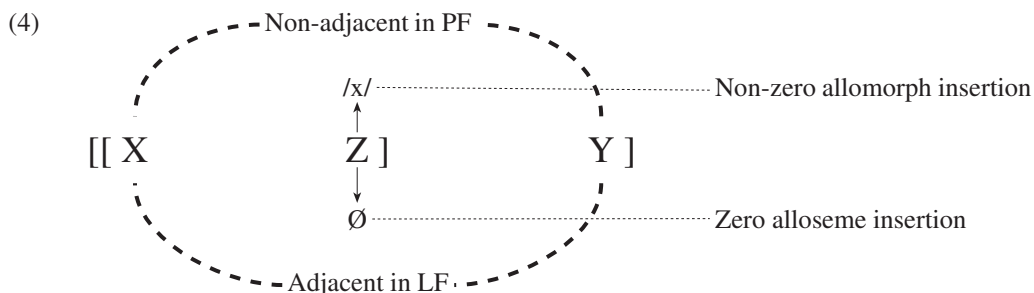

In this circumstance, the morphology would make *Z* appear to intervene structurally between *X* and *Y*, but *X* and *Y* could still condition special, idiosyncratic alloemes on one another, since *Z* does not intervene semantically between them. This is the configuration that I propose is at work in idiosyncratic “simple entity/event/state” nominalizations with an overt *v* head (where *X* is the root, *Y* is *n*, and *Z* is *v*).

Conversely, if *Z* gets an “overt” realization in the semantics (some meaningful denotation), then *X* would not be able to condition special meaning on *Y* past *Z*, but it could still condition a special allomorph on *Z* in the morphology, as long as *Y* does not get an overt realization in the morphology. This is schematized in the diagram in (5).

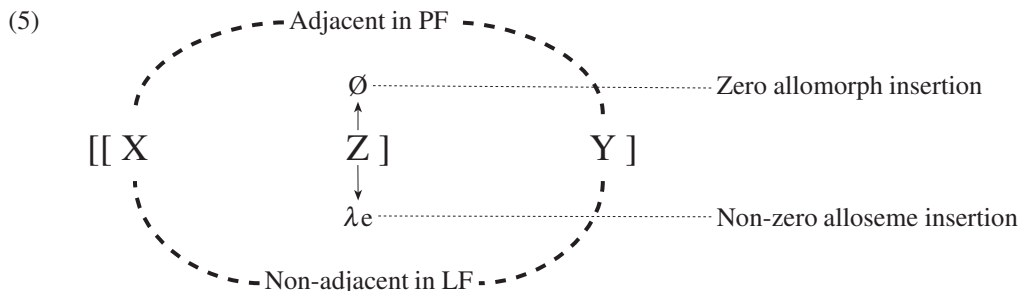

In this circumstance, the morphology would make X and Y appear to be adjacent, but X and Y cannot condition special idiosyncratic meanings on one another, because semantically, Z intervenes between the two. As I discuss below, this is the configuration that I propose is at work in Complex Event Nominalizations with a zero v head (where once again X is the root, Y is n, and Z is v).

Of course, it is also possible for Z to be zero at both PF and LF, or overt at both PF and LF. But these apparent mismatches illustrate what it means to say that the same upper bound on locality should apply at both LF and PF, but that the locality domains in practice may be smaller. These configurations make it look as though LF and PF have different sized locality domains, even though the phase-based “upper bound”—and even the nature of the basic locality constraints—is the same.

Before turning to nominalizations, I would like to illustrate the basic idea with one fairly clear case of a mismatch that may be analyzed along these lines. We know that the identity of a lexical root can condition special allomorphs of T, past little v (here ignoring other heads, such as Voice and Asp), and that T can condition morphological adjustments to the root (e.g. *saw* as the past tense of *see*).

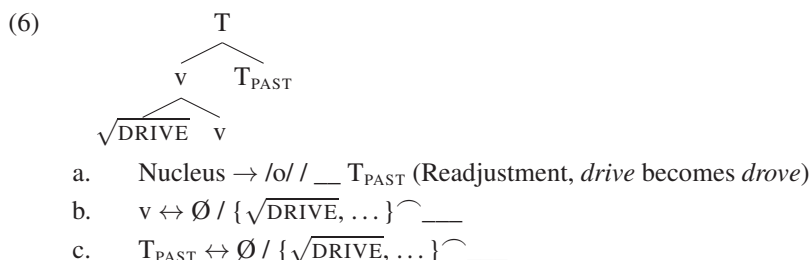

However, the root cannot, as far as we know, condition special tense semantics, nor can certain tenses condition special, idiosyncratic meanings of the root. It is not the case, for example, that a root like  $\sqrt{\text{DRIVE}}$  can mean something different in the past tense from what it means in the infinitive or present tense. This would be the case if *I drove* could mean ‘I fell down’, but *I drive* or *I want to drive* could not mean ‘I fall down’ or ‘I want to fall down’, respectively.

Thus, there is a mismatch. But it is easily explained, if we adopt the assumption that in order for T to be semantically interpreted, v must get an overt interpretation (introducing the event variable). If v gets an overt interpretation, then the root cannot interact in an idiosyncratic way with T, past v.

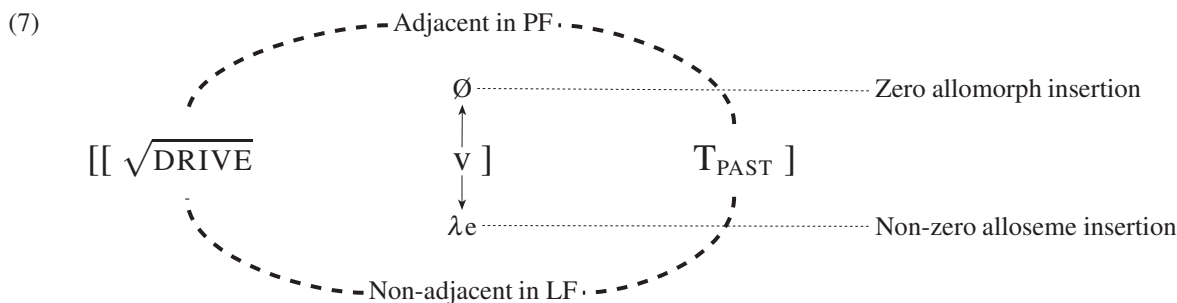

Therefore, the root will not get special meaning from past vs. present T, and the root will not condition special tense semantics on T.<sup>1</sup>

<sup>1</sup> One might wonder why the root could not simply become a predicate of events when it combines with T. It is worth pointing out here that the root-v complex will combine with a DP first, such as an object and/or a subject in SpecVoiceP. So one way or another, the root will

Turning to nominalizations, it would appear that different roots trigger different allomorphs of *n*. In English, we see *attain-ment* and not *\*attain-al*, but *removal* and not *\*removement*. However, we have reason to think that little *v* is, or at least can be present in both *attainment* and *removal*, since they can form CENs.

- (8) a. Guðrún's attainment of her goals in just two minutes  
 b. Guðrún's removal of the vehicle in just two minutes

As we discussed earlier, Borer's Generalization is that CENs are only possible with nouns that are derived morphologically from existing verbs. Our account of this is that CENs require a *v* head, and more specifically the kind of eventive meaning that a *v* head can contribute. This means that there must be a *v* head in *attainment* and *removal*.

- (9) a.  b. 

This in turn suggests that the morphological realization of *n* can be dependent on the identity of the root, past an intervening *v* head, provided that the *v* head is itself morphologically  $\emptyset$ .<sup>2</sup> This is nevertheless consistent with the claim that *v* and *n* are both phase heads that serve as boundary points for locality. All that is needed is that the information retained at the point of Vocabulary Insertion includes the lexical identity of the root.

Regardless of how it is executed technically, it seems that we have to conclude that the realization of *n* can be conditioned by the root, past *v*. What about the other way round? Certainly, nominalizing affixes can trigger phonological readjustments on the roots they combine with. For example, when *transmit* combines with *-tion* (as in *Guðrún's transmission of the message in just two minutes*), the */t/* at the end of *transmit* is either changed to */ʃ/* or it is deleted. The alternation between *destroy* and *destruct-* is directly sensitive to the presence or absence of the nominalizing affix. We have seen numerous cases in Icelandic where the vowel in a root is changed or conditioned on the basis of being nominalized, such as *myrð-* 'murder' (IPA = [mɪrð]) for the verb, and *morð-* 'murder' (IPA = [mɔrð]) for the noun (see discussion in sections 2.1 and 2.2.3). However, it is not clear that a nominalizer can trigger full root suppletion. If it did, then we probably would not have detected Borer's Generalization in the first place (see section 5.1.5 for discussion). Still, we know that at least the interaction between the affix and the root can modify the phonology of the root.

## 6.2 Contextually-conditioned allosemy in the three basic readings

We now turn to the locality of allosemy, first focusing on the three basic readings (RN, SEN, and CEN). The presentation above provided various denotations of *v* and *n* heads. It is proposed that either *v* or *n* can be semantically zero, and that this is a general option for functional heads, certainly for argument introducing heads, that may not need to be stipulated. Beyond that, *v* has its eventive meaning, and *n* has at least a simple event and simple entity meaning.<sup>3</sup> As far as has been shown so far, there are no restrictions on when each can be used: every combination of the different allosemes of *v* and *n* is possible, as long as the result is semantically interpretable.

However, it is actually not true that all options are always available. Just as allomorphy can be contextual, so that different suppletive allomorphs of *n* are available with different roots, so too is allosemy contextual. The existence of a zero alloseme of *v* may be a general fact, but that doesn't mean that this alloseme can occur with all roots. The existence of simple event and entity allosemes of *n* may be a general part of the system, but that does not mean that they may occur with all roots.<sup>4</sup>

have to get an interpretation at a lower level than T, so it will never combine directly with T semantically, even if it can combine directly with T morphologically.

<sup>2</sup> See, however, Embick (2016) for an alternative approach, where the exponents of *n* are not conditioned allomorphs, but are essentially in free variation, as far as the grammar is concerned. Embick, however, applies this to root-attached categorizers, not outer categorizers.

<sup>3</sup> See the next subsection for an elaboration on the range of simple event and entity meanings.

<sup>4</sup> See Melloni (2010, 144) for discussion of this point. Melloni (2010) argues that much of the variation in terms of available readings is predictable from the meaning of the basic verb or verb root; this issue is addressed in below in section 6.3.

For example, *attainment* seems to allow primarily a CEN reading, as in (10a). It cannot be used without arguments to describe an event of attaining something (the SEN reading), as illustrated in (10b). It also cannot be used to describe a concrete entity somehow related to an attaining event, such as an entity created by such an event or a theme that undergoes such an event, as illustrated in (10c).<sup>5</sup>

- (10) a. Guðrún's attainment of her goals in only two days was quite impressive.  
 b. \* The attainment lasted from Tuesday to Thursday.  
 c. \* Guðrún handed me the attainment.

It does appear in some contexts without arguments. For example, one can find many examples of a compound like *attainment gap*, and *attainment* can sometimes be used to refer to a state.

- (11) a. The attainment gap associated with socio-economic status is an international problem that is highly resistant to change.<sup>6</sup>  
 b. It is this thought of attainment that prevents, for as long as a meditator is able to sustain it, the arising of any other thoughts.<sup>7</sup>

It is possible that these are subtypes of RN readings, referring to abstract states that result from an event of attaining; see discussion in the next subsection. However, there is still a sharp difference between *attainment* and *achievement*:

- (12) a. That was a really impressive { achievement / ?? attainment }.  
 b. She displayed her { achievements / ?? attainments } on her wall.  
 c. I stacked my { achievements / ?? attainments } next to hers and fell short.

It seems quite plausible that there are idiosyncratic restrictions on the uses of *attainment* that do not follow automatically from the eventive meaning of the verb *attain*. These differences can be understood as the conditioning of distinct allosemes of *n* by the roots  $\sqrt{\text{ACHIEVE}}$  and  $\sqrt{\text{ATTAIN}}$ .<sup>8</sup>

We find similar cases in Icelandic. For example, *aðdáun* 'admiration' allows a complex event reading, as shown in (13a). It allows either a simple event or state reading, as shown in (13b). However, it does not seem to allow a concrete entity reading, as shown in (13c).<sup>9</sup>

- (13) a. Að-dá-un Guðrúnar á Maríu í öll þessi ár truflaði fólkið í kringum hana.  
 to-admire-NMLZ Guðrún.GEN on María for all these years bothered people.the around her  
 'Guðrún's admiration of María for all these years bothered the people around her.'  
 b. Að-dá-un-in stóð í mörg ár.  
 to-admire-NMLZ-the stood for many years  
 'The admiration lasted for many years.'  
 c. \* Guðrún { rétti mér / snerti } að-dá-un-ina.  
 Guðrún { handed me.DAT / touched } to-admire-NMLZ-the.ACC  
 INTENDED: 'Guðrún { handed me / touched } the admiration.'

<sup>5</sup> In this section, I will assume a relatively narrow understanding of an RN reading, where it refers to a concrete entity that one can touch ([+material] in the sense of Lieber 2017). This makes the exposition clearer, but it is a simplification that may ultimately affect the claim here, so it is discussed further below.

<sup>6</sup> <https://www.tandfonline.com/doi/abs/10.1080/02680939.2017.1352033>

<sup>7</sup> <https://plato.stanford.edu/entries/mind-indian-buddhism/>

<sup>8</sup> For the present discussion, I once again treat these as though they are simplex roots, even if they are in fact morphologically complex.

<sup>9</sup> Since 'admire' is a stative verb, it can be difficult to tell if the simple event reading is a simple event or a state reading. Note, however, that as an (at best) unbounded event, it resists pluralization. Compare (i) to the example with *viðvaranirnar* 'the warnings' in (14c).

- (i) ?\* Að-dá-an-ir-nar héldu áfram í mörg ár.  
 to-admire-NMLZ-PL-the held on for many years  
 INTENDED: 'The admirations continued for many years.'

*Viðvörðun* ‘warning’ can have a CEN reading, as in (14a), an SEN reading, as in (14b,c), or a concrete RN reading, as in (14d,e).<sup>10</sup>

- (14) a. { stöðug / endurtekin } við-vör-un Guðrúnar á hættunni (í tíu ár)  
 { constant / repeated } with-warn-NMLZ Guðrún.GEN on danger.the.DAT (for ten years)  
 ‘Guðrún’s { constant/repeated } warning of the danger (for ten years)’
- b. Við-vör-un-in stóð í mörg ár.  
 with-warn-NMLZ-the stood in many years  
 ‘The warning lasted for many years.’
- c. Við-var-an-ir-nar héldu áfram í mörg ár.  
 with-warn-NMLZ-PL-the held on for many years  
 ‘The warnings continued for many years.’
- d. Ég snerti við-vör-un-ina.  
 I touched with-warn-NMLZ-the  
 ‘I touched the warning.’
- e. Hún rétti mér við-vör-un-ina; hún var krumpuð.  
 she passed me with-warn-NMLZ-the it was crumpled  
 ‘She passed me the warning; it was crumpled.’

Some (but not all) speakers find the CEN reading of *þrælkun* ‘enslavement/slavery’ highly degraded, as shown in (15a). *Þrælkun* ‘enslavement/slavery’ can have a state or SEN reading, as shown in (15b), but not a concrete RN reading, as shown in (15c).

- (15) a. % Þræl-k-un hans á Guðrúnu stóð í mörg ár.  
 slave-VBLZ-NMLZ his on Guðrúnu stood for many years  
 INTENDED: ‘His enslavement of Guðrún lasted for many years.’
- b. Þetta er algjör þræl-k-un.  
 this is total slave-VBLZ-NMLZ  
 ‘This is total slavery.’
- c. \*Ég snerti þræl-k-un-ina.  
 I touched slave-VBLZ-NMLZ-the  
 ‘I touched the slavery/enslavement.’

The restrictions on the range of readings available to different roots suggest that the allosemes of *n* given above may come with contextual specifications, as illustrated schematically in (16).

- (16) a.  $\llbracket n \rrbracket \leftrightarrow \lambda P_{(e,t)} \lambda x \exists e. P(x) \ \& \ x = e / \_ \{ \sqrt{\text{ROOT}_1}, \sqrt{\text{ROOT}_2}, \dots, \sqrt{\text{ROOT}_n} \}$  (SEN)
- b.  $\llbracket n \rrbracket \leftrightarrow \lambda P_{(e,t)} \lambda x. P(x) / \_ \{ \sqrt{\text{ROOT}_1}, \sqrt{\text{ROOT}_4}, \dots, \sqrt{\text{ROOT}_n} \}$  (RN)

However, just as it is relatively easy for speakers to learn new nouns—our root list, and the contexts roots may appear in, is ever growing—it is easy to imagine how a verbal root not generally associated with an SEN or RN reading could get one. For example, suppose I start a new job, and my boss tells me that every Monday, I have to go to the main office to gather a packet of paper slips corresponding to all the materials that the company has attained over the weekend. The boss could then tell me that the slips of paper are referred to as attainments, and my job is to take all the attainments and distribute them to the appropriate division supervisors. In this scenario, learning the new use of *attainment* (adding it to the list of some alloseme of *n*) is easy and immediate. The grammatical system I possess is built to handle it automatically.

Thus, although allosemy is like allomorphy in that it can be contextually restricted, the general system has a range of semantic options built on a particular structure. Lexical roots are free to be compatible or incompatible with different options, but this is the flexible part of the system, which can bend under certain semantic pressures, and can be adapted to new contexts. The general system, however remains fixed: there is a finite number of allosemes for *v* and *n*, with

<sup>10</sup> Some speakers find (14b) somewhat marked. But most find it acceptable under some reading. For some, what came most readily to mind is a weather context, where the warning referred to some weather conditions. The most salient reading here seems to be a state reading: the warning refers to a state that holds for some period of time. (14c), however, has a clear SEN reading.



specific structural meanings. In most of the discussion in this work, I develop the discussion with the assumption that all options are available, unless otherwise specified. First, however, I turn to a discussion of the range of meanings found on RNs, and what they tell us about the locality of allosemy.

### 6.3 The locality of allosemy: RNs and idiosyncratic meaning

Earlier, we established that as long as *v* is phonologically  $\emptyset$ , the allomorph realizing *n* can be conditioned by the root, and in turn can trigger phonological readjustments on the root. Moreover, we have seen that the different basic readings of *n* can vary according to the lexical root. We now turn to the question of more idiosyncratic meanings conditioned between the root and *n*, past *v*. We will see here various cases suggesting that the specific semantic contribution of the root may be adjusted on the basis of the *n* it combines with semantically. For example, the RN reading of *examination* involves picking out a particular aspect of the root  $\sqrt{\text{EXAM}}$ , related to the object used to administer an exam (or the content it contains). I would suggest that this is a kind of semantic readjustment of the root—its basic properties and form remain and are recognizable, but its specific semantics are adjusted in the context of a particular alloseme of *n*.

Returning to the range of allosemes we find on *n*, there are certainly more than what I have already given, which is a null alloseme, a simple event alloseme and a simple entity alloseme. At the very least, there is also a state alloseme, a reading that has been emphasized in recent work on German (Roßdeutscher & Kamp, 2010; Pross, 2019). However, even beyond this, it has been noted in the literature that there are many possible readings of apparently deverbal nouns beyond the complex event and even the simple event readings. Although it has been common to talk about concrete nominals as ‘result’ nouns, Lieber (2017) points out such nouns can be agents, instruments, locations, results, products, and inanimate patients. Agents include examples like *government*, which refers to the body that is the agent of governing, or *administration*, which refers to the people who do the administering. Instruments include *decoration* and *adornment*, which refer to the things that are used to decorate and adorn things, respectively. Locations include *residence* and *reservation*, which refer to a place where people reside and a place reserved for people to reside, respectively.<sup>11</sup> Results, in Lieber’s terminology, refer primarily to the state attained after an event, such as *acceptance*, which can refer to the state attained after being accepted.<sup>12</sup> Products refer to things created from an event, such as *concoction* and *embroidery*, which can refer to entities that came into existence through a concocting or embroidering event. Inanimate patient readings refer to entities that are understood as the objects of some event denoted by the verb, including *discovery*, which can refer to a thing discovered (but whose existence does not result from a discovering event), and *assignment*, which can refer to a thing assigned (or intended to be assigned). The RN reading of *examination* also seems to be an inanimate patient RN.

In Icelandic, we find much the same picture. *Fjarstýring*, from *fjarstýra* ‘control from a distance’, can refer to a remote control (such as for a television), a clear instrument reading. But there are also cases where instrument readings are not possible, and other means, such as compounds, are used. The compound *uppþvotta-vél* ‘up-washing-machine’ is used for ‘dishwasher’; *þvottur* ‘washing’ or even *upþvottur* ‘up-washing’ does not mean this on its own. The compound *greiðslu-vél* is used for ‘payment machine’; *greiðsla* ‘payment’ does not mean this on its own. Alternatively, agent nominal affixes are used for instrument readings, much as in English, such as with *kortalesari* ‘card reader’, with the agent nominalizing suffix *-ari*, for the machine that takes the customer’s credit card at the gas station. The event nominal *lestur* ‘reading’ cannot have this meaning on its own. Similarly, some nominalizations of verb roots can be used for locations. *Bílageymsla* ‘car-store-NMLZ’ can be used as ‘parking garage’, referring to the place where cars are kept/saved/stored (that is, ‘parked’). *Verslun* ‘shop-NMLZ’ from the verb *versla* ‘to shop’, can refer to a store, that is, the place where shopping happens.<sup>13</sup> But again, this is not always possible, and sometimes a compound must be used. *Kennslustofa* ‘teach-NMLZ-office’ refers to a classroom (the place where teaching happens), and the nominal *kennsla* ‘teach-NMLZ’ from the verb *kenna* ‘teach’ does not mean this on its own. The verb *kvitta* can mean ‘acknowledge’ or ‘give a receipt’, and the nominal *kvittun* can refer to the receipt itself (the piece of paper), which is the thing given or a physical manifestation of the acknowledgment. This seems to be an inanimate patient reading.

<sup>11</sup> Note, however, that a reservation is not a place where ‘reserving’ takes place, so in a sense it is both a location nominal and something like an inanimate patient nominal.

<sup>12</sup> The state reading of *attainment* mentioned in the discussion surrounding (11) seems to be an example of this.

<sup>13</sup> It is very common to see this nominal in the plural *verslanir* ‘shops’, for example on signs in a parking garage directing the reader to the place where the shops can be found.

If all of these readings are to be derived from the same structure, namely the one in (17), then there appears to be a lot of root-specific contextual allosemy governing the semantic interaction between *n* and the root.

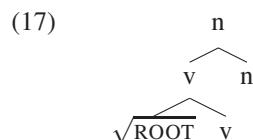

To give just one example, while a *residence* refers to a place where someone resides, a *living* does not easily (or at all) refer to a place where someone lives. It is not obvious that this comes from the meaning of the verb *live* versus *reside*, so we might have to say that this is a specific alloseme of *n* (location), whose distribution is sensitive to the choice of the root  $\sqrt{\text{LIVE}}$  versus the root  $\sqrt{\text{RESIDE}}$ .<sup>14,15</sup> However, before discussing the interaction of the root and *n* in such cases and what it means for the theory of allosemy, it is important to point out that we must be cautious about the conclusions we draw from examples like *living* versus *residence* regarding the locality conditions of root $\leftrightarrow$ *n* allosemy interactions. In the current framework, it is entirely possible that some result nominals are actually root-derived nominals, as in the structure in (18).

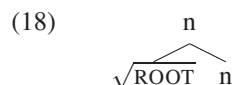

Recall that the argument against this structure was an argument against a layering approach to the general ambiguity of deverbal nouns. It was argued that (18) could not be the structure of CENs, because it would not account for argument structure inheritance, Borer's Generalization about the existence of verbs underlying CENs, Lieber's Generalization that noun affixes with eventive meaning always have some referential meaning, or the presence of verbalizing morphology. However, the first two arguments apply only the CENs, and the third only says that the structure in (17) must be able to generate some RN readings, not that the structure in (18) does not also exist with roots that can occur in (17). It is entirely possible, even likely, that some apparently "deverbal" nominalizations are really (18). Structures like (18) are irrelevant to the question of the locality of allosemy, since we already know that there will be idiosyncratic interaction between a root and a nominalizer when the nominalizer attaches directly to the root.

The structure of *residence*, *government*, or *reservation* could be (18). In fact, *residence* and *government* seem to resist CEN readings, so it may be that they only have the structure in (18), and not (17) at all. A nominal like *reservation* can certainly have a CEN reading, as in *Her frequent reservation of the square table drove me crazy*. But still, it could be that CEN reading has the structure in (19) while the location reading has the structure in (20).

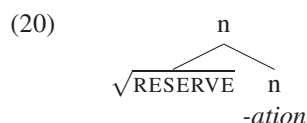
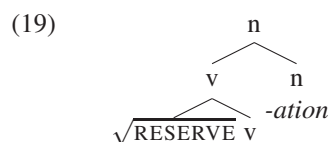

Moreover, it is possible that some referential readings have the structure in (19); for example, a reservation might refer to a piece of paper used to verify the details of a previous reservation event (as in, "Do you have your reservation on you?"). It could be that this reading, which is less idiosyncratically connected to the verbal meaning of *reserve* than the location reading is, has the structure (19) (just as the CEN reading does), while the location reading has the structure in (20). Then, the location reading would be irrelevant to the question of how the nominalizer interacts with the root past *v*, while the "piece of paper" reading would not be irrelevant.

Therefore, in order to evaluate the locality of allosemy, and the range of readings available to truly deverbal nominalizations, it is important to be sure that we are dealing with the structure in (17). The surest way to do so is to consider, for referential readings, only those nominalizations with an overt *v* head. This guarantees that there is a *v*

<sup>14</sup> Of course, *live* and *reside* are not identical, so it is possible that this difference can be derived from the meanings of the roots themselves. Determining the plausibility of this approach to all such contrasts goes beyond the scope of the present study.

<sup>15</sup> A logically distinct issue is whether *n*, or an alloseme of *n*, can trigger a distinct alloseme of a root—something like semantic suppletion of a root—or whether the root can be given a core meaning at the *v* level (regardless of whether *v* is semantically zero or contentful), which is then "semantically readjusted" to fit the structural meaning imposed by the chosen alloseme of *n*.

present, and any readings attained cannot be attributed to a root-derived structure.<sup>16</sup> In English, I do not know of any agent, location, or instrument readings derived from a verb with an overt verbalizer. If I and some colleagues form a group to *galvanize* the voters, we cannot be referred to as the *galvanization*; nor can any tool we use for this purpose be called a *galvanization*, or any place we do this the *galvanization*. Similarly, *victimization* can have a CEN reading, and can refer to a result state, but cannot refer to any agent, instrument or place.<sup>17</sup>

Consider the situation with location nouns. We noted before that *residence* has a location reading and *living* does not. Suppose that the location alloseme of *n* is (21).

$$(21) \quad \llbracket n \rrbracket \leftrightarrow \lambda P_{(s,t)} \lambda x \exists e. P(e) \ \& \ \text{place}(x)(e)$$

In this case, we submit the roots for  $\sqrt{\text{LIVE}}$  and  $\sqrt{\text{RESIDE}}$  into the formula, and the result is as in (22).

$$(22) \quad \begin{array}{ll} \text{a.} & \lambda x \exists e. \sqrt{\text{LIVE}}(e) \ \& \ \text{place}(x)(e) & = \text{location} \\ \text{b.} & \lambda x \exists e. \sqrt{\text{RESIDE}}(e) \ \& \ \text{place}(x)(e) & = \text{location} \end{array}$$

Note that according to what we said above, (22a) should be anomalous while (22b) acceptable. There are two possible explanations for this. First, the alloseme in (21) might not be inserted in the context of the root  $\sqrt{\text{LIVE}}$ , so (22a) is never generated in the first place. Second, the alloseme might be fine, but the root  $\sqrt{\text{LIVE}}$  might be conceptually incompatible (nonsensical) in the formula in (22a).

It is hard to imagine why the second reason would hold. All that is necessary is that *reside* and *live* are both modify/describe events—which they do—and that both are compatible with the place relation; and however we define this relation, it is hard to imagine how the roots would differ with respect to it. Both even have a meaning (or root alloseme) that makes them more or less equivalent, as in ‘I live/reside on Dexter Street’. Instead, it seems that the most plausible explanation is that the root  $\sqrt{\text{RESIDE}}$  conditions the insertion of the *n* alloseme in (21), while the root *live* does not. Therefore, if we had reason to believe that both *residence* and *living* had the truly deverbal structure in (17), we would be forced to say that allosemy of *n* is sensitive to the root, past *v*. However, as of now we have no reason to assume that *residence* and *living* both have this structure, so we are not yet led to this conclusion.

There is at least one case in Icelandic, however, that does point in this direction. The noun *hreinsun* ‘cleaning’, derived from the verb *hreinsa* ‘clean’, has a location meaning, referring to a laundromat or dry cleaners. This meaning is most typically found in the compound *fatahreinsun* ‘clothes cleaning’, but can also be found in isolation, as in the attested example in (23).

- (23) Ég get ekki þvegið áklæðið í þvottavél, en það má fara í  
 I can not wash upholstery.the in washing.machine, but it may go to  
**hreins-un** (hef ekki athugað hvað það kostar).  
 clean-VBLZ-NMLZ (have not checked what that costs)  
 ‘I can’t wash the upholstery in a washing machine, but it can go to the cleaners  
 (haven’t checked what that costs).’<sup>18</sup>

What is relevant here is the fact that *hreinsun* contains the overt verbalizer *-sa*. The adjective *hreinn* ‘clear’ is built on the same root. Thus we have the structure in (17), with *-sa* realizing *v*, and *-un* realizing *n*. But the root *hrein* conditions the alloseme in (21), past *v*.

<sup>16</sup> There are other, less direct ways to increase one’s confidence that a *v* is present in the structure. One is to focus on verbs derived from roots that have independent nominal forms. For example, the verb *safna* ‘collect’ in Icelandic is derived from the root  $\sqrt{\text{SAFN}}$ , which occurs independently in the noun *safn*, and can refer to a collection, museum, etc. This is probably derived from a root attached *n*. The form *söfn-un*, then, seems to be derived from the verb, since it has a CEN reading and an overt nominalizer. However, it is still not out of the realm of possibility that there are two different ‘flavors’ of *n*, and one of them is morphologically  $\emptyset$  while the other is *-un*. (See also Embick 2016.) Part of the driving intuition behind the present work is to limit such flavors to cases where the form-meaning correspondence is as straightforward as possible, so this would not be an ideal analysis. But the overall situation is not as straightforward as when there is an overt verbalizer. Intriguingly, Eik (2019) argues that in Norwegian, when a compound has the structure  $[[A\ B]\ C]$ , with *C* as the head and the non-head is itself a compound comprised of *A* and *B*, the non-head  $[A\ B]$  must be categorized and cannot consist solely of two bare roots. If this is correct, it could serve as a configurational diagnostic for the presence of a categorizing head even when that head is not overt. Exploring this possibility is unfortunately well beyond the scope of the present work.

<sup>17</sup> Shelly Lieber (p.c.) notes that agent, instrument and location readings are rare in the first place, so it may be that by limiting the search to cases with overt verbalizers, readings that are possible in principle are missing by accident. Nevertheless, my own methodological stance is that we should evaluate how flexible our theory needs to be on the basis of the strongest possible cases, and not assume that gaps are accidental.

<sup>18</sup> <https://bland.is/umraeda/yfirbreidsla-yfir-sofa/6615138/>, retrieved July 18, 2019

This example is telling in another way. Despite the fact that *hrein* may condition allosemy on n past v, the root itself does not get any special meaning conditioned by n, past v. The root makes the same basic contribution in the location noun that it does in other contexts. So we have evidence of interaction between root and n past v, but only in one direction. This is in contrast with the readings available to a root like  $\sqrt{\text{PVO}}$ , in the nominal *þvottur*. Since there is no overt v here, *þvottur* could have two possible structures.

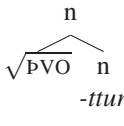
- (24) 
- (25) 

We have evidence that (24) exists, since the CEN reading is available.

- (26) Guðrún þvoði fötin.  
 Guðrún.NOM washed clothes.the.ACC  
 ‘Guðrún washed the clothes.’
- a. þvo-ttur Guðrúnar á fötunum  
 wash-NMLZ Guðrún.GEN on clothes.the.DAT  
 ‘Guðrún’s washing of the clothes’ (CEN)
- b. þvo-ttur fatanna  
 wash-NMLZ clothes.the.GEN  
 ‘the washing of the clothes’ (CEN)

However, *þvottur* can also refer to the clothes themselves—the ‘laundry’—with no eventive meaning at all.

- (27) Þvo-ttur-inn á að fara í vélina.  
 wash-the-NMLZ ought to go in machine.the.ACC  
 ‘The laundry (lit. ‘the washing’) should go into the washing machine.’ (RN)

This is a more arbitrary contribution of the root than was found with *hreinsun* above. If we knew that *þvottur*, with this meaning, involved the structure in (24), we would be led to say that the n head can condition allosemy of the root, past v. However, there is nothing forcing this, as this reading may well be derived from the root-attached structure in (25).

With this much in mind, we can ask about what other referential readings must be derivable from the structure in (17), and whether these readings involve allosemy of n conditioned by the root (past v), or allosemy of the root conditioned by n (past v). Consider first the readings available to *móð-g-un*, derived from the verb *móð-ga* ‘insult’ with the verbalizer *-ga*. This can refer to the content of a proposition/utterance created in an event of insulting someone. The nominal *þræl-k-un* ‘enslavement’ is derived from *þræl-ka* with the verbalizer *-ka*. It can refer to the state of being a slave, or the state of the existence of slavery. The nominal *bród-er-ing* ‘embroidery’ is derived from *bród-era* ‘embroider’, with the verbalizer *-era*. It can refer to the thing created by embroidering. The nominal *ryð-g-un* ‘rusting’ is derived from *ryð-ga* ‘rust’, with overt *-ga*, and can refer to ‘corrosion’, essentially the resulting state of rusting, but also the material resulting from a rusting event. The nominal *pródús-er-ing* ‘production’ is derived from *pródús-era* ‘produce’, with the overt verbalizer *-era*, and refers to the (perhaps abstract) thing that is produced. So at the very least, it seems that overtly deverbal nouns can refer to result readings, state readings, and product readings.<sup>19</sup>

Let us see what it would take to maintain the claim that the root cannot get idiosyncratic meanings conditioned by the semantics of n, past v. Does the distinction between the product reading and the result state reading necessitate distinct allosemes of a root? Certainly, not every root can express both. However, this could be a product of the meanings of the roots and their ability to modify the meanings of various allosemes of n. For example, suppose one of the available allosemes of n is the one in (28).

- (28)  $\llbracket n \rrbracket \leftrightarrow \lambda P_{(s,t)} \lambda x \exists e. P(e) \ \& \ \text{result}(x)(e)$

<sup>19</sup> Interestingly, I have not been able to find any clear RN readings of nouns derived from verbs that are verbalized with *-væða* other than result readings, although the nominal forms certainly exist morphologically. I return to this in detail in section 6.5.

What would it take for a root to occur with this alloseme of *n*? First, it would have to be capable of modifying an event, and second, it would have to be an event that brings a salient entity into existence. At this point, nothing more is said about such an entity; it could be abstract or concrete, for example. If we assume that in our type theory, the set of entities includes states, this could be the denotation of a result state, or a concrete entity that is created in the course of an event.

- (29) a.  $\lambda x \exists e. \sqrt{\text{RUST}}(e) \ \& \ \text{result}(x)(e)$  = result state  
 b.  $\lambda x \exists e. \sqrt{\text{EMBROIDER}}(e) \ \& \ \text{result}(x)(e)$  = result entity

According to this view, the difference between a result state and a result entity would not need to involve the negotiation of a special meaning of roots in the context of *n*. Rather, it would involve the inherent compatibility of roots with one particular *n* denotation; to the extent that speakers can square the conceptual content of the root with the meaning of this one *n*, the question becomes not one of allosemy, but one of lexical/conceptual semantics. In one case, the result entity consists of concrete material, and in another case it does not. This might be understood as the kind of ‘semantic readjustment’ of the root alluded to above.

Now suppose that the distinction between a result state and a result entity must be encoded in the formula. Then we would have two allosemes as in (30) and (31) below. Here I borrow the predicate ‘material’ from the feature  $[\pm\text{material}]$  in Lieber (2017, 94), which distinguishes between concrete entities ( $[+\text{material}]$ ) and abstract entities ( $[-\text{material}]$ ).

- (30)  $\llbracket n \rrbracket \leftrightarrow \lambda P_{\langle s,t \rangle} \lambda x \exists e. P(e) \ \& \ \text{result}(x)(e) \ \& \ \text{state}(x)$   
 (31)  $\llbracket n \rrbracket \leftrightarrow \lambda P_{\langle s,t \rangle} \lambda x \exists e. P(e) \ \& \ \text{result}(x)(e) \ \& \ \text{material}(x)$

In principle, we would ask if each of these two allosemes can occur with all roots.

- (32) a.  $\lambda x \exists e. \sqrt{\text{RUST}}(e) \ \& \ \text{result}(x)(e) \ \& \ \text{state}(x)$  = result state  
 b.  $\lambda x \exists e. \sqrt{\text{RUST}}(e) \ \& \ \text{result}(x)(e) \ \& \ \text{material}(x)$  = result entity  
 c.  $\lambda x \exists e. \sqrt{\text{EMBROIDER}}(e) \ \& \ \text{result}(x)(e) \ \& \ \text{state}(x)$  = result state  
 d.  $\lambda x \exists e. \sqrt{\text{EMBROIDER}}(e) \ \& \ \text{result}(x)(e) \ \& \ \text{material}(x)$  = result entity

The readings in (32)a,b) seem to be available; the result of rusting can be a state or a concrete entity. But suppose that, say, ‘embroidery’ lacks a result state reading, so that the reading in (32c) is not actually possible. This could be because the alloseme in (30) is idiosyncratically not available in the context of the root  $\sqrt{\text{EMBROIDER}}$ , or because the meaning in (32c) simply does not compute; it does not square with what we know about embroidering events. The first explanation would require that the root interacts directly, by conditioned allosemy, with *n*, past *v*. The second explanation does not. It would say that the formula in (32c) is grammatical, but that we do not conceive of any result states coming into existence as a result of embroidering; there is no ‘state of embroidery’. According to this view, if the world changed such that the act of embroidering led to some abstract state, then (32c) would make sense and become automatically available. This would not be allosemic interaction between the root and *n*; it would simply be a matter of the conceptual semantics of a root in the context of a particular structural semantics.

For the result state versus result entity (product) readings, it is not clear to me that any direct allosemy is necessary, in either direction. To the extent that a root is capable of naming an event that creates a result, that result can be an abstract state or a concrete product. On the other hand, the distinction between simple event, simple state, and simple entities arguably are instances of allosemy of *n*, conditioned by the root. However, even in these cases, it is not clear that the root undergoes allosemy (rather than readjustment) in a way that is conditioned by *n*.

In contrast, the inanimate patient nominal readings arguably involve distinct allosemes of the root and distinct allosemes of *n*. While result meanings are connected semantically to an event meaning of the root, the inanimate patient readings are not. As mentioned above, *þvottur* in its use meaning ‘laundry’ plausibly involves a distinct alloseme of the root  $\sqrt{\text{ÞVO}}$ . However, I have so far not come across any Icelandic examples of this reading with an overt verbalizer, with the exception of cases where the ‘patient’ is in fact a product, something created by the event. I propose that these two kinds of inanimate patient nominal readings are connected with two distinct allosemes of *n*, as shown in (33) (without contextual restrictions).

- (33) a.  $\llbracket n \rrbracket \leftrightarrow \lambda P_{\langle s,t \rangle} \lambda x \exists e. P(e) \ \& \ \text{result}(x)(e)$  Product Reading (if concrete)  
 b.  $\llbracket n \rrbracket \leftrightarrow \lambda P_{\langle e,t \rangle} \lambda x. P(x)$  Inanimate Patient Reading

(33a) will derive an entity whose existence is the result of some event, whereas (33b) will derive some entity, with no claims made about any relationship to an event. (33a) is connected to the meaning of the verb, since the verb will also involve an event variable, while (33b) is more idiosyncratic, having to do with the range of meanings a root makes available in the first place. It is in fact not a special “inanimate patient reading” but rather a simple entity reading, which for some roots will happen to correspond to an entity that can be an inanimate patient. If it is true that *n* cannot condition idiosyncratic allosemes of roots, the use of (33b) will be quite limited in the context of truly deverbal structures, perhaps not useable at all.

Notice, however, that as it is stated here, nothing is said about the relationship between the kind of entity and the argument structure of the underlying verb. Neither of the formulas in (33) say whether or not the entity corresponds to the object of the verb. I take this to be a welcome result, and it in fact unifies some of the distinctions discussed by Melloni (2010). Melloni (2010) argues that an RN derived from a verb of creation will refer to the object of that verb; when you *construct a house*, you bring a house into existence, so a *construction* refers to the object (i.e., the house). One can (awkwardly) say, “I constructed that construction.” An RN derived from a “creation by modification” verb also refers to the entity created in an event, but this is not the object in a verb phrase. When you *modify a house*, you do not bring a house into existence, so *modification* does not refer to the object of the verb (i.e., the house). One cannot say, “I modified that modification” (unless there were two modification events). She makes a similar point about verbs like ‘translate’. When you “translate that passage” you do not create “that passage,” but you do create something, and that something can be referred to as a *translation*. I contend that these differences need not make any reference in the grammar to what the object of a verb would have been. Rather, they all follow from something like (33a) (or possibly (30)/(31)): the derived noun refers to the entity that comes into existence as the result of the event. The fact that ‘construct’ has a different relationship with its object in a verb phrase or CEN than ‘modify’ does with its object is a fact about complex event semantics, constructed in the verb phrase and CEN nominals, not RN semantics.

Some roots may be possible with both allosemes. The noun *transmission* certainly has a result-like meaning, where (somewhat like *translation*) it can refer to the thing that comes into existence as a result of a transmitting event (e.g. a piece of paper containing a message), as would be expected with the denotation in (33a). However, it can also refer to a gearbox in a car, in which case it is most likely derived from the denotation in (33b). Nevertheless, since there is no overt verbalizer in *transmission*, it could easily be the case that the gearbox reading involves a root-attaching *n*, while the result reading is involves a verb-attaching *n*, or it could be that both readings involve the same structure, with different allosemes chosen for *n*.

Turning to the simple event reading, I proposed earlier that it does have a separate alloseme, which I repeat here (without contextual restrictions):

$$(34) \quad \llbracket n \rrbracket \leftrightarrow \lambda P_{(e,t)} \lambda x \exists e. P(x) \ \& \ x = e \quad \text{SEN Reading Version 1}$$

This takes a predicate of entities and returns the set of entities that are equal to an event. However, another possibility, given the denotation for inanimate patient nominals, would be to do this the other way round.

$$(35) \quad \llbracket n \rrbracket \leftrightarrow \lambda P_{(s,t)} \lambda x \exists e. P(e) \ \& \ x = e \quad \text{SEN Reading Version 2}$$

This takes a predicate of events and returns a set of entities that are equal to an event. The distinction between these two is a subtle one, and it is entirely possible that both are available to UG. However, the former predicts that the event variable should be targetable for some kinds of word internal eventive modification, while the latter does not. While I will not resolve the matter fully, I turn in the next subsection to the kind of modification that may be able to make such distinctions, and there I argue that in fact, Version 1 is empirically correct for at least some SENs (although it remains possible that some SENs are derived from Version 2, which could mean that these are two distinct allosemes).

In sum, while the system here does allow the root to condition a specific alloseme of *n* past *v*, we do not see evidence that *n* may condition idiosyncratic allosemy of roots past *v*. This explains why some roots can have SEN and RN readings and others cannot, even if the range of verified RN readings in this structural environment turns out to be more limited than it might at first seem. However, among those readings, the roots that combine with them may undergo only minor adjustments, and some roots may be incompatible semantically with certain allosemes of *n*. In such cases, I proposed that simple conceptual shifts would make the relevant readings automatically available, with no change in the grammar or rules of allosemy.

## 6.4 *Marg-* ‘many’ and *endur-* ‘re-’ prefixation

While there are numerous verbal prefixes in Icelandic, the syntax and semantics of many (perhaps most) of them have not been subjected to detailed theoretically-driven study. There are some notable exceptions.<sup>20</sup> Maling (2002a) discusses several prefixes, including most notably *sam-* ‘together’, in the context of case-marking patterns. Jónsson (2003) discusses intensifying prefixes and how they can diagnose different classes of psych-verbs. Whelpton (2007) is discusses resultative prefixes (which he refers to as compounds, the difference being immaterial here). Jóhannsdóttir (2011) briefly discusses the prefix *sí-* ‘always’, and how it interacts with the interpretation of present participles. Gast et al. (2016) provides a detailed study of *of-* ‘over-’ prefixation, identifying numerous interesting patterns connected with verbal interpretation and argument structure. However, by and large, this is an understudied area of Icelandic morphosyntax. In this section, I will discuss two prefixes in particular and show how they bear on the analysis of nominalizations. My hope is that future studies will explore other prefixes, including but not limited to the ones in the works mentioned above, in the same way in order to understand them better and to shed further light on the analysis of nominalizations.

### 6.4.1 *Marg-* ‘many’ prefixation

Many Icelandic verbs can be prefixed with *marg-*, which is the stem for the word ‘many’. In this section, I suggest that *marg-* prefixation supports the distinction between the CEN and SEN readings, as it is only compatible in its predictable, compositional use, with a CEN reading when it occurs on a noun derived from a verb. E.F. Sigurðsson (2015) proposes that it acts as an event modifier, adding iterativity. His denotation is shown in (36) (E.F. Sigurðsson, 2015, 49).

$$(36) \quad \llbracket \textit{marg-} \rrbracket = \lambda P_{\langle s,t \rangle} \lambda e. P(e) \ \& \ \textit{iter}(e)$$

As shown in this denotation, E.F. Sigurðsson (2015) argued that *marg-* must have scope over the entire event denoted by the vP. He furthermore suggested that it attaches syntactically to the vP it scopes over. In contrast, I will assume that *marg-* may adjoin directly to v at the complex head level. I will now show that when a verb that is prefixed with *marg-* ‘many’ is nominalized, it may only receive the CEN reading.

First, consider (37), where we see that *þvo* ‘wash’ can be nominalized as a CEN (37a–b), an SEN (37c), or an RN (37d).

- (37) Guðrún þvoði fötin.  
 Guðrún.NOM washed clothes.the.ACC  
 ‘Guðrún washed the clothes.’
- a. þvo-ttur Guðrúnar á fötunum  
 wash-NMLZ Guðrún.GEN on clothes.the.DAT  
 ‘Guðrún’s washing of the clothes’ (CEN)
- b. þvo-ttur fatanna  
 wash-NMLZ clothes.the.GEN  
 ‘the washing of the clothes’ (CEN)
- c. Þvo-ttur-inn tók langan tíma.  
 wash-the-NMLZ took long time  
 ‘The washing took a long time.’<sup>21</sup> (SEN)
- d. Þvo-ttur-inn á að fara í vélina.  
 wash-the-NMLZ ought to go in machine.the.ACC  
 ‘The washing (=laundry, clothes to be washed) should go into the washing machine.’ (RN)

<sup>20</sup> Here I am focusing on prefixes other than the prepositional prefixes discussed elsewhere in this work, although the discussion of *af-* prefixation in section 6.5.3 shows that this distinction is not necessarily a clear one.

<sup>21</sup> Oddur Snorrason (p.c.) points out that for him, this example has a very salient ‘washing machine’ reading.

To illustrate the fact that *marg*-prefixation is only available with a CEN reading, consider (38) below.<sup>22</sup>

- (38) Guðrún marg-þvoði fötin.  
 Guðrún.NOM many-washed clothes.the.ACC  
 ‘Guðrún repeatedly washed the clothes.’
- a. marg-þvo-ttur Guðrúnar á fötunum  
 many-wash-NMLZ Guðrún.GEN on clothes.the.DAT  
 ‘Guðrún’s repeated washing of the clothes.’ (CEN)
- b. marg-þvo-ttur-inn á fötunum  
 many-wash-NMLZ-the on clothes.the.DAT  
 ‘The repeated washing of the clothes.’ (CEN)
- c. marg-þvo-ttur fatanna  
 many-wash-NMLZ clothes.the.GEN  
 ‘the repeated washing of the clothes’ (CEN)
- d. \*Marg-þvo-ttur-inn tók langan tíma.  
 many-wash-the-NMLZ took long time  
 INTENDED: ‘The repeated washing took a long time.’ (SEN)
- e. \*Marg-þvo-ttur-inn á að fara í vélina.  
 many-wash-the-NMLZ ought to go in machine.the.ACC  
 ‘The repeated washing (=laundry, clothes to be repeatedly washed) should go into the washing machine.’ (RN)

The examples in (38a–c), which have an internal argument, are acceptable, while the SEN and RN examples in (38d–e) are sharply out. This is what we would expect if *marg*- prefixation is only possible with the CEN reading.

Corroborating the claim that iterative *marg*- only prefixes to nouns in the CEN reading derived directly from the meaning of the verb, most of the attested examples of nominalizations prefixed with *marg*- appear with an overt internal argument. The following examples are taken from the RMH corpus.

- (39) a. **marg-flokk-un** á þessum hlutum  
 many-sort-NMLZ on these things  
 ‘sorting of these things over and over’
- b. ansi mikil **marg-endurtek-ning** á því  
 rather much many-repeat-NMLZ on it  
 ‘so much repeating of it over and over’
- c. **marg-not-k-un** eiginfjárliða  
 many-use-VBLZ-NMLZ equity.items.GEN  
 ‘use of equity items over and over’
- d. **marg-nýt-ing** gjaldþolsliða  
 many-utilize-NMLZ solvency.margin.elements.GEN  
 ‘utilization of solvency margin elements over and over’

<sup>22</sup> Note that some speakers find *marg*- to be unacceptable in all nominalizations. Some prefer the *á*-PP to the genitive for the internal argument. Some speakers find the attested example of *margþvottur* below better than the constructed examples, and (i) does seem to be a CEN—it has an event reading and an internal argument.

(i) það kostar miklu meira vesen sem tekur allan sparnað burt.. eins og **marg-þvo-ttur** á **blettunum** óneitanlega gerir.  
 it costs much more trouble which takes all savings away like many-wash-NMLZ on stains undeniably does  
 ‘it causes much more of a hassle which takes all the savings away... like the repeated washing of stains undeniably does.’  
<https://danjensen.blog.is/blog/danjensen/entry/563317/>, retrieved 11/13/18

At least one speaker who found *margþvottur* quite bad, however, still found the SEN and RN examples to be worse. Possibly, for speakers who reject all instances of nominalized *marg*-, it does attach it at the vP level, just as E.F. Sigurðsson (2015) proposes. If so, this is further support for the present complex head analysis of nominalizations, since a Phrasal Layering approach would be hard-pressed to explain why vPs with *marg*- are impossible for some speakers, while the present approach offers a straightforward account of this variation.



- e. Við höfum kallað það **marg-nýt-ingu** á manneskju sem vöru.  
we have called that many-utilize-NMLZ.ACC on person as commodity  
‘We have called that utilization over and over of a person as a commodity.’
- f. eftir **marg-birt-ingu** þáttanna  
after many-publish-NMLZ parts.the.GEN  
‘after the publishing of the parts over and over’
- g. Við **marg-endur-skoð-un** á samsetningu notkunar hans...  
with many-re-inspect-NMLZ on combination uses.GEN its.M  
‘with reinspection over and over of the combination of uses of it...’

The *marg-* nominalization in each of these examples occurs with an internal argument, and also has a predictable, compositional meaning that is directly predictable from the meaning of the verb in the absence of *marg-* and the nominal that would be derived from it.

There are some nominalizations prefixed with *marg-* do appear without any internal argument. However, they generally involve a noticeably different use or meaning of the prefix, including idiosyncratic meanings or technical terms. For example, *margspeglunin* ‘the many-reflection’ in (40a) does not refer to many reflecting events, but rather refers to the scattering of light into many directions as part of one reflecting event. Similarly, *margröddunin* ‘the many-voicing’ in (40b) does not refer to many voicing events (i.e., voicing something over and over again), but rather to the coming together of different voices in a harmony. Finally, *margskipting* ‘many-division’ in (40c) is not problematic in the first place, since it does include an argument, but I note that *margskipting* here (and the verb *margskipta* that it is derived from) is ambiguous between the “over and over again” reading and a reading of one division event that divides something into many parts.

- (40) a. getur stór hluti ljósorkunnar endurvarpast frá froðunni og  
can large part light.energy.the.GEN rebound from foam.the and  
**marg-spegl-un-in** fær einkenni ljósdreifingar  
many-reflect-NMLZ-the gets properties light.scatter  
‘... a large part of the light energy can rebound off of the foam and the “multi-reflection” acquires the properties of light scatter’
- b. En rödd Sindra er hér of sterk til að **marg-rödd-un-in** gangi upp  
but voice Sindri.GEN is here too strong for that many-voice-NMLZ-the walks up  
‘But Sindri’s voice is too strong here for the harmonizing to work.’
- c. Þar má nefna **marg-skipt-ingu** radda  
there may name many-divide-NMLZ voices.GEN  
‘there one may name the division of voices over and over’  
‘there one may name the division of voices into many parts’

I take these uses of *marg-* to be distinct from the use discussed above which involves iteration of an event. The examples in (41) are similar. (41a) does not just refer to repeated education events. It has a “redundancy” reading, related to the repetition of the result. I could educate someone over and over again, but never be redundant, focusing on different topics on different occasions; but this is not the meaning of *margmenntun* in (41a). (41b) has an internal argument, but may well be a SEN or RN, since it is plural. However, this too has a different reading. It does not simply mean that the same parts are insured over and over again, for example if the insurance only lasts a week and must be constantly renewed. It too has a redundancy reading, meaning that the same parts are insured in different ways.

- (41) a. **Marg-mennt-un** er dýr, þ.e. þegar fólk er skikkað til að sitja á  
many-educate-NMLZ is expensive, that.is when people are forced for to sit á  
skólabeck og læra hluti sem það kann fyrir.  
classroom and learn things that they know  
‘Redundant education is expensive, that is, when people are forced to sit in a classroom and learn things that they already know.’

- b. **marg-trygg-ing-ar** á sömu þáttum  
 many-insure-NMLZ-PL on same parts  
 ‘insurances of the same parts in different ways’

As above, I take these readings to involve a different use of *marg-*, not one that adds iterativity to the meaning of an event. Finally, some instances of *marg-* nouns without an internal argument involve idiosyncratic or entirely unpredictable meanings, even on the roots. For example, *margföldun* in (42a) is derived from *margfalda* ‘multiply’, but there is no verb *falda* that it is related to.<sup>23</sup> In (42b), *margbeiting* is essentially a coinage to mean ‘multitasking’, which is not predictable on its own. Speakers report that they would need to be told explicitly that *margbeiting* has this meaning, unlike the iterativity examples above.

- (42) a. voru 15 keppendur skráðir til leiks sem er **margföld-un** í  
 were 15 contestants signed.up for play which is multiply-NMLZ in  
 þátttöku miðað við síðustu ár  
 participation compared with last year  
 ‘15 contestants were signed up for the game, which is an increase in participation compared with last year.’
- b. en **marg-beit-ing** – það sem útlendingar kalla multi-tasking – er...  
 but many-use-NMLZ that which foreigners call multi-tasking – is...  
 ‘but *margbeiting* – which foreigners call multi-tasking – is...’

I take these uses as well to be distinct from the compositional, iterative meaning. They could be prefixed to the root, *v* or *n*, but wherever they attach, they condition special idiosyncratic root meaning and themselves take on a distinct meaning, much as the idiosyncratic meanings of prepositional prefixes discussed in chapter 4 do. In general, then, the iterative prefix *marg-* is compatible only with the CEN reading, and thus requires an internal argument when it used on a derived nominal. This fact supports the view that the CEN reading is a distinct reading, since there is no a priori conceptual reason why an SEN reading could not be iterative.

Turning to the analysis, I adopt the semantics of *marg-* proposed by E.F. Sigurðsson (2015), previously shown in (36) above, and repeated here in (43).

- (43)  $\llbracket \text{marg-} \rrbracket = \lambda P_{(s,t)} \lambda e. P(e) \ \& \ \text{iter}(e)$

As mentioned above, I propose that *marg-* may adjoin to the *v*-head directly, but by modifying the event, it scopes over whatever the event scopes over. So, for example, ‘many-washing’ the clothes will mean that there are multiple events of clothes-washing, not multiple washing events, one of which is a clothes-washing event. The fact that *marg-* is incompatible with the SEN and the RN reading follows from the claim that there is no event variable introduced by *v* for either reading. The event variable is only there, at the *v* level, in the CEN reading, so *marg-* prefixation is only possible with that reading.<sup>24</sup>

<sup>23</sup> There are archaic uses of *falda* that bear no synchronic relationship to *margfalda*, and some speakers are not even aware of them.

<sup>24</sup> The diagrams below are slightly misleading from a derivational perspective. In this work, as I discussed in chapter 1, I assume that the root is not a predicate of any kind of variable until it combines with something semantically, usually its categorizer. At that point, it takes whatever type it needs to take. So when the semantics is computing these structures, at the point where *marg-* is combining with *v*, one of two things will happen. The first possibility is that the *v* node will at this stage have no denotation, if the  $\emptyset$  alloseme of *v* is chosen; in this case, the semantics fails, as it cannot combine *marg-* and *v*. The second possibility is that the root will be forced to take on an eventive meaning in order to combine with *marg-* semantically. In this second scenario, RN and SEN readings will be unavailable because the root will already have an eventive meaning.

(44) a. RN

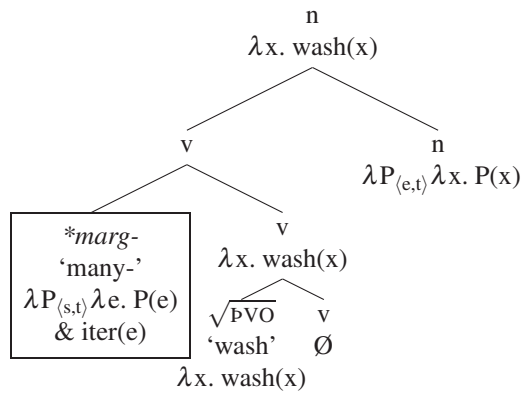

b. SEN

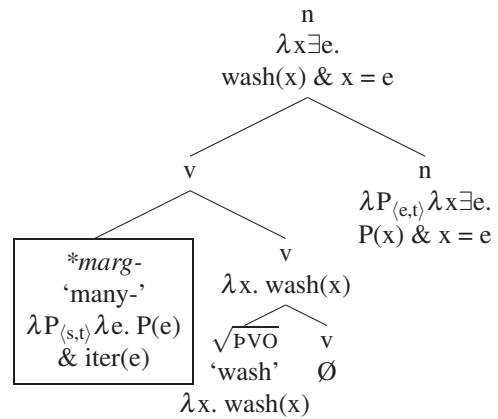

c. CEN

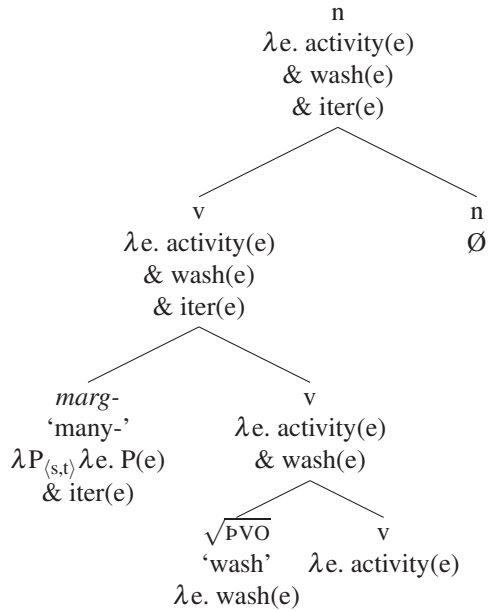

Support for taking *marg-* to attach to a complex v head rather than the vP comes from the fact that equivalent or analogous phrasal modifiers are not possible in nominalizations. If *marg-* attached to a vP, then its presence in nominalizations would require us to assume that such nominalizations do indeed contain a vP. In this book, I have presented numerous arguments against this assumption for the Icelandic nominalizations in question. But we can go further, because if *marg-* is showing us that vP modifiers are possible in nominalizations, then we would expect phrasal modifiers of vPs to be possible as well, stranded by the head-movement of the verb to the nominalizer. But the fact is that a modifier with the semantics of *marg-* is only possible in a nominalization if it occurs as part of the complex head, specifically the prefix. According to the complex heads view, this fact makes sense: the eventive meaning is entirely internal to the complex head, so modifying that meaning can only occur through head adjunction, not phrasal adjunction.

In sum, the *marg-* prefixation facts broadly provide a novel argument for the CEN reading as a distinct reading in general; there is no a priori reason that SENs could not be iterative. Moreover, and more importantly, they support the view that the CEN distinction exists at the complex head level, without needing any phrasal material. Finally, these facts show that RNs cannot necessarily be formed from eventive semantics. I will explore this latter point in more detail in the next section, in the context of a distinct (but related) set of patterns with a different prefix, namely *endur-* ‘re-’.

### 6.4.2 *Endur- ‘re-’ prefixation*

Another prefix that has previously been proposed to attach at the phrasal level is *endur-* ‘re-’. Wood (2009b) adopted Marantz’s (2009a; 2009b) analysis of English *re-*, and proposed that it attaches syntactically to the direct object, and moves by head-movement to the verb. E.F. Sigurðsson (2015) provided further support for this view from facts about particle prefixing. However, the same problem arises here that I discussed in the previous section with respect to *marg-* ‘many’ prefixation. We will see that the prefix *endur-* can modify nominalized verbs in a way that vP adverbs like *aftur* ‘again’ or *á ný* ‘again’ cannot. However, we can go further than this, because unlike *marg-*, *endur-* does allow SEN and a certain subtype of RN readings, and this makes the contrast even sharper—*prentun aftur* ‘printing again’ or *prentun á ný* ‘printing again’ cannot be used to refer to the result of a reprinting event, while *endurprentun* ‘reprinting’ can. If *endur-* attaches at the phrasal level syntactically and ends up on the verb purely as a product of morphology, then it is not clear why unambiguously phrasal modifiers cannot attach at that level too, prior to nominalization.

Marantz’s (2009a; 2009b) argument that English *re-* must attach to the direct object DP, extended to *endur-* by Wood (2009b), had to do with its semantic scope. Specifically, he argued that *re-* scopes only over the end state of a change of state verb, not the activity that causes the change of state. If it attached to the verb, we would expect it to scope over the activity as well. Moreover, direct objects are generally obligatory with *re-*, even when they aren’t without *re-*. This also follows if *re-* attaches to a direct object DP. This part of the analysis could be extended to the present account of CENs quite naturally. We could say that in nominalizations, *endur-* attaches to the PP or genitive DP complement in the same way, and raises by head-movement to the n head. In fact, Marantz (2009a,b) specifically argues that *re-* attaches to the *of*-PP complement in nPs like *rebirth of the idea*, which are headed by nouns (like *birth*) that are not necessarily synchronically derived from any verb.

The challenge to this view that is relevant here comes from the fact that while direct objects may generally be obligatory with verbs, they are not obligatory with nominalizations, in particular with the SEN or RN interpretations. With SEN and RN interpretations, objects are actually the exception rather than the rule. We will see below that *re-* and *endur-* are possible with SEN and (a subtype of) RN readings of nominalizations, and in those cases, there is generally no object, either syntactically or semantically. I therefore instead propose that *endur-* attaches directly to the complex head. But this analysis is only possible if the direct building of complex heads is supported to begin with. In fact, we can note at this point that the argument in connection with the scope of *endur-* can be accommodated as well: we have already seen in chapter 5 that the present analysis requires that the change of state semantics, including the end state variable, must be available at the complex head level, so there is no obstacle in taking *endur-* to target such state semantics.

We begin by repeating in (45) the observation from (37) above that *þvo* ‘wash’ can be nominalized as a CEN (45a–b), an SEN (45c), or an RN (45d).

- (45) Guðrún þvoði fötin.  
 Guðrún.NOM washed clothes.the.ACC  
 ‘Guðrún washed the clothes.’
- a. þvo-ttur Guðrúnar á fötunum  
 wash-NMLZ Guðrún.GEN on clothes.the.DAT  
 ‘Guðrún’s washing of the clothes’ (CEN)
- b. þvo-ttur fatanna  
 wash-NMLZ clothes.the.GEN  
 ‘the washing of the clothes’ (CEN)
- c. Þvo-ttur-inn tók langan tíma.  
 wash-the-NMLZ took long time  
 ‘The washing took a long time.’ (SEN)
- d. Þvo-ttur-inn á að fara í vélina.  
 wash-the-NMLZ ought to go in machine.the.ACC  
 ‘The washing (=laundry, clothes to be washed) should go into the washing machine.’ (RN)

The verb *þvo* ‘wash’ can also be prefixed with *endur-* ‘re-’, and when it is, it can still be nominalized as *endurþvottur* ‘rewashing’. However, this nominal *endur-* is compatible with both a CEN reading and an SEN reading, but not with an RN reading.

- (46) *Ég endur-þvoði fötin.*  
 I.NOM re-washed clothes.the.ACC  
 ‘I rewashed the clothes.’
- a. *endur-þvo-ttur Guðrúnar á fötunum*  
 re-wash-NMLZ Guðrún.GEN on clothes.the.DAT  
 ‘Guðrún’s rewashing of the clothes.’ (CEN)
- b. *endur-þvo-ttur fatanna*  
 re-wash-NMLZ clothes.the.GEN  
 ‘the rewashing of the clothes’ (CEN)
- c. *Endur-þvo-ttur-inn tók langan tíma.*  
 re-wash-the-NMLZ took long time  
 ‘The rewashing took a long time.’ (SEN)
- d. \* *Endur-þvo-ttur-inn á að fara í vélina.*  
 wash-the-NMLZ ought to go in machine.the.ACC  
 ‘The rewashing (=laundry, clothes to be rewashed) should go into the washing machine.’ (RN)

However, it is not the case that *endur-* is never compatible with a concrete, RN reading. It is possible in examples like (47):

- (47) **Context**  
*Ég prentaði reglurnar fyrir hana í gær, en nú finnur hún ekki prentunina. Ég þarf að endurprenta reglurnar í dag.*  
 ‘I printed the rules for her yesterday, but now she can’t find the print out. I need to reprint the rules today.’
- Ég vona að hún týni ekki endur-prent-un-inni.*  
 I hope that she loses not re-print-NMLZ-the  
 ‘I hope she doesn’t lose the reprinting.’

Here, *endurprentun* ‘reprint’ refers to the physical object, the piece of paper, that was produced in a reprinting event.<sup>25</sup>

Before turning to the source of the availability or unavailability of the RN readings, I would first like to emphasize that in the SEN reading of *endurþvottur* ‘rewashing’, and the RN reading of *endurprentun* ‘reprinting’, there is no evidence of any direct object. Moreover, recall from the discussion of *marg-* prefixation that the object of *þvottur* ‘washing’ is obligatory with *marg-* in a way that it is not with *endur-*; this means that we cannot simply explain the facts away by assuming that *þvo* ‘wash’ allows silent syntactic objects for the prefix *endur-* to attach to. We instead conclude that *endur-* attaches to the complex head directly, with no syntactic need for a direct object. But in order to do that, the complex head must be syntactically available to begin with. That is, the complex head analysis accounts for why prefixal modifiers like *endur-* are available in nominalizations when their phrasal counterparts (like *aftur* ‘again’ are not): there is no phrase for the phrasal counterparts to attach to, but the prefix can adjoin directly to the head. I will turn now to an account of the distribution of these prefixes within the framework developed there.

So far, the RNs discussed have mostly been analyzed as involving a semantically  $\emptyset v$ , with *n* combining semantically directly with the root. These are the cases that I refer to as ‘Simple Entity Nominals’. However, the result meaning can in principle be built off of an interpreted verb, which is also of type  $\langle s, t \rangle$ , while the Simple Entity reading, which is of type  $\langle e, t \rangle$ , cannot. For example, consider *prentun* ‘printing’ from *prenta* ‘print’, shown in (48a), versus *þvottur* ‘washing’ from *þvo* ‘wash’, shown in (48b).

<sup>25</sup> Likewise, it is possible in English to say *The resubmission that I wanted you to look at is on the table*. Here, *resubmission* refers to the entity that came into existence as a result of an event of resubmitting.

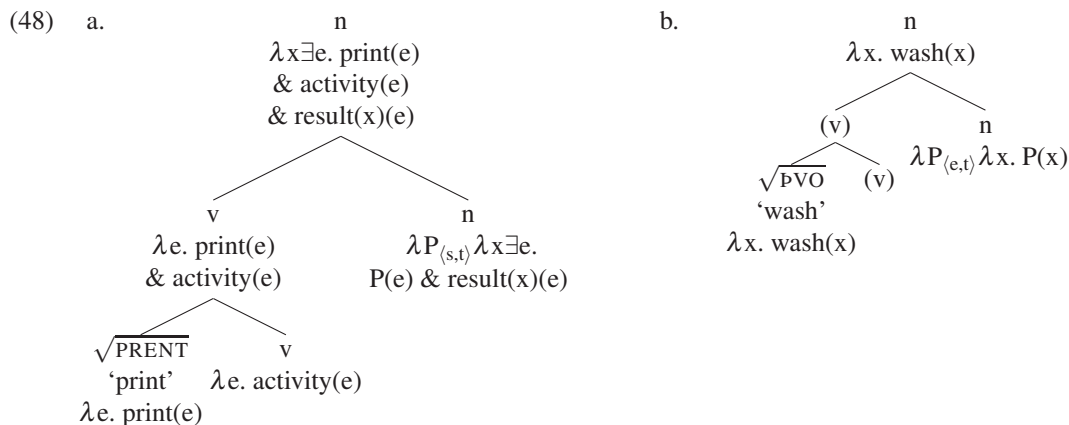

*Printun* ‘printing’ can refer to an object that was created as a result of a printing event—e.g. the piece of paper with content printed on it. In this case, the meaning is totally compositional and predictable from the meaning of the verb, despite being an RN. *Pvottur*, however, refers to material (the laundry) that is perhaps intended to be part of a washing event, but no washing event need ever take place. This meaning is unpredictable (or at least less so). In the present system, this is because *n* interacts directly with the meaning of the verbal root in the second case.

For a *printun* ‘printing’ to exist, there must have been an event of printing, and so there is a semantically contentful *v*. Because of this, the root does not interact directly with *n*; rather, the root gets its meaning from *v*, and a particular alloseme of *n* (the result alloseme) can build on that.<sup>26</sup> In contrast, *pvottur* ‘washing (=laundry)’ can exist without any washing event, so there need not be an event variable or any interpretation introduced by *v*. That is, a basic simple entity alloseme is chosen for *n*, of type  $\langle e, t \rangle$ , which forces the root to be interpreted as a predicate of type  $\langle e, t \rangle$ . What exactly this refers to will fall outside the compositional system, and have to do with the senses of the root that speakers negotiate on a listed basis. (So, we predict that not all languages will allow a noun derived from a verb meaning ‘wash’ to refer to laundry.) The distinction between these two kinds of RN reading predicts that the event meaning can in principle be targeted for modification in the case of the ‘print’-like nominalizations, but not in the case of ‘wash’-like nominalizations.

This is what we find with *endur-* ‘re-’. I propose to understand the facts in (45) and (46), as follows. The prefix *endur-* can adjoin syntactically to either *v* or *n*, and adds the presupposition that the state resulting from the eventuality held before. The claim that it may attach to *n* is supported by an observation by Marantz (2009a,b) that English *re-* can attach to nouns like *birth* (as in *rebirth of the idea*), which are headed by nouns that are not derived (synchronically) from any verb.

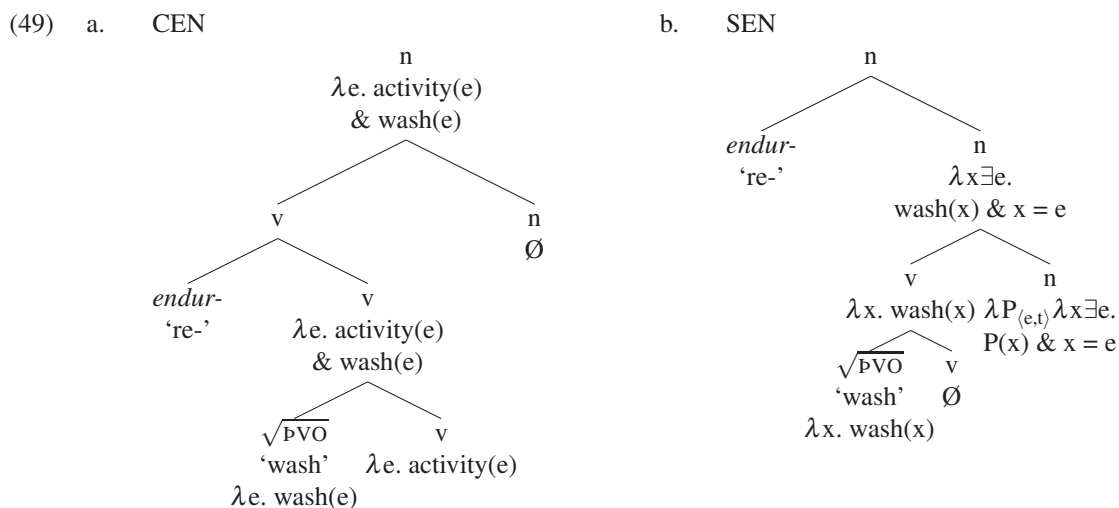

<sup>26</sup> Thanks to Luke Adamson for a thoughtful discussion of this issue.

(50)  $\llbracket \textit{endur-} \rrbracket =$  the state  $s$  resulting from this event held before (presupposition)

I leave the denotation of *endur-* relatively informal, but I assume with Marantz that it adds a presupposition; nothing hinges on this in particular. In both of these cases, whether *endur-* attaches to  $v$  or  $n$ , the presupposition says that the state resulting from washing held before.<sup>27</sup> Crucially, I assume that *endur-* could not attach to  $v$  in the SEN reading, because there is no event variable or eventive reading at that level.<sup>28</sup> It is at the  $n$  level that eventive meaning is obtained.

The RN reading, which is a Simple Entity reading for *þvottur* ‘washing (=laundry)’, is ruled out with either structure. Under the RN reading, *endur-* cannot attach to  $v$ , either because there is no  $v$ , or because there is no event variable there. However, it also cannot attach to  $n$ , because there is no event variable there either; it simply refers to an entity computed from the root  $\sqrt{\text{þVO}}$  ‘wash’ and the simple entity alloseme of  $n$ .

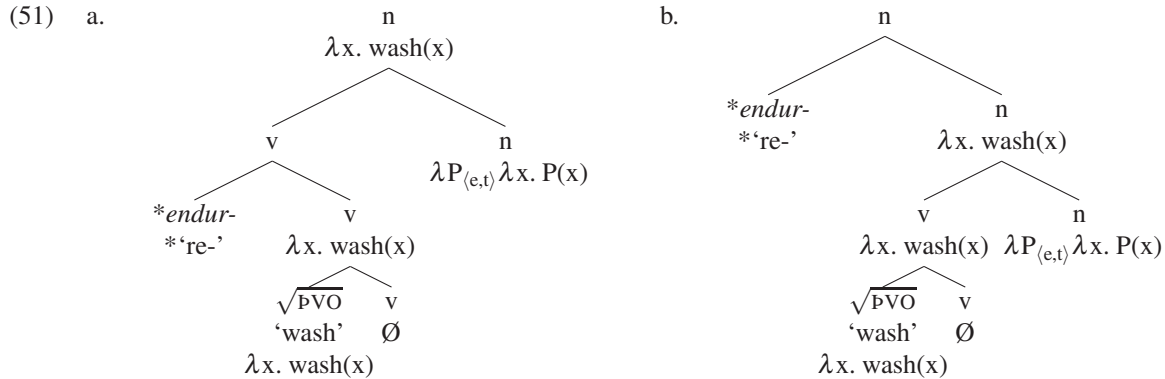

We can now understand why *endur-* or *re-* is possible for RNs that are computed from events, such as with result nouns that are built semantically off of a prior event, as discussed above. Consider (52), repeated from (47) above.

- (52) **Context**  
*Ég prentaði reglurnar fyrir hana í gær, en nú finnur hún ekki prentunina. Ég þarf að endurprenta reglurnar í dag.*  
*‘I printed the rules for her yesterday, but now she can’t find the print out. I need to reprint the rules today.’*  
*Ég vona að hún týni ekki endur-prent-un-inni.*  
 I hope that she loses not re-print-NMLZ-the  
 ‘I hope she doesn’t lose the reprinting.’

Here, *endurprentun* ‘reprint’ refers to the physical object, the piece of paper, that was produced in a reprinting event. Since this kind of RN reading may be built semantically off of a prior event, *endur-* is possible.

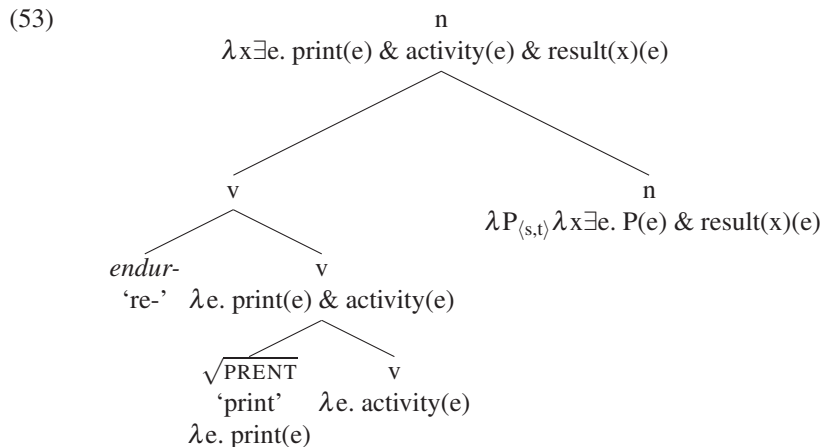

<sup>27</sup> This emphasis on the end state incorporates arguments from Marantz (2009a,b). The idea is that *re-* or *endur-* do not assert that the event took place again, just the end state holds again.

<sup>28</sup> At most, the meaning of  $v$  is a set of entities that can be described by the root  $\sqrt{\text{þVO}}$  ‘wash’, which may include events but also concrete entities like laundry.

Thus, *re-* may attach to *v* and pick out the result state of this event, before the event is nominalized into an RN.

Before moving on from this topic, I would like to revisit a question raised earlier about the way that we derive the SEN reading. Recall that I am assuming that entity variables and event variables are distinct in the typing system, for combinatorial purposes, but that both kinds of variables can in principle pick out events in the model. That is, events are a subtype of entity, so entity variables can pick out events. I have adopted the proposal in Roy & Soare (2013, 2014) that SEN readings of nominals are type-theoretically entities. But as I pointed out earlier, there are at least two paths to this: we can start with the set of events, and from that refer to the set of entities that point to those events—SEN Reading 1—or we can start with the set of entities and from that refer to the subset of those entities that point to events—SEN Reading 2.

$$(54) \quad \llbracket n \rrbracket \leftrightarrow \lambda P_{\langle s,t \rangle} \lambda x \exists e. P(e) \ \& \ x = e \quad \text{SEN Reading 1}$$

$$(55) \quad \llbracket n \rrbracket \leftrightarrow \lambda P_{\langle e,t \rangle} \lambda x \exists e. P(x) \ \& \ x = e \quad \text{SEN Reading 2}$$

The facts revolving around the analysis of *marg-* ‘many’ and *endur-* ‘re-’ prefixation provide support for the second approach. Under the first approach, the event variable should be accessible to modification at the *v* level. But if that is the case, there is no reason that *marg-* prefixation should distinguish the CEN and SEN readings. There is also no reason that *endur-* and *marg-* should differ in this respect. According to the present proposal, *endur-* and *marg-* differ in that *endur-* may attach to *v* or *n*, while *marg-* may only attach to *v*.

In sum, I have argued that nominalizations suggest that *endur-* does not attach to a DP object directly, as previously proposed, but instead attach directly at the level of the complex head. This conclusion forces us to further conclude that the end state of change of state semantics is represented internal to the complex head, which has already been independently proposed in this work. We have also seen further support for the view that SEN semantics are not built on the eventive meaning of the verb, but are instead derived directly from a particular alloseme of the *n* head. Finally, we have seen that there are two types of RNs: those that are built semantically off of verbal meaning, and those that involve idiosyncratic negotiation of the semantics of the root and the *n* head. In the next section, I will provide further support for this last conclusion, by turning my attention to a class of verbs that can only form RNs built off of verbal meaning, not the idiosyncratic kind.

## 6.5 The absence of idiosyncratic RNs in *-væð-ing* nominals

There is a sense in which the present system seems to claim that deverbal nouns can mean almost anything. We have already seen that there are limits; if *v* is interpreted as eventive, then the meaning of the nominal cannot be idiosyncratic and must build on that meaning. Still, this proposal does seem to resemble the one in Borer (2013, 2014) or in many lexicalist accounts where an arbitrarily large structure can get a special, idiosyncratic “encyclopedia” entry. Borer and others have proposed that the Voice head, or more descriptively the external argument layer, is where idiosyncratic meaning is “fixed” (see also Harley & Stone 2013). In this section, I would like to draw on the results of the previous chapters to argue that the domain is in fact smaller than that, and fixed well below the Voice level, based on a case study of *-væða* verbs and their nominalizations. I argue that these verbs show a clear structural limit to the size of the domain where idiosyncratic meaning is determined. The domain is structurally defined, and it is fixed before any Voice head is introduced into the structure. More importantly for the present work—and independently of the size of the domain—the discussion that follows also shows that many result meanings should *not* be derived directly from eventive meanings by any kind of typeshifting operation on the resulting interpretation. Rather, a structural dependency is needed between the nominalizer and the root, something which follows from an allosemy account of such readings.

The case study in question centers on verbs that are formed with *-væða*. The use of *-væða* to form verbs has increased dramatically in the past 100 years (Jónsdóttir, 2005). The most frequent in RMH are (in order):



- (56)
- |    |                        |                 |
|----|------------------------|-----------------|
| a. | <i>einkavæða</i>       | ‘privatize’     |
| b. | <i>nútímavæða</i>      | ‘modernize’     |
| c. | <i>markaðsvæða</i>     | ‘commercialize’ |
| d. | <i>hlutafélagavæða</i> | ‘corporatize’   |
| e. | <i>rafvæða</i>         | ‘electrify’     |
| f. | <i>tæknivæða</i>       | ‘automate’      |
| g. | <i>tölvuvæða</i>       | ‘computerize’   |
| h. | <i>siðvæða</i>         | ‘moralize’      |

However, *-væða* is also very productive and supports hoards of neologisms. As a rough estimate, a RMH search of all lemmas ending in *væða* yielded 517 distinct word forms. Out of these, a total of 279 forms appear more than once.

- (57)
- |           |                           |
|-----------|---------------------------|
| 238 forms | appear only once          |
| 107 forms | appear 2 or 3 times       |
| 74 forms  | appear 4–10 times         |
| 98 forms  | appear more than 10 times |

These figures contain some false positives, and don’t account for the fact that each inflectional form counts as a distinct form. Nevertheless, they are indicative of a high level of productivity (Barker, 1998), as also shown by Jónsdóttir (2005). Some less frequent forms include *dísilvæða* ‘dieselize’, *ESB-væða* ‘EU-ify’ (EU = European Union), *gsm-væða* ‘GSM-ify’, *LED-væða* ‘LED-ify’, *náttúruvæða* ‘make more natural’, *útvarpsvæða* ‘radio-ize’, *pönkvæða* ‘punkify’. The class of *-væða* verbs thus includes highly frequent forms and highly novel forms. However, amidst their productivity, there also seems to be a conspicuous lack of lexical idiosyncrasy. This seems especially to be the case when one considers *-væðing* nouns derived from *-væða* verbs. The following generalizations about *-væða/-væðing* seem to hold:

- (58) Generalizations about *-væða* and *-væðing*
- PP complements of *-væða* verbs are compositional, never idiosyncratic
  - væðing* nouns never take “deverbal P-prefixing”
  - The meaning of *-væðing* nouns is always built on the meaning of a *-væða* verb
  - væða* verbs cannot select for ApplP

I will argue that these generalizations stem from the structure of *-væða* verbs, specifically that *-væða* verbs are compounds, with *-væða* as the head. More precisely, the root  $\sqrt{V\bar{A}E\bar{D}A}$  adjoins directly to a little *v* head to form a complex *v*.

- (59)
- $$\begin{array}{c} v \\ \diagup \quad \diagdown \\ \sqrt{V\bar{A}E\bar{D}A} \quad v \end{array}$$

The root here is meaningless, like the root of  $\sqrt{DO}$  in English *do*-support (Embick & Marantz, 2008). But it can be used to derive novel verbs by compounding, typically with a noun adjoining to it.<sup>29</sup>

- (60)
- $$\begin{array}{c} v \\ \diagup \quad \diagdown \\ n \quad v \\ \diagup \quad \diagdown \quad \diagup \quad \diagdown \\ \dots \quad n \quad \sqrt{V\bar{A}E\bar{D}A} \quad v \\ \sqrt{ROOT} \end{array}$$

If we assume with Gísli Harðarson (2016; 2017; 2018) that compounds must combine elements of the same structural size—what he refers to as the **Matching Condition**—then this treatment of *-væða* entails that it will only be able to attach to categorized words, not roots:

<sup>29</sup> If other categories can adjoin to it, it would not change the major claims I make here; see discussion below.

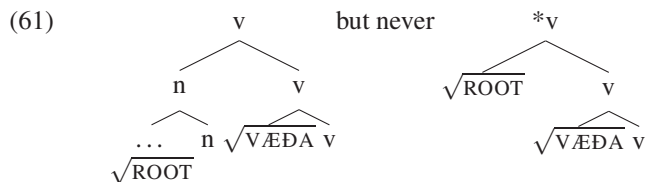

The structure in (60), taken along with the other claims in this work, has a cascade of consequences. The root will not be able to idiosyncratically select complement PPs for the reasons discussed in chapter 4: in short, it is too far away, with two phase heads intervening between it and the P. Given this, it also will not have deverbal P-prefixing, given the relationship between those two phenomena argued for in chapter 4. It will also not be able to select for an ApplP complement of v, so *-væða* verbs will not form double object constructions. Finally, the meaning of any *-væðing* noun derived from a *-væða* verb will always be compositional. Demonstrating why this last result holds requires a bit more discussion, but the gist of it is this. The structure of the compound is automatically interpreted in a way that forces the nonhead to get an interpretation before the verb is nominalized. Non-compositional interpretations of deverbal nominals, however, require that the root interpretation *not* be fixed at the stage where the verb is nominalized. This never holds for *-væða* verbs, because the structure does not allow it.

### 6.5.1 *-væða* attaches to categorized words

The claim that *-væða* attaches to categorized words and not to roots is supported by at least three considerations: (a) the possibility of categorizing morphology in the non-head/stem, (b) the existence of genitive-inflected stems, and (c) the general productivity of the formation.

First, it is important to note that the stem may itself show overt categorizing morphology. This is shown by the attested examples of *-væða* verbs in (62) and *-væðing* nouns in (63) (all taken from the RMH corpus).

- (62) a. að versl-**un**-ar-væða heilbrigðisþjónustuna  
to shop-NMLZ-GEN-væða health.care.service.the.ACC  
'to shopify the health care service'
- b. að lögfræð-**ing**-s-væða allt ríkiskerfið  
to lawyer-NMLZ-GEN-væða whole Establishment.the  
'to make the establishment more centered on lawyers'
- c. að hryll-**ing**-s-væða íslenskan veruleika  
to horror-NMLZ-GEN-væða Icelandic reality  
'to make Icelandic reality seem more horrifying than it really is'
- d. að sjúk-**ling**-a-væða hana  
to patient-NMLZ-GEN-væða her  
'to make her seem more sick than she really is'
- e. að eig-**end**-a-væða samvinnufélög  
to owner-NMLZ-GEN-væða cooperative.societies  
'to make co-ops more centered on the owners'
- f. að leiðbein-**end**-a-væða skólana  
to instructor-NMLZ-GEN-væða school  
'to reorganize the school system so that you have more unqualified teachers'
- (63) a. stofn-**an**-a-væð-ing  
office-NMLZ-GEN-væða-NMLZ  
'institutionization'
- b. upplýs-**ing**-a-væð-ing  
inform-NMLZ-GEN-væða-NMLZ  
'informationization'

- c. ljósleið-**ar**-a-væð-ing-ar  
 fiber.optic.cables-NMLZ-GEN-væða-NMLZ-PL  
 ‘fiber-optic-cable-izations’
- d. ál-bræð-**slu**-væð-ing  
 aluminium-melt-NMLZ-væða-NMLZ  
 ‘to do aluminium smelting on a larger scale’

The robust existence examples of this kind does not guarantee that *-væða* always attaches to a full, categorized word; but it does demonstrate that it *can* attach to a full, categorized word. In contrast, verb-forming suffixes like *-ka*, *-ga* or *-na*, as far as I know, never attach to stems with overt categorizing morphology. While it is common to say that *-ka* or *-na* form verbs from *adjectives*, it seems at best that these are *adjectival roots*—roots that normally form adjectives—not fully categorized adjectives. For example, we get *blíð-ka* ‘make calm’, *dýp-ka* ‘deepen’, *blá-na* ‘turn blue’ and *gul-na* ‘turn yellow’, but not *\*ró-legra-ka* ‘make peaceful’ or *\*druslu-legra-na* ‘become shabby’ (where *-legra* is a form of the adjectivizing suffix *-legur*). Similarly with *-ga*, which is said to form verbs from nouns, we never find overt nominalizing morphology inside a *-ga* verb. For example, we get *ryð-ga* for ‘rust’ but not *\*tær-inga-ga* ‘corrosionize’ (where *-inga* is a form of the nominalizing suffix *-ing*).

Second, the stem in *-væða* verbs can take inflection as a genitive, with some variation as to whether it is singular or plural, which is exactly what we see in compounds.<sup>30</sup> Like with compounds, the variation with *-væða* between singular and plural genitives, and the presence or absence of inflection, does not seem to correlate in any consistent way with the interpretation of the result, according to Jónsdóttir (2005). Here again, this pattern is distinct from other verb-forming suffixes. Suffixes like *-ka*, *-na* and *-ga* never (as far as I know) attach to stems that have compound-like genitive inflection. For example, we find *ryð-ga* ‘rust’ but not *\*ryðs-ga*, *líf-ga* ‘revive’ but not *\*lífs-ga* or *\*lífa-ga*, *blóð-ga* ‘cut’ but not *\*blóðs-ga*.

Finally, as mentioned above, verb formation with *-væða* is highly productive, with many novel forms being coined, and even applying to loan words, abbreviations, other compounds, etc., as we see throughout this section. This is also predicted if it attaches to fully categorized words, but not if it attaches (only) to roots.

The evidence discussed in this section strongly supports the view that *-væða* can attach to fully categorized word. It is harder to show for certain that it cannot also attach to roots. However, we might turn the question on its head and ask what kind of evidence would show that it *can* attach to roots. Within the present framework, the strongest evidence would be fully unpredictable meanings derived from *-væða* verb formation, or especially, of their nominalizations. And it is exactly this kind of evidence that I argue, in this section, cannot be found. I turn next to the interpretation of PP complements, which also supports the claim that *-væða* verbs are always built off of categorized words, and not category-neutral roots.

### 6.5.2 PP complements are compositional

In chapter 4, I discussed a number of cases where PP complements are non-compositional. I argued that in such cases, no more than one phase head can intervene between the root and the complement, which explains (assuming the complex head analysis) why such non-compositional PP complements cannot be inherited by deverbal nominalizations (and instead require prefixing). To illustrate with an example from that discussion, the verb *gera* ‘do’ can take a PP complement headed by *við* ‘with’, and take on the idiosyncratic meaning ‘repair’. This shows that idiosyncratic meaning can be conditioned between the root of a verb and its PP complement. However, when *gera* ‘do’ is nominalized as *gerð*, this derived noun cannot take the PP complement and still mean ‘repair’.<sup>31</sup>

<sup>30</sup> This kind of genitive stem inflection also shows up with other apparent cases of derivational morphology, generally with derivational morphemes that have properties similar to compound heads in other ways as well (e.g. stress patterns), so it is not necessarily a knock-down argument. See various papers by Þorsteinn Indriðason (e.g. 1999; 2006; 2014) for extensive discussion.

<sup>31</sup> To get this meaning, the preposition must adjoin directly to the complex head, as discussed in chapter 4 and revisited in the next subsection.

## (64) P in Complement

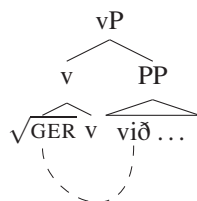

## (65) P in Complement

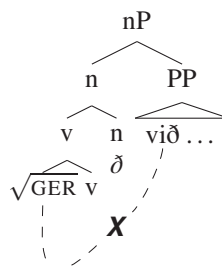

The prediction is that the same should hold in the other direction as well: if a categorized word is verbalized, it should not allow such idiosyncratic meanings.

## (66) P in Complement

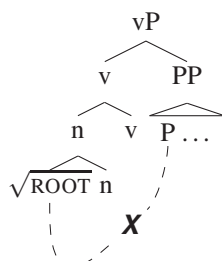

This prediction seems to be born out with *-væða* verbs: as far as I know, *-væða* verbs never take non-compositional or even semi-compositional PP complements. In fact, it is not clear to what extent *-væða* verbs take PP complements at all. The vast majority of PPs inside verb phrases headed by *-væða* verbs are clearly adjuncts. Even if some of them are truly arguments or complements, it is clear that their contribution to the verb meaning is fully compositional and predictable. This is illustrated with the attested examples in (67) (taken from the RMH corpus).

- (67) a. að útgerðarmenn eru búnir að **net-a-væða-st** fyrir vertíðina  
that ship-owners have finished to net-GEN-væða-ST for season.the  
'that ship-owners have already equipped themselves with nets for the season'
- b. að við værum að **hnatt-væða-st** í tryggum fjárhagslegum vexti  
that we were that globe-væða-ST in guaranteed financial growth  
'that we were globalizing ourselves in guaranteed financial growth'
- c. og flugvélar **net-væða-st** á ógnarhraða  
and airplanes internet-væða-ST on terrifying.speed  
'and airplanes connect to the internet with terrifying speed'
- d. að þessi býli [...] þarf að **raf-væða**  
that these farms [...] need to electricity-væða  
**með** mótorafrastöðvum eða **með** nýjum vatnsaflsstöðvum  
with motor-electric-stations or with new hydro.power.station  
'that these farms [...] need to be electrified with  
motor-electric-stations or with new hydroelectric stations'
- e. Þarna er búið að **vél-væða allt saman**  
there is finished to **machine-væða everything together**  
**með** einni bestu tækni sem þekkist í veröldinni.  
**with** one best technology that is.known in world.the  
'There they've mechanized everything with the best technology known in the world.'

Why should verbs formed with *-væða* be limited in this way? Notice that neologisms can easily take PP or particle complements (Barðdal, 2001a), so it cannot be explained away by saying that these verbs simply are "too new". The structure proposed in (60) (reproduced as part of (68) below) explains this.

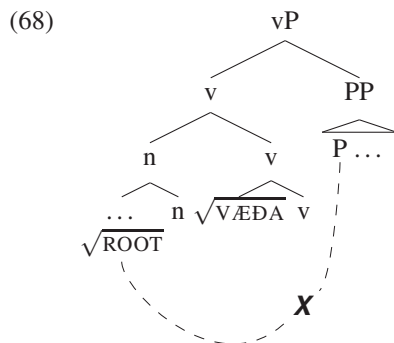

In order to select a P idiosyncratically, the root and the P would have to be visible to each other, but in fact, there are at least two phase heads intervening. The absence of idiosyncratic PP complements follows, specifically, from the claim that *-væða* verbs are always outer-attaching, and never root-attaching. The compounding analysis provides a principled reason for *why* they are not root attaching: they are compounds, and as such, subject to the Matching Condition, which forces the combination to be restricted to fully categorized words.

This constraint on locality also explains another generalization about *-væða* verbs: they are never double-object construction verbs. I have found no examples where a *-væða* verb takes two DP objects, and I have been unable to construct any examples that native speakers find acceptable—even in the NOM-DAT-ACC case frame, which is the most common case frame for Icelandic ditransitives. According to the theory of applicatives (Pylkkänen, 2002, 2008), double object constructions are derived when an ApplP inside the verb phrase introduces an extra argument into its specifier. However, Icelandic has been argued to be very limited in its applicative system: according to Wood (2015), it only has low applicatives, and its low applicatives are selected on a verb-by-verb basis. Even in English, non-selected beneficiaries can be more or less freely added to creation verbs such as *bake*, and this is true of other Scandinavian languages as well, including the very closely related language Faroese (Tungseth, 2007). Icelandic has benefactive datives, but they are only selected by particular verbs, not freely added (Maling, 2002b). This suggests that in Icelandic, individual roots must be in an idiosyncratic, listed, selectional relationship to ApplP. If so, then we correctly predict that *-væða* verbs cannot be ditransitive: the root is too far away from the complement of v to have a direct, c-selectional effect on that complement.

(69) **ApplP cannot be the complement of a *-væða* verb**

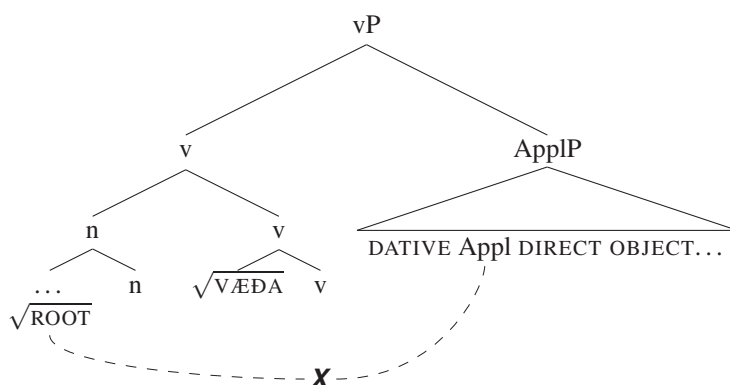

### 6.5.3 No “deverbal P-prefixing” in *-væðing* nouns

Connected with the above, when a *-væða* verb is nominalized as a *-væðing* noun, we do not, as far as I have been able to determine, find deverbal P-prefixing. In a search of the RMH corpus, I looked for all nouns where the lemma ends in *-væðing* and the word begins with *um* ‘about’, *út* ‘out’, *inn* ‘in’, *yfir* ‘over’, *á* ‘on’, *við* ‘with’, *að* ‘to’, *af* ‘from’, *í* ‘in’, all very common prepositions in P-prefixing structures. All the examples, as far as I can tell, involve a P element which is either part of a larger compound attached to the derived noun (thus not connected with the verb) (as in *uppgerðar-[tækni-væðing]* ‘fake/forced technologization’ or *ávísana-[einka-væðing]* ‘check privatization’), or are

part of the (usually nominal) non-head/stem, and thus also not connected with the verb directly, as in the examples in (70).

- (70)
- |    |                               |                                         |
|----|-------------------------------|-----------------------------------------|
| a. | <i>ábyrgðar-væðing</i>        | ‘(financial) guarantees’- <i>væðing</i> |
| b. | <i>aðstoðarmanna-væðingar</i> | ‘assistant’- <i>væðing</i>              |
| c. | <i>áskriftar-væðing</i>       | ‘subscription’- <i>væðing</i>           |
| d. | <i>frásagnar-væðingu</i>      | ‘narrative’- <i>væðing</i>              |
| e. | <i>fráveitu-væðing</i>        | ‘sewerage’- <i>væðing</i>               |
| f. | <i>ímyndar-væðingu</i>        | ‘image’- <i>væðing</i>                  |
| g. | <i>íþróttar-væðing</i>        | ‘sports’- <i>væðing</i>                 |
| h. | <i>umferðarljósa-væðing</i>   | ‘traffic light’- <i>væðing</i>          |
| i. | <i>umhverfis-væðing</i>       | ‘environmental’- <i>væðing</i>          |
| j. | <i>umhyggju-væðingu</i>       | ‘care/attention’- <i>væðing</i>         |
| k. | <i>uppákomu-væðing</i>        | ‘chance event’- <i>væðing</i>           |
| l. | <i>upplýsinga-væðing</i>      | ‘information’- <i>væðing</i>            |
| m. | <i>viðburða-væðing</i>        | ‘event’- <i>væðing</i>                  |
| n. | <i>viðskiptabanka-væðingu</i> | ‘commercial bank’- <i>væðing</i>        |
| o. | <i>viðskipta-væðing</i>       | ‘business’- <i>væðing</i>               |
| p. | <i>yfirdráttar-væðingu</i>    | ‘overdraft’- <i>væðing</i>              |

The lefthand stem of each of these forms is an independently existing noun, fully formed independently of *-væða*. For example, *upplýsingar* ‘information’ is a complex, derived form; but speaking to the present point, the fact that it contains the P-prefix *upp* has nothing to do with the formation of the *-væða* noun *upplýsinga-væðing* ‘informationization’.

Many *-væðing* nouns on the search do take the prefix *af-*, but this is not part of the phenomenon of P-prefixing as described in chapter 4. Firstly, this use of *af* is connected with the underlying verb, so the structure would be (71), or more accurately, according to the present proposal, (72).

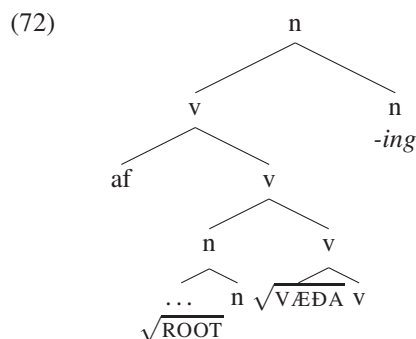
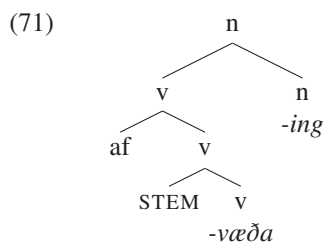

Secondly, this *af* isn't really the “prepositional” one, but is more like a reversative or negative prefix, along the lines of *de-* or *dis-* in English (e.g. *af-nýlendu-væðingar* ‘decolonization’, *af-glæpa-væðing* ‘decriminalization’). Some attested examples from the search are shown in (73).

- (73)
- |    |                            |                                  |
|----|----------------------------|----------------------------------|
| a. | <i>af-borgar-væðingu</i>   | NEG-‘city.GEN’- <i>væðing</i>    |
| b. | <i>af-einka-væðing</i>     | NEG-‘private’- <i>væðing</i>     |
| c. | <i>af-evru-væðing</i>      | NEG-‘euro.GEN’- <i>væðing</i>    |
| d. | <i>af-iðn-væðing</i>       | NEG-‘industry’- <i>væðing</i>    |
| e. | <i>af-klám-væðingu</i>     | NEG-‘pornography’- <i>væðing</i> |
| f. | <i>af-McDonalds-væðing</i> | NEG-‘McDonalds’- <i>væðing</i>   |
| g. | <i>af-Stalín-væðingar</i>  | NEG-‘Stalin’- <i>væðing</i>      |

|     |                               |                                         |
|-----|-------------------------------|-----------------------------------------|
| h.  | <i>af-stofnana-væðingar</i>   | NEG-‘institution.GEN’- <i>væðing</i>    |
| i.  | <i>af-Sukarno-væðing</i>      | NEG-‘Sukarno’- <i>væðing</i>            |
| j.  | <i>af-efnis-væðing</i>        | NEG-‘material.GEN’- <i>væðing</i>       |
| k.  | <i>af-geimveru-væðingu</i>    | NEG-‘alien.GEN’- <i>væðing</i>          |
| l.  | <i>af-kirkju-væðing</i>       | NEG-‘church.GEN’- <i>væðing</i>         |
| m.  | <i>af-kjarnavopna-væðingu</i> | NEG-‘nuclear.weapon.GEN’- <i>væðing</i> |
| n.  | <i>af-lýðræðis-væðingu</i>    | NEG-‘democracy.GEN’- <i>væðing</i>      |
| o.  | <i>af-manneskju-væðing</i>    | NEG-‘human.being.GEN’- <i>væðing</i>    |
| p.  | <i>af-nýlendu-væðingar</i>    | NEG-‘colony.GEN’- <i>væðing</i>         |
| q.  | <i>af-persónu-væðingu</i>     | NEG-‘human.GEN’- <i>væðing</i>          |
| r.  | <i>af-refsi-væðing</i>        | NEG-‘punishment’- <i>væðing</i>         |
| s.  | <i>af-reglu-væðing</i>        | NEG-‘rule.GEN’- <i>væðing</i>           |
| t.  | <i>af-kolefnis-væðing</i>     | NEG-‘carbon.GEN’- <i>væðing</i>         |
| u.  | <i>af-sið-væðing</i>          | NEG-‘civil’- <i>væðing</i>              |
| v.  | <i>af-stofnana-væðing</i>     | NEG-‘institution.GEN’- <i>væðing</i>    |
| x.  | <i>af-vopna-væðing</i>        | NEG-‘weapon.GEN’- <i>væðing</i>         |
| z.  | <i>af-þjóða-væðing</i>        | NEG-‘nation.GEN’- <i>væðing</i>         |
| a’. | <i>af-glæpa-væðing</i>        | NEG-‘crime.GEN’- <i>væðing</i>          |
| b’. | <i>af-kjarna-væðingu</i>      | NEG-‘nuclear.GEN’- <i>væðing</i>        |
| c’. | <i>af-klíku-væðingu</i>       | NEG-‘clique.GEN’- <i>væðing</i>         |

Thus, after extensively searching, we find no evidence that the phenomenon of deverbal P-prefixing exists among deverbal *-væða* verbs. Why should this be?

The answer at this point should be fairly clear. In the previous section we provided evidence showing that PP complements of *-væða* verbs are always compositional—there are no cases (that we have found) of special meaning arising from the combination of a *-væða* verb with a particular preposition. Since P-prefixing occurs precisely to ensure that the preposition is visible to the root for conditioning of special meaning, it is therefore not surprising that this phenomenon does not occur with *-væðing* nominalizations. The meaning of *-væða* verbs is never conditioned by a preposition, which means that P-prefixing is entirely unnecessary. That is, these are two sides of the same fact, and in fact, the absence of deverbal P-prefixing further supports the empirical claim in the previous subsection that there are no idiosyncratic PP complements of *-væða* verbs; searching for P-prefixing *-væðing* nouns is one way to look for such cases, but in fact, they are nowhere to be found.

#### 6.5.4 Meaning of *-væðing* nouns is built on verb meaning

As is well known, and much discussed throughout this work, nominalizations of verbs in general do not have to build on verbal, eventive meaning; they can “go their own way”. For example, *minnkun* can mean ‘shame/disgrace’ in a way that does not (necessarily) stem from the verb *minnka* ‘decrease’, *lítillækkun* can mean ‘humiliation’ for some speakers, even if they do not allow this meaning with a verb such as *lítillækka*. Many more examples of this are discussed throughout this book. As far as I know, however, *-væðing* nouns do not do this; they always contain eventive meaning connected with the meaning of the verb they are derived from. They can have a CEN reading, or refer to the event itself, the process associated with such events, or perhaps to the state that results from the event. But the verbal event is always there, in the meaning.

- (74) a. *vegna vél-væðing-arinnar*      á sveitabæjunum  
       due.to machine-væðing-the.GEN of farms  
       ‘due to the mechanization of farms’
- b. *af einka-væðingu*      á starfsemi af þessu tagi  
       by private-væðing.DAT of work      of this kind  
       ‘by privatization of work of this kind’
- c. *raf-væðing*      á girðingum  
       electric-væðing of fences  
       ‘electrification of fences’

In addition to building on and containing the verb's eventive meaning, the result is predictable. To illustrate the distinction, the noun *hreinsun*, derived from the verb *hreinsa* 'clean', can be used as a location (as in *fatahreinsun* 'dry cleaner/laundromat'). In this use, it may contain the meaning of *hreinsa* (or it may not; I make no particular claims at this point). But even if it does, the overall result is unpredictable; we do not normally expect to nominalize a verb and get the meaning of 'location where this action takes place'. This has to be listed/learned separately. As we have seen elsewhere, when the otherwise similar verb *þvo* 'wash' is nominalized as *þvottur*, it does not have this location meaning; it refers to the event itself or the material being washed. This difference between the nominalizations of *þvo* 'wash' and *hreinsa* 'clean' has to be listed, whether the result seems to contain the same basic root meaning or not. Similarly, *marinering* can refer to 'marinade', the stuff used in events named by the verb *marinera* 'marinate'. Perhaps the nominal *marinering* 'marinade' contains the verbs meaning (or perhaps not); but either way, it is not predictable. One does not generally expect that nominalizing a verb will provide an 'instrument' or 'material used' meaning. But this kind of idiosyncratic meaning does not, as far as I know, show up with *-væðing* nouns.

- (75) a. *rafvæðing* 'electrification' cannot refer to the wires used to transmit electricity, or the location where electricity is transmitted.  
 b. *einkavæðing* 'privatization' cannot refer to a material (or an "abstract instrument"), or to the office where one files 'privatization' documents.  
 c. *vélvæðing* 'mechanization' cannot refer to the supplies you buy at the store in order to *vélvæða* your farm.

Why can't *-væðing* nouns have the whole range of relations to the underlying verb that other deverbal nouns can have? Should we be surprised by the absence of idiosyncratic meaning? It turns out that according to the thinking in much recent research, this is in fact surprising. In much work in DM and related frameworks (see e.g. Alexiadou (2017a)), deverbal nominalizations are idiosyncratic when they are "Result Nominals" (RNs), which happens when they are root attaching. This fits the facts here in that *-væðing* nouns are not root attaching, and indeed are not idiosyncratic. So far, so good. However, *-væðing* nouns are not all Complex Event Nominals, as this view would lead us to think, and can in fact be Result Nominals, even though they are not root attaching. So the question becomes how to interpret *verb-derived* (rather than root-derived) RNs. In Borer (2012; 2013; 2014), all RNs involve the absence of aspectual structure, which allows for a special search of the encyclopedia, and thus, idiosyncratic semantics. This is similar to various lexicalist approaches in at least this one respect (see e.g. Lieber (2017)). Alexiadou (2009) acknowledges that RNs can be v-attaching, but claims that they must be semantically compositional. This, too, accords very closely with the facts here connected with *-væðing* nouns, but not with the other examples discussed in this work (e.g. *minnkun* 'disgrace'), where verb-derived nominalizations do get idiosyncratic meanings.<sup>32</sup> Harley (2009b) also acknowledges that RNs can be built on categorized verbs (vPs, for her), but there is no distinction between idiosyncratic and compositional RNs. Essentially there is a choice between taking an argument (CENs) or getting a "count" reading (RNs), which is similar to Alexiadou's (2009) proposal, but does not involve a restriction to compositional cases. To sum up, most approaches to date either allow any deverbal nominal to get an idiosyncratic meaning, or force all "truly deverbal" nominalizations to be compositional. This is at odds with the situation we seem to find here, where not all truly deverbal nominalizations are compositional, but all *-væðing* nouns are.

### 6.5.5 *The interpretation must be compositional*

In this section I discuss in more detail why the interpretation of *-væðing* nouns must be compositional. To put it another way, the question I am addressing is whether nouns with a structure like (76a) can have types of meanings that nouns with a structure like (76b) cannot.

<sup>32</sup> That is, the present system allows idiosyncratic meanings even when v-attaching, as long as v is semantically  $\emptyset$ . Such examples seem to exist, but are predicted not to by the system in Alexiadou (2009).



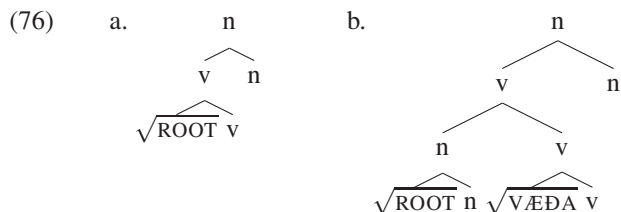

I have claimed that for (76a) to have an idiosyncratic meaning, *v* must be semantically  $\emptyset$ . Following this line of thinking, if the more complex *-væðing* structure is to have even a chance of doing the same thing, the *v* head,  $\sqrt{VÆÐA}$ , and the lower *n* head must all be semantically expletive. I propose that this is impossible, even if we put aside phase-based concerns about a relationship between the root and the highest *n* head.<sup>33</sup>

Following a long line of work on attributive compounds, Ingason & E.F. Sigurðsson (2020) have proposed that such compounds are interpreted with a special set of relations between the head and the non-head. They make the novel proposal that this happens because an extra node is inserted postsyntactically in the semantics, attached to the non-head.<sup>34</sup> Adapting that here, we could have the schematic rule in (77), where  $R_{\text{RELATION}}$  would be interpreted as (78):

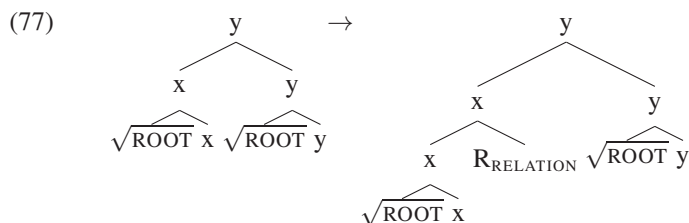

(78)  $\text{RELATION}(x,y)$  (“RELATION holds between *x* and *y*”)

This would mean that in the case of *-væða* verbs, both the non-head (the noun) and the head (the verb) would have to get an interpretation, because there must be a relation between them.

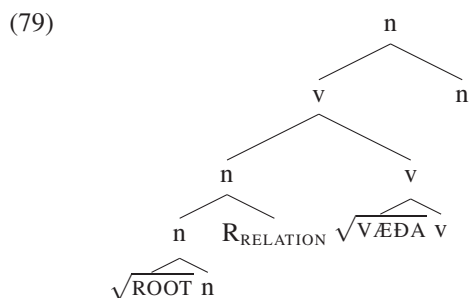

(80)  $\text{RELATION}(n,v) = \text{“RELATION holds between } \llbracket n \rrbracket \text{ and } \llbracket v \rrbracket \text{”}$

Now, even if we allowed the *n* of the non-head to be semantically  $\emptyset$ , the root would have to get an interpretation to be part of the relation. Moreover, I have claimed that the root  $\sqrt{VÆÐA}$  itself is meaningless—if that claim is right, it entails that *v* cannot be semantically  $\emptyset$ . If that claim is wrong, then at least  $\sqrt{VÆÐA}$  would have to have a meaning. That is, *something* within the verb has to have a meaning, in order for that meaning to be part of the relation. The result is that both parts must get a meaning, so no idiosyncratic relationship between the root and the nominalizing *n*-head would ever be able to obtain.

<sup>33</sup> It is actually entirely possible that, for principled reasons, a structure like  $[[[\sqrt{\text{ROOT}} n] v] n]$  would not allow interaction between the highest *n* and the root, even if the intervening *n* and *v* heads were null. I set this issue aside, because I believe that the situation at hand has a different explanation, along the lines of the discussion in the main text.

<sup>34</sup> This is an instance of what Choi & Harley (2019) call ‘Node Sprouting’ and is otherwise called Dissociated Node Insertion (Embick, 1997), but unlike typical cases, where it happens at PF for morphological well-formedness reasons, it happens at LF for semantic well-formedness reasons. Note that Eik (2019) has a similar structure, with similar semantics, but proposes that it attaches in the syntax, and is sometimes realized in PF as a linking element.

Anton Karl Ingason (p.c.) points out that compounds may get somewhat idiosyncratic or at least unpredictable meanings, even in cases where they seem to combine two categorized parts.<sup>35</sup> Ingason & E.F. Sigurðsson (2020) argue that the basic, structural meanings of compounds computed by the finite set of RELATIONS can be affected by “Contextual Domain Restriction” (CDR), and that this is where world knowledge can make the precise meaning of a compound *seem* somewhat idiosyncratic. The question that arises is whether the *-væða* verb itself can be idiosyncratic in this way, and furthermore whether the *-væðing* noun derived from the *-væða* verb can use this mechanism to get an idiosyncratic meaning not built on the meaning of the *-væða* verb.

I argue that these possibilities for *-væða* verbs are actually quite limited. To the extent that we find them, they cannot extend to nominalized *-væða* verbs; however the meaning of a *-væða* verb is obtained, a *-væðing* noun will be built from that meaning, and not some new idiosyncratic meaning. First, since the root  $\sqrt{VÆÐA}$  is itself meaningless, *v* will get a predictable structural meaning. So there is not much room for world knowledge to affect the relation between the two parts, when one part is essentially functional and not lexical. Still, we will see below that there may be some effects like this, related to the non-head. Nevertheless, it seems to hold that the non-head must get a fixed interpretation, and this is the important point here.

Second, as mentioned above, the *-væðing* noun will still have to build on this meaning; the *n* head that combines with the *-væða* verb will not be able to affect it, or—crucially—make meanings available that would not otherwise be available. Consider why. We have already seen that *v* cannot be zero, and that both parts of the *-væða* verb must be interpreted. This means that the allosemes available to *n* are quite limited. *n* can be  $\emptyset$ , forming a CEN, or it could be a Result. But these kinds of meanings are not going to alter the world knowledge associated with an event. The most that we might expect to find is that the notion of ‘result’ may be different for different events, depending on world knowledge. But this is just the ordinary process of interpreting *n*, as discussed elsewhere in this work—it is not something that creates an idiosyncratic meaning for the whole structure that does not depend on the meaning of the verb contained within it. In the next subsection, I will turn to the actual interpretation of the *-væða* verbs themselves.

### 6.5.6 The interpretation of *-væða* verbs

So far, I have not said exactly what the interpretation of a *-væða* verb is, only that the complex *v* head (either the root or the *v* head or both) has to have *some* interpretation. (That is, it cannot be an expletive *v* head and expletive root.) Based on what is proposed so far, this is a matter of determining the meaning of the relation, as well as the head. I assume that the non-head in general gets the same meaning it would normally get outside of its occurrence in a *-væða* verb.

Jónsdóttir (2005, 109) proposes that there are four kinds of meanings for *-væða* verbs, and says that the vast majority of *-væða* verbs fall into the following two categories.<sup>36</sup>

- (81) a. *búa, útbúa með, gæða* ‘equip, endow/provide with’
- i. *ljósvæða* ‘illuminate, provide with light’
  - ii. *tækjavæða* ‘provide with equipment, tools’
  - iii. *bílvæða* ‘motorize, provide with cars’
  - iv. *vopnvæða* ‘weaponize, provide with weapons’
- b. *breiða út, gera X-legt* ‘spread, make X-like’ (X = non-head of compound)
- i. *alþjóðavæða* ‘internationalize, make international, spread across all nations’
  - ii. *hnattvæða* ‘globalize, make global, spread across the globe’
  - iii. *evrópuvæða* ‘make European, spread across Europe’
  - iv. *nútímavæða* ‘modernize, make modern, spread the present time’

<sup>35</sup> I believe that the extent to which this is true requires further research, however, since most work on compounding has not until recently distinguished between compounds combining two roots and compounds combining two categorized heads.

<sup>36</sup> The less frequent categories that she discusses are:

- (i) *búa til, gera að e-u* ‘create, turn into something’
- (ii) *gera háð e-u* ‘depend on something’

One could try a number of relations to interpret the compound and get the facts more or less right. I would like to suggest one kind of possibility that might capture what is going on with a large number of them. Suppose as a first approximation that we take the ‘provide with’ paraphrase seriously. The complex *v* head denotes an event of providing,<sup>37</sup> the noun denotes the noun, and the relation between them is WITH—a kind of *have* relation (see Levinson 2011; Myler 2014, 2016).

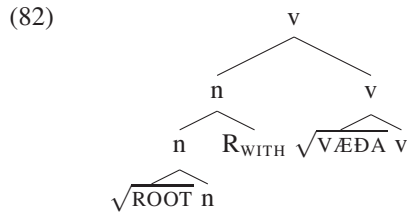

This gets the first group easily, of course; *ljósvæða* means ‘provide with light’, *tækjavæða* means ‘provide with equipment’, etc. But the second group is not so straightforward. *Evrópuvæða* ‘Europe-ize’ does not mean ‘provide X with Europe’, *hnattvæða* ‘globalize’ does not mean ‘provide X with the world/globe’. One strategy would be to suppose that there is a different relation for those cases. But suppose instead that what goes wrong here is that in these cases, the noun is not interpreted in the normal way. Instead, what we want is something like ‘the characteristic properties of the noun’. So we end up with X-*væða* meaning ‘cause X to have the characteristic properties of the noun’.<sup>38</sup> This, then, might fall under the notion of what Ingason & E.F. Sigurðsson (2020) refer to as Contextual Domain Restriction in the area of compound meaning. Whether *ljósvæða* ‘illuminate’ means ‘provide X with light’ or ‘provide X with the characteristic properties of light’ has to do with our broader world knowledge of what the relationship is between light and X, and the same goes for the other examples. In particular cases this can change over time. The ‘original’ *-væða* verb (the etymological source of *-væða* in its current use) was *hervæða*, which now means ‘militarize’; but originally it meant ‘provide X with armor’. The general process of lexical broadening was a product of the loss of lexical meaning on *-væða* (it no longer synchronically meant ‘clothes’), so it came to be understood as ‘provide X with the characteristic properties of the army’, which may, but need not include military clothing.

An interesting case in point comes from some attested examples of *vopnvæða* ‘weaponize’. (83a) comes from a translation of the English word ‘weaponize’, in the context where Trevor Noah of the *The Daily Show* stated that Donald Trump weaponized victimhood—turned the notion of victimhood into a weapon.<sup>39</sup> In this case, the meaning is clearly closer to ‘providing victimhood with the characteristic properties of weapons’ (making victimhood itself a weapon, or something like it). In (83b), however, the meaning is closer to ‘providing the police with weapons’.

- (83) a. *vopn-væða fórnarlambsvæðingu*  
 weapon-*væða* victimhood  
 ‘weaponize victimhood’  
 (causing victimhood to have the characteristic properties of weapons; e.g. dangerous, can be used to attack and cause damage, etc.)
- b. *vopn-væð-ingu lögreglunnar*  
 weapon-*væða*-NMLZ police.the.GEN  
 ‘weaponization of the police’  
 (causing the police to have more weapons)

This kind of effect of the non-head and context/world knowledge is on par with Ingason & E.F. Sigurðsson’s (2020) discussion of ‘elephant gun’ meaning ‘gun FOR elephants’, but world knowledge telling us that this FOR relation is really ‘gun FOR shooting elephants’. If we coin a compound like *soldier gun*, we would readily understand it as a ‘gun FOR soldiers’, but not as a ‘gun FOR shooting soldiers’ (at least not without substantial additional context).

<sup>37</sup> Probably an “event of providing” is too complex to be a primitive, but this will suffice for now.

<sup>38</sup> Or, sticking closer to the earlier paraphrase, ‘to provide X with the characteristic properties of the noun’.

<sup>39</sup> So, for example, men who felt at risk of being accused of sexual harassment or assault as part of the #metoo movement could claim to be victims of the movement, allowing them to ‘fight back’, even though the real victims are, of course, the accusers.

### 6.5.7 *-væða as its own verb*

I have not yet provided an explanation for why *-væða* cannot stand on its own as a verb. After all, the analysis here says that it is a verb—the head of a compound—and that it does contribute eventive meaning. So why is it not possible to say *væða X með Y* ‘provide X with Y’? I would like to suggest that part of this puzzle connects with verbs like *einkavæða* ‘privatize’ and *nývæða* ‘modernize’, discussed at length by Margrét Jónsdóttir (2005):

- (84) a. *einkavæða* ‘privatize’  
b. *nývæða* ‘modernize’

The puzzle stems from the fact that that *einka-* and *ný-* are generally prefixes—they also do not occur on their own.

- (85) a. *einka-barn* ‘an only child’, *einka-erfingi* ‘the sole heir’, *einka-líf* ‘private life’, *einka-skjal* ‘private document’, *einka-heimili* ‘private home’, *einka-hagsmunir* ‘private interests’, *einka-sjónarmið* ‘personal point-of-view’, *einka-afnot* ‘private use’, *einka-rekstur* ‘private management’, *einka-gróði* ‘private profit’, *einka-bústaður* ‘private (summer) house’  
b. *ný-guðfræði* ‘neo-theology’, *ný-íslenska* ‘New-Icelandic’, *ný-mál* ‘Newspeak (from a translation of George Orwell’s novel ‘1984’), *ný-myndun* ‘new-formation’, *ný-nasismi* ‘neo-nazism’, *ný-sköpun* ‘innovation’, *ný-slægja* ‘freshly cut grass’, *ný-yrði* ‘neologism’

But if they are prefixes and *-væða* is a suffix—what are the prefixes prefixing to, and what is the suffix suffixing to? The tentative answer here is of course that *-væða* is not really a suffix at all; it is a verb, and *einka-* and *ný-* prefix to that verb. That is, formally *-væða* is a verb, but there is something missing in this verb’s meaning. It needs something else, and usually that something else is the non-head, but it can also be these prefixes.

Or, it turns out, the missing part can be filled in by other things, like prepositional particles (examples from the RMH corpus):

- (86) a. Okkar aðal markmið er byggja upp hóp sem berst gegn **inn-væð-ingu** Islam á Íslandi.  
our main goal is build up team which fights against in-væða-NMLZ Islam.GEN in Iceland  
‘Our main goal is to build up a team which fights the incorporation of Islam in Iceland.’  
b. Koma afstofnavæðingunni og **inn-væð-ingu** geðsjúkra á almennan vinnumarkað...  
get deinstitutionalization and in-væða-NMLZ mentally.ill.GEN to general job.market  
‘Get deinstitutionalization and incorporation of the mentally ill to the job market...’
- (87) a. ...í bland við þá skefjalausu græðgi sem varð keikja Occupy hreyfingarinnar, sem og þá  
in mix with that limitless greed which became spark Occupy movement.GEN as and that  
plágu sem **uppa-væð-ing** hefur verið fyrir New York.  
plague which up-væða-NMLZ has been for New York  
‘...mixed with the limitless greed which sparked the Occupy movement, as well as the plague which  
gentrification has been for New York.’  
b. Af þessum ástæðum hefur miðstéttar-væð-ing stundum verið kölluð „**uppa-væð-ing**“ í  
from these reasons has middle.class-væða-NMLZ sometimes been called up-væða-NMLZ in  
hálfkæringi.  
half.heartedness  
‘For these reasons, gentrification (lit. ‘middle-class-ification’) has sometimes half-heartedly been called  
“uppvæðing”.’

For the time being, I must be unfortunately quite vague about what exactly *-væða* means, specifically in the sense of what is ‘missing’ such that it needs something else. One approach might be that it semantically requires two internal arguments or a small clause, but syntactically only selects for a single DP. Because of this, something else must be attached to the verb in order to get the intended meaning (much like a deverbal synthetic compound). Whatever the mechanism is, it seems clear that the verb denotes the instigation of a change, applied to the direct object, and the non-head or prefix describes that change. The examples discussed in this section support the idea that *-væða* is a verb in its own right, rather than a suffix, even if it cannot occur on its own.

### 6.5.8 Take-home points about *-væða* verbs

Icelandic *-væða* verbs and their *-væðing* nominalizations provide an interesting case study for the locality of idiosyncratic meaning. This is because in all cases discussed where one might expect special meaning to arise—PP complements, ApplP complements, P-prefixing, and RN nominalizations—it consistently fails to do so for verbs built with *-væða*. We can therefore be confident that the structure of *-væða* verbs, whatever it may be, is one which does not contain the appropriate locality conditions for the conditioning of idiosyncratic meaning.

I have argued that *-væða* is not the realization of a derivational *v* suffix, but is instead a distinct verb with its own root and little *v* head, which may seem to form new verbs by serving as the head of a verbal compound, as in (88).

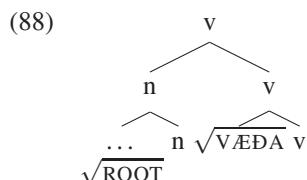

These results speak against the idea that nominalization is just derivation, and therefore its meaning can be listed and unpredictable. It also speaks against the idea that unpredictable result nominalizations are derived from eventive meanings by some kind of typeshifting operation. Rather, there are specific, formal constraints on just how unpredictable the meaning of a derived form can be, and the locality conditions for unpredictable meaning, conditions which are not met in nominalizations of *-væða* verbs. Since we already have reason to conclude that Icelandic nominalizations do not have a Voice head, we can also conclude that the locality restrictions on idiosyncratic meaning can be smaller than VoiceP.

## 6.6 The alloemes of n

We have now seen a wider range of alloemes for *n*. A basic inventory of the *n* head alloemes discussed is as shown in (89). We saw evidence for each of these in deverbal nominalizations.

|      |    |                                                                                                                                |                |
|------|----|--------------------------------------------------------------------------------------------------------------------------------|----------------|
| (89) | a. | $\llbracket n \rrbracket \leftrightarrow \lambda x_{\tau}. x$                                                                  | Null/Expletive |
|      | b. | $\llbracket n \rrbracket \leftrightarrow \lambda P_{\langle e,t \rangle} \lambda x \exists e. P(x) \ \& \ x = e$               | Simple Event   |
|      | c. | $\llbracket n \rrbracket \leftrightarrow \lambda P_{\langle e,t \rangle} \lambda x \exists s. P(x) \ \& \ x = s$               | Simple State   |
|      | d. | $\llbracket n \rrbracket \leftrightarrow \lambda P_{\langle e,t \rangle} \lambda x. P(x)$                                      | Simple Entity  |
|      | e. | $\llbracket n \rrbracket \leftrightarrow \lambda P_{\langle s,t \rangle} \lambda x \exists e. P(e) \ \& \ \text{result}(x)(e)$ | Result         |
|      | f. | $\llbracket n \rrbracket \leftrightarrow \lambda P_{\langle e,t \rangle} \lambda x \exists e. P(x) \ \& \ \text{place}(x)(e)$  | Location       |

There may be slightly different ways of achieving the same results. It is possible that the Simple Event and Simple State alloemes are not distinct alloemes, but distinct uses of a single alloeme. I have suggested that there is only one Result alloeme, and that this is responsible for the result state and product readings, among others. Similarly, I have proposed that the Simple Entity alloeme above is responsible for inanimate patient readings as well as any other non-Result readings that bear no clear relation to the underlying verb's argument structure. However, another possibility discussed was that further predicates, such as “material(*x*)” or “state(*x*)” might be added to the Result or Simple Entity alloeme.

What I have tried to emphasize, however, is a move away from thinking about RN and SEN readings in terms connected with the argument structure of the verb they are derived from. Instead, the relevant questions are as follows:

- Is the event variable present, and available for modification?
- Is eventive meaning compositional and predictable from the meaning of the verb?
- Is root-conditioned alloemy of *n* (potentially past *v*) necessary?
- Is *n*-conditioned alloemy of the root (potentially past *v*) necessary?

The first two questions have been argued to distinguish between Result readings and the other readings. Only with true Result readings is the meaning of the verb unchanged and the event variable available for word-internal modification. The third and fourth questions were argued to be the primary way of deciding whether a particular distinction needed to be encoded as allosemy of *n* or of a root. They are not always easy questions to answer. In order to determine, for example, that the product reading must be distinct from the result state reading (in contrast to what I have proposed), one must show that some root requires one or the other reading in a way that is not predictable from its semantics. But root semantics are so flexible in general that one really needs a robust set of near-minimal pairs, where the roots in each pair are very semantically similar otherwise but nevertheless pick different readings in a way that makes sense if they are choosing distinct allosemes of *n*. This was argued to be the case for location allosemes, for example. Even when the meaning is compositional, the availability of a location reading is not predictable, as far as I have been able to tell, from the semantics of the root. Therefore, the location alloseme of *n* must be conditioned by contextual allosemy by a memorized list of roots. Similarly, to propose that a root is subject to allosemy conditioned by *n*, one would have to show that the root makes a truly distinct contribution in the context of *n*, that does not plausibly stem from simple conceptual readjustments of a root's basic meaning in the context of a particular alloseme of *n*. As far as I know, distinctions of the relevant sort have not been subjected to such a study to date. I have tentatively proposed that roots may condition particular allosemes of *n*, but that *n* may not condition suppletive allosemes of the root.

## 6.7 Summary

In this chapter, I have discussed the readings that are traditionally identified as SEN and RN readings, or more broadly, the set of readings other than CEN readings. I have argued that this class of readings is defined by having a semantically contentful *n* head. This way of looking at it picks out a larger class of readings, which are subdivided into meanings that are built directly on root meaning, when *v* is semantically null, and readings that build on verbal meaning, when *v* is semantically contentful. I argued that the interaction between the root and *n* necessary mirrors the interaction we see in the phonology: *n* may interact directly with the root, but only if *v* is  $\emptyset$  semantically or phonologically. I argued that word internal modifiers, like verbal prefixes, can be used to identify a semantically contentful or semantically  $\emptyset$  *v*-head. When such prefixes force *v* to be semantically contentful, then the meaning of the nominalization is built off of the meaning of the verb. Another case that supported this point was *-væða* verbs, which have a compound structure that prevents *v* from being semantically  $\emptyset$ . Because of this, nominalizations of such verbs are correctly predicted to be built off of the meaning of the verb, and cannot be idiosyncratic. Finally, the discussion above emphasized that our understanding of the range of interactions between *n* and a root needs to be based primarily on cases where we are sure that *v* is present; the most straightforward evidence bearing on this is when *v* is morphologically overt. I would like to close the chapter, and thus the main part of the present study, on this point, because I believe this is a distinction that needs to be taken seriously at a fundamental level, no matter what one's theoretical framework is. If the empirical characterization of morphological generalizations is based solely on words with overt categorizing morphology, we may end up with a rather different theory than we would have when we assume that the word roots we are looking at have the categories that we think they have.

## Chapter 7

### Conclusion

In this book, I have aimed to bring a basic, but detailed description of Icelandic nominalizations to bear on the general theoretical and architectural issues that nominalizations have raised since the earliest work in generative syntax. While nominalization has long been central to theories of argument structure, and Icelandic has been an important language for the study of argument structure and syntax, Icelandic has not been brought into the general body of theoretical work on nominalization. I have shown that Icelandic-specific issues in the analysis of derived nominals have broad implications that go beyond the study of that one language. In particular, Icelandic provides special evidence that Complex Event Nominals (CENs), which seem to inherit their argument structure from the underlying verbs, can be formed without nominalizing a full verb phrase. This conclusion is at odds with prominent theories of nominalization which claim that CENs have the properties that they have precisely *because* they involve the nominalization of full verb phrases. Even if full verb phrases can be nominalized in some constructions and languages, the Icelandic facts are important because they show that the properties of CENs can arise even in the absence of verb phrase structure.<sup>1</sup>

Supporting the claim that Icelandic CENs are not derived from verb phrases was the primary objective of chapter 3, but it is something that shows up to some extent throughout the rest of this work. Chapter 4 is a special case of this, because the issues surrounding prepositional prefixing are complex enough to bear on several important points—including an additional argument against the analysis of Icelandic nominalizations as being derived from verb phrases. But there is another point emerging from chapter 4 that I would like to emphasize, and that is the fundamentally *syntactic* nature of word formation that I support in this book. The lexically idiosyncratic relationship between a verb and a preposition must meet certain locality constraints, but those constraints can be potentially met across a phrasal boundary or within a morphological word. I have assumed that the theory of phrase structure involves at least two structure-building mechanisms, one that yields complements (and possibly specifiers), and another that involves adjunction. This much is widely assumed (although not always celebrated), sometimes formalized as ‘Set Merge’ and ‘Pair Merge’. Given this, it is straightforward to assume that a head can adjoin to another head directly, and build complex heads in the syntax without necessarily building phrasal structure. While most of the book explores the consequences of this in the area of deverbal nominalization (and, to some extent, compounding), chapter 4 speaks strongly to the point that what we think of as lexical idiosyncrasy is defined over structures that are built in the syntax, which are sometimes phrasal, sometimes not.

While many of the broad empirical and theoretical conclusions hold well beyond the specific framework that I adopt in this book, I do also aim to (a) argue for a specific characterization of the architecture of grammar, that I hope should serve as a constraint on what a model of grammar should like, and (b) develop the theory of Distributed Morphology in a way that centers on this characterization. As for (a), the architecture of grammar seems to robustly support many-to-many relations between form and meaning. We find them over and over again, once we start looking for them, and in a way, they have always been center stage in the study of nominalizations. I believe that this should fall out as a fundamental feature of the architecture of grammar. As for (b), I have argued that the theory of allosemy—Late Insertion on the LF side—accounts for the ambiguity of nominalizations and inheritance of argument structure. More generally, an architecture of grammar with Late Insertion at both interfaces provides a principled explanation for the abundance of “many-to-many” mappings between form and meaning. Fleshing out the initial details of how such an architecture accounts for the range of readings found in deverbal nominalizations is the central task of chapters 5 and 6.

---

<sup>1</sup> I have, however, maintained that the presence of a verb is necessary—just not a verb phrase.

On an empirical level, I have discussed and proposed analyses for a variety of phenomena in the morphology, syntax and semantics of Icelandic verbs and nouns, including theme vowels, verbalizers, nominalizers, compounds, and various prepositional and non-prepositional prefixes. However, in all of these areas, there is still much more to be said and discovered, and there are many phenomena that I have barely alluded to, or not mentioned at all, that still await further investigation, both in general and within the specific theoretical lens of this book. For example, this study has focused on event nominalizations of verbs, but has only touched on agent nominalizations, or deadjectival nominalizations, and the general architecture makes strong predictions about other kinds of derivation, such as deverbal/denominal adjectives and denominal/deadjectival verbs. Moreover, there is much more to be said about Icelandic prefixing, both of the prepositional and non-prepositional kind. Nevertheless, while I feel I have really only scratched the surface of the empirical depth one will find in Icelandic in this area, I also feel that the picture that emerges so far is compelling enough to support the broader claims I have argued for throughout this work. My hope is that the future elaboration of the details of the execution of these claims, or even the successful or attempted refutation of them, will provide a path toward a deeper understanding of this area of the language faculty in general, as it manifests in Icelandic and other languages in particular.



## References

- Abney, Steven Paul. 1987. *The Noun Phrase in its Sentential Aspect*: MIT Doctoral dissertation.
- Acedo-Matellán, Víctor. 2010. *Argument Structure and the Syntax-Morphology Interface: A Case Study in Latin and Other Languages*: Universitat de Barcelona Doctoral Dissertation.
- Ackema, Peter & Maaïke Schoorlemmer. 1995. Middles and nonmovement. *Linguistic Inquiry* 26. 173–197.
- Ackema, Peter & Maaïke Schoorlemmer. 2006. Middles. In Martin Everaert & Henk van Riemsdijk (eds.), *The Blackwell Companion to Syntax*, vol. III, 131–203. Blackwell.
- Acquaviva, Paolo. 2008. *Lexical plurals: a morpho-semantic approach*. Oxford: Oxford University Press.
- Adger, David. 2013. *A Syntax of Substance*. Cambridge, MA: MIT Press.
- Alexiadou, Artemis. 2001. *Functional structure in nominals*. Philadelphia/Amsterdam: John Benjamins.
- Alexiadou, Artemis. 2003. Some notes on the structure of alienable and inalienable possessors. In Martine Coene & Yves D’huylst (eds.), *From NP to DP Volume II: The Expression of Possession in Noun Phrases*, 167–188. Philadelphia/Amsterdam: John Benjamins.
- Alexiadou, Artemis. 2009. On the role of syntactic locality in morphological processes: The case of (Greek) derived nominals. In Anastasia Giannakidou & Monika Rathert (eds.), *Quantification, Definiteness and Nominalization*, 253–280. Oxford University Press.
- Alexiadou, Artemis. 2011. Plural Mass Nouns and the Morpho-syntax of Number. In Mary Byram Washburn (ed.), *Proceedings of the 28th West Coast Conference on Formal Linguistics*, 33–41. Somerville, MA: Cascadilla Proceedings Project.
- Alexiadou, Artemis. 2017a. Ergativity in nominalization. In Jessica Coon, Diane Massam & Lisa Travis (eds.), *Oxford handbook on ergativity*, 355–372. Oxford University Press.
- Alexiadou, Artemis. 2017b. On the complex relationship between deverbal compounds and argument supporting nominals. In A. Malicka-Kleparska & M. Bloch-Trojna (eds.), *Aspect and valency in nominals*, 53–82. Mouton de Gruyter.
- Alexiadou, Artemis. 2019. On plurals and plurality. *Selected Papers of IStAL 23* 3–18.
- Alexiadou, Artemis, Elena Anagnostopoulou & Florian Schäfer. 2009. PP licensing in nominalizations. In Anisa Schardl, Martin Walkow & Muhammad Abdurrahman (eds.), *Proceedings of the 38th Annual Meeting of the North East Linguistic Society*, vol. I, 39–51. Amherst, MA: GLSA Publications.
- Alexiadou, Artemis, Elena Anagnostopoulou & Florian Schäfer. 2015. *External Arguments in Transitivity Alternations: A Layering Approach*. Oxford: Oxford University Press.
- Alexiadou, Artemis, Elena Anagnostopoulou & Christina Sevdali. 2014a. Opaque and transparent datives, and how they behave in passives. *Journal of Comparative Germanic Linguistics* 17(1). 1–34.
- Alexiadou, Artemis, Berit Gehrke & Florian Schäfer. 2014b. The structure of adjectival participles revisited. *Lingua* 149. 118–138.
- Alexiadou, Artemis & Jane Grimshaw. 2008. Verbs, nouns and affixation. In Florian Schäfer (ed.), *SinSpeC (1): Working Papers of the SFB 732*, 1–16. Stuttgart: University of Stuttgart.
- Alexiadou, Artemis, Gianina Iordăchioaia, Mariángeles Cano, Fabienne Martin & Florian Schäfer. 2013. The realization of external arguments in nominalizations. *Journal of Comparative Germanic Linguistics* 16(2-3). 73–95.
- Alexiadou, Artemis, Gianina Iordăchioaia & Elena Soare. 2010a. Number/aspect interactions in the syntax of nominalizations: A Distributed Morphology approach. *Journal of Linguistics* 46(3). 537–574.

- Alexiadou, Artemis, Gianina Iordăchioaia & Elena Soare. 2010b. Plural marking in argument supporting nominalizations. In Patricia Cabredo Hofherr & Brenda Laca (eds.), *Layers of aspect*, 1–22. Stanford, CA: CSLI Publications.
- Alexiadou, Artemis, Gianina Iordăchioaia & Elena Soare. 2010c. Syntactic realizations of plural in Romance and Germanic nominalizations. In Karlos Arregi, Zsuzsanna Fagyal, Silvina Montrul & Annie Tremblay (eds.), *Romance Linguistics 2008: Interactions in Romance*, 107–124. Amsterdam/Philadelphia: John Benjamins.
- Alexiadou, Artemis & Florian Schäfer. 2010. On the syntax of episodic vs. dispositional *-er* nominals. In Artemis Alexiadou & Monika Rathert (eds.), *The syntax of nominalizations across languages and frameworks*, 9–38. Berlin: Mouton de Gruyter.
- Anagnostopoulou, Elena. 2012. Compositionality, allosemy and idiomaticity in participles. Manuscript, University of Crete.
- Anagnostopoulou, Elena & Panagiota Samioti. 2009. Domains for idioms. Roots Workshop, University of Stuttgart.
- Anagnostopoulou, Elena & Panagiota Samioti. 2013. Allosemy, idioms and their domains: Evidence from adjectival participles. In Raffaella Folli, Christina Sevdali & Robert Truswell (eds.), *On syntax and its limits*, 218–250. Oxford: Oxford University Press.
- Anagnostopoulou, Elena & Panagiota Samioti. 2014. Domains within words and their meanings: A case study. In Artemis Alexiadou, Hagit Borer & Florian Schäfer (eds.), *The syntax of Roots and the roots of Syntax*, 81–111. Oxford: Oxford University Press.
- Anderson, Stephen R. 1969a. An outline of the phonology of Modern Icelandic vowels. *Foundations of Language* 5. 53–72.
- Anderson, Stephen R. 1969b. *West Scandinavian Vowel Systems and the Ordering of Phonological Rules*: MIT Doctoral Dissertation.
- Andreou, Marios & Rochelle Lieber. 2020. Aspectual and quantificational properties of deverbal conversion and *-ing* nominalizations: The power of context. *English Language & Linguistics* 24(2). 333–363.
- Arad, Maya. 2003. Locality constraints on the interpretation of roots: The case of Hebrew denominal verbs. *Natural Language & Linguistic Theory* 21. 737–778.
- Arad, Maya. 2005. *Roots and Patterns: Hebrew Morpho-syntax*. Dordrecht: Springer.
- Árnason, Kristján. 1992. Problems in the Lexical Phonology of Icelandic. In *Phonologica 1988: Proceedings of the 6th International Phonology Meeting, [July 1-4, 1988, in Krems, Austria]*, Cambridge: Cambridge University Press.
- Árnason, Kristján. 2005. *Hljóð: Handbók um hljóðfræði og hljóðkerfisfræði [Sounds: A Handbook of Phonetics and Phonology]*. Íslensk tunga I [The Icelandic Language I]. Reykjavík: Almenna bókfélagið.
- Árnason, Kristján. 2011. *The Phonology of Icelandic and Faroese*. Oxford: Oxford University Press.
- Arregi, Karlos & Andrew Nevins. 2012. *Morphotactics: Basque auxiliaries and the structure of spellout*. Springer.
- Asher, Nicholas. 2011. *Lexical meaning in context: A web of words*. Cambridge: Cambridge University Press.
- Baker, Mark. 2015. *Case: Its Principles and its Parameters*. Cambridge: Cambridge University Press.
- Baker, Mark C & Bleu Gildas Gondo. 2020. Possession and nominalization in Dan: Evidence for a general theory of categories. *Glossa: A journal of general linguistics* 5(1).
- Baker, Mark C & Nadya Vinokurova. 2009. On agent nominalizations and why they are not like event nominalizations. *Language* 85(3). 517–556.
- Barðdal, Jóhanna. 2001a. *Case in Icelandic: A Synchronic, Diachronic, and Comparative Approach*: Lund University Doctoral Dissertation.
- Barðdal, Jóhanna. 2001b. The perplexity of dat-nom verbs in Icelandic. *Nordic Journal of Linguistics* 24(1). 47–70.
- Barkarson, Starkaður, Steinþór Steingrímsson & Hildur Hafsteinsdóttir. 2022. Evolving large text corpora: Four versions of the Icelandic Gigaword corpus. In *Proceedings of the Thirteenth Language Resources and Evaluation Conference*, 2371–2381. Marseille: European Language Resources Association. <https://aclanthology.org/2022.lrec-1.254>.
- Barker, Chris. 1998. Episodic *-ee* in English: A thematic role constraint on new word formation. *Language* 695–727.
- Barker, Christopher. 1995. *Possessive Descriptions*. Stanford University: CSLI Publications.
- Beavers, John & Andrew Koontz-Garboden. 2012. Manner and Result in the Roots of Verbal Meaning. *Linguistic Inquiry* 43(3). 331–369. doi:10.1162/LING\_a\_00093.
- Béjar, Susana & Diane Massam. 1999. Multiple case checking. *Syntax* 2(2). 65–79.
- Bhatt, Rajesh & Roumyana Pancheva. 2006. Implicit Arguments. In Martin Everaert & Henk van Riemsdijk (eds.), *The Blackwell Companion to Syntax*, vol. II, 558–588. Malden, MA: Blackwell.
- Bianchi, Valentina. 2000. The Raising Analysis of Relative Clauses: A Reply to Borsley. *Linguistic Inquiry* 31(1). 123–140.

- Biggs, Alison & David Embick. 2022. On the Event-Structural Properties of the English Get-Passive. *Linguistic Inquiry* 53(2). 211–254.
- Biskup, Petr. 2007. P(refixe)s and P(reposition)s. In B. Dvořák (ed.), *Proceedings of the 2nd Congress of SLS*, .
- Biskup, Petr & Michael Putnam. 2012. One P with two Spell-Outs: the *ent-/aus-* alternation in German. *Linguistic Analysis* 38(1-2). 69–109.
- Bjarnadóttir, Kristín. 2005. *Afleiðsla og samsetning í generatífri málfraði og greining á íslenskum gögnum*. Reykjavík: Orðabók Háskólans. Available at <http://www.lexis.hi.is/kristinb/afleidslaogsams.pdf>.
- Bobaljik, Jonathan David. 2012. *Universals in Comparative Morphology: Suppletion, Superlatives, and the Structure of Words*. Cambridge, MA: MIT Press.
- Bobaljik, Jonathan David & Susi Wurmbrand. 2013. Suspension across domains. In Ora Matushansky & Alec Marantz (eds.), *Distributed Morphology Today: Morphemes for Morris Halle*, 185–198. MIT Press.
- Borer, Hagit. 1997. The morphology-syntax interface: A study of autonomy. In Wolfgang U Dressler, Martin Prinzhorn & John R. Rennison (eds.), *Advances in morphology*, 5–30. The Hague: de Gruyter.
- Borer, Hagit. 2003. Exo-skeletal vs. endo-skeletal explanations: syntactic projections and the lexicon. In John Moore & Maria Polinsky (eds.), *The Nature of Explanation in Linguistic Theory*, 31–68. Stanford, CA: CSLI.
- Borer, Hagit. 2005. *Structuring Sense Volume 1: In Name Only*. Oxford: Oxford University Press.
- Borer, Hagit. 2012. In the event of a nominal. In Martin Everaert, Marijana Marelj & Tal Siloni (eds.), *The Theta System: Argument Structure at the Interface*, 103–149. Oxford: Oxford University Press.
- Borer, Hagit. 2013. *Structuring Sense Volume 3: Taking Form*. Oxford: Oxford University Press.
- Borer, Hagit. 2014. Derived nominals and the domain of content. *Lingua* 141. 71–96.
- Bošković, Željko. 2014. Now I'm a phase, now I'm not a phase: On the variability of phases with extraction and ellipsis. *Linguistic Inquiry* 45. 27–89.
- Bruening, Benjamin. 2010a. Ditransitive asymmetries and a theory of idiom formation. *Linguistic Inquiry* 41(4). 519–562.
- Bruening, Benjamin. 2010b. Double object constructions disguised as prepositional datives. *Linguistic Inquiry* 41(2). 287–305.
- Bruening, Benjamin. 2013. By phrases in passives and nominals. *Syntax* 16(1). 1–41.
- Bruening, Benjamin. 2018a. Double Object Constructions and Prepositional Dative Constructions Are Distinct: A Reply to Ormazabal and Romero 2012. *Linguistic Inquiry* 49(1). 123–150.
- Bruening, Benjamin. 2018b. Word formation is syntactic: Raising in nominalizations. *Glossa: a journal of general linguistics* 3(1). 102. doi:<http://doi.org/10.5334/gjgl.470>.
- Bruening, Benjamin. 2021. Implicit arguments in English double object constructions. *Natural Language & Linguistic Theory* 39(4). 1023–1085. doi:<https://doi.org/10.1007/s11049-020-09498-4>.
- Calabrese, Andrea. 2011. Investigations on markedness, syncretism and zero exponence in morphology. *Morphology* 21(2). 283–325.
- Choi, Jaehoon & Heidi Harley. 2019. Locality domains and morphological rules. *Natural Language & Linguistic Theory* 37(4). 1319–1365.
- Chomsky, Noam. 1970. Remarks on nominalization. In Roderick Jacobs & Peter Rosenbaum (eds.), *Readings in English Transformational Grammar*, 184–221. Waltham, MA: Ginn and Company.
- Chomsky, Noam. 1995. *The Minimalist Program*. Malden, MA: MIT Press.
- Chomsky, Noam. 2020. Remarks on nominalization: Background and motivation. In Artemis Alexiadou & Hagit Borer (eds.), *Nominalizations: 50 Years on from Chomsky's Remarks*, 25–28. Oxford: Oxford University Press.
- Cinque, Guglielmo. 2010. *The syntax of adjectives: A comparative study*. MIT Press.
- Collins, Chris & Höskuldur Thráinsson. 1996. VP-internal structure and Object Shift in Icelandic. *Linguistic Inquiry* 27(3). 391–444.
- Comrie, Bernard. 1976. The syntax of action nominals: A cross-language study. *Lingua* 40(2-3). 177–201.
- Creemers, Ava, Jan Don & Paula Fenger. 2018. Some affixes are roots, others are heads. *Natural Language & Linguistic Theory* 36(1). 45–84.
- De Belder, Marijke. 2017. The Root and Nothing but the Root: Primary Compounds in Dutch. *Syntax* 20(2). 138–169.
- De Belder, Marijke & Marjo van Koppen. 2016. One module, different levels of merge: AN(N) compounds in Dutch. *Studia Linguistica* 70(1). 1–33.
- Delsing, Lars-Olof. 1993. *The Internal Structure of Noun Phrases in the Scandinavian Languages*: University of Lund Doctoral Dissertation.

- Delsing, Lars-Olof. 1998. Possession in Germanic. In Artemis Alexiadou & Chrisa Wilder (eds.), *Possessors, Predicates, and Movement in the Determiner Phrase*, 87–108. Amsterdam/Philadelphia: John Benjamins.
- Den Dikken, Marcel. 1995. *Particles: On the Syntax of Verb-Particle, Triadic, and Causative Constructions*. Oxford: Oxford University Press.
- Den Dikken, Marcel. 2006. *Relators and linkers: the syntax of predication, predicate inversion, and copulas*. Cambridge, MA: MIT Press.
- Den Dikken, Marcel. 2007a. Phase Extension: A reply. *Theoretical Linguistics* 33(1). 133–163.
- Den Dikken, Marcel. 2007b. Phase Extension: Contours of a theory of the role of head movement in phrasal extraction. *Theoretical Linguistics* 33(1). 1–41.
- Den Dikken, Marcel. 2010. Directions from the GET-GO. On the syntax of manner-of-motion verbs in directional constructions. *Catalan Journal of Linguistics* 9. 23–53.
- Di Scullio, Anna Maria & Edwin Williams. 1987. *On the definition of word*. Cambridge, MA: MIT Press.
- Eik, Ragnhild. 2019. *The Morphosyntax of Compounding in Norwegian*: Norwegian University of Science and Technology Doctoral Dissertation.
- Embick, David. 1997. *Voice and the Interfaces of Syntax*: University of Pennsylvania Doctoral Dissertation.
- Embick, David. 2003. Locality, listedness, and morphological identity. *Studia Linguistica* 57(3). 143–169.
- Embick, David. 2004. On the structure of resultative participles in English. *Linguistic Inquiry* 35(3). 355–392.
- Embick, David. 2010. *Localism versus Globalism in Morphology and Phonology*. Cambridge, MA: MIT Press.
- Embick, David. 2016. Approaching *Polymorphy*. Sociedad Argentina de Análisis Filosófico (SADAF).
- Embick, David & Alec Marantz. 2008. Architecture and blocking. *Linguistic Inquiry* 39(1). 1–53.
- Engelhardt, Miriam. 2000. The projection of argument-taking nominals. *Natural Language & Linguistic Theory* 18(1). 41–88.
- Fábregas, Antonio. 2014. Argument structure and morphologically underived nouns in Spanish and English. *Lingua* 141. 97–120.
- Folli, Raffaella & Heidi Harley. 2006. On the licensing of causatives of directed motion: Waltzing Matilda all over. *Studia Linguistica* 60(2). 121–155.
- Folli, Raffaella & Heidi Harley. 2013. The syntax of argument structure: Evidence from Italian complex predicates. *Journal of Linguistics* 49(1). 93–125.
- Fox, Danny & David Pesetsky. 2005. Cyclic Linearization of Syntactic Structure. *Theoretical Linguistics* 31(1/2). 1–45.
- Fu, Jingqi, Thomas Roeper & Hagit Borer. 2001. The VP within Process Nominals: Evidence from Adverbs and the VP Anaphor Do-So. *Natural Language & Linguistic Theory* 19(3). 549–582. doi:10.1023/A:1010654105760.
- Gallego, Ángel J. 2010. *Phase Theory*. Philadelphia/Amsterdam: John Benjamins.
- Gast, Volker, Kristín M. Jóhannsdóttir & Michael Putnam. 2016. Extending event structure: Over-modification in Icelandic. Paper presented at GLAC 22, University of Iceland.
- Gibson, Courtenay St. John & Catherine O. Ringen. 2000. Icelandic umlaut in Optimality Theory. *Nordic Journal of Linguistics* 23. 49–64.
- Green, Georgia. 1974. *Semantics and syntactic regularity*. Bloomington: Indiana University Press.
- Grimm, Scott & Louise McNally. 2013. No ordered arguments needed for nouns. In Maria Aloni, Michael Franke & Floris Roelofsen (eds.), *Proceedings of the 19th Amsterdam Colloquium*, 123–130. Amsterdam: ILLC.
- Grimshaw, Jane. 1990. *Argument Structure*. Cambridge, MA: MIT Press.
- Haider, Hubert. 2001. How to stay accusative in insular Germanic. *Working Papers in Scandinavian Syntax* 68. 1–14.
- Hale, Kenneth & Samuel Jay Keyser. 1993. On argument structure and the lexical expression of syntactic relations. In Kenneth Hale & Samuel Jay Keyser (eds.), *The View from Building 20: Essays in Honor of Sylvain Bromberger*, 53–109. Cambridge, MA: MIT Press.
- Hale, Kenneth & Samuel Jay Keyser. 2002. *Prolegomenon to a Theory of Argument Structure* Linguistic Inquiry Monographs. Cambridge, MA: MIT Press.
- Harðarson, Gísli Rúnar. 2016. Peeling away the layers of the onion: On layers, inflection and domains in Icelandic compounds. *Journal of Comparative Germanic Linguistics* 19(1). 1–47.
- Harðarson, Gísli Rúnar. 2017. *Cycling through grammar: On compounds, noun phrases and domains*: University of Connecticut Doctoral Dissertation.
- Harðarson, Gísli Rúnar. 2018. Forming a compound and spelling it out. *University of Pennsylvania Working Papers in Linguistics* 24(1). 11.

- Harðarson, Gísli Rúnar. To appear. Only the tall and the small: Size restrictions on Icelandic possessors. In Sabine Lazsakovits & Zheng Shen (eds.), *The size of things II: Movement, features and interpretation*, Berlin: Language Science Press.
- Harley, Heidi. 2002. Possession and the double object construction. *Linguistic Variation Yearbook* 2. 31–70.
- Harley, Heidi. 2009a. Compounding in Distributed Morphology. In Rochelle Lieber & Pavol Stekaur (eds.), *The Oxford Handbook of Compounding*, 129–144. Oxford: Oxford University Press.
- Harley, Heidi. 2009b. The morphology of nominalizations and the syntax of vP. In Anastasia Giannakidou & Monika Rathert (eds.), *Quantification, Definiteness, and Nominalization*, 321–343. Oxford: Oxford University Press.
- Harley, Heidi. 2010. The Canonical Use Constraint, Nouns, Roots and Idiomatic Domains. Manuscript, University of Arizona.
- Harley, Heidi & Hyun Kyoung Jung. 2015. In Support of the P<sub>have</sub> Analysis of the Double Object Construction. *Linguistic Inquiry* 46(4). 703–730. doi:10.1162/LING\_a\_00198.
- Harley, Heidi & Rolf Noyer. 1997. Mixed nominalizations, short verb movement and object shift in English. In Pius N. Tamanji & Kiyomi Kusumoto (eds.), *Proceedings of NELS 28*, 143–157. Amherst: University of Massachusetts, GLSA.
- Harley, Heidi & Rolf Noyer. 2000. Formal versus encyclopedic properties of vocabulary: Evidence from nominalizations. In B. Peeters (ed.), *The lexicon-encyclopedia interface*, 349–374. Oxford: Elsevier.
- Harley, Heidi & Megan Stone. 2013. The ‘No Agent Idioms’ Hypothesis. In Raffaella Folli, Christina Sevdali & Robert Truswell (eds.), *Syntax and its limits*, 283–311. Oxford: Oxford University Press.
- Heim, Irene & Angelika Kratzer. 1998. *Semantics in Generative Grammar*. Wiley-Blackwell.
- Helgadóttir, Sigrún, Ásta Svavarsdóttir, Eiríkur Rögnvaldsson, Kristín Bjarnadóttir & Hrafn Loftsson. 2012. The Tagged Icelandic Corpus (MÍM). In *Proceedings of the Workshop on Language Technology for Normalisation of Less-Resourced Languages*, 67–72.
- Hidalgo, Matías Jaque & Josefa Martín García. 2012. Configurational constraints on non-eventive nominalizations in Spanish. *Nordlyd* 39(1). 113–140.
- Hilmisdóttir, Helga. 2007. *A sequential analysis of nú and nuna in Icelandic conversation*. Department of Scandinavian Languages and Literature, University of Helsinki.
- Holmberg, Anders. 1999. Remarks on Holmberg’s Generalization. *Studia Linguistica* 53(1). 1–39.
- Hu, Xuhui & J Joseph Perry. 2018. The syntax and phonology of non-compositional compounds in Yixing Chinese. *Natural Language & Linguistic Theory* 36(3). 701–742.
- Indriðason, Þorsteinn G. 1999. Um eignarfallssamsetningar og aðrar samsetningar í íslensku. *Íslenskt mál og almenn málfræði* 21. 107–150.
- Indriðason, Þorsteinn G. 2006. Í líki hvers? [The many faces of líki in Icelandic]. *Íslenskt mál og almenn málfræði* 28. 95–111.
- Indriðason, Þorsteinn G. 2014. Fallbeygðir fyrri liðir og tvær kenningar um orðhlutafræði. *Íslenskt mál og almenn málfræði* 36. 9–30.
- Ingason, Anton Karl. 2013. Icelandic Umlaut as Morpheme Specific Phonology. Paper presented at *Phonology 2013*, University of Massachusetts, Amherst, November 10.
- Ingason, Anton Karl. 2016. *Realizing Morphemes in the Icelandic Noun Phrase*: University of Pennsylvania Doctoral Dissertation.
- Ingason, Anton Karl & Einar Freyr Sigurðsson. 2015. Phase locality in Distributed Morphology and two types of Icelandic agent nominals. In Thuy Bui & Deniz Özyıldız (eds.), *Proceedings of the 45th Meeting of the North East Linguistic Society*, vol. II, 45–58. Amherst, MA: GLSA Publications.
- Ingason, Anton Karl & Einar Freyr Sigurðsson. 2020. Attributive compounds. In *Oxford Research Encyclopedia of Linguistics*, Oxford University Press. doi:{https://doi.org/10.1093/acrefore/9780199384655.013.563}.
- Iordăchioaia, Gianina. 2008. External argument PPs in Romanian nominalizations. *Working Papers of the SFB 732(1)*. 71–84.
- Iordăchioaia, Gianina. 2019a. English deverbal compounds with and without arguments. In Eszter Ronai, Laura Stigliano & Yen-an Sun (eds.), *Proceedings of the Fifty-fourth Annual Meeting of the Chicago Linguistic Society*, 179–193. Chicago, IL: Chicago Linguistic Society.
- Iordăchioaia, Gianina. 2019b. Event and argument structure in English zero-derived nominals. Paper presented at *Societas Linguistica Europaea* 52, Universität Leipzig, August 21–24.
- Iordăchioaia, Gianina. 2019c. The root derivation of psych nominals: Implications for competing overt and zero nominalizers. *Bucharest Working Papers in Linguistics XXI(2)*. 57–79.

- Iordăchioaia, Gianina. 2020a. Categorization and nominalization in zero nominals. In Artemis Alexiadou & Hagit Borer (eds.), *Nominalizations: 50 Years on from Chomsky's Remarks*, 231–253. Oxford: Oxford University Press.
- Iordăchioaia, Gianina. 2020b. Event structure and argument realization in English zero-derived nominals with particles. *Nordlyd* 44(1). 35–51.
- Iordăchioaia, Gianina & Elena Soare. 2008. Two Kinds of Event Plurals: Evidence from Romanian Nominalizations. In Olivier Bonami & Patricia Cabredo Hofherr (eds.), *Empirical Issues in Syntax and Semantics 7*, 193–216. CSSP.
- Iordăchioaia, Gianina & Martina Werner. 2019. Categorical shift via aspect and gender change in deverbal nouns. *Language Sciences* 73. 62–76.
- Iordăchioaia, Gianina, Artemis Alexiadou & Andreas Pairamidis. 2017. Morphosyntactic sources for nominal synthetic compounds in English and Greek. *Journal of Word Formation* 1. 47–71.
- Irwin, Patricia. 2012. *Unaccusativity at the Interfaces*: New York University Doctoral Dissertation.
- Jackson, Scott & Jeffrey Punske. 2013. Deriving English compound stress: insights from Distributed Morphology and multiple spellout. *Linguistic Analysis* 38. 243–274.
- Jóhannsdóttir, Kristín M. 1995. The argument structure of deverbal nominals in Icelandic. *University of Tromsø Working Papers in Linguistics* 25. 61–88.
- Jóhannsdóttir, Kristín M. 2005. Temporal adverbs in Icelandic: Adverbs of quantification vs. frequency adverbs. *Working Papers in Scandinavian Syntax* 76. 31–72.
- Jóhannsdóttir, Kristín M. 2007. Temporal adverbs in Icelandic: adverbs of quantification vs. frequency adverbs. *Nordic Journal of Linguistics* 30(2). 157–183.
- Jóhannsdóttir, Kristín M. 2011. *Aspects of the Progressive in English and Icelandic*: University of British Columbia, Vancouver Doctoral Dissertation.
- Jónasson, Guðjón Ragnar. 2008. *Ólafsfirska*: University of Iceland M.A. Thesis.
- Jónsdóttir, Margrét. 2005. Um *væða* og *væðingu* og hlutverk þeirra í samsetningum. *Orð og tunga* 7. 95–120.
- Jónsson, Jóhannes Gísli. 1996. *Clausal Architecture and Case in Icelandic*: University of Massachusetts, Amherst Doctoral Dissertation.
- Jónsson, Jóhannes Gísli. 2003. Not so quirky: On subject case in Icelandic. In Ellen Brandner & Heike Zinsmeister (eds.), *New Perspectives on Case Theory*, 127–163. Stanford, CA: CSLI.
- Jónsson, Jóhannes Gísli. 2005. Merkingarhlutverk, rökliðir og fallmörkun [Thematic roles, arguments and case-marking]. In Höskuldur Thráinsson (ed.), *Setningar [Sentences] Íslensk tunga III [The Icelandic Language III]*, 265–349. Reykjavík: Almenna bókafélagið.
- Jónsson, Jóhannes Gísli. 2009. Covert nominative and dative subjects in Faroese. *Nordlyd* 36(2). 142–164.
- Jónsson, Jóhannes Gísli. 2010. Dative/Accusative variation and event structure in Icelandic. Paper presented at 4th European Dialect Syntax Meeting, 'Variation in datives: a micro-comparative perspective', Donostia/San Sebastián, June 21–23.
- Jónsson, Jóhannes Gísli. 2013a. Dative versus accusative and the nature of inherent case. In Beatriz Fernández & Ricardo Etxepare (eds.), *Variation in Datives: A Micro-Comparative Perspective*, 144–160. Oxford: Oxford University Press.
- Jónsson, Jóhannes Gísli. 2013b. Two types of case variation. *Nordic Journal of Linguistics* 36(1). 5–25.
- Josefsson, Gunlög. 1998. *Minimal words in a minimal syntax*. John Benjamins.
- Josefsson, Gunlög. 2005. How could Merge be free and word formation restricted: The case of compounding in Romance and Germanic. *Working Papers in Scandinavian Syntax* 75. 55–96.
- Julien, Marit. 2005. *Nominal Phrases from a Scandinavian Perspective*. Philadelphia: John Benjamins.
- Kallulli, Dalina. 2007. Rethinking the passive/anticausative distinction. *Linguistic Inquiry* 38(4). 770–780.
- Kastner, Itamar. 2016. *Form and Meaning in the Hebrew Verb*: New York University Doctoral Dissertation.
- Kastner, Itamar. 2017. Reflexive verbs in Hebrew: Deep unaccusativity meets lexical semantics. *Glossa: a journal of general linguistics* 2(1). 75.
- Kastner, Itamar. 2019a. Inchoatives in causative clothing: Change of state in Modern Hebrew *heXYiZ*. *The Linguistic Review* 36(3). 437–451. <https://doi.org/10.1515/tlr-2019-2025>.
- Kastner, Itamar. 2019b. Templatic morphology as an emergent property: Roots and functional heads in Hebrew. *Natural Language & Linguistic Theory* 37(2). 571–619. <https://doi.org/10.1007/s11049-018-9419-y>.
- Kastner, Itamar & Patricia Irwin. 2018. A type-theoretic syntax for lexical semantics. Talk given at HU–HUJI Workshop, July 18.
- Kayne, Richard S. 1981. Unambiguous paths. In Robert May & Jan Koster (eds.), *Levels of Syntactic Representation*, 143–183. Dordrecht: Foris.

- Kayne, Richard S. 1984. *Connectedness and Binary Branching*. Dordrecht: Foris.
- Kayne, Richard S. 1994. *The Antisymmetry of Syntax*. Malden, MA: MIT Press.
- Kayne, Richard S. 1997. The English complementizer *of*. *Journal of Comparative Germanic Linguistics* 1(1). 43–54.
- Kayne, Richard S. 2004. Prepositions as Probes. In Adriana Belletti (ed.), *Structures and beyond: The cartography of syntactic structures, volume 3*, 133–166. New York: Oxford University Press.
- Kayne, Richard S. 2005a. *For* and ECM. Paper presented at the Workshop on the Internal Structure of PPs, University of Venice, November 2005.
- Kayne, Richard S. 2005b. Some Notes on Comparative Syntax With Special Reference to English and French. In Richard S. Kayne (ed.), *Movement and Silence*, 277–333. Oxford: Oxford University Press.
- Kayne, Richard S. 2006. On Parameters and on Principles of Pronunciation. In H. Broekhuis, N. Corver, R. Huybregts, U. Kleinhenz & J. Koster (eds.), *Organizing Grammar: Linguistic Studies in Honor of Henk van Riemsdijk*, 289–299. Berlin: Mouton de Gruyter.
- Kayne, Richard S. 2008. Antisymmetry and the lexicon. *Linguistic Variation Yearbook* 8(1). 1–30.
- Kiparsky, Paul. 1985. Some consequences of lexical phonology. *Phonology Yearbook* 2. 85–138.
- Knittel, Marie Laurence. 2010. Possession vs. pseudo-incorporation in the nominal domain: Evidence from French event nominals dependencies. *The Linguistic Review* 27. 177–230.
- Koontz-Garboden, Andrew. 2007. *States, changes of state, and the Monotonicity Hypothesis*: Stanford University Doctoral Dissertation.
- Kramer, Ruth. 2014. Gender in Amharic: A morphosyntactic approach to natural and grammatical gender. *Language Sciences* 43. 102–115.
- Kramer, Ruth. 2015. *The morphosyntax of gender*. Oxford University Press.
- Kramer, Ruth. 2016. The location of gender features in the syntax. *Language and Linguistics Compass* 10. 661–677.
- Kratzer, Angelika. 2003. The Event Argument. Manuscript, University of Massachusetts, Amherst.
- Kristinsson, Ari Páll. 2004. *Orðmyndun: Um leiðir til að auka íslenskan orðaforða*. Reykjavík: Íslensk málnefnd.
- Kupula, Mikko. 2011. A phase extension approach to double object constructions: Evidence from Modern Greek. *Studia Linguistica* 65(2). 147–169.
- Kučerova, Ivona. 2018.  $\phi$ -features at the syntax–semantics interface: Evidence from nominal inflection. *Linguistic Inquiry* 49. 813–845.
- Kvaran, Guðrún. 2005. *Orð Íslensk tunga II*. Reykjavík: Almenna bókfélagið.
- Landau, Idan. 2010. The explicit syntax of implicit arguments. *Linguistic Inquiry* 41(3). 357–388.
- Larson, Richard K & Vida Samiian. 2021. *Ezafe*, PP and the nature of nominalization. *Natural Language & Linguistic Theory* 39(1). 157–213.
- Lees, Robert. 1960. *The grammar of English nominalizations*. The Hague: Mouton.
- Legate, Julie Anne. 2014. *Voice and v: Lessons from Acehnese*. Cambridge, MA: MIT Press.
- Lekakou, Maria. 2005. *In the Middle, Somewhat Elevated: The semantics of middles and its crosslinguistic realization*: University College London Doctoral Dissertation.
- Levin, Beth & Malka Rappaport. 1986. The formation of adjectival passives. *Linguistic Inquiry* 17(4). 623–661.
- Levin, Beth & Malka Rappaport Hovav. 1991. Wiping the slate clean: A lexical semantic exploration. *Cognition* 41(1-3). 123–151.
- Levin, Beth & Malka Rappaport Hovav. 2013. Lexicalized Meaning and Manner/Result Complementarity. In Boban Arsenijević, Berit Gehrke & Rafael Marín (eds.), *Studies in the Composition and Decomposition of Event Predicates*, 49–70. Dordrecht: Springer. [https://doi.org/10.1007/978-94-007-5983-1\\_3](https://doi.org/10.1007/978-94-007-5983-1_3).
- Levin, Beth & Malka Rappaport Hovav. 2014. Manner and Result: A View from *clean*. In R. Pensalfini, M. Turpin & D. Guillemin (eds.), *Language Description Informed by Theory*, 337–357. Philadelphia/Amsterdam: John Benjamins.
- Levinson, Lisa. 2007. *The roots of verbs*: New York University Doctoral Dissertation.
- Levinson, Lisa. 2010. Arguments for pseudo-resultative predicates. *Natural Language & Linguistic Theory* 28(1). 135–182.
- Levinson, Lisa. 2011. Possessive WITH in Germanic: HAVE and the role of P. *Syntax* 14(4). 355–393.
- Levinson, Lisa. 2014. The ontology of roots and verbs. In Artemis Alexiadou, Hagit Borer & Florian Schäfer (eds.), *The syntax of roots and the roots of syntax*, 208–229. Oxford: Oxford University Press.
- Lieber, Rochelle. 2017. *English nouns: The ecology of nominalization*. Cambridge: Cambridge University Press.

- Lowenstamm, Jean. 2015. Derivational affixes as roots: Phasal spell-out meets English stress shift. In Artemis Alexiadou, Hagit Borer & Florian Schäfer (eds.), *The syntax of roots and the roots of syntax*, 230–259. Oxford: Oxford University Press.
- Lyons, Christopher. 1986. The syntax of English genitive constructions. *Journal of Linguistics* 22. 123–143.
- Magnússon, Friðrik. 1984. Um innri gerð nafnliða í íslensku [On the internal structure of noun phrases in Icelandic]. *Íslenskt mál og almenn málfræði* 6. 81–111.
- Maling, Joan. 2001. Dative: The heterogeneity of the mapping among morphological case, grammatical functions, and thematic roles. *Lingua* 111(4-7). 419–464.
- Maling, Joan. 2002a. Það rignir þágufalli á Íslandi: Sagnir sem stjórna þágufalli á andlagi sínu [It's raining dative in Iceland: Verbs with dative objects in Icelandic]. *Íslenskt mál og almenn málfræði* 24. 31–106.
- Maling, Joan. 2002b. Icelandic verbs with dative objects. *Working Papers in Scandinavian Syntax* 70. 1–60.
- Marantz, Alec. 1991/2000. Case and Licensing. In Eric Reuland (ed.), *Arguments and Case: Explaining Burzio's Generalization*, 11–30. Philadelphia: John Benjamins.
- Marantz, Alec. 1997. No escape from syntax: Don't try morphological analysis in the privacy of your own lexicon. *University of Pennsylvania Working Papers in Linguistics* 4(2). 201–225.
- Marantz, Alec. 2009a. Resultatives and re-resultatives: Direct objects may construct events by themselves. Paper presented at Penn Linguistics Colloquium.
- Marantz, Alec. 2009b. Roots, re-, and affected agents: can roots pull the agent under little v? Talk given at Roots workshop - Universität Stuttgart - June 10-13, 2009.
- Marantz, Alec. 2013a. Locality domains for contextual allomorphy across the interfaces. In Ora Matushansky & Alec Marantz (eds.), *Distributed Morphology Today: Morphemes for Morris Halle*, 95–115. MIT Press.
- Marantz, Alec. 2013b. Locating the Verbal Root. Talk given at the 25th Scandinavian Conference of Linguistics, Reykjavík, Iceland, May 13th.
- Marantz, Alec. 2013c. Verbal argument structure: Events and participants. *Lingua* 130. 152–168.
- Marantz, Alec. 2018. Unergatives and the Autonomy of Syntax. Talk given at the workshop: Unergative predicates: Architecture and variation, January 18-19.
- Marantz, Alec. 2022. Rethinking the syntactic role of word formation: A lesson from Complex Event Nominalizations. In Nora Boneh, Daniel Harbour, Ora Matushansky & Isabelle Roy (eds.), *Building on Babel's Rubble*, 293–316. Presses Universitaires de Vincennes. <https://www.univ-paris8.fr/Building-on-Babel-s-rubble>.
- Markova, Angelina. 2010. The syntax of deverbal nominals in Bulgarian. In Artemis Alexiadou & Monika Rathert (eds.), *The syntax of nominalizations across languages and frameworks*, 93–128. Berlin: Mouton de Gruyter.
- Markússon, Jón Símon. 2012. *Eðli u-hljóðvarpsvíxla í íslenskri málsögu [The Nature of the U-Umlaut in the History of Icelandic]*: University of Iceland M.A. Thesis.
- McFadden, Thomas. 2004. *The Position of Morphological Case in the Derivation: A Study on the Syntax-Morphology Interface*: University of Pennsylvania Doctoral Dissertation.
- McGinnis, Martha. 2020. Cross-linguistic contrasts in the structure of causatives in clausal nominalizations. In Bronwyn Moore Bjorkman & Daniel Currie Hall (eds.), *Contrast and Representations in Syntax*, 138–178. Oxford: Oxford University Press.
- McGinnis, Martha & Jim Wood. To appear. Derivational morphology. In *Handbook of Distributed Morphology*, Available at <https://ling.auf.net/lingbuzz/005429>. Oxford University Press.
- McIntyre, Andrew. 2014. Constraining argument structure in nominalizations: The case of english *-er*. *Lingua* 141. 121–138.
- McIntyre, Andrew. 2018. Complex predicates and late argument merger. Manuscript, Humboldt-Universität zu Berlin.
- McKenzie, Andrew. 2018. Mediating relations and the semantics of noun incorporation. Manuscript, University of Kansas.
- Melloni, Chiara. 2010. Action nominals inside: lexical-semantic issues. In Monika Rathert & Artemis Alexiadou (eds.), *The semantics of nominalizations across languages and frameworks*, 141–168. Berlin: Walter de Gruyter.
- Melloni, Chiara. 2011. *Event and result nominals: A morpho-semantic approach* Bern, Switzerland. Peter Lang.
- Merchant, Jason. 2019. Roots don't select, categorial heads do: Lexical-selection of PPs may vary by category. *The Linguistic Review* 36(3). 325–341.
- Michelioudakis, Dimitris & Nikos Angelopoulos. 2019. Selecting roots: the view from compounding. *The Linguistic Review* 36(3). 389–410.
- Moskal, Beata. 2015. *Domains on the border: Between morphology and phonology*: University of Connecticut Doctoral Dissertation.



- Mourelatos, Alexander P. D. 1978. Events, processes, and states. *Linguistics and Philosophy* 2(3). 415–434.
- Myler, Neil. 2011. *Come the pub with me*: Silent TO in a Dialect of British English. *NYU Working Papers in Linguistics* 3. 120–135.
- Myler, Neil. 2013. On *coming the pub* in the North West of England: Accusative unaccusatives, dependent case and preposition incorporation. *Journal of Comparative Germanic Linguistics* 16(2-3). 189–207.
- Myler, Neil. 2014. *Building and Interpreting Possession Sentences*: New York University Doctoral Dissertation.
- Myler, Neil. 2016. *Building and interpreting possession sentences*. Cambridge, MA: MIT Press.
- Newmeyer, Frederick J. 2009. Current challenges to the lexicalist hypothesis. In William D. Lewis, Simin Karimi, Heidi Harley & Scott O. Farrar (eds.), *Time and Again: Theoretical Perspectives on Formal Linguistics In Honor of D. Terence Langendoen*, 91–117. Philadelphia/Amsterdam: John Benjamins.
- Nie, Yining. submitted. Voice morphology and the features of transitivity. <https://ling.auf.net/lingbuzz/003750>.
- Nóbrega, Vitor A. 2020. No escape from categorization: an insider's view of compounds. *Ilha do Desterro* 73. 103–126.
- Nóbrega, Vitor A & Phoevos Panagiotidis. 2020. Headedness and exocentric compounding. *Word Structure* 13(2). 211–249.
- Ntelitheos, Dimitrios. 2012. *Deriving Nominals: A Syntactic Account of Malagasy Nominalizations*. Leiden/Boston: Brill.
- Ntelitheos, Dimitrios & Katya Pertsova. 2019. Root and semi-phrasal compounds: A syntactic approach. *Proceedings of the Linguistic Society of America* 4(30). 1–14.
- Ntelitheos, Dimitris. To appear. A syntactic analysis of synthetic and phrasal compound formation in Greek. In Sumru Özsoy & Ayse Gürel (eds.), *Current issues in Mediterranean syntax*, .
- Oerhle, Richard T. 1976. *The grammatical status of the English dative alternation*: MIT Doctoral Dissertation.
- Orešnik, Janez. 1985. Modern Icelandic u-umlaut from the descriptive point of view. In Magnús Pétursson (ed.), *Studies in the Phonology and Morphology of Modern Icelandic*, 111–182. Hamburg: Buske.
- Ormazabal, Javier & Juan Romero. 2012. PPs without disguises: Reply to Bruening. *Linguistic Inquiry* 43. 455–474.
- Oseki, Yohei. submitted. Voice morphology in Japanese argument structures. <http://ling.auf.net/lingbuzz/003374>.
- Pakerys, Jurgis. 2006. Veiksmo pavadinimo konstrukcija lietuvių kalbos gramatikoje [Action noun constructions in Lithuanian grammar]. In Axel Holvoet & Rolandas Mikulskas (eds.), *Daiktavardinio junginio tyrimai: Lietuvių kalbos gramatikos darbai*, 121–149. Vilnius: Lietuvių kalbos instituto leidykla.
- Pesetsky, David. 1995. *Zero Syntax: Experiencers and Cascades*. Cambridge, MA: MIT Press.
- Pesetsky, David. 2013. *Russian Case Morphology and the Syntactic Categories*. Cambridge, MA: MIT Press.
- Petersen, Hjalmar P. 2016. The Spread of the Phrasal Clinic *sa* in Faroese. *Arkiv för nordisk filologi* 131. 105–128.
- Pfaff, Alexander. 2015. *Adjectival and Genitival Modification in Definite Noun Phrases in Icelandic: A Tale of Outsiders and Inside Jobs*: University of Tromsø Doctoral Dissertation.
- Picallo, M Carme. 1991. Nominals and nominalizations in Catalan. *Probus* 3(3). 279–316.
- Pitteroff, Marcel. 2014. *Non-canonical 'sich lassen' middles*.: University of Stuttgart Doctoral Dissertation.
- Pitteroff, Marcel. 2015. Non-canonical middles: A study of personal *let*-middles in German. *Journal of Comparative Germanic Linguistics* 18(1). 1–64.
- Pitteroff, Marcel & Artemis Alexiadou. 2012. On the properties of German *sich-lassen* middles. In Jaehoon Choi, E. Alan Hogue, Jeffrey Punske, Deniz Tat, Jessamyn Schertz & Alex Trueman (eds.), *Proceedings of the 29th West Coast Conference on Formal Linguistics*, 214–222. Somerville, MA: Cascadilla Proceedings Project.
- Platzack, Christer. 2006. Case as Agree marker. *Working Papers in Scandinavian Syntax* 77. 71–99.
- Port, Martin. 2008. Understood arguments and complex Logical Forms. In Michael Grosvald & Dianne Soares (eds.), *Proceedings of the 38th Western Conference on Linguistics*, 253–265. Fresno, CA: University of California.
- Pross, Tillmann. 2019. What about lexical semantics if syntax is the only generative component of the grammar? A case study on word meaning in German. *Natural Language & Linguistic Theory* 37(1). 215–261. doi:<https://doi.org/10.1007/s11049-018-9410-7>.
- Pylkkänen, Liina. 2002. *Introducing Arguments*: MIT Doctoral Dissertation.
- Pylkkänen, Liina. 2008. *Introducing Arguments*. Cambridge: MIT Press.
- Rappaport Hovav, Malka & Beth Levin. 2010. Reflections on manner/result complementarity. In Edit Doron, Malka Rappaport Hovav & Ivy Sichel (eds.), *Syntax, lexical semantics, and event structure*, 21–38. Oxford: Oxford University Press.
- Reuland, Eric. 2011. What's nominal in nominalizations? *Lingua* 121(7). 1283–1296.
- Rizzi, Luigi. 1986. Null objects in Italian and the theory of pro. *Linguistic Inquiry* 17(3). 501–557.

- Roeper, Thomas & Angeliek van Hout. 1999. The Impact of Nominalization on Passive, *-able*, and Middle: Burzio's Generalization and Feature-Movement in the Lexicon. *MIT Working Papers in Linguistics* 35. 155–211.
- Roeper, Thomas & Angeliek van Hout. 2009. The representation of movement in *-ability* nominalizations. Evidence for covert category movement, Edge phenomena, and local LF. In Anastasia Giannakidou & Monika Rathert (eds.), *Quantification, Definiteness and Nominalization*, 344–364. Oxford University Press.
- Rögnvaldsson, Eiríkur. 1981. U-hljóðvarp og önnur a-ö víxl í nútímaíslensku [U-umlaut and other a-ö shifts in modern Icelandic]. *Íslenskt mál og almenn málfræði* 3. 25–58.
- Roodenburg, Jasper. 2010. Plurality from a cross-linguistic perspective: the existence of plural argument supporting nominalizations in French. *Lingue e linguaggio* 9(1). 41–64.
- Roßdeutscher, Antje & Hans Kamp. 2010. Syntactic and semantic constraints on the formation and interpretation of *ung*-nouns. In Monika Rathert & Artemis Alexiadou (eds.), *The semantics of nominalizations across languages and frameworks*, 169–214. Berlin: Walter de Gruyter.
- Rothstein, Susan. 1992. Case and NP Licensing. *Natural Language & Linguistic Theory* 10. 119–139.
- Roy, Isabelle & Elena Soare. 2013. Event-related nominalizations. In Gianina Iordăchioaia, Isabelle Roy & Kaori Takamine (eds.), *Categorization and Category Change*, 123–152. Cambridge: Cambridge Scholar Publishing.
- Roy, Isabelle & Elena Soare. 2014. On the internal eventive properties of *-er* nominals. *Lingua* 141. 139–156.
- Rozwadowska, Bożena. 2020. Polish psych nominals revisited. In Artemis Alexiadou & Hagit Borer (eds.), *Nominalization: 50 Years on from Chomsky's Remarks*, 337–362. Oxford: Oxford University Press.
- Schäfer, Florian. 2008. *The Syntax of (Anti-)Causatives*. Philadelphia: John Benjamins.
- Schäfer, Florian. 2009. The causative alternation. *Language and Linguistics Compass* 3(2). 641–681.
- Schäfer, Florian. 2012. The passive of reflexive verbs and its implications for theories of binding and case. *Journal of Comparative Germanic Linguistics* 15. 213–268.
- Šereikaitė, Milena. 2020. *Voice and Case Phenomena in Lithuanian Morphosyntax*: University of Pennsylvania Doctoral Dissertation.
- Šereikaitė, Milena. 2021. Active Existential in Lithuanian: Remarks on Burzio's Generalization. *Linguistic Inquiry* 52(4). 747–789. [https://doi.org/10.1162/ling\\_a\\_00392](https://doi.org/10.1162/ling_a_00392).
- Šereikaitė, Milena & Jim Wood. 2020. Nominalizations of Ditransitive Verbs in Icelandic and Lithuanian. Talk given at University of Iceland, August 12.
- Sigurðsson, Einar Freyr. 2015. Particle incorporation, resultatives, and 're-' prefixation. Qualifying Paper, University of Pennsylvania.
- Sigurðsson, Einar Freyr. 2017. *Deriving case, agreement and voice phenomena in syntax*: University of Pennsylvania Doctoral Dissertation.
- Sigurðsson, Einar Freyr, Milena Šereikaitė & Marcel Pitteroff. 2018. The structural nature of non-structural case: On passivization and case in Lithuanian. *Proceedings of LSA* 3. 1–15.
- E.F. Sigurðsson, Einar Freyr & Jim Wood. 2021. On the implicit argument of Icelandic indirect causatives. *Linguistic Inquiry* 52(3). 579–625. doi:[url{https://doi.org/10.1162/ling\\_a\\_00384}](https://doi.org/10.1162/ling_a_00384).
- Sigurðsson, Halldór Ármann. 1989. *Verbal syntax and case in Icelandic*: Lund University Doctoral Dissertation.
- Sigurðsson, Halldór Ármann. 1991. Icelandic Case-marked PRO and the licensing of lexical arguments. *Natural Language & Linguistic Theory* 9(2). 327–363.
- Sigurðsson, Halldór Ármann. 1993. The structure of the Icelandic NP. *Studia Linguistica* 47(2). 177–197.
- Sigurðsson, Halldór Ármann. 2003. Case: Abstract vs. morphological. In Ellen Brandner & Heike Zinsmeister (eds.), *New perspectives on case theory*, 223–267. Stanford, CA: CSLI.
- Sigurðsson, Halldór Ármann. 2006. The Icelandic noun phrase: Central traits. *Arkiv för nordisk filologi* 121. 193–236.
- Sigurðsson, Halldór Ármann. 2012a. Case variation: Viruses and star wars. *Nordic Journal of Linguistics* 35(3). 313–342.
- Sigurðsson, Halldór Ármann. 2012b. Minimalist C/case. *Linguistic Inquiry* 43(2). 191–227.
- Sigurðsson, Halldór Ármann. 2019. Gender at the edge. *Linguistic Inquiry* 50(4). 723–750.
- Sportiche, Dominique, Hilda Koopman & Edward Stabler. 2014. *An introduction to syntactic analysis and theory*. Wiley-Blackwell.
- Steddy, Sam. 2019. Compounds, composability, and morphological idiosyncrasy. *The Linguistic Review* 36(3). 453–483.
- Stroik, Thomas. 1992. Middles and movement. *Linguistic Inquiry* 23(1). 127–137.
- Stroik, Thomas. 1999. Middles and reflexivity. *Linguistic Inquiry* 30(1). 119–131.
- Svenonius, Peter. 2001. Case and event structure. *ZAS Papers in Linguistics* 26. 1–21.

- Svenonius, Peter. 2002. Icelandic case and the structure of events. *Journal of Comparative Germanic Linguistics* 5(1/3). 197–225.
- Svenonius, Peter. 2004. Slavic prefixes inside and outside VP. *Nordlyd* 32(2). 205–253.
- Svenonius, Peter. 2005. The Nanosyntax of the Icelandic Passive. Paper presented at the Lund Grammar Colloquium. <https://www.academia.edu/download/30675856/IcelandicPassHO.pdf>.
- Svenonius, Peter. 2006. Case alternations and the Icelandic passive and middle. In Satu Manninen, Diane Nelson, Katrin Hiietam, Elsi Kaiser & Virve Vihman (eds.), *Passives and Impersonals in European Languages*, Amsterdam: John Benjamins. <http://goo.gl/Ihgh4S>.
- Svenonius, Peter. 2012. Spanning. Manuscript, CASTL, University of Tromsø. <https://ling.auf.net/lingbuzz/001501>.
- Svenonius, Peter. 2016. Spans and words. In Daniel Siddiqi & Heidi Harley (eds.), *Morphological metatheory*, 201–236. Philadelphia/Amsterdam: John Benjamins.
- Szabolcsi, A. 1983. The possessor that ran away from home. *The Linguistic Review* 3(1). 89–102.
- Szabolcsi, Anna. 1994. The noun phrase. In Ferenc Kiefer & Katalin É. Kiss (eds.), *The Syntactic Structure of Hungarian*, 179–274. New York: Academic Press.
- Þorgeirsson, Haukur. 2012. Getum við lært eitthvað af Aröbnum? Enn um a/ö-víxl í íslensku [Learning from the Arabs: On a/ö-alternations in Icelandic]. *Íslenskt mál og almenn málfraði* 34. 127–138.
- Thorvaldsdóttir, Thorbjörg. 2019. Agreement with conjoined singular noun phrases in Icelandic. *Glossa* 4(1). 1–33.
- Thráinsson, Höskuldur. 2007. *The Syntax of Icelandic*. Cambridge: Cambridge University Press.
- Torfadóttir, Theódóra A. 2008. Event Typology and Aspectual Classes in Icelandic. Manuscript, University of Iceland.
- Tungseth, Mai Ellin. 2007. Benefactives across Scandinavian. *Working Papers in Scandinavian Syntax* 80. 187–228.
- Tyler, Matthew. 2020. *Argument Structure and Argument-marking in Choctaw*: Yale University Doctoral Dissertation.
- Tyler, Matthew. 2021. Two Kinds of External Possession in Mississippi Choctaw. *Syntax* 24(1). 78–122.
- Valfell, Sigríður. 1967. „Umlaut“-Alternations in Modern Icelandic: Harvard University Doctoral Dissertation.
- Vangsnes, Øystein Alexander. 1999. *The identification of functional architecture*: University of Bergen Doctoral dissertation.
- Vladarskienė, Rasuolė. 2010. Linksnų vartojimas veiksmažodžių abstraktų junginiuose [The use of cases in abstract phrases of verbal nouns]. *Kalbos Kultūra* 83. 173–184.
- Whelpton, Matthew. 2007. Building resultatives in Icelandic. *Proceedings of the 34th Western Conference on Linguistics* 34. 478–486.
- Whelpton, Matthew & Heidi Harley. 2016. Pseudopartitive compounds in Icelandic. Paper presented at Synsalon, Feb. 2016, University of Arizona.
- Wood, Jim. 2009a. Icelandic imposters and the proprial article. In Patricia Irwin & Violeta Vázquez Rojas (eds.), *NYU Working Papers in Linguistics*, vol. 2, New York: NYU.
- Wood, Jim. 2009b. Two Icelandic prefixes as diagnostics for argument structure. Paper presented at the SunyYaleNyu-Cuny (SYNC) mini-conference.
- Wood, Jim. 2012. *Icelandic Morphosyntax and Argument Structure*: New York University Doctoral Dissertation.
- Wood, Jim. 2013. The unintentional causer in Icelandic. In Yelena Fainleib, Nicholas LaCara & Yangsook Park (eds.), *Proceedings of the Forty-First Annual Meeting of the North East Linguistic Society*, vol. II, 273–286. Amherst, MA: GLSA Publications.
- Wood, Jim. 2015. *Icelandic Morphosyntax and Argument Structure*. Dordrecht: Springer.
- Wood, Jim. 2016. How roots do and don't constrain the interpretation of Voice. *Working Papers in Scandinavian Syntax* 96. 1–25.
- Wood, Jim. 2017. The Accusative Subject Generalization. *Syntax* 20(3). 249–291.
- Wood, Jim & Inna Livitz. 2012. What isn't an oblique subject in Icelandic and Russian? Paper presented at *Non-Canonically Case-Marked Subjects within and across Languages and Language Families: Stability, Variation and Change*, University of Iceland, June 5th, 2012. <http://goo.gl/0qrVXH>.
- Wood, Jim & Alec Marantz. 2017. The interpretation of external arguments. In Roberta D'Alessandro, Irene Franco & Ángel J. Gallego (eds.), *The verbal domain*, 255–278. Oxford: Oxford University Press.
- Wood, Jim & Einar Freyr Sigurðsson. 2014. Building deverbal ability adjectives in Icelandic. *University of Pennsylvania Working Papers in Linguistics* 20(1). 351–360.
- Wood, Jim, Einar Freyr Sigurðsson & Raffaella Zanuttini. 2015. Partitive Doubling in Icelandic and Appalachian English. In Thuy Bui & Deniz Özyıldız (eds.), *Proceedings of the Forty-Fifth Annual Meeting of the North East Linguistic Society*, vol. III, 217–226. Amherst, MA: GLSA Publications.

- Wood, Jim & Halldór Ármann Sigurðsson. 2014. *Let*-causatives and (a)symmetric DAT-NOM constructions. *Syntax* 17(3). 269–298.
- Wood, Jim & Catarina Loureiro Soares. 2021. The construction and interpretation of *-væða* verbs and *væðing* nouns. Manuscript, Yale University.
- Wurmbrand, Susi. 2015. Complex predicate formation via voice incorporation. In Léa Nash & Pollet Samvelian (eds.), *Approaches to Complex Predicates*, 248–290. Leiden: Brill.
- Zhang, Niina Ning. 2007. Root merger in Chinese compounds. *Studia Linguistica* 61(2). 170–184.