

Predicate raising and V1 orders in Interior Tsimshianic

Clarissa Forbes

Sep 30, 2020

Abstract. This paper presents an analysis of VSO and VOS word orders in the Interior Tsimshianic (IT) languages of British Columbia, Canada: Nisga'a and Gitksan. Both varieties exhibit base VSO order with a VOS variant in noun incorporation. In addition, Nisga'a exhibits a second VOS construction whereby participant object pronouns obligatorily appear adjacent to the verb. I present an account of all three verb-initial orders in IT as broadly derived via predicate-raising, whereby the majority of phrasal arguments and adjuncts are base-generated external to the predicate (Massam 2020). I analyze the first VOS order as pseudo-incorporation, where O exceptionally merges ν P-internally. I analyze the second VOS order as one where O merges ν P-externally as usual, but is subject to a later reordering condition after it has been licensed.

The morphologically-rich IT verb/predicate overtly distinguishes the proposed ν P-internal and ν P-external object positions: objects which have pseudo-incorporated clearly differ from those which are merely verb-adjacent. This challenges analyses which derive pseudo-incorporation via adjacency (e.g. Clemens 2019). A final consideration of the morphology of passivization and antipassivization in pseudo-incorporation also provides insight into the internal structure of the IT predicate, demonstrating that some verbal suffixes attach to the PNI object, and suggesting that antipassives may be derived PNI constructions.

'Wii t'isim ha'miyyaa 'nii'y alooos Barbara Sennott (Harris), Vince Gogag, Hector Hill, and Louise Wilson, as well as the others I have worked with on the *laxyip*, for sharing their knowledge, language, and culture with me. The Gitksan examples are from my primary fieldwork with these language experts since 2011. Further thanks to the UBC Gitksan Lab for continued support with elicitation and data sharing. All errors are my own. This research is supported by a SSHRC Postdoctoral Award and by the Jacobs' Research Fund.

1. Introduction

Verb-initial (V1) word orders occur in roughly 10% of the world's languages. Within generative syntax, a variety of analyses have been proposed to derive V1 orders (Carnie & Guilfoyle 2000; Carnie et al. 2005). While V1 languages usually share certain clusters of properties, suggesting they are prototypically head-initial, it is largely accepted that there is no common means of arriving at VSO or VOS order for all languages that exhibit it.

This paper presents an analysis of VSO and VOS word orders in the Tsimshianic family of British Columbia, Canada, with specific focus on the two mutually-intelligible varieties of the Interior branch: Nisga'a and Gitksan. These languages exhibit default VSO order, as illustrated in (1a), as well as a marked VOS alternation given in (1b). Nisga'a in particular exhibits a second marked VOS order, presented in (1c).¹

- (1) a. Hlimoomis Maryhl gimxdit.
 hlimoom-i-t[=s Mary][=hl gimxdi-t]
 help-TR-3.II[=PN Mary][=CN opp.sex.sibling-3.II]
 'Mary helped her brother.' → VSO *Nisga'a* (Tarpent 1987:235)
- b. K'ohlhoon 'nii'y.
k'ohl-hoon 'nii'y
 gut-fish 1SG.III
 'I gutted fish.' → VOS *Nisga'a* (Tarpent 1987:792)
- c. Hlimoomit 'nii'yhl hlixhlgiiiksi'y.
 hlimoom-i-t 'nii'y[=hl hlixhlgiiiksi-'y]
 help-TR-3.II 1SG.III[=CN woman's.sister.PL-3.II]
 'My sisters helped me.' → VOS *Nisga'a* (Tarpent 1987:234)

The VOS construction in (1b) occurs in prototypical noun-incorporation contexts in both Gitksan and Nisga'a, and is grammatically intransitive. The VOS construction in (1c) occurs in Nisga'a

¹Examples are labeled with their source language, and are from the author's own fieldwork or are explicitly cited with the original source. Glosses in examples have typically been modified from the original source and standardized to the following set of abbreviations: I = series I clitic, II = series II suffix, III = series III full pronoun, 1 = first person, 2 = second person, 3 = third person, ANTIP = antipassive, ATTR = attributive, AX = agent extraction, CAUS = causative, CCNJ = clausal conjunction, CN = common noun determiner, COMP = complementizer, DETR = detransitive, EPIS = epistemic, FOC = focus, IPFV = imperfective, NACT = non-active, NEG = negative, OBL = oblique, PASS = passive, PL = plural, PN = proper noun determiner, PREP = preposition, PROSP = prospective, REPORT = reportative, SG = singular, SX = intransitive subject extraction, TR = transitive.

when a first or second person (henceforth, *participant*) pronoun is in object position, and is grammatically transitive.

I present a predicate-raising account of Interior Tsimshianic (IT) clause structure that effectively derives all three of these constructions, contra early work on IT adopting a V° -movement approach (Hunt 1993). I specifically adopt a structure following Massam (2020), where phrasal arguments and adjuncts merge outside ν P, after the simple or complex predicate has been constructed in its entirety. That is, syntactically-licensed arguments in IT are base-generated outside the predicate, while pseudo-incorporated arguments are base-generated inside. I demonstrate how this successfully derives both syntactic and morphological properties of both standard and incorporating clauses in IT, and how competing approaches which utilize argument-movement from the ν P or prosodic reordering of arguments fail to do so (e.g. Massam 2000; Madeiros 2013; Clemens 2019). I finally propose that the unusual participant-based VOS order found in Nisga'a is an example of strictly prosodic reordering; participant objects are subject to both syntactic licensing and 'licensing under adjacency'.

The morphologically-rich IT predicate provides novel insight into the difference between verbal incorporation and verbal adjacency, with the position of inflectional suffixes serving as a diagnostic for the object's ν P-internal or -external position. Morphologically-incorporated objects are exempt from syntactic licensing and exhibit the interpretive effects of semantic incorporation, while objects that are simply verb-adjacent behave as normal transitive objects. Other operations such as causativization, passivization, and antipassivization are also marked by suffixation, and shed even greater light on the precise relation between the predicate and its incorporated versus non-incorporated object.

I begin in section 2 with a brief background of Nisga'a and Gitksan and their relevant morphosyntactic properties, and review the V1 constructions under investigation in more detail. In section 3 I review existing analyses of V1 orders, and demonstrate that IT exhibits some properties consistent with a V° -movement, and others consistent with ν P-remnant raising. I ultimately argue for a predicate-raising analysis with ν P-external argument merge following Massam (2020).

In section 4 I implement this analysis for both basic VSO clauses and pseudo-incorporating VOS clauses. Section 5 considers the transitive VOS construction in Nisga'a, arguing that this type of VOS, in contrast to the other, is best achieved through movement outside of *vP*. Finally, section 6 explores the internal structure of the IT *vP* in more detail by examining the result of morphological causativization, passivization, and antipassivization as applied to pseudo-incorporating predicates with *vP*-internal objects. The data raise broader questions for our understanding of head movement and morpheme ordering. Section 7 concludes.

2. Language background

The small Tsimshianic family is located mainly in what is now called British Columbia and a small way across the border into southern Alaska. The family is a continuum of related dialects spoken along the watershed of the Skeena and Nass Rivers, and the surrounding Pacific coastline. The dialects are grouped into four recognized languages, and organized into two branches, Interior and Maritime; in this paper I focus on the languages of the Interior branch, Nisga'a and Gitksan (jointly IT, for Interior Tsimshianic). These varieties are mutually intelligible but culturally and politically distinct (Rigsby 1986), and they are highly endangered (Nisga'a: 331 speakers, Gitksan: 523 speakers; Dunlop et al. 2018).

2.1 Interior Tsimshianic morphosyntax

Nisga'a and Gitksan are morphologically 'in the middle': they are head-marking, fusional, and synthetic, but not to the polysynthetic extreme. They exhibit both prefixes and suffixes. These languages are quite prototypical V1 languages with respect to several properties noted by Clemens & Polinsky (2017). They have no overt finite/nonfinite contrast, no overt copula, no verbal HAVE predicate, and no double-object constructions. They also exhibit ergative alignment, and *wh*-words appear clause-initially in *wh*-questions.

The Tsimshianic languages all exhibit a fundamental split in the agreement patterns of the independent versus dependent order. Independent-order clauses are, broadly, unsubordinated clauses; dependent-order clauses are those which are subordinated under a wide variety of functional el-

ements, including aspect markers, negation, modals, complementizers, and conjunctions. Both clause types exhibit base VSO word order, but differ in terms of their agreement marking. Independent clauses, demonstrated in (2), have one agreement marker: a verbal suffix (Series II) indexing ergative arguments. Dependent clauses, demonstrated in (3), have two agreement markers: an ergative preverbal clitic (Series I), and the same Series II verbal suffix, which now switches to indexing either absolutes or nominatives, based on the features of the subject (Hunt 1993; Forbes 2018, to appearb).²

(2) Independent order

- a. Bax̣ 'nii'y.
 bax̣ 'nii'y
 run 1SG.III
 'I ran.'
- b. Iileni'y 'nit.
 hilen-i-'y 'nit
 chase-TR-1SG.II 3.III
 'I chased him/her.'

Gitksan

(3) Dependent order

- a. Needii bax̣a'y.
 nee=dii bax̣-'y
 NEG=FOC run-1SG.II
 'I ran.'
- b. Neediin iilent.
 nee=dii=n hilen-t
 NEG=FOC=1.I chase-3.II
 'I didn't chase him/her.'

Gitksan

Lexical DP arguments co-occur with coreferent agreement markers, but pronoun arguments are in complementary distribution with co-referent agreement markers, in a pattern also seen in the

²The *Series I/Series II* labels are from Rigsby (1986), and are based on their linear order in the sentence. The Series I preverbal clitics are almost exclusively ergative, but the Series II suffixes have a variety of functions depending on the context, including both ergative and absolutive. I mark the I/II/III tags in glosses for reference, since the paradigms cannot be consistently associated with a specific alignment—particularly the suffixal series II set.

Celtic languages.³ In this paper’s discussion of word order, I refer only to the order of lexical and pronominal DPs, not the linear order of agreement affixes. One relevant consequence of pronoun-agreement complementarity is that we cannot detect the linear position of pronouns that have agreed, as they are realized only as *pro* (as illustrated in the examples in (3), where all arguments agree). That is, we can only discuss the surface position of non-agreeing pronouns. This limits the scope of possible discussion with respect to the word order of pronoun arguments: the relative order of subject and object in a sentence with two pronouns can never be determined, since the transitive subject always agrees and surfaces only as *pro* (as in (2b)).

2.2 *Basic VSO order*

The order of lexical argument DPs can be identified without issue in any clause type, and it is consistently VSO. This order holds strictly regardless of whether the object is a full noun or pronoun (compare the sub-examples in (4)), and regardless of the clause type or presence of subordinators (compare independent (4) and dependent (5)).

- (4) a. Hlimoomis Annt John.
 hlimoom-i-t=s Ann=t John
 help-TR-3.II=PN Ann=PN John
 ‘Ann helped John.’
- b. Hlimoomihl hanak’hl gat.
 hlimoom-i-t=hl hanak’=hl gat
 help-TR-3.II=CN woman=CN man
 ‘The woman helped the man.’
- c. Hlimoomihl gat ’nidiit.
 hlimoom-i-t=hl gat ’nidiit
 help-TR-3.II=CN man 3PL.III
 ‘The man helped them.’

Nisga’a (Jelinek 1986:2-3)

- (5) a. Luu’aamhl goott [wilt hlimooms Mary ’nit.]
 luu-aam=hl goot-t wil=t hlimoom-t=s Mary ’nit
 in-good=CN heart-3.II COMP=3.I help-3.II=PN Mary 3.III

³This is not always surface apparent due to the enclitic property of common and proper noun determiners. I assume, following discussion by [Tarpent \(1987\)](#), [Davis & Forbes \(2015\)](#), [Davis \(2018\)](#), and [Forbes \(2018\)](#), that suffixal agreement is only surface-obscured behind the determiner clitics, but does take place in the syntactic component; this is made explicit in the four-line gloss this paper adopts for examples.

‘He is happy that Mary helped him.’

- b. ... wilt hlimooms Maryt Bill.
 ... wil=t hlimoom-t=s Mary=t Bill
 ... COMP=3.I help-3.II=PN Mary=PN Bill
 ‘... that Mary helped Bill.’

Nisga’a (Jelinek 1986:7-8)

Deviations from VSO order occur only under specific circumstances. SVO and OVS orders are the result of argument A'-extraction under focus or topicalization (see Tarpent 1987; Davis & Brown 2011; Brown 2016). VOS orders arise in two specific contexts.

2.3 VOS constructions

The first context producing VOS order, holding consistently across the Tsimshianic family, is object incorporation (Tarpent 1987; Rigsby 1986; Sasama 2001). Incorporation is typically possible for indefinite objects in common phrases about food preparation or household tasks. The process is not fully productive; that is, incorporation is not a broad strategy to express object indefiniteness (Rigsby 1986; Tarpent 1987). Example (6a) illustrates a transitive VSO sentence; (6b) illustrates its incorporated counterpart, which appears in VOS order.

- (6) a. K'ohli'yhl **hoon**.
 k'ohl-i-'y=hl hoon
 gut-TR-1SG.II=CN fish
 ‘I gutted a/the fish.’
- b. K'ohl**hoon** 'nii'y.
 k'ohl-hoon 'nii'y
 gut-fish 1SG.III
 ‘I gutted fish.’

Nisga’a (Tarpent 1987:791-2)

The two sentences differ not only in their word order but also their transitivity. The first person object of (6a) is expressed with the here ergative-patterning verbal suffix; in (6b), it is expressed with an absolutive pronoun. The incorporation sentence also lacks a transitive marker on the stem. When the object is incorporated and in its verb-adjacent position, it fails to contribute to the transitivity of the sentence. It also lacks any connective marker to indicate its common/proper

status (e.g. =hl in (6a)); these are obligatory on all other arguments, and I treat them as determiners.

Intransitive verbs in dependent clauses inflect with an absolutive suffix. Of interest is the position of the incorporated object with respect to this verbal suffix. The examples (7) and (8) demonstrate that in dependent clauses, the verbal agreement suffix attaches to the entire verb-object complex, on the right edge of the object nominal.

- (7) *Getxwhl loo'y ahl dim t'aahl miyehli'y.*
getxw=hl loo-'y a=hl dim t'aahl-miyehli-'y
 hard=CN OBL-1SG.II PREP=CN PROSP pick-blueberries-1SG.II
 'It's hard for me to pick blueberries.' *Gitksan*

- (8) *Yukwhl hisyetslekws John.*
yukw=hl yets~yets-lekw-t =t John
 PROG=CN PL~chop-firewood-3.II =PN John
 'John was chopping wood.' *Gitksan*

For both syntactic and morphological purposes, then, the verb and object seem to behave as a single constituent.

While the majority of this paper focuses on the incorporation construction, an interesting contrast is provided by a second, crosslinguistically unusual VOS construction found in Nisga'a, but not Gitksan.⁴ This occurs when the object is a speech-act participant. While third-person pronominal objects appear in VSO order, as in (9a), participant objects appear in VOS order, as in (9b).⁵

- (9) a. *Hlimoomis Ann 'nit.*
hlimoom-i-t =t Ann 'nit
 help-TR-3.II =PN Ann 3.III
 'Ann helped her.'

⁴In Gitksan, these VOS constructions are accepted but almost never volunteered. Rigsby (1986, 263) notes that the VOS order is the older form; speakers seem to have leveled to the VSO order across all contexts.

⁵The relative order of subject and object can only be concretely identified when the subject is overt; that is, when it is a lexical DP. Recall that if the subject is a pronoun then agreement requires it to surface as *pro*, and word order is simply V-agr O. It is consequently indeterminable whether the word order alternation is conditioned by the participant status of the object alone, or more specifically by a participant object under a third-person subject (as suggested by the label 'word order inverse' given for similar patterns by Givón 1994).

- b. Hlimoomit 'nii'y t Ann.
 hlimoom-i-t 'nii'y t Ann
 help-TR-3.II 1SG.III PN Ann
 'Ann helped me.'

Nisga'a; (Jelinek 1986:9)

The transitive and ergative inflection that appears on the verb in (9b) clearly demonstrates that this VOS clause is transitive, in stark contrast to the incorporation-VOS clause in (6b) which bears none of these markers. The object in this construction is simply adjacent rather than incorporated.

This latter construction is discussed in more detail in section 5, where I demonstrate that it patterns for all intents and purposes like a regular transitive clause. For now we turn to a general analysis of verb-initial word order in IT, with particular attention paid to the basic VSO order and the incorporated VOS order.

3. Analyses of V1 order

A number of analyses have been proposed over the years to account for verb-initial VSO and VOS word orders (Carnie & Guilfoyle 2000; Carnie et al. 2005; Clemens & Polinsky 2017). The two most prominent families of analyses are head-raising approaches where V° raises above the final landing sites of the subject and object (Carnie et al. 2000), and predicate-raising approaches where what raises is a larger verbal constituent such as vP itself (Massam 2000, 2020).⁶ Early accounts of Interior Tsimshianic VSO clause structure adopt either a V° -movement account (Belvin 1985; Hunt 1993) or a pronominal-argument approach (Jelinek 1986; Tarpent 1988).⁷ More recently, Forbes (2018) suggests a classic predicate-raising account following Massam (2000).

Predicate-raising analyses excel at capturing VSO-VOS word-order alternations between standard and incorporated clauses (e.g. Massam 2000, 2001; Coon 2010). Under the standard remnant-raising approach, a verbal constituent is raised to the specifier of a higher functional projection in

⁶Another family of approaches adopts rightward specifiers (Aissen 1992; Chung 1998). I do not consider this style of analysis here, as it is better suited for languages where VOS is the more basic or common word order.

⁷The pronominal-argument approach is argued against first by Belvin (1985) and then more extensively by Hunt (1993), on the basis that any subject-object asymmetry falsifies an analysis where both are assumed to be adjuncts. Interior Tsimshianic has several such asymmetries: strict VSO order is the most obvious, followed by the object-centric nature of noun incorporation, and existence of weak crossover effects. Assuming that these languages are configurational, then, it still remains to be clearly demonstrated whether they are better accommodated under V° - or predicate-raising.

the clause, typically T or Infl, to satisfy the EPP. This constituent may or may not contain an overt object. In the typical VSO clause, the DP object evacuates the verbal constituent before predicate-raising takes place, to a projection below the final position of the subject, generally for the purpose of case-licensing.⁸ This results in a VSO order as in (10a). In contrast, the bare NP object of an incorporation construction remains in situ within this verbal constituent, and is pied-piped to spec-IP, resulting in a VOS order as in (10b).

(10) VSO/VOS alternations via remnant-raising

- a. IP[_{VP}[V *t*_O] Infl ... S ... **O** ... *t*_{VP}]
- b. IP[_{VP}[V **O**] Infl ... S ... *t*_{VP}]

More recently, [Massam \(2020\)](#) presents an alternative predicate-raising account involving two distinct base positions for the object: one predicate-internal, and one predicate-external. Regardless of which position the object surfaces in, the predicate raises above the subject. If the object was merged predicate-externally, then the result is VSO order as in (11a); if the object was merged predicate-internally, as in pseudo-incorporation, then the result is VOS order as illustrated in (11b). This approach differs minimally from the remnant-raising approach, with the object's position alternating based on its merge position rather than movement. As there is no movement from *v*P, there is consequently no *v*P 'remnant'.

(11) VSO/VOS alternations via predicate-raising

- a. IP[_{VP}[V *pro*_i] Infl ... S ... **O**_i ... *t*_{VP}]
- b. IP[_{VP}[V **O**] Infl ... S ... *t*_{VP}]

In addition, [Clemens \(2014, 2019\)](#) argues that VSO/VOS alternations can be derived from structures where V^o head-moves to a position above the subject. She argues that VOS order in

⁸Several variations on this analysis have been proposed which eschew case-licensing as the motivation for object movement, instead drawing properties of the linearization algorithm to pronounce predicate-internal phrasal elements in positions following the subject ([Madeiros 2013](#); [van Urk 2019](#)). I point out a potential problem faced by this type of analysis as applied to IT in section 3.2.

pseudo-incorporation is the consequence of prosodically-conditioned movement of an NP object to a verb-adjacent position as in (12b); DP objects resist such reordering as in (12a) (see also [Clemens & Coon 2018](#), for Mayan languages). VOS order can also result from rightward extraposition of the subject, as in (12c).

(12) VSO/VOS alternations via prosodic movement

IP[V-*v*-Infl _{vP}[S *t_v* _{vP}[*t_V* O]]]

- a. PF: V-*v*-Infl ... S ... **O**
- b. PF: V-*v*-Infl **O** ... S
- c. PF: V-*v*-Infl ... **O** ... S_(extraposed)

Both head-movement and predicate-raising analyses are therefore possible candidate structures for generating VSO and VOS alternations.

In what follows, I demonstrate that the Interior Tsimshianic languages exhibit a mixed set of properties which are partially, but not totally, consistent with either a V^o-raising or a *vP*-remnant-raising analysis. Rather, I argue that the data is consistent with precisely the predictions of [Massam's \(2020\)](#) predicate-raising analysis, whereby the object has two possible merge positions.

3.1 Properties consistent with a remnant-raising analysis

The main IT data consistent with the predictions of a predicate-raising approach arises from noun incorporation, which behaves as expected of NP pseudo-incorporation ([Massam 2001](#)) rather than N^o-incorporation ([Baker 1988](#)). Under the Mirror Principle, we expect the roll-up movement of lower heads to higher positions to result in rightward suffixation of the higher heads (e.g. V-*v*-Infl order). Thus in N^o-incorporation, we expect the complement N to move to V, with V suffixing (e.g. N-V order). However, in Nisga'a and Gitksan, the actual order of noun-incorporation is V-N, reflecting the expected [V Obj] order of a head-initial VP without movement, rather than the Obj-V order of leftward head-adjunction. An example is repeated in (13).

- (13) K'ohlhoon 'nii'y.
 k'ohl-hoon 'nii'y
 gut-fish 1 SG.III
 'I gutted fish.' (from (6b))

Second, it is possible for the incorporated object in IT to be complex. This is illustrated in (14a) with a simplex adjectival 'prenoun' modifier *k'uba* 'small (PL)', and in (14b-c) with overtly attributivized nouns.⁹

- (14) a. K'ohlim k'uba hun 'nii'y.
 K'ohl-m k'uba hun 'nii'y
 gut-ATTR small.PL fish 1 SG.III
 'I cut the small fish.'
- b. Yats lagwa sginisdin.
 yats lakw-a sginist-n
 chop firewood-ATTR pine-2SG.II
 '(Go) chop pine wood!'
- c. Jebasxum hat'e'lim 'mel 'nii'y.
 jep-asxw-m hat'e'l-m 'mel 'nii'y
 make-ANTIP-ATTR cedar-ATTR canoe 1 SG.III
 'I built cedar canoes.' *Gitksan*

This is consistent only with the predictions of pseudo-incorporation whereby the incorporated object is a full NP, rather than head-incorporation of a minimal N°.

The other critical data favoring a predicate-raising approach comes from the behavior of verbal modifiers. Under a head-movement approach, the only elements that are predicted to move are V° and the functional heads it attaches to through roll-up movement. Non-head material—that is, the phrasal argument O, but also adverbial modifiers—would be predicted to remain in situ, and therefore in a post-verbal position, as illustrated in (15a). By contrast, under a predicate-raising analysis, low modifiers are predicted to be pied-piped along with V° within the raised predicate, and therefore may surface pre-verbally, as in (15b).

⁹These examples also illustrate a degree of the morphological complexity possible in the incorporation construction: the antipassive and/or attributive morphemes may be used. This is discussed further in section 6's more detailed review of complex incorporation constructions.

- (15) a. V°-MOVEMENT: IP[V-*v*-Infl _{VP}[S *t_V* _{VP}[**adv** *t_V* O]]]
 b. VP-MOVEMENT: IP[_{VP}[**adv** V ... *t_O*] Infl ... S ... O ... *t_{VP}*]

The Tsimshianic languages have a wide array of low adverb-like elements and verbal modifiers, including prototypically low manner-, position-, and path-denoting adverbials such as *luu* ‘in’ or *suwi* ‘away, off’; but also expressions which might be analyzed as restructuring verbs (though they have no main verb counterparts), such as *si’ix* ‘try’. In the Tsimshianic literature, these elements are traditionally called proclitic particles or preverbs, and they are prosodically phrased with the verb (Boas 1911; Rigsby 1986; Tarpent 1987). Examples are illustrated in (16) and (17).

- (16) Ii ’niiwin hediit loo’m dim hogagam si’ix luu t’aahl
 ii ’niiwin he-diit loo-’m [dim **hogax-m** **si’ix luu** t’aa-t=hl
 CCNJ then say-3PL.II OBL-1PL.II [PROSP be.correct-ATTR try in sit-3.II=CN
 goodi’m.
goot-’m]
 heart-1PL.II]
 ‘And they told us that we are to be in our right mind.’

(Lit: ...that our hearts should try to sit within (us) properly)

Gitksan

- (17) T’ek’il suwi k’ee_xwhl xpts’ewit hlgu gyet.
t’ek’il **suwi** k’ee_x-xw=hl xpts’exw-it hlgu gyet
 curled.up away flee-NACT=CN afraid-SX little man
 ‘The frightened little guy took off right away.’

Gitksan

To be more precise, *all* morphemes involved in the composition of the Tsimshianic predicate appear within or preceding the verb word; there are no adverbials or particles whatsoever which intervene between V and S, or between S and O, as would be expected under the V°-movement approach.¹⁰ I assume henceforth that preverbs are either adverbial, or are functional heads located higher than the verb is able to move.

Under a predicate-raising approach, adverbial material—and even immediately c-commanding functional heads—are predicted to raise along with the verb in accordance with the size of the

¹⁰The only verbal/clausal morphemes which occur postverbally are clearly semantically high: epistemic clitics, temporal adverbs, and final discourse particles.

constituent that moves. The Tsimshianic data is consistent with the idea that a large verbal constituent raises above the arguments, pied-piping all elements of the complex predicate including its adverbial modifiers, just as it is able to pied-pipe an NP object. The predicate-raising approach consequently provides a natural explanation for both the strictly pre-verbal position of low modifiers and their prosodic phrasing: the predicate, inclusive of both heads and modifiers, remains a constituent throughout the derivation, even after moving above the arguments, and shipping to PF.

3.2 *Properties consistent with a head-movement analysis*

There are also several facts in IT that conversely suggest a V° -movement analysis of VSO order. The first is merely suggestive: as the reader may have already noticed, the IT verb is often syntactically complex, and may bear a number of argument-structural suffixes and agreement, as illustrated in (18) and (19).

- (18) Huxwdii jiksintxwhl ksuu'w.
 huxw=dii jiks-**in-xw-t**=hl ksuu'w
 also=FOC wet-CAUS-NACT-3.II=CN hemlock.bark
 'The ksuu'w (hemlock inner bark) is also moistened.' *Gitksan* (Forbes 2019b, 78)
- (19) Gaxgu wil luuyaltgwin?
 gaxgu wil luu-**yal-kw-n**
 when COMP in-return-NACT-2SG.II
 'When did you come back?' *Nisga'a* (Tarpent 1987, 280)

These suffixes, which seem to appear in an order respecting the Mirror Principle, suggest a degree of rollup head-movement. Languages which have previously received detailed treatments under a predicate-raising analysis are commonly less agglutinative, or even totally isolating (e.g. Niuean; Massam 2000, 2020).

The second collection of points is more complex but also more conclusive. The V° -movement and predicate-raising approaches make divergent predictions about the position and accessibility of phrasal elements in the clause. With regards to position, head-movement approach predicts that all phrases and arguments are in situ; only the verb moves, so we expect things like prepositional

phrases to appear quite low. In contrast, the remnant-movement approach predicts that arguments and phrases within the domain of the predicate are either pied-pied within the raised predicate, or else independently move out of the predicate phrase to some higher position. Depending on the anticipated size of the raised verbal constituent, this predictions holds of both direct and indirect objects, prepositional phrases, and CP arguments.

The application of this prediction to PPs and CPs is a noted problem for the typical predicate-raising approach, since in [Massam's \(2000\)](#) original proposal arguments vacate the predicate in order to receive Case. Since PPs and CPs do not need Case, we expect that PP and CP elements within the predicate should be raised with the predicate, and appear preceding the subject. Some languages for which a predicate-raising analysis has been proposed do demonstrate pied-piping of IOs over the subject along with the predicate (particularly VOS-dominant languages e.g. Malagasy; [Paul 2000](#); [Clemens & Polinsky 2017](#)); however, for others including Nisga'a and Gitksan, all phrasal elements follow the subject and object in VSOX order, whether they are IOs, other PPs, or CP complements. This is illustrated in (20). That is, in IT, the only phrasal element that it is possible to overtly pied-pipe with the predicate is an incorporated NP object; no DP, CP, or PP overtly remains within the fronted verbal constituent.

(20) Gi'namis Peterhl ts'iksna'aks as Mary.
 gi'nam-i-t=s Peter=hl ts'iksna'aks [a-t=s Mary]
 give-TR-3.II=PN Peter=CN bracelet PREP-3.II=PN Mary
 'Peter gave Mary a/the bracelet.' *Nisga'a* ([Tarpent 1987](#), 276)

(21) K'ayim t'aahl ansee'lipt ahl awa'ahl amhaats'.
 k'ayim t'aa=hl ansee'lip-t [a-t=hl awa'a-t=hl amhaats']
 near sit=CN firepit-3.II PREP-3.II=CN vicinity-3.II=CN uprooted.tree
 'His firepit was right next to (the roots of) an uprooted tree.' *Nisga'a* ([Tarpent 1987](#), 403)

(22) Ga'as Mary wil wokhl maaxwsxwa duus.
 ga'a-i-t=s Mary [wil wok-t=hl maaxwsxw-a duus]
 see-TR-3.II=PN Mary COMP sleep-3.II=CN white-ATTR cat
 'Mary saw the white cat sleeping.' *Gitksan*

Some authors have suggested alternate means of causing phrasal elements to vacate the predicate

so as to produce VSOX order, such as by stating that the movement of phrases from the predicate is post-syntactic rather than in the syntax proper (Madeiros 2013; van Urk 2019). That is, DP, PP, and CP elements remain within the predicate syntactically, but are linearized outside it. However, such accounts still face the following subsidiary problem regarding argument accessibility.

As pointed out by Clemens & Polinsky (2017), we expect that raised constituents such as the predicate phrase should become islands from which sub-extraction is impossible, under the Freezing Principle (Ross 1974; Wexler & Culicover 1977). Under remnant-raising, then, phrases pied-piped within the predicate should be inaccessible for further A- or A'-movement. For Nisga'a and Gitksan, (23) demonstrates that it is indeed impossible to extract the incorporated object in a VOS construction: (23b) shows that the only possible way to extract this element is as a fully-licensed transitive object; other extraction options in (23c-f) fail.

- (23) a. Yo'oks-no'ohlt Michael.
yo'oks-no'ohl=t Michael
wash-dish=PN Michael
'Michael washed the dishes.'
- b. Guhl yo'oksis Henry?
gu=hl yo'oks-i=t=s Henry
what=CN wash-TR-3.II=PN Henry
'What did Henry wash?' (*O extraction*)
- c. *Guhl yo'oksitt Henry? (*S or Posr extraction*)
- d. *Gu wil yo'oks Henry? (*Oblique extraction 1*)
- e. *Guhl yo'oks Henry? (*Oblique extraction 2*)
- f. *Yo'oks-gut Henry? (*WH in situ*) Gitksan (VG)

In contrast, (24) illustrates that indirect objects and prepositional phrases may be successfully extracted. Such elements consequently cannot be underlyingly predicate-internal.

- (24) a. Naa wil ksaxgi'nama'as Peter?
naa wil ksax-gi'nam-a'a-t=s Peter
who COMP only-give-DETR-3.II=PN Peter
'Who did Peter give (a gift) to?' Nisga'a (Tarpent 1987, 275)

- b. Nda wil jogan?
 nda wil jok̄-n
 where COMP reside-2SG.II
 ‘Where do you live?’

Nisga’a (Tarpent 1987, 279)

In addition, if a phrase has vacated the predicate via syntactic movement, then we expect that it itself has raised to a specifier position and is now subject to constraints on sub-extraction: it should be an island. We therefore predict that extraction from CP complements should be impossible, since those CP complements are either syntactically embedded within the raised predicate and are only linearized outside, or else they have vacated the predicate by movement to a specifier position. Either option should render them islands for sub-extraction. Yet we find in (25) that CPs in IT clearly allow sub-extraction, with each clause showing morphological evidence of successive A'-movement (Davis & Brown 2011; Forbes to appear).

- (25) 'Nitgat Mark anhees Lisa ga'as Henry ant liluxwshl
 'nit=gat M an-he-t=s L [ga'a-t=s H [an=t liluxws-t=hl
 3.III=REPORT M AX-say-3.II=PN L [see-3.II=PN H [AX=3.I steal-3.II=CN
 biket.
 bike-t]]
 bike-3.II]]
 ‘It was MARK that Lisa said Henry saw steal his bike.’

Gitksan

The head-movement approach, whereby V° moves over all arguments and phrases, provides the more natural account of these facts. While the incorporated noun may be inaccessible for extraction, all other arguments and phrases remain in their base positions. These in-situ arguments are easily accessible for subsequent movement operations, and their contents accessible for sub-extraction. It is much more difficult to model these basic facts under the predicate-movement approach, which requires most phrases to undergo some kind of movement.

3.3 Summary

This section can be condensed to three main points. First, IT noun-incorporation is of a non-minimal NP, rather than an minimal N° ; it is best understood as pseudo-incorporation. Second,

verbal modifiers and non-phrasal adjuncts always precede the predicate, consistent with the predictions of a predicate-raising approach where modifiers raise with the predicate, and contra the predictions of a head-raising approach where they should be stranded following the predicate. Finally, the extraction and sub-extraction potential of all DP, PP, and CP phrases can only be achieved in an analysis where these phrases remain in their base positions: they do not undergo any kind of movement whatsoever, whether from the vP or along with it.

All of these properties are captured under Massam's (2020) predicate-raising analysis, whereby most phrases—including DP objects—are merged outside of the predicate vP . Verbal heads, low adverbs, and pseudo-incorporated NP objects are the only elements merged within the predicate, and all raise together to the specifier of a higher functional projection above the predicate-external arguments.

4. Predicate-raising for Interior Tsimshianic VSO and VOS

In this section, I implement Massam's (2020) predicate-raising analysis with specific reference to basic VSO clauses and incorporated VOS constructions in Interior Tsimshianic (IT; Nisga'a and Gitksan). I demonstrate that this analysis, proposed for morphologically-analytic Niuean, successfully derives the order of morphemes in the much more complex Tsimshianic predicate with only minor modification. The morphological complexity of the Tsimshianic predicate furthermore provides interesting cues to the composition of pseudo-incorporation, antipassives, and passives, including how these structures combine.

4.1 Predicate-external objects and VSO

Under Massam's (2020) proposed structure, the predicate morphemes and argument phrases are not put together in a single domain, interspersed with one another as heads and specifiers, but rather are organized in two different domains. In the lower thematic domain (vP or PredP), all heads and morphology relate to the construction of the predicate. Consider the derivation of the transitive sentence in (26); the construction of the predicate is illustrated in (27). The entire predicate is generated within vP , including any low adverbial modifiers or preverbs that might be present, and

any stacked V or *v* heads. Heads like the main verb, causatives, and applicatives introduce theta roles, but not arguments. If the main verb is an incorporating verb, as the inherently causative main verb *k'ohl* ‘cut, gut (fish)’ is here, it takes an implicit object *pro* of type NP as its complement.

- (26) *k'ohl-i-'y=hl* *hoon*
 gut-TR-1SG.II=CN fish
 ‘I gutted a/the fish.’

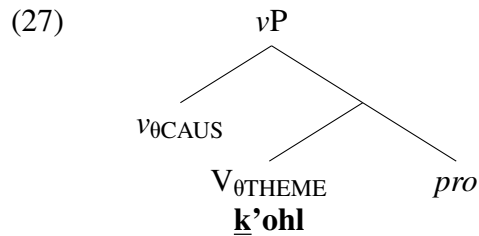

Once the predicate is constructed in its entirety, phrasal arguments may be merged *vP*-externally as illustrated in (28); they do so in hierarchical fashion in accordance with the order that theta roles were introduced (‘high argument merge’; [Massam 2020](#)). Depending on the lexical item and the language, the complement *pro* must be coindexed with a full DP object merged above *vP*, or may potentially saturate the theme theta role and serve as an implicit object. Formal Case-licensing takes place amongst the *vP*-external. The heads X and Y which introduce these arguments may be associated with inflection or viewpoint aspect. In Tsimshianic, I suggest one of these heads (e.g. X) is the home of the transitive marker required in independent-order clauses (following [Forbes 2018, 2019b](#)).

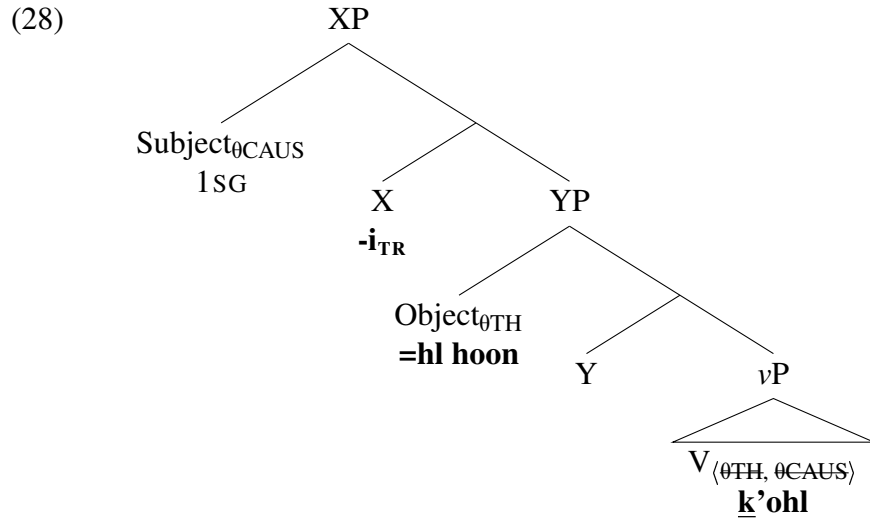

Finally, after all arguments have been introduced, a last inflectional head (Infl) is merged. The predicate phrase moves to its specifier, as illustrated in (29), producing VSO order. I propose that in IT, this head Infl is the locus of suffixal agreement, and the endpoint of some rollup of inflectional heads including the transitive marker (Forbes 2018).

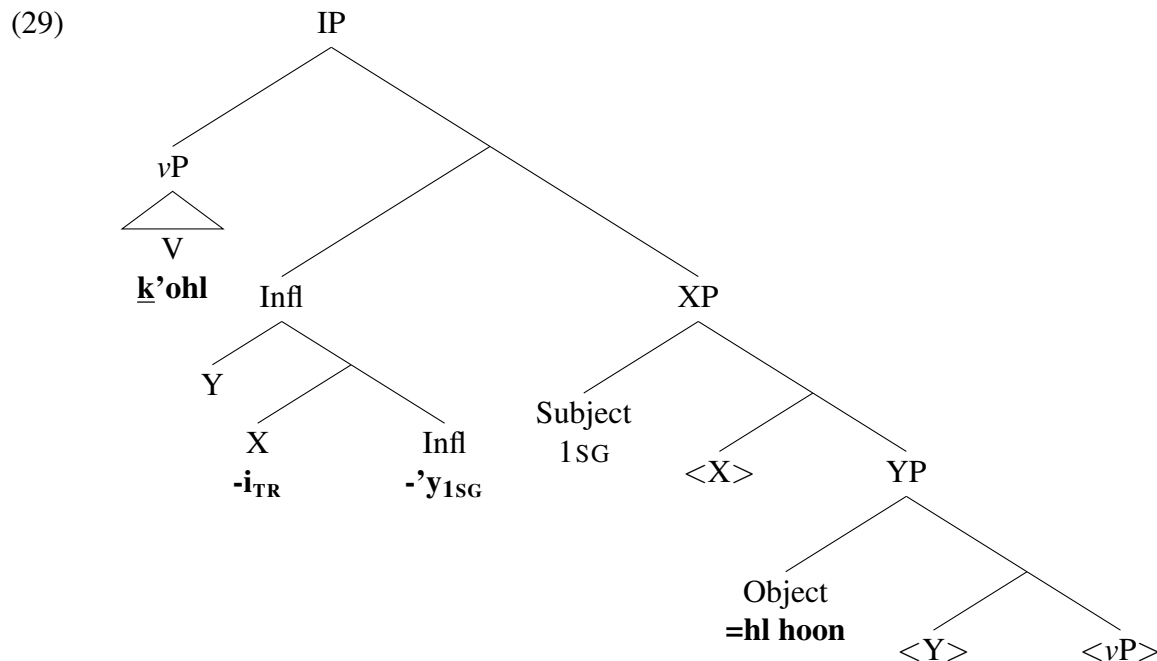

In the resulting structure, there are no elements remaining leftward of the verb word (vP+Infl) except phrasal arguments merged in the inflectional domain. All modifying adverbs are contained

within *v*P and raised; additional T- and C-level material such as temporal adverbs or discourse markers may either precede or follow this entire IP constituent. Furthermore, since all arguments remain in their base positions, all are accessible for extraction or sub-extraction, as is attested in the IT data.

We expect that indirect objects and CP arguments, as well as adjunct phrases like locations and instruments, can also be introduced outside the predicate. While the merge position of adjuncts is not especially important, the argument phrases are crucially merged in a hierarchical order that maps to the order of theta roles introduced with the predicate, such that the innermost theta role is filled with the lowest argument (Massam 2020 for further discussion of this mapping operation). The hierarchical nature of argument merge in the inflectional domain crucially differentiates this approach from a non-configurational analysis in line with the Pronominal Argument Hypothesis. Under the PAH, arguments are merged as high adjuncts; here they are merged hierarchically, and thus typical *c*-command relations and ordering restrictions are expected as in other configurational approaches. The two approaches are only similar in that DP arguments are not merged at the point of theta-role assignment, requiring a process of semantic mapping to take place between the set of available thematic roles and available DP, PP, or CP arguments.¹¹

4.2 *Predicate-internal objects and incorporation-VOS*

Under this predicate-raising analysis, pseudo-incorporation occurs when an overt NP is merged as the verbal complement rather *pro*_{NP}: an explicit object, rather than an implicit object, but with a similar generic or canonical interpretation. I illustrate here with the incorporation construction in (30). The predicate in (31) is constructed in much the same way as in the earlier transitive structure, but this time with an overt NP in complement position which immediately saturates the theme theta role.¹²

¹¹As Massam (2020) discusses, multiple authors have independently argued that arguments are not merged directly at the point of theta-role assignment. For external arguments: see e.g. Kratzer (1996); Harley (2013); and Forbes (2019b) for Gitksan specifically. For internal arguments: see e.g. Borer (2005); Pytkäinen (2008); Travis (2010); Cuervo (2014); Ramchand (2016).

¹²In some languages, the incorporated NP may not immediately saturate the theta role; see e.g. Chung & Ladusaw (2004) for discussion and implementation of this contrast.

- (30) k'ohl-hoon 'nii'y
 gut-fish 1SG.III
 'I gutted fish.'

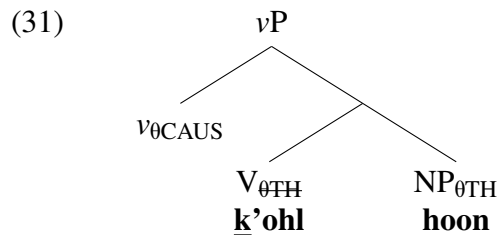

The remaining theta role is saturated through merge of a subject causer outside the predicate. Again, when Infl is merged the *vP* passes over the arguments to move to spec-Infl, as illustrated in (32). The resulting structure has VOS order.

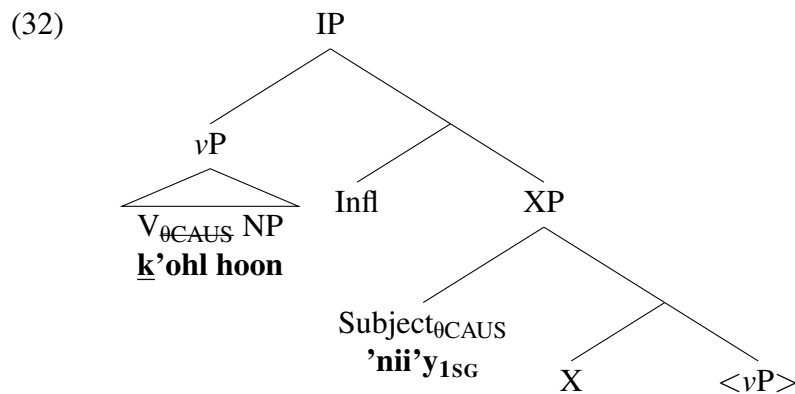

In the independent clause structure represented in (32), there is no agreement or transitive marking on the heads Infl or X because the PNI clause is intransitive. However, we can also consider incorporation in dependent-order clauses like the imperative in (33), which have intransitive suffixal agreement on the right edge of the incorporated object.

- (33) yats lakw-a sginist-n
 chop firewood-ATTR pine-2SG.II
 '(Go) chop pine wood!'

First, the NP object is merged as the complement of V within the predicate, as in (34). Then, after

the subject is merged, Infl agrees with the subject and is realized as the suffixal agreement marker. It attracts the predicate *vP* to its specifier, and suffixes to the right edge of the NP object, as in (35).

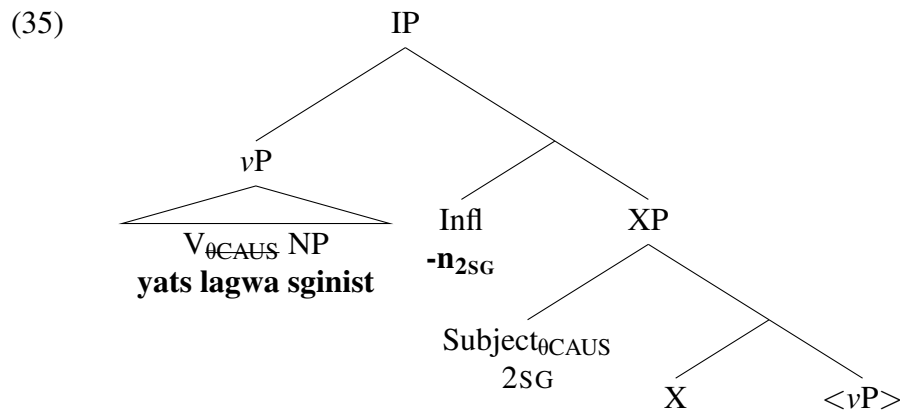
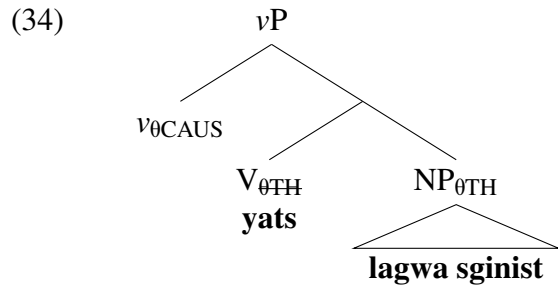

Overall, this analysis allows for the modeling of IT morpheme and word order, and also appropriately models the division between incorporated NP objects (which cannot be extracted) from all other phrases (which allow both extraction and sub-extraction). Incorporated objects are the only phrases merged inside the *vP*, and are also pied-pied with it. The phrasal nature of the predicate, inclusive of both incorporated object and preverbal modifiers, furthermore straightforwardly allows these elements to be captured as a single prosodic unit, capped on the right edge with suffixal inflection.

5. Incorporation versus adjacency

I here devote some additional attention to the distinction between the VOS order in noun incorporation, and the VOS order conditioned by a participant object. I argue that the adjacency-based approach to PNI forwarded by Clemens (2014, 2019) is specifically unable to model PNI in Inte-

rior Tsimshianic. Objects which are simply verb-adjacent, like participant objects in Nisga'a, are amenable to either prosodic or syntactic analyses of object movement, while incorporated objects are not.

5.1 *Against a prosodic analysis for PNI*

Clemens's (2019) prosodic reordering analysis states that the verb moves above the subject through successive head movement, and the subject and object arguments remain in their base positions, resulting in a base VSO order. After syntax, a prosodic constraint (ARGUMENT- Φ) applies to the phase, demanding that an object be pronounced adjacent to its selecting head, the verb. Only NP objects, part of the same phase as the verb, are ultimately subject to this condition.

We have already discussed some reasons why a *vP*-raising analysis provides a better model for IT clause structure than a *V*^o-raising one. The most relevant one in the face of Clemens's proposal is that adverbs in IT precede the verb, rather than being stranded leftward. This cannot be accomplished under head-movement, which would predict that such adverbs should be stranded low. An additional piece of counterevidence arises simply from the morphological structure of PNI in IT: the incorporated object does not just appear *adjacent* to the verb word, but rather *inside* it, nested inside inflectional morphology, as illustrated in (36).

- (36) Getxwhl loo'y ahl dim t'aahl miiyehli'y.
 getxw=hl loo-'y a=hl dim t'aahl-**miiyehl**-'y
 hard=CN OBL-1 SG.II PREP=CN PROSP pick-blueberries-1 SG.II
 'It's hard for me to pick blueberries.' *Gitksan* (from (7))

Orthographic considerations aside, the distribution of second-position clitics clearly demonstrates that the entire verb-object complex patterns as a single prosodic word in the calculation of clitic placement (37). A verb's inflectional suffixes also pattern as part of the same prosodic word as the verb, as shown in (38). In both cases, this contrasts with the behavior of cliticized connectives associated with the following noun, which attach only after the second-position clitic.

- (37) a. Yets legw**ima**'at Lisa.
 yets-lekw=ima'a=t Lisa
 chop-fuel=EPIS=PN Lisa
 'Lisa might have chopped some wood.'
- b. *Yej**ima**'a lekwt Lisa. *Gitksan*
- (38) Hlimooyid**ima**'as Michael 'nii'y.
 hlimoo-i-t=ima'a=s Michael 'nii'y
 help-TR-3.II=EPIS=PN Michael 1SG.III
 'Michael might have helped me.' *Gitksan*

This demonstrates that if the incorporated NP is moved on the basis of a prosodic condition, its landing site is therefore unintuitively inside a prosodic word.¹³

The morphologically fusional, rather than analytic, nature of IT pseudo-incorporation makes clear that at least this instance of incorporation cannot be derived through reference to simple verb-adjacency. However, the more general concept of syntax-prosody mismatch and prosodic rearrangement is still broadly necessary to account for many aspects of IT morphology. I argue that the transitive VOS construction attested in Nisga'a is precisely one such case, producing a VSO/VOS alternation in a loosely similar fashion to Clemens's adjacency-oriented analysis of PNI in Austronesian.

5.2 Participant-conditioned VOS

The Nisga'a participant-based VOS construction is quite distinct from the PNI construction we have focused on to this point. While third-person pronominal objects appear in VSO order, as in (39a), first- and second-person pronominal objects appear in VOS order, as in (39b).¹⁴ The fact that only participant pronouns appear in VOS order, while third-person pronouns do not, demonstrates

¹³The inflectional suffixes themselves pose a further problem for the prosodic-PNI analysis: if the verb has raised above the subject through head movement, then its inflectional suffixes would likely have been collected through rollup movement. Then the attested position of the incorporated NP is not only inside a prosodic word, but also a complex head, something which no theory of syntax-prosody mapping would easily allow.

¹⁴Note that the relative order of subject and object can only be concretely identified when the subject is an overt DP (as discussed in section 2). If the subject is a pronoun then its only surface realization is the verbal agreement suffix, and word order is simply V-agr O. It remains an open question whether the word order alternation is conditioned by the participant status of the object alone, or more specifically by a participant object under a third-person subject (as suggested by the label 'word order inverse' given for similar patterns by Givón 1994).

that this alternation cannot be attributed to the pronominal character or prosodic ‘lightness’ of the object.

- (39) a. Hlimoomis Ann ’nit.
 hlimoom-i-t=s Ann ’nit
 help-TR-3.II=PN Ann 3.III
 ‘Ann helped her.’
- b. Hlimoomit ’nii’y t Ann.
 hlimoom-i-t ’nii’y t Ann
 help-TR-3.II 1 SG.III PN Ann
 ‘Ann helped me.’

Nisga’a (Jelinek 1986, 9)

While incorporated objects may be nested within verbal suffixes including agreement, the object in a participant-VOS construction always appears following all verbal suffixes: it is simply *verb-adjacent*, rather than incorporated into the verb word. The participant object also acts as a syntactic direct object. A participant-VOS clause is transitive, exhibiting transitive markers on the verb stem and ergative agreement, as in (40a). An incorporation-VOS clause, by contrast, is intransitive, and exhibits neither of these morphemes in independent clauses, demonstrated in (40b).

- (40) a. Hlimoomit ’nii’y t Ann.
 hlimoom-i-t ’nii’y t Ann
 help-TR-3.II 1 SG.III PN Ann
 ‘Ann helped me.’
- b. K’ohlhoon ’nii’y.
 k’ohl-hoon ’nii’y
 gut-fish 1 SG.III
 ‘I gutted fish.’

Nisga’a (from (39b))

Nisga’a (from (6b))

In addition, participant objects can be successfully extracted in the manner expected of transitive objects, as illustrated in (41).

- (41) 'Nii'yhl gibayit.
 'nii'y=hl giba-i-t
 1SG.III=CN wait.for-TR-3.II
 'She was waiting for ME.' *Nisga'a* (Tarpent 1987:262)

All of these properties contrast starkly with those of incorporated objects. Incorporated objects are morphologically and syntactically part of the predicate, while participant objects are predicate-external. Incorporated objects are indefinite, non-specific, and Caseless, while participant objects are referential and participate fully in transitive Case-licensing and the calculation of agreement. Framed in terms of this paper's proposal for IT clause structure: the incorporated object is a non-argument base-generated ν P-internally, within the syntactic and prosodic domain to which the agreement suffixes in Infl attach. Participant objects are ν P-external true arguments, and move in such a way that the agreement suffixes do not fuse to them.

The result is something that, at least on the surface, can be conceptualized as an atypical 'licensing' condition, in the sense that it affects the realization of certain arguments, but only in terms of their linear order, not syntactic Case or any other identifiable syntactic/semantic property. However, this construction does not at all resemble prior analyses of 'licensing by adjacency', which typically handle PNI constructions with caseless objects; in these analyses, verb-adjacency is taken as a means to or consequence of sidestepping the case requirement (Baker 2014; Clemens 2014, 2019; Levin 2015; Erlewine et al. 2018; van Urk 2020). As the *Nisga'a* participant object seems to have already fully participated in transitive case/agreement-licensing, the operation that moves it to a verb-adjacent position cannot be understood as one that either obviates or replaces syntactic licensing. Participant reordering to a verb-adjacent position, if it is indeed a kind of licensing, seems to be necessary in addition to, or entirely separately from, standard Case-based licensing.

The question is then, how does the object move? I suggest that we simply cannot tell. Consider a syntactic analysis: Bruening's (2001, 2005) account of inverse constructions in Pasamaquoddy (Algonquian) presents a structure whereby participant objects move to a position c-commanding third person subjects. We can model this here as a higher licensing projection PersonP in (42), above the argument-merging phrases.

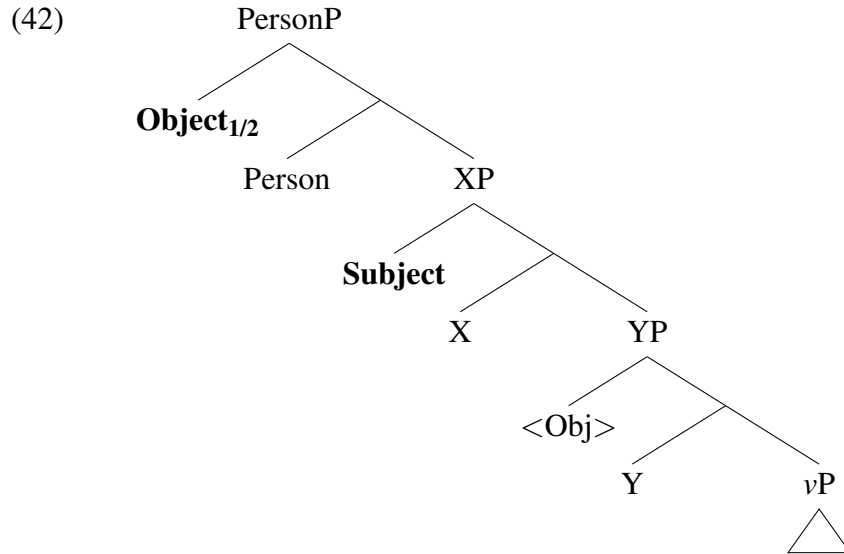

There are several potential diagnostics which could demonstrably indicate that such movement has taken place.¹⁵ The object in this position still follows the verb and verbal agreement. We might predict that from this higher position, it would be a more-local candidate for agreement. However, as we have seen, agreement in these constructions remains with the ergative subject as usual.¹⁶ We might also suppose that the higher position of the object in these constructions should affect the A'-extraction potential of either subject or object; but again, we see that both arguments are easily extracted in precisely the manner expected of a typical transitive construction.

- (43) a. Naa ant giban?
 naa an=t giba-n
 who AX=3.I wait.for-2SG.II
 'Who (was it who) waited for you?'

¹⁵Binding is not one of them, not least because one of the two arguments is necessarily a participant pronoun. Binding tests are also difficult to apply in Interior Tsimshianic (Hunt 1993; Forbes 2019a).

¹⁶By contrast, these same constructions in related Coast Tsimshian *do* show changes to the behavior of agreement (Forbes 2018; Brown et al. 2020). There is an optional instance of special agreement with participant objects in Gitksan, discussed by Forbes (2018, to appearb), though of course Gitksan does not exhibit the marked VOS order. I have not been able to glean from the Nisga'a literature whether identical agreement facts hold there; however, if it does, this would be some of the only evidence to consider a special syntactic status for participants. The Gitksan alternation in question only takes place in dependent clauses where the linear order of pronouns is indeterminable, and is overridden by a third-plural subject, so the extent of participant objects' special status is difficult to fully determine. Forbes (2018) presents an analysis of the agreement facts that does not adopt object raising.

- b. 'Nii'yhl gibayit.
 'nii'y=hl giba-i-t
 1SG.III=CN wait.for-TR-3.II
 'She was waiting for ME.' *Nisga'a* (Tarpent 1987, 261-2)

Again, while the absence of evidence cannot be taken as proof of the absence of syntactic movement, it remains the case that the only evidence for object movement in *Nisga'a* is in the surface word order. There are no additional supporting effects or alternations to disambiguate whether object movement is the result of a deeper syntactic or more surface-oriented linear operation. We are essentially left with 'Schrödinger's analysis': two possibilities, and no clear way to decide between them. The fact that the VSO-VOS alternation lacks any identifiable syntactic or semantic consequences could be taken as evidence that it is post-syntactic: the linear configuration of a Participant followed by Third Person is dispreferred, and some linear reordering operation at PF rearranges them. Alternately, the object may have moved to some low topic position in the syntax that does not change its effective relation to the subject for the purposes of agreement or extraction (e.g. Zubizarreta & Pancheva 2017).

It is not particularly satisfying to be left with an open analysis, but such a situation is precisely one where we might expect variation to emerge over time. Consider the realization of the participant object in cognate constructions from all four Tsimshianic languages in (44).

- (44) a. Hlimooyis Mary 'nuu'm.
 hlimoo-i-t=s Mary 'nuu'm
 help-TR-3.II=PN Mary 1PL.III
 'Mary helped us.' *Gitksan* (Rigsby 1986, 264)
- b. Ts'ilyawit 'nuu'm t Mary.
 ts'ilyaxw-i-t 'nuu'm t Mary
 visit-TR-3.II 1PL.III PN Mary
 'Mary came to visit us.' *Nisga'a* (Tarpent 1987, 339)
- c. T waayi'nu haasit.
 t 'waa='nu=a haas-it
 3.I find=1SG=CN dog-DEM
 'The dog found me.' *Coast Tsim.* (Mulder 1994, 58)

- d. Dm limoomini t Sam.
 t=dm limoom=**n**=i t Sam
 3.I=PROSP help=2SG=CN PN Sam
 ‘Sam will help you.’

Southern Tsim. (Tarpent 2012, 5)

Gitksan (Interior) in (44a) has lost the VOS construction altogether, with participant pronouns appearing in VSO order just as full DPs do. It has no object movement of any kind, at syntax or PF. In Coast Tsimshian and Southern Tsimshian (Maritime) in (44c-d), all postverbal participant pronouns are reduced elements which cliticize onto the verb word, regardless of whether they are subjects or objects. Participant-VOS constructions also exhibit a marked preverbal agreement pattern, likely indicating a deeper syntactic difference (Forbes 2018; Brown et al. 2020).

That is, both of Nisga’a’s neighbors have resolved the ‘Schrödinger’s analysis’ problem by erasing it. Perhaps Gitksan leant towards the ‘shallower’ PF analysis, and then subsequently lost the vacuous movement, while Coast Tsimshian leant toward the syntactic analysis, and developed additional cues for it by way of preverbal agreement.¹⁷ Only in Nisga’a does the intermediate position remain, involving superficial pronoun movement, but no reduction, cliticization, or impact on other clausal properties like transitivity or agreement.

6. Internal structure of the IT incorporating predicate

Having illustrated the substantial benefits of a predicate-raising analysis with high argument merge for modeling the syntactic and word-order properties of Interior Tsimshianic, in this section I briefly consider the internal structure of the predicate. The simple cases of PNI discussed thus far can be modeled straightforwardly under the proposed predicate-raising analysis, but IT also offers an array of additional verbal morphology that allows us to probe the structure of the predicate in greater detail. I leave an exhaustive examination of argument structural alternations in IT for future work, here focusing on cases of *PNI* involving causativization, passivization, and antipassivization, with specific reference to how argument structural morphology linearizes around the incorporated NP object. This provides insight into not only the internal structure of the IT predicate, but also

¹⁷Of course we will never know what the oldest pattern was; whether it was one of the attested synchronic options, or another entirely. The oldest recorded Tsimshianic data is from Boas (1902), which shows the same patterns.

the semantic and syntactic nature of complex incorporation constructions more broadly.

6.1 Causatives and passives

The IT languages have three distinct morphological causatives which syntactically and semantically compose with the verb at different levels (Belvin 1997). The indirect causative *gun~gwin* can be combined with any predicate that has an existing causer, including intransitive PNI predicates, to form transitives as in (45). Here, the causative preverb *gun* appears at the left edge of the predicate, and transitive inflection and agreement appears on the right edge of the incorporated noun (as discussed in section 4.2).

- (45) **Gun** yets legwis Baba 'nii'y.
gun yets -lekw-i-t=s baba 'nii'y
CAUS chop wood-TR-3.II=2SG.II dad 1SG.III
'My dad made me chop firewood.' Gitksan

These transitives can then subsequently be passivized, as illustrated in (47). Incorporation constructions can also be marked with the passive to denote a reflexive use, as in (47). Passive/reflexive and detransitivizing morphology in IT is suffixal, and in both cases, like the causative, the morphemes affix to the incorporated noun rather than the verb.

- (46) Gun yets legwa'a/lekws 'nii'y.
gun yets -lekw(-a'a/-xw) 'nii'y
CAUS chop wood(-DETR/-PASS) 1SG.III
'I was made to chop firewood.' Gitksan

- (47) Yukwhl dim yo'oks'weentgwi'y.
yukw=hl dim yo'oks-'ween-kw-'y
PROG=CN PROSP wash-teeth-PASS-1SG.II
'I am about to brush my teeth.' Nisga'a (Tarpent 1987, 205)

Unlike the transitive marker in (45), these detransitivizing morphemes are not so easily analyzed as *inflectional*. The transitive marker's appearance is conditional on the clause type and is never used as part of the isolated citation form of a verb, while detransitivizing suffixes appear

consistently regardless of clausal order and are commonly used in isolated citation forms. Indeed, such detransitivizers feed derivation in deverbal nouns such as *anooya'a* ‘a tool (something that is used)’, while the transitive marker does not. I consequently propose that the passive and detransitive markers in (47) should be analyzed as suffixes internal to the *vP*, not as *vP*-external inflection like the transitive vowel or agreement. It is then necessary to consider how the passive/detransitive suffixes attach to the incorporated object rather than the verbal head.

The causativizing and passivizing operations corresponding to these morphemes impact the causer *moreso* than the incorporated theme. From a scope perspective, it is therefore within the realm of expectation that the morphemes might appear circumfixally around the VP constituent within which the theme is already embedded. However, the fact that V and its complement NP serve jointly as the host for these suffixes makes clear that suffixation is not achieved via roll-up movement: the VP constituent, a phrase, cannot have undergone head-movement. Suffixation is also not achieved via affix-lowering or merger under adjacency onto the immediately c-commanded head, as it would then be expected to only target the verb, not the VP.

More broadly, we can draw a relevant generalization about the structure of the IT *vP*: the verb root has prefixes and preverbs on one side, and argument-structural suffixes on the other, but both sides of the verb broadly respect scope, producing a nesting effect illustrated in (48). Prefixes and preverbal elements are ordered outward-inward, while suffixal elements are ordered inward-outward.

(48) [3 [2 [1 [V] 1] 2] 3] → 3-2-1-V-1-2-3

Consider the following illustrative examples: in (49), the result-state provided by the preverb-verb pair *suu k'eek* ‘away-run’ is nested within the causative *-in* and subject-oriented preverb *si'ix* ‘try’. In (50), we see the outward order of suffixes demonstrated with the passive suffix appearing outside the causative.

(49) Neehoxdii si'ix suu k'eegani'm.
 nee=hox=dii=t si'ix suu k'eek-in-'m
 NEG=again=FOC=3.I try away flee-CAUS-1PL.II
 'She doesn't keep trying to chase us away.' Gitksan

(50) Huxwdii jiksintxwhl ksuu'w.
 huxw=dii jiks-**in-xw**-t=hl ksuu'w
 also=FOC wet-CAUS-NACT-3.II=CN hemlock.bark
 'The ksuu'w (hemlock inner bark) is also moistened.' Gitksan (from (18))

While a scope-congruent order for suffixes is commonly analyzed as the result of head-movement, a scope-congruent order for prefixes and right-side modifiers conversely seems to demonstrate that the verb does not move at all, as the lowest modifiers would then be stranded toward the left edge.

I here suggest two possibilities to linearize the IT predicate, capturing nested orders above as well as suffixal attachment outside the incorporated NP object. The first respects the fixed head-initial order broadly expected of V1 languages and required in an Antisymmetric approach (Kayne 1994). Functional heads within the predicate must successively raise their complements to specifier position. This is illustrated in (51) with a sequence of functional heads [X, Y, ...] and adjoined modifiers [A, B, ...] over the VP.

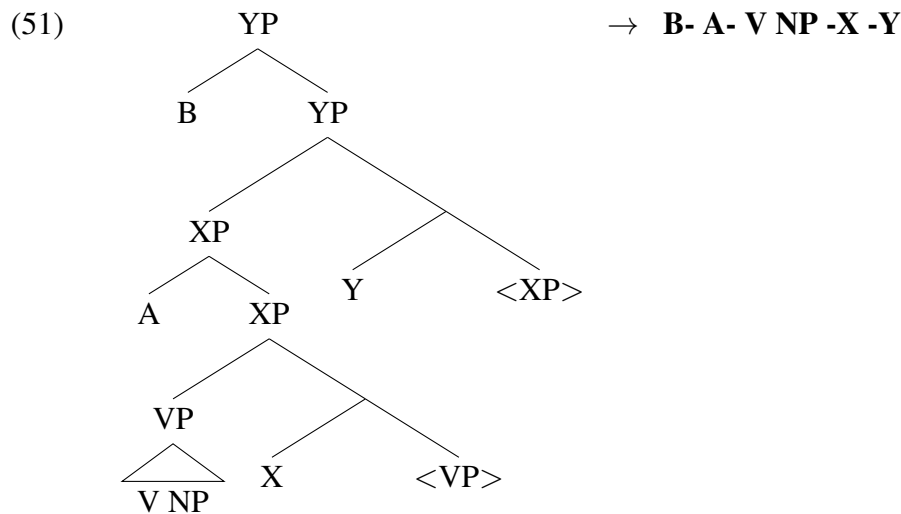

The successively nested structure is unusual, requiring multiple instances of complement-to-specifier movement. Such movement might be considered undesirable for a few reasons: certainly from

a processing standpoint, but perhaps also under some formulations of anti-locality. However, the sequence of syntactic islands produced by this structure is not an obstacle to the rest of the derivation, given that nothing within the predicate is ever extracted (recall that all arguments are merged predicate-externally).

The second option sacrifices strict-head initial order for a more straightforward structure, illustrated in (52).

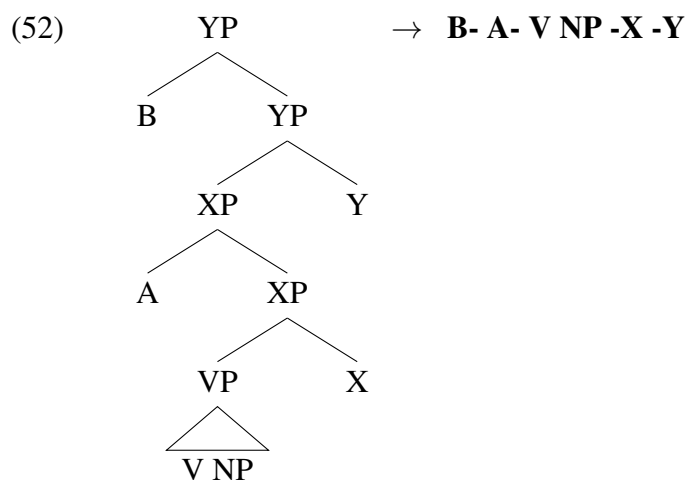

Under this analysis, the majority of the IT predicate is *head-final*, excepting only the verbal root and its complement; functional structure outside of the predicate would also be head-initial. IT does in some small ways behave counter to the expectation of strictly head-initial languages: modifiers precede heads and there are a number of sentence-final particles, including the question marker. However, this structure wherein a head-initial VP is topped by head-final functional projections directly contradicts the Final-Over-Final constraint (Holmberg 2000; Biberauer et al. 2009, 2014). This proposed universal linguistic constraint states that head-final projections only appear over other head-final projections; head-final projections over head-initial projections are banned.

This paper aims not to decide between these two possibilities, but merely to present the conundrum. Depending on one's attachments to the aforementioned formal constraints on syntactic structures, one or the other option might be more attractive. Alternately, the problem itself may demonstrate that syntax and linearization within the predicate differs in some ways from the same

operations outside. The general syntactic approach proposed by Massam (2020) and implemented further in this paper—where predicates are composed in a lower domain and arguments merge high—potentially allows for such a division. The predicate-internal domain, while here still syntactic, loosely maps to what in many grammatical models would be the domain of the lexicon.

6.2 Antipassives

Antipassives and incorporation have many similarities; Polinsky (2017) states that “incorporation... can instantiate the antipassive”. The view from IT, within the syntactic model adopted here, provides something of an inverted perspective on this claim: the IT antipassive seems to produce a derived incorporation construction.

The antipassive in IT commonly occurs alongside incorporation (Tarpent 1987, 698). Indeed, certain inherently-transitive verbs like *gup* ‘eat, feed on’ or *jap* ‘make, build’ do not allow incorporation with a bare verb form; rather, incorporation with these roots is only possible with an overtly antipassive form of the verb, illustrated in (53).¹⁸

- (53) Needii gubasxum smaxt.
 nee=dii gup-asxw-m -smax-t
 NEG=FOC eat-ANTIP-ATTR -meat-3.II
 ‘He never eats meat.’ Gitksan

¹⁸Given the category-flexible nature of predicates in Tsimshianic, one might question whether the predicate *gubasxum smax* in (53) is a verb exhibiting incorporation (e.g. ‘He doesn’t meat-eat’) or a compounded nominal predicate (e.g. ‘He is not a meat-eater’). The following example demonstrates that this phrase cannot be used in argument position without being explicitly relativized, clearly indicating its verbal status (Forbes 2012; Davis et al. 2014).

- (i) Sga’wayi’yhl gubasxum smeyit/*smex.
 sga’wa-i-’y=hl gup-asxw-m smex-*(it)
 meet-TR-1 SG.II=CN eat-ANTIP-ATTR meat-*(SX)
 ‘I met someone who eats meat, a meat-eater.’ Gitksan

It should be noted that compound nouns can and do take exactly the same form, but are typically interpreted as referring to the object, not the actor. This is illustrated in (ii).

- (ii) Nidiit giphl jakw’isgum gaxt.
 ni=dii=t gip-t=hl jakw-’iskw-m gax-t
 NEG=FOC=3.I eat-3.II=CN kill-ANTIP-ATTR rabbit-3.II
 ‘He did not eat the rabbit he had killed [his killed-rabbit, game-rabbit].’ Nisga’a (Tarpent 1987, 695)

In addition to disallowing bare V-N incorporation, these roots are also strictly transitive and cannot be used as unergative intransitives. To suppress the object, antipassivization is obligatory.

I propose that this class of verbs does not take a direct NP complement; they introduce an internal theta role but do not subcategorize for either an implicit *pro* or an explicit incorporated NP. In order to merge such an NP, the verb must first compose with the antipassive, which has the effect of licensing the *v*P-internal NP. Once the antipassive has been introduced, the NP object may be merged, resulting in an antipassive-PNI construction like (53). Alternately it may take an implicit *pro*_{NP} object, saturating the inner theta role, which may later be interpreted as coreferential with some predicate-external oblique. Either way, the antipassive morpheme and newly-licensed incorporated NP compose with the verb to produce a predicate with the generic, indefinite, or atelic interpretation characteristic of both antipassive and PNI constructions.

We see from (53) that unlike the passive marker, the antipassive intervenes between the verbal root and the incorporated nominal. This might be interpreted as a matter of scope: unlike passives and causatives, the antipassive mediates between the verb and the object. Perhaps it then appears structurally lower, even composing with the verb root directly. However, the IT antipassive (N: *-skw*, G: *-sxw*) does not always appear immediately adjacent to the verb. On inchoative or nominal roots, it instead appears outside the causative, as in (54), and it is always the final element in the verbal stem.

- (54) a. *ba-'an-skw*
run-CAUS-ANTIP
'drive (a car)'
- b. *si-wilaa-'yin-skw*
CAUS-know-CAUS-ANTIP
'teach'
- c. *k'udats'-a'an-skw*
coat-CAUS-ANTIP
'put the coat on the bride (in traditional wedding)' *Nisga'a*, (Tarpent 1987, 696)

This suggests that the antipassive has relatively high attachment, and yet intervenes between

the verb and the NP theme. Unlike the passive, then, which appears in a functional layer over the predicate and outside the incorporated NP, I suggest that the antipassive requires a different relation between predicate and NP, and perhaps a different type of semantic composition altogether. Based on the linear order of the IT construction, the antipassive may take the predicate and NP element as arguments as in (55), relating them and contributing its own semantic content in the process.¹⁹

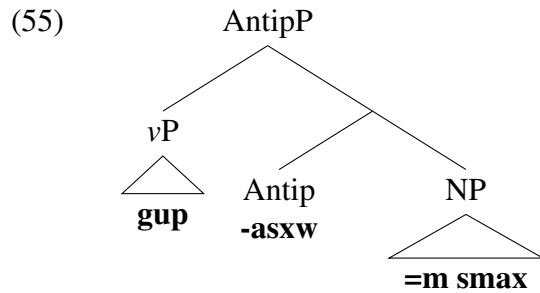

I leave the precise means of both language-specific and crosslinguistic antipassive composition for further work. The IT data discussed here has provided a novel understanding of the relation between pseudo-noun-incorporation and antipassivization: both leverage a predicate-internal NP to produce generic and atelic readings, but one involves direct V-NP composition and the other a more complex derivation. The IT data furthermore clearly demonstrates a major difference between the passive and antipassive ‘voices’ in terms of their composition with the predicate and relation to the object nominal.

7. Conclusion

This paper has provided an analysis of verb-initial orders in the Interior Tsimshianic languages, which exhibit prefixing and suffixing morphology alongside two distinct VSO-VOS alternations. I have demonstrated that the first VOS construction can be understood as NP pseudo-incorporation, and argued that the second VOS construction is the consequence of a largely vacuous movement operation on participant objects after they have been licensed; VSO order is otherwise the default.

¹⁹Potentially of relevance to this discussion is the fact that the IT antipassive construction is extremely category-flexible. As a verb, it is realized either as an intransitive atelic verb or a PNI construction (with *pro* vs overt NP, respectively); as a noun, it is realized either as a zero-nominalization or a compound nominal (with *pro* vs overt NP, respectively).

The resulting picture of IT is of a set of languages with three possible surface object positions: pre-subject, post-subject, and incorporated.

I have demonstrated that the morphological and syntactic properties of these languages strongly support a predicate-raising approach following [Massam \(2020\)](#), whereby the complex predicate is constructed in its entirety before any true arguments are merged. Once all relevant arguments have been merged, the predicate raises over them. The only ‘argument’ which may appear as part of the predicate constituent is a direct NP complement of the verb: the caseless, pseudo-incorporated object. This accounts for the clean split in IT between the preverbal position of predicate-related material versus the postverbal position of argument-related material, and for the linear and syntactic properties of incorporated versus non-incorporated phrases. The analysis provides two potential base positions for objects: predicate-internal versus -external, and the separate predicate domain allows us to more easily construct verbal morphology around the internal object. Such morphological incorporation is not accommodated under previous accounts of PNI treating only the caseless object’s linear order with respect to the verb. The successful application of this analysis to a second, unrelated group of languages, demonstrates its merit as an option for deriving verb-initial order.

Beyond the issue of word order, the present study also highlights the relevance of pseudo-incorporation for our understanding of the structure of complex predicates. The location of IT argument-structural morphology around the incorporated object provides insight into the detailed internal structure of the *vP*. The data presents a complex problem for the linearization of suffixal versus prefixal heads and modifiers, which may potentially challenge the Final-Over-Final constraint. The properties of the IT antipassive also suggest a specific relation between antipassivization and incorporation: antipassives produce derived incorporation constructions, capable of licensing a *vP*-internal NP object.

References

Aissen, J. 1992. Topic and focus in Mayan. *Language* .

- Baker, M. 1988. *Incorporation: A theory of grammatical function changing*. Chicago University Press.
- Baker, M. 2014. Pseudo noun incorporation as covert noun incorporation: Linearization and crosslinguistic variation. *Language & Linguistics* 15:5–46.
- Belvin, R. S. 1985. Nisgha syntax and the ergativity hypothesis: An analysis using the Government and Binding model. In *Papers for the 20th International Conference on Salish and Neighbouring Languages*, 25–76.
- Belvin, R. S. 1997. The causation hierarchy, semantic control and eventivity in Nisgha. In *Theoretical issues at the morphology-syntax interface*, eds. A. Mendiko-Etxea & M. Uribe-Etxebarria, 35–53.
- Biberauer, T., A. Holmberg & I. Roberts. 2014. A syntactic universal and its consequences. *Linguistic Inquiry* 45:169–225.
- Biberauer, T., G. Newton & M. Sheehan. 2009. Limiting synchronic and diachronic variation and change: The Final-over-Final constraint. *Language and Linguistics* 10:701–743.
- Boas, F. 1902. Tsimshian texts. Washington DC: Bureau of American Ethnology.
- Boas, F. 1911. Tsimshian grammar. In *Handbook of American Indian Languages*. Washington: Government Print Office. Bulletin 40, volume 1.
- Borer, H. 2005. *The normal course of events*. Oxford University Press.
- Brown, C. 2016. Extraction restrictions in Gitksan. Master’s thesis, McGill University.
- Brown, C., C. Forbes & M. D. Schwan. 2020. Clause-type, transitivity, and the transitive vowel in Tsimshianic. In *Papers of the International Conference on Salish and Neighbouring Languages* 55. UBCWPL.
- Bruening, B. 2001. Syntax at the edge: Cross-clausal phenomena and the syntax of Passamaquoddy. Ph.D. thesis, MIT.
- Bruening, B. 2005. The Algonquian inverse is syntactic: Binding in Passamaquoddy. Manuscript, University of Delaware.
- Carnie, A., S. A. Dooley & H. Harley (eds.) . 2005. *Verb First: On the Syntax of Verb Initial*

- Languages*. John Benjamins Publishing Company.
- Carnie, A. & E. Guilfoyle (eds.) . 2000. *The syntax of verb-initial languages*. Oxford University Press.
- Carnie, A., H. Harley & E. Pyatt. 2000. VSO order as raising to Comp. In *Carnie & Guilfoyle (2000)*, 39–60.
- Chung, S. 1998. *The design of agreement*. University of Chicago Press.
- Chung, S. & W. Ladusaw. 2004. *Restriction and saturation, Linguistic Inquiry Monographs*, vol. 42. MIT Press.
- Clemens, L. E. 2014. Prosodic noun incorporation and verb-initial syntax. Ph.D. thesis, Harvard University.
- Clemens, L. E. 2019. Prosodic noun incorporation: The relation between prosody and argument structure in Niuean. *Syntax* .
- Clemens, L. E. & J. Coon. 2018. Deriving verb-initial word order in Mayan. *Language* 94(2):237–280.
- Clemens, L. E. & M. Polinsky. 2017. Verb-initial word order, primarily in Austronesian and Mayan languages. In *The Wiley Blackwell Companion to Syntax*, eds. M. Everaert & H. van Riemsdijk, 1–50. John Wiley & Sons, Inc, 2 edn.
- Coon, J. 2010. VOS as predicate fronting in Chol Mayan. *Lingua* 120:345–378.
- Cuervo, M.-C. 2014. Alternating unaccusatives and the distribution of roots. *Lingua* 141:48–70.
- Davis, H. 2018. Only connect! a unified analysis of the Tsimshianic connective system. *International Journal of American Linguistics* 84(4):471–511.
- Davis, H. & J. Brown. 2011. On A'-dependencies in Gitksan. In *Papers for the 46th International Conference on Salish and Neighbouring Languages*, 43–80. UBC Working Papers in Linguistics.
- Davis, H. & C. Forbes. 2015. Connect four! The morphosyntax of argument marking in Tsimshianic. In *Papers for the 50th International Conference on Salish and Neighbouring Languages*, vol. 40, eds. N. Weber, E. Guntly, Z. Lam & S. Chen, 155–185. UBCWPL.

- Davis, H., C. Gillon & L. Matthewson. 2014. How to investigate linguistic diversity: Lessons from the Pacific Northwest. *Language* 90(4):e180–e226.
- Dunlop, B., S. Gessner, T. Herbert & A. Parker. 2018. Report on the status of BC First Nations languages. Report of the First People’s Cultural Council. URL <http://www.fpcc.ca/files/PDF/FPCC-LanguageReport-180716-WEB.pdf>, retrieved March 24, 2019.
- Erlwine, M. Y., T. Levin & C. van Urk. 2018. The typology of nominal licensing in Austronesian voice languages. Poster presented at LSA 92.
- Forbes, C. 2012. Gitksan adjectives: evidence from nominal modification. In *Papers for the 47th International Conference on Salish and Neighbouring Languages*, 49–68. UBC Working Papers in Linguistics.
- Forbes, C. 2018. Persistent ergativity: Agreement and splits in Tsimshianic. Ph.D. thesis, University of Toronto.
- Forbes, C. 2019a. On binding and precedence in Gitksan. In *Wa7 xweysás i nqwal’utteníha i ucwalmícwa: He loves the people’s languages. Essays in honour of Henry Davis*, vol. 6, eds. L. Matthewson, E. Guntly & M. Rochemont, 111–126. UBC Occasional Papers in Linguistics.
- Forbes, C. 2019b. The structure of transitivity in Gitksan. In *Proceedings of the 54th International Conference on Salish and Neighbouring Languages*, 63–85. UBCWPL.
- Forbes, C. to appeara. Consequences of long-distance extraction morphology in Gitksan. In *Proceedings of the Workshop on Structure and Constituency in Languages of the Americas 22*. UBC Working Papers in Linguistics.
- Forbes, C. to appearb. Nominal types in Gitksan split-absolutive agreement. *Natural Language and Linguistic Theory*.
- Givón, T. 1994. The pragmatics of de-transitive voice: Functional and typological aspects of inversion. In *Voice and Inversion*, ed. T. Givón. John Benjamins Publishing Company.
- Harley, H. 2013. External arguments and the Mirror Principle: on the distinctness of Voice and v. *Lingua* 125:34–57.
- Holmberg, A. 2000. Deriving OV order in Finnish. In *Linguistic Aktuell*, 31, 123–152. John

- Benjamins.
- Hunt, K. 1993. Clause structure, agreement and case in Gitksan. Ph.D. thesis, University of British Columbia.
- Jelinek, E. 1986. The ergativity hypothesis and the argument hierarchy in Nisgha. In *Papers for the 21st International Conference on Salish and Neighbouring Languages*. Seattle, WA.
- Kayne, R. 1994. *The Antisymmetry of Syntax*. Cambridge: MIT Press. Linguistic Inquiry Monograph 25.
- Kratzer, A. 1996. Severing the external argument from its verb. In *Phrase structure and the lexicon*, 109–137. Springer.
- Levin, T. 2015. Licensing without Case. Ph.D. thesis, MIT.
- Madeiras, D. 2013. Hawaiian VP-remnant movement: a cyclic linearization approach. *Lingua* 127:72–97.
- Massam, D. 2000. VSO and VOS: Aspects of Niuean word order. In [Carnie & Guilfoyle \(2000\)](#), 97–116.
- Massam, D. 2001. Pseudo noun incorporation in Niuean. *Natural Language and Linguistic Theory* 19:75–134.
- Massam, D. 2020. *Niuean: Predicates and arguments in an isolating language*. Oxford University Press.
- Mulder, J. 1994. Ergativity in Coast Tsimshian (Sm'algyax). Ph.D. thesis, UC Berkeley.
- Paul, I. 2000. Malagasy clause structure. Ph.D. thesis, MIT.
- Polinsky, M. 2017. *Antipassive*. Oxford University Press.
- Pylkkänen, L. 2008. *Introducing Arguments*. MIT Press.
- Ramchand, G. 2016. *Situations and Syntactic Structures: Rethinking Auxiliaries and Order in English*. MIT Press.
- Rigsby, B. 1986. *Gitksan Grammar*. Ms., University of Queensland, Australia.
- Ross, J. 1974. Three batons for cognitive psychology. In *Cognition and the symbolic processes*, eds. W. B. Weimer & D. S. Palermo. Lawrence Erlbaum Associates.

- Sasama, F. 2001. A descriptive study of the Coast Tsimshian morphology. Ph.D. thesis, Kyoto University.
- Tarpent, M.-L. 1987. A grammar of the Nisgha language. Ph.D. thesis, University of Victoria.
- Tarpent, M.-L. 1988. Below the surface of Nisgha syntax: Arguments and adjuncts. In *Papers for the 23rd International Conference on Salish and Neighbouring Languages*. Eugene, OR: University of Oregon.
- Tarpent, M.-L. 2012. Tsimshianic clause structures: Basic and derived. Handout presented at SSILA, Portland OR. August 5-8.
- Travis, L. 2010. *Inner aspect*. Springer.
- van Urk, C. 2019. Constraining predicate fronting. Handout presented at GLOW 42.
- van Urk, C. 2020. Object licensing in Fijian and the role of adjacency. *Natural Language and Linguistic Theory* 38:313–364.
- Wexler, K. & P. Culicover. 1977. Some syntactic implications of a theory of language learnability. In *Formal Syntax*, eds. P. Culicover, T. Wasow & A. Akmajian, 7–60. New York: Academic Press.
- Zubizarreta, M. L. & R. Pancheva. 2017. A formal characterization of person-based alignment: The case of Paraguayan Guaraní. *Natural Language and Linguistic Theory* 35(4):1161–1204.