

How Language Could Have Evolved

Kenneth W. Del Signore
kendesignore@gmail.com
North Aurora, Il.

Abstract: This paper develops a biologically inspired computational model of the Human language faculty and some associated thought processes. This model is developed starting from a simple proto-language, which humans are assumed to have inherited at speciation. This proto-language consists of single symbol exchange using a small set of symbols; similar to the observed dialogue systems in the existing Great Ape families. Computationally, the model is built using a single class with the form of a Markov graph node. Instances of this node class are used to symbolically represent words. The model is built iteratively in main() as a single graph. Nodes are added to this graph using a merge, or conjunctive join, operation between two existing nodes, notionally labeled as head and copy. A simple first order graph is developed which is hypothesized to be common to all Mammals and to generate shared mammal behaviours. This graph is then extended into an interactive c++ prototype that allows for more complex human language phenomena, including adverb periodicity, movement, illicit grammar detection, conjunction, 3rd person verb marking, irregular verbs, adverb ordering, and the progressive and perfected tenses.

Table of Contents

Introduction	2
derivation	3
short term memory	5
long term memory	9
simple protolanguage	10
the symbols bifurcate	13
the number line	17
adverb periodicity	19
conjunctions	21
compare function at the merge	22
direct object	23
verbs and prepositions	24
adjective ordering	26
third person thing	28
past and future	29
irregular past tense	31
progressive and perfected	32
summary	35

Introduction

The simplest possible dialogue is a single symbol, exchanged from one communicator to another. As an example, consider a hiker that is lost in the woods and builds a pile of rocks, and then moves on. If a second hiker subsequently finds the rocks, then we can say that a single symbol has been exchanged. The information conveyed is the same as if the first hiker had just stood next to the second and said the adverb “here”, except that the hiker said “here” some long time prior and the symbol (the rocks) held the information through time. There is no other temporal or spatial information conveyed.

To modify this example, if while the hiker is piling the rocks, s/he hears the second hiker coming straight on and calls out “here”, then the second hiker will have, at the simplest, one additional quanta of information, namely a measured value of the distance. This second quanta is analogous to a floating point variable that can take on a continuous value or the variable firing rate of a spiking neuron.

Single symbol dialogue systems are observed throughout the animal and plant kingdoms. The symbol “here” is often the exchanged symbol in these systems. A flower can be interpreted as a single symbol, exchanged between a plant and its pollinators, with the meaning of the flower being “here” [3b]. A symbol is defined to contain two quanta of information: name and value; with value being possibly zero or unspecified. In the examples above, the second communicator measures the value locally to itself using the externalization made by the first communicator.

The neocortex gives mammals the ability to store and recall sequences of symbols with relative ease. This ability gives mammals considerably more complex behavior relative to non mammals. Mammals can input and store sequences of symbols in combinations never experienced before and later recall and utilize this information; an example of which would be the second hiker remembering the path out of the woods and walking out with the first hiker.

All known mammal dialogue, excluding human, uses or can be easily reduced to single symbol exchange. The great apes have possibly the most developed system; using a gestural vocabulary of approximately 80 gestures to convey ~15 unique meanings as commands and questions [10b]. The meanings loosely correspond to the hypernym forms of various parts of speech categories [here, no, give, on, on?, play?], which are discussed further below.

Among the Hominins, stone tools provide the first evidence for advancement in behavior. The initial Mode I tools date to 3.3 Mya and remained at a relatively fixed level of design and refinement for over a million and a half years. The early hominins did not evidently undergo much generational change; contrary to the current human cliché “kids these days...”. Mode II tools were then developed and these spread slowly throughout the existing hominin range over the next million years. When humans first speciated, they inherited a Mode II toolkit. They had hafted hand-axes, spears, weathertight huts, and cooked meals, to name a few of their initial conveniences. Hominins had been hunting elephants and hippopotamuses since at least 400

Kya and early human sites dated 200 Kya also contain evidence that they subsisted on these animals [].

Humans then began making rapid advances to their toolkits and left Africa approximately 75 Kya. The sudden change to the rate of change of the toolkit just prior to leaving Africa is suggestive that, at the simplest, a single change could have taken place in the hominins to allow them to make these advances. Our current human language (faculty) is argued to be this change [3]. The use of complex sentences would presumably have allowed the hominins to more easily accumulate knowledge and transfer it to each other and their children. Daily storage and recall of unique sequences would also permit hominins the ability to mentally reconstruct scenarios after they occurred, which would allow them to explain them to others and explore possible solutions when time permits.

All available evidence indicates that the current human language faculty and cognitive functionality was completely formed before humans left Africa and that it hasn't changed since [3a]; which would be a signature of the single change in Africa hypothesis. The argument for this is that babies from any culture can grow up in any new culture and will readily acquire the new culture and language, which is taken to imply that no changes to the human language faculty or other cognitive functions have occurred in humans since we left Africa.

For the present inquiry, the two main historical developments of interest are the mammalian neocortex and the human toolkit change. The neocortex is viewed as having endowed mammals with the ability to conceptualize symbols, to form vocabularies of these symbols, and to [input, store, and utilize] sequences of random combinations of these symbols. The human change is viewed as happening when the neocortex became large enough to support a new thought process and/or a new thought process was developed.

Derivation

We begin with one of the main minimalist assumptions of linguistics, namely that communicators have some common internal neurological/symbolic representation of each word in their vocabulary. This is shown as the two blue "interface parcels" in the diagram below, which borrows from similar diagrams in references [4] and [3]. In this example, while walking out of the woods, the two hikers roust a duck, which causes the duck symbol to activate in each hiker's interface parcel. We assume that each hiker processes their unique neural input of the event and each conceptualizes, or activates, an internal symbol that corresponds to "duck". Also note that if one of the hikers is replaced by another mammal, such as a dog, the presumed interface parcel would still be valid, although possibly with 'duck' replaced by a 'squirrel'.

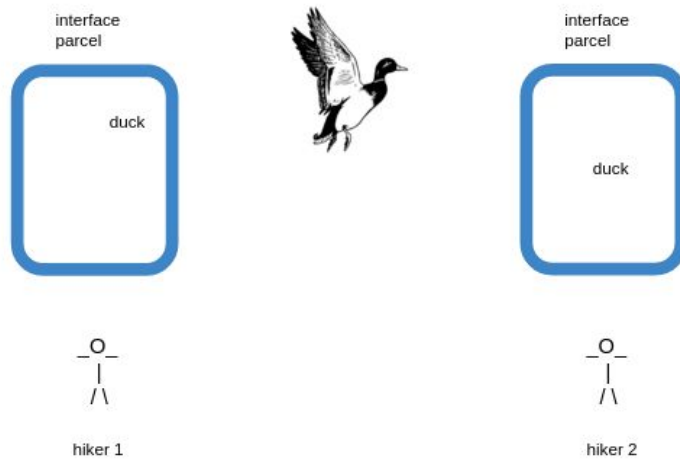

Figure : 1 The rousting of the duck provides unique sensory input to each hiker’s interface parcel, which we assume causes the “duck” symbol to fire (or conceptualize) therein. This is posited to occur as some subset of the nodes in the interface parcel firing into a stable attractor state.

For our initial purposes we assume that some analogous neural parcel exists that contains many neural attractor states that represent words or symbols. Such a neural parcel can be thought of as analogous to a two dimensional optical character recognition neural network, wherein each character is a unique attractor state of the OCR neural network. Each character corresponds to a subset of nodes in the 2d array that fire and lock into the active state when the array is input a noisy bitmap of a scanned character and allowed to run freely into the nearest attractor state.

The symbols in this interface parcel, once formed, are assumed capable of subsequent re-activation on similar input. Furthermore, once activated, we assume that the symbols retain this state information for a short time and are more easily re-activated [9]. This is analogous to the human ability to be given a random word and then be able to repeat that word on command some short time later.

The interface parcel can be abstracted to represent all of the symbols that we are physically able to internalize and externalize. The temporal sequence of all such symbols can be thought of as our stream of consciousness.

Short Term Memory (stm):

Behaviours involving short term memory are easily observable in mammals and many other animals. In humans, we can easily form stm associations between any two randomly picked symbols in our vocabularies.

As an example, we can extend the duck scenario above such that the surprise of the duck rousting causes the first hiker to sneeze. Following this, the second hiker's interface parcel would contain the activated symbols "duck" and "sneeze" and these would be stm bound such that if some short while later a second duck was roused, then this would cause the second hiker to recall the sneeze symbol and to expect the first hiker to sneeze again. We can say that the second duck caused the hiker to "think of" the sneeze symbol.

Such a random two symbol stm mechanism can be built by the current model using the assumed node functionality. We (hypothetically) introduce many additional nodes to the interface parcel, referred to as stm nodes. These stm nodes are assumed to be equivalent to the symbol nodes except that they are unlabeled. The stm nodes are assumed to be randomly and sparsely connected to the labeled symbol nodes [13][14].

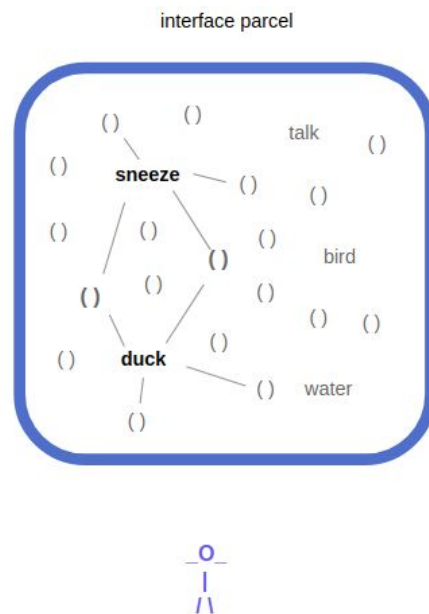

Figure : 2

When two random symbol nodes, such as duck and sneeze, are activated and fire, they each provide input activation to their respective stm nodes. If a subset of these stm nodes is common to both symbols, this subset can become activated over background due to having 2x more input activation than the stm nodes that are not common. The elevated input level then persists in time, allowing for subsequent short term associative recall.

Computationally, stm memory can be implemented as a single node created by a merge function between a root node “ip” and its child nodes as shown below. The (stm) nodes are created by the merge function that runs each time a node fires. Bidirectional connectivity is assumed possible in all connections.

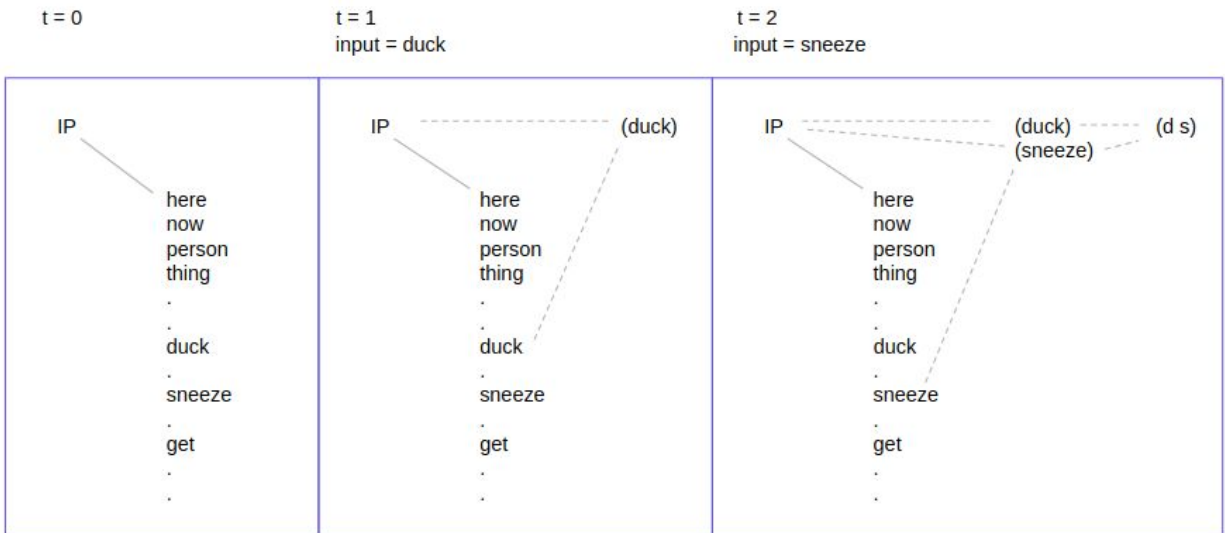

Figure 3

The merge operation can be applied recursively between other recent stm nodes to create the (d s) node above right. This node then stores the short term association between duck and sneeze.

The stm nodes are created at run time using a merge constructor function of the Node class as shown below. This function takes two nodes as input, labeled “head” and “copy”. Bidirectional links are set up between the head and copy nodes in the merge constructor function.

```

class Node {
    string    symbol
    float    value           // [-1, 0, 1] = F, ?, T

    int      input_level    // current value
    int      thresh_hold    // threshold to fire

    int      merge_time     // threshold to merge

    pair< Node*, int weight >  head
    pair< Node*, int weight >  copy
    list < pair< Node*, int weight > > branches

    list < pair< Node*, int time> > touches // list of nodes that
                                           // touched this node

    Node()                // base constructor
    Node( string, head )  // string constructor
    Node( head, copy )    // merge constructor

    touch ( weight, node, depth )
    output ( tabs, depth )
};

```

```

main() {
    Node ip( "ip", null )
    Node head( "head", ip )
    Node copy( "copy", ip )

    Node copy'( head, copy )
};

```

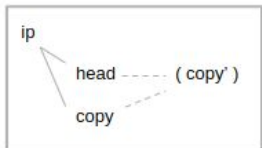
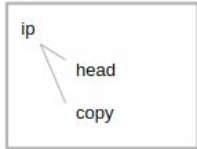

Figure 4 The Node class and the use of the constructor functions in main().

The sequence: "hiker rocks" is input with the "touch" function calls in main() as shown below.

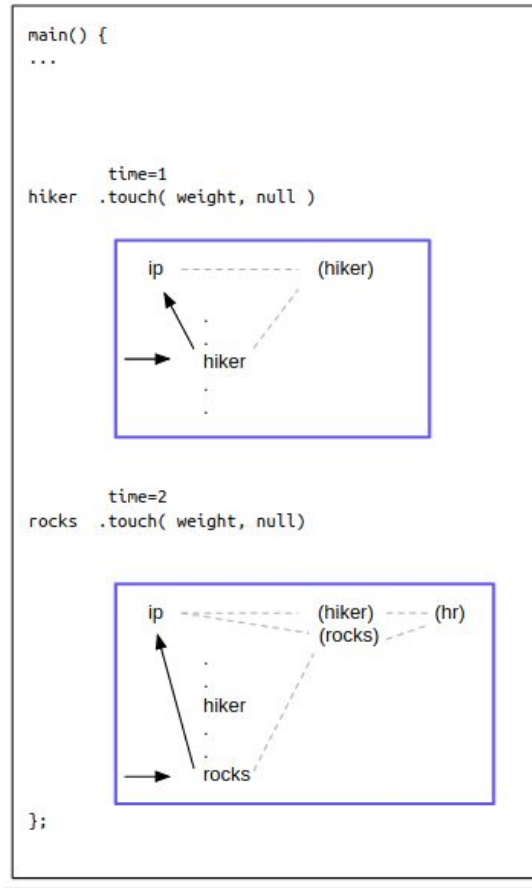

Figure 5 The hiker.touch() function call causes the hiker node to fire, which then causes the (head) ip node to fire. The stm merge node is created when the ip node fires.

The stm structure grows iteratively as more symbols are input.

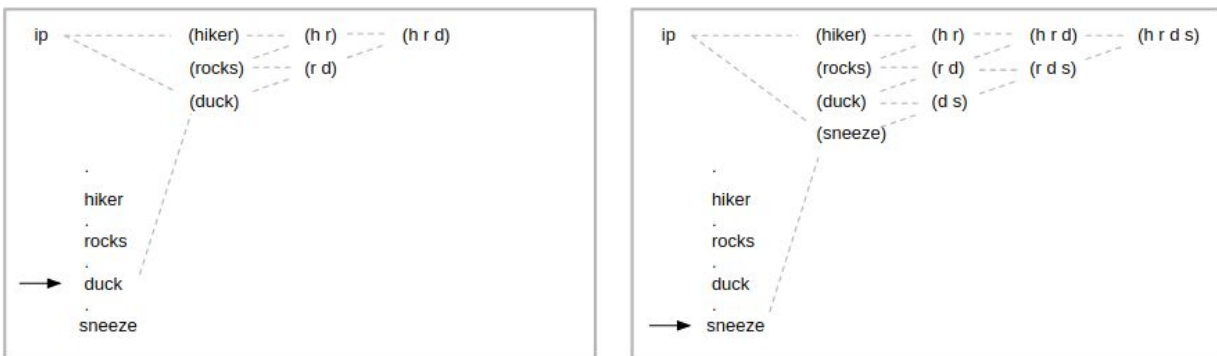

Figure 6

The structure formed in (stm) memory can then be used for output of the hiker, rock, duck, sneeze symbols. Using the recursive algorithm shown in the pseudo code, the symbols can be output in the order that they occurred. In the prototype c++ code given in Appendix B, a flag is added to the Node class to limit each node to firing only one time and the printout of the ip node is suppressed.

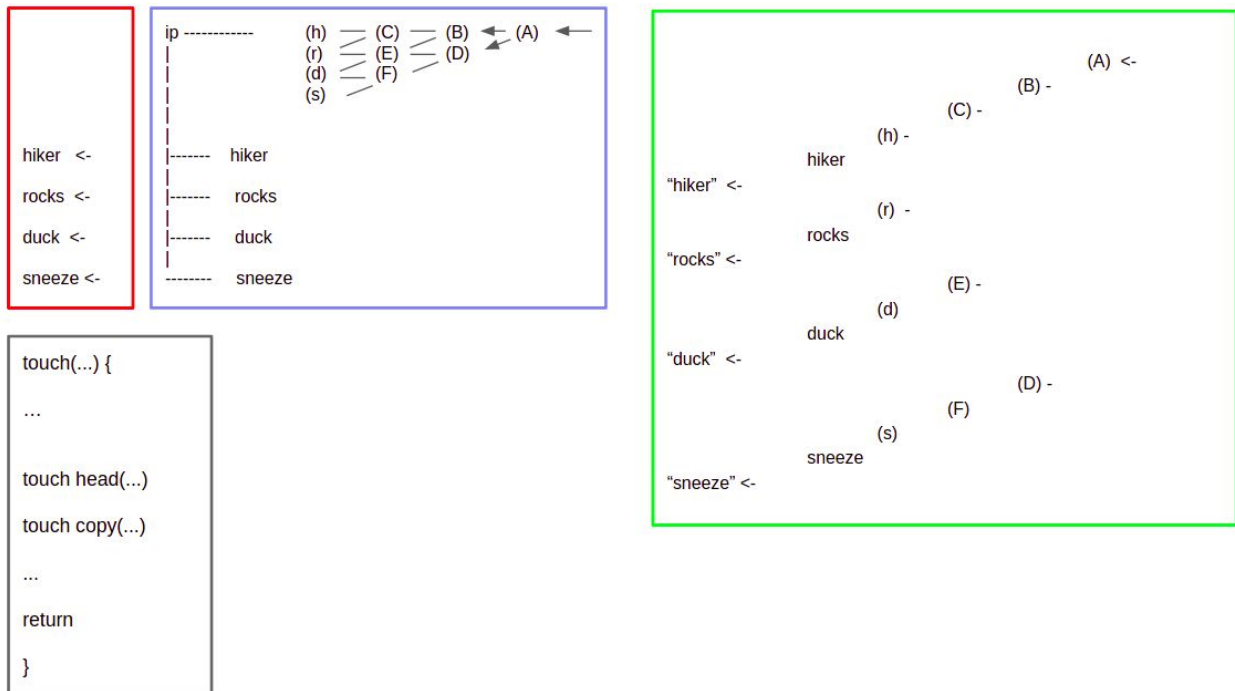

Figure 7

Simple Proto Language

Following the suggestion of ref. [3], we assume a simple (truncated english) corpus of the form: [here now feeling me thing get do go]. This corpus is drawn from the hypernym forms of the parts of speech: [adverb noun verb]. The verbs are taken from the hypernym verb set: [get feel do go], which is discussed below and in appendix A.

This initial corpus is similar to the reported meanings exchanged in chimpanzee gestural dialogues. The table below is drawn from the meanings derived from a large video corpus of wild chimpanzee single symbol dialogue exchanges [10]. The meanings are mapped to a part of speech and then to a hypernym word for that POS. The verb POS forms labeled 'point' and 'line' correspond to [do go].

gesture	meaning	part of speech	hyponym form
grab, ...	stop that	negative	stop
mouth stroke, ... bite, ...	acquire object contact (affection)	verb - get verb - feel -?	give touching
big loud scratch	init grooming	verb - point	do
arm swing, ... beckon, ...	move away move closer	verb - line - negative verb - line	go come
big loud scratch jump, ... foot present, ... reach	travel with me follow me (sex) climb on me climb on you?	prep prep prep ?	with with on on?
present location	groom here	adverb - here	here
leaf clipping, punch ground leaf clipping	sexual attention: male female	? ?	flirt flirt

Figure: 9 The chimpanzees exchange approximately 15 unique meanings using gestures. The hypernym forms are mapped to the closest meaning and can all be nominally matched. No grammar or random combinatoric use of gestures is observed. All species of Great Apes share a common set of ~100 gestures with each species using a subset of ~60 gestures. The gesture to meaning mapping is different in every species.

The apes use multiple gestures per meaning and young adult apes are sometimes observed to cycle through these as a repetitive sequence of gestures, suggestive of a hypernym-hyponym structure [10a].

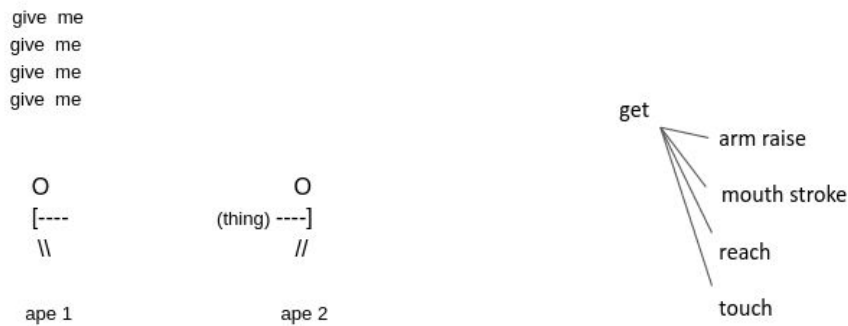

Figure: 10

Switching back to humans, our understanding of the neocortex is expanding at a great rate using many types of experimental methods. fMRI experiments in [2][2a] have identified two voxels ($<2\text{mm}^3$) that fire in response to words that are hyponyms of ~(person/place) and (thing). Movies are shown to volunteers and the hypernym mappings from WordNet are used to tag 1800 nouns from the movie dialogues to person, place, or thing. In all volunteers, these two voxels can be identified in similar locations on a neocortex flatmap and show activation when the corresponding hyponym words are used in the movie dialogues.

The symbols of the proto-language are assumed to be formed as child nodes in the interface parcel as shown. The stm memory allows for storage of state information and for simple dialogues.

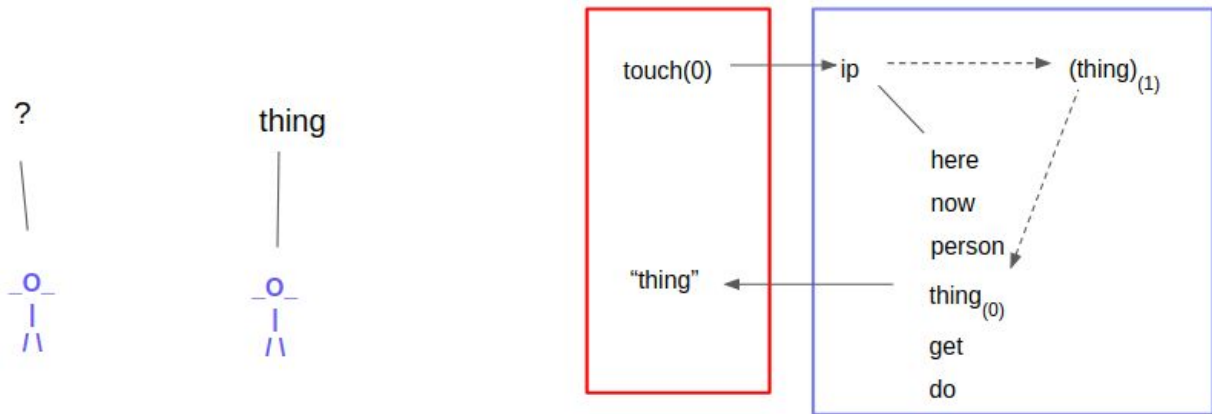

Figure 11 The value of zero passed in the touch(0) function indicates a question; -1, 0, 1 = [no, ?, yes]. The simplest input form of a question is the function call: ip.touch(0). The stm (thing) node is assumed to have been previously formed.

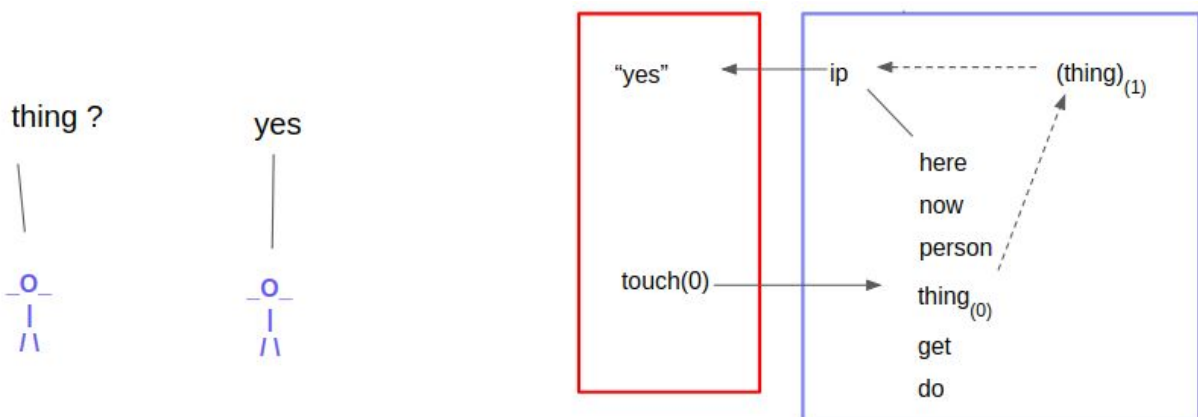

Figure 12 all symbols can be input as questions with the touch(0) function call as: thing.touch(0) .

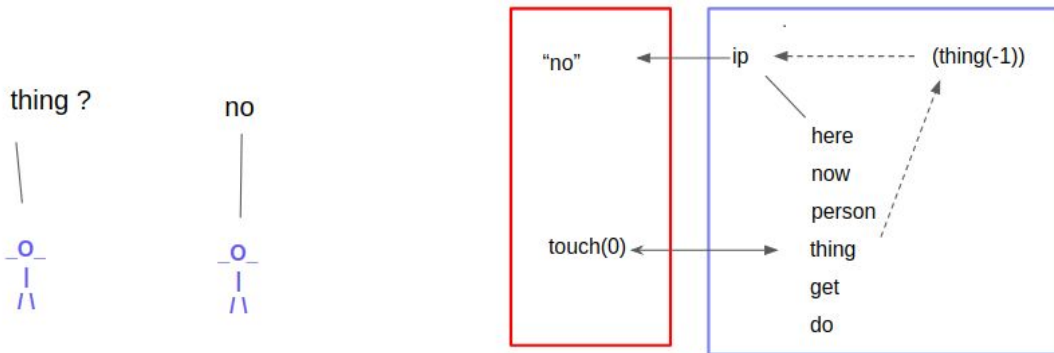

Figure 13 an stm node having a value = -1 indicates negation. In this scenario, (thing(-1)) was previously created via an stm merge

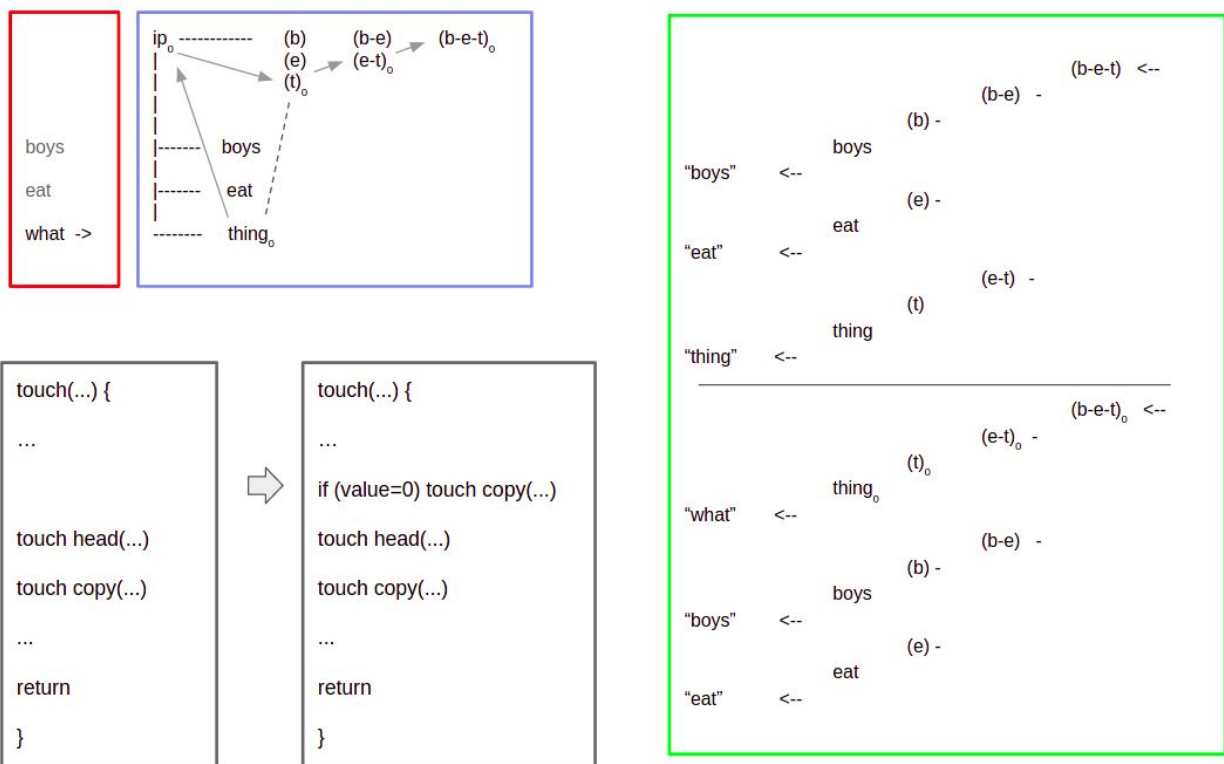

Figure 14 A mechanism for movement can be implemented using the stored values in the (stm) nodes. The input value is propagated to the (stm) nodes as shown, and the single line modification to the pseudocode will alter the output ordering from "boys eat what" to "what boys eat".

The symbols bifurcate to the first two hypernyms

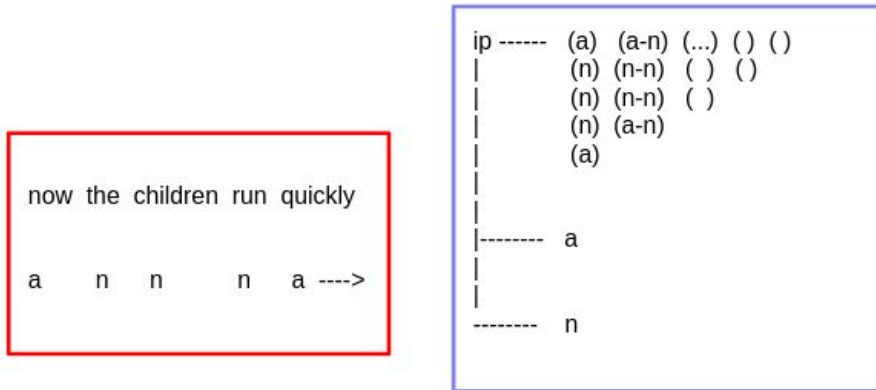

Figure 14 The words in the sentence are mapped to 'a' or 'n'. Each sentence in the wordnet corpus (120K definitions + 60K glossary sentences) can be mapped into such sequences and used for training input.

A long term memory [ltm] node can be made at the time the (stm) node is made by the merge() function. The two nodes can also be connected by the merge function. The [ltm] node retains the label of the copy node as shown.

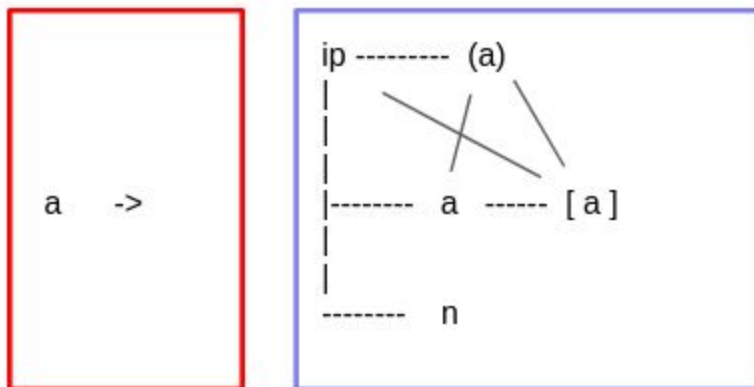

Figure 15 A long term memory node is formed by a reverse merge operation. The weights of the [ltm] nodes are initialized differently than the (stm) node and are then modified by a simple Hebbian mechanism that runs when the node fires. Weights are decreased when a node is touched, and increased if the touched node subsequently node fires.

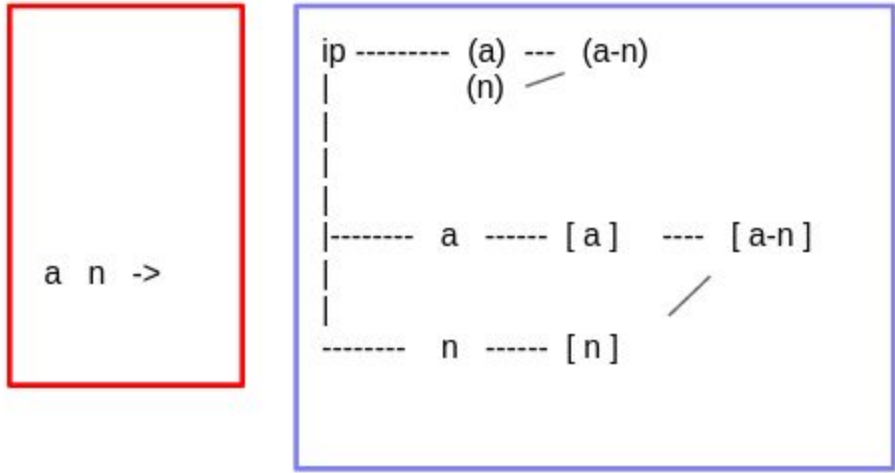

Figure 16 The first level [lrm] nodes, once formed, form sequential associations using the same mechanism as the (stm) nodes.

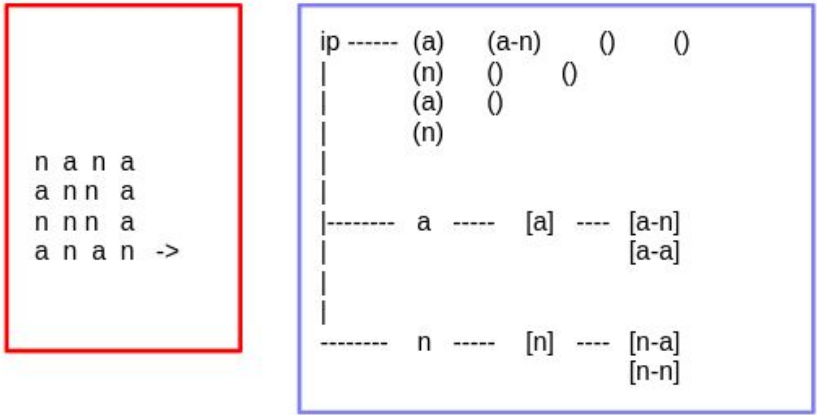

Figure 17 random corpus input produces multiple [x-y] child nodes under the [a] and [n] branches.

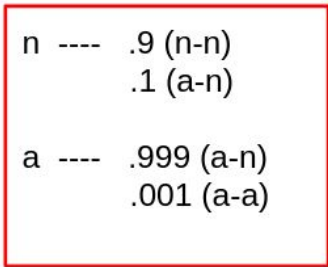
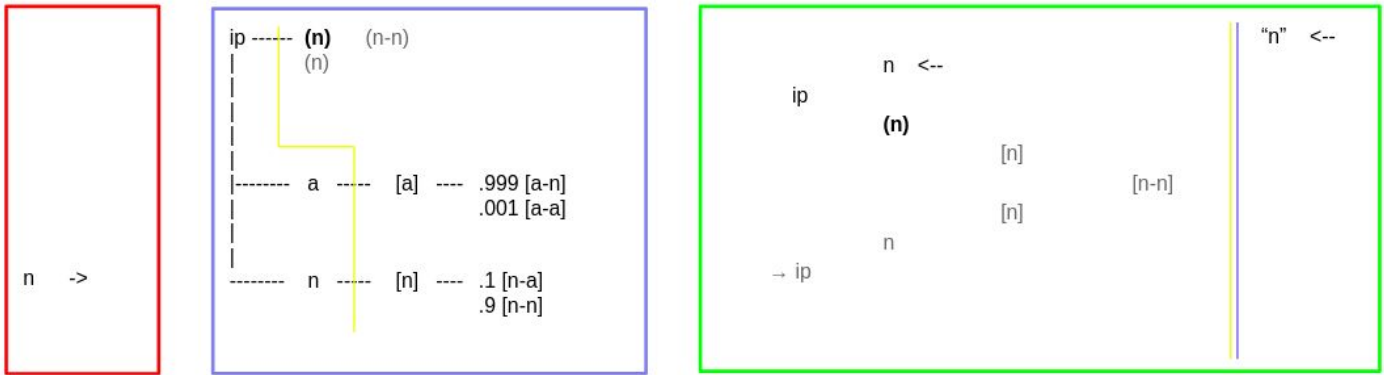

Figure: 18 the first level (fastest) prediction of the most probable next symbol using **one** level deep stored information

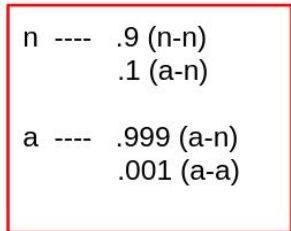
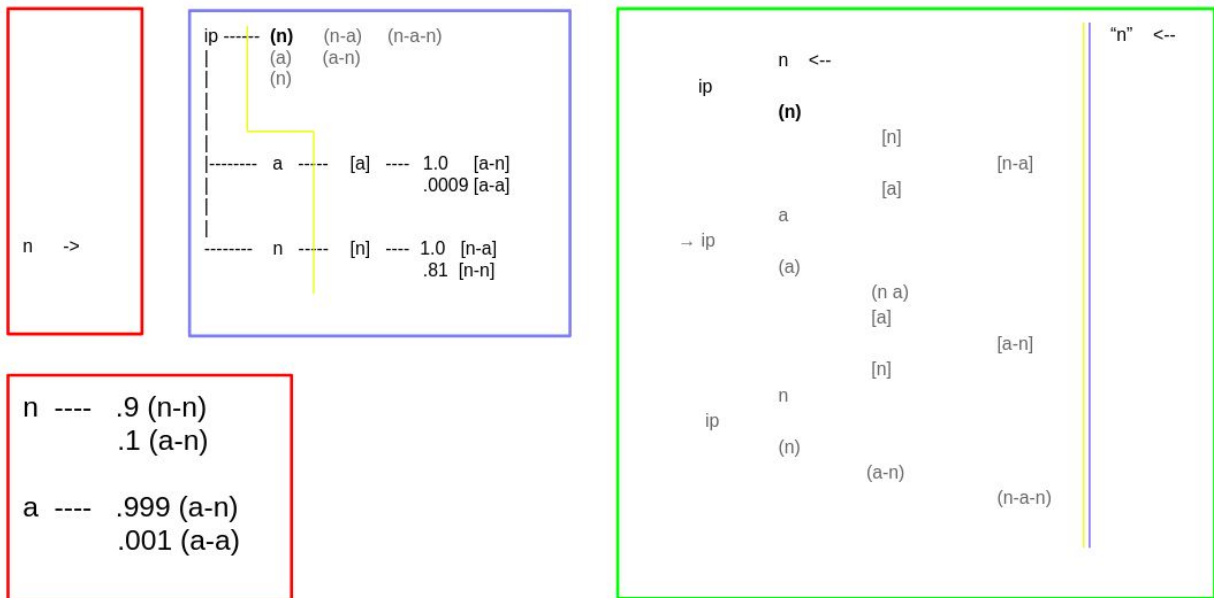

Figure 19 prediction of the next two symbols, with the lowest chance of being incorrect, using the first level branching probabilities predicted out to **two** symbols. The 'a' symbol is assumed optional and does not count as incorrect if not present.

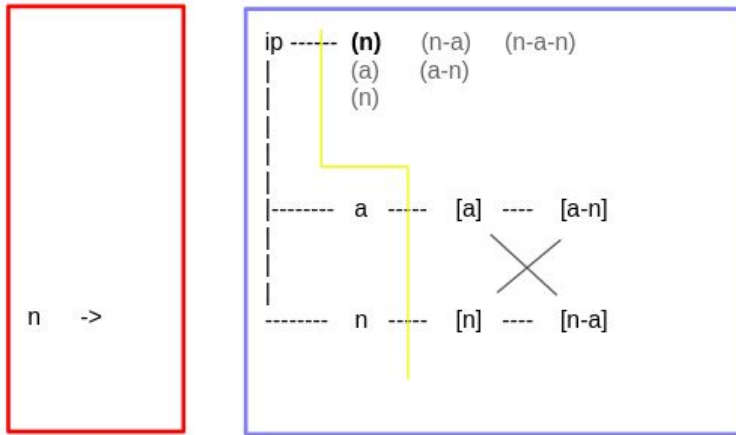

Figure 20 The ltm nodes can drive an oscillating 'n a n a...' pattern in stm memory.

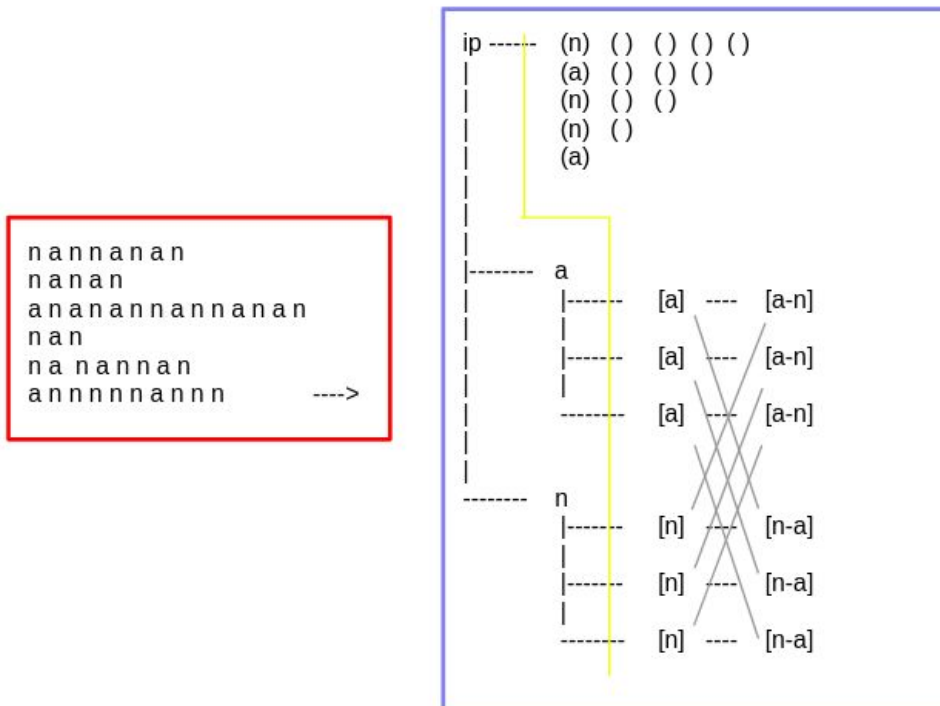
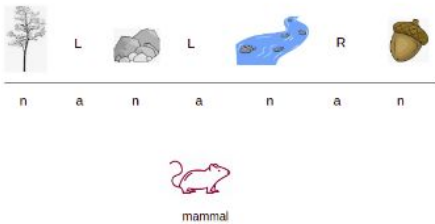
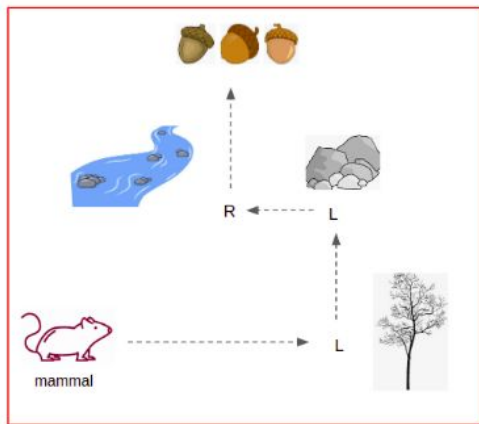

Figure 21 The number line structure forms as [ltm] nodes in the main 'a' and 'n' branches through repeated input cycles with Hebbian mechanisms.



yes₊ / ?₀ / no₋

left₋ / right₋ ->

tree --->
 rock --->
 water --->

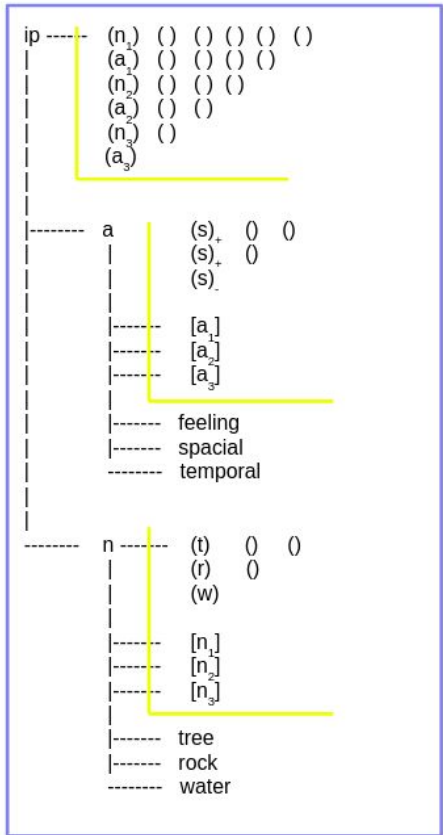

Figure: 22 Assuming the mammal was randomly searching, when it finds a goal, it retains the recent path information and will create an [itm] memory structure that can be recalled and used to regenerate the (stm) memory connections in the ip graph.

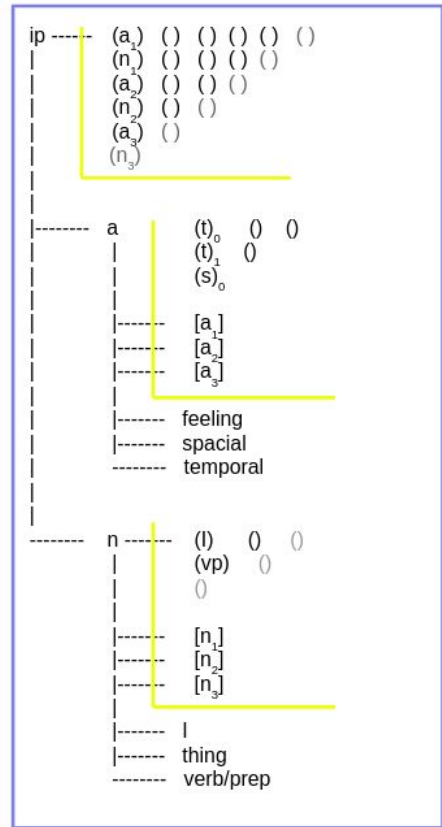
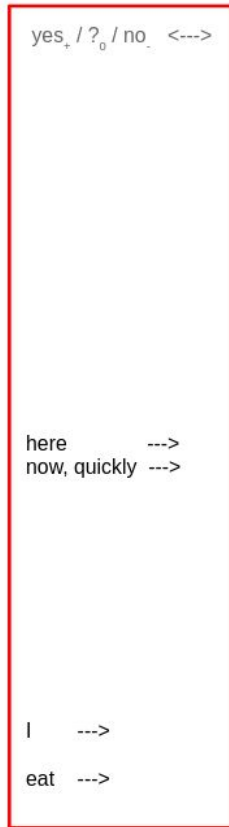
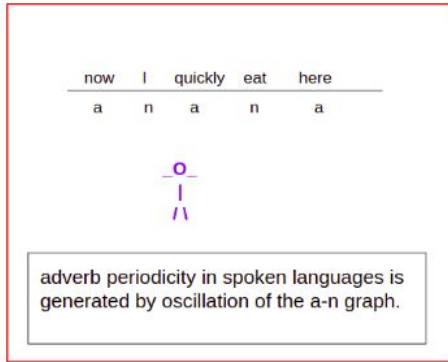

Figure 23 Oscillation of the a-n branches produces adverb periodicity in the spoken languages.

Conjunctions:

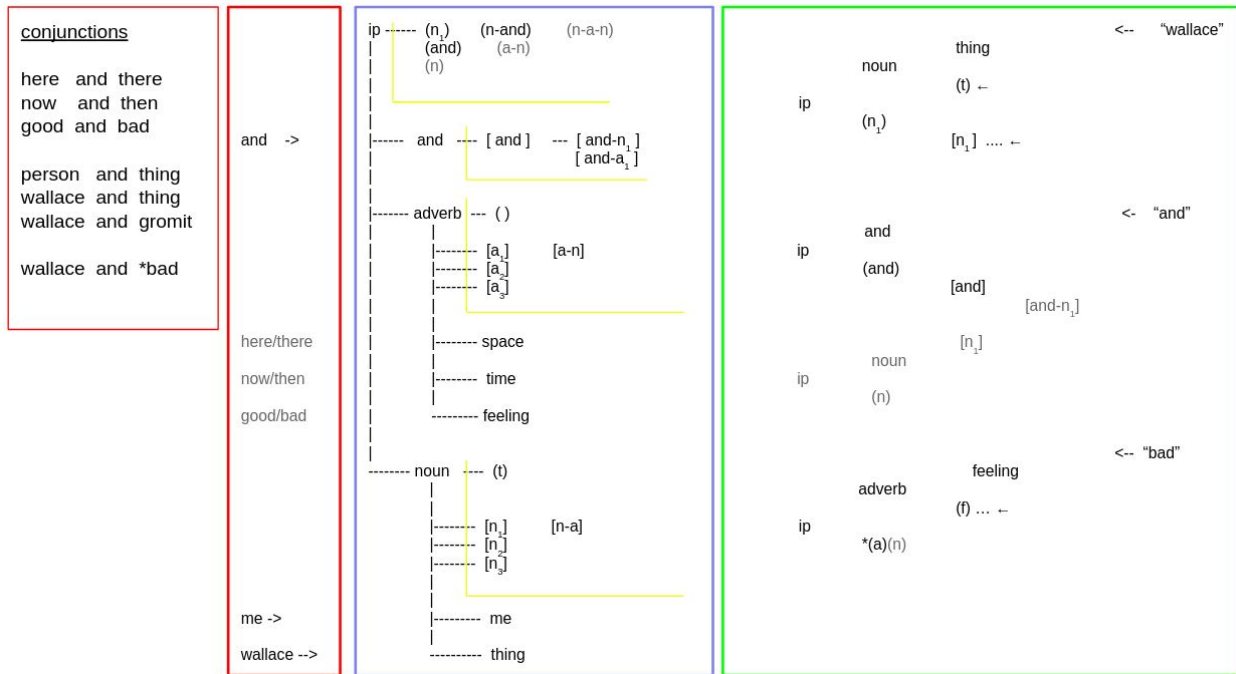

Figure 25 The “and” node is manually added as a child node of IP. The and node functions to predict the next (stm) symbol based on the previous (stm) symbol. This allows a false signal to occur on subsequent input of a dissimilar symbol: Wallace and *bad.

Compare function at the merge

A compare mechanism exists such that two similar sensations can be compared. A familiar example is hearing the first two intermittent sounds of crunching leaves when someone or something is moving in the woods, relative to a fixed observer. The change in intensity is available at the interface parcel as an internal feedback to the observer.

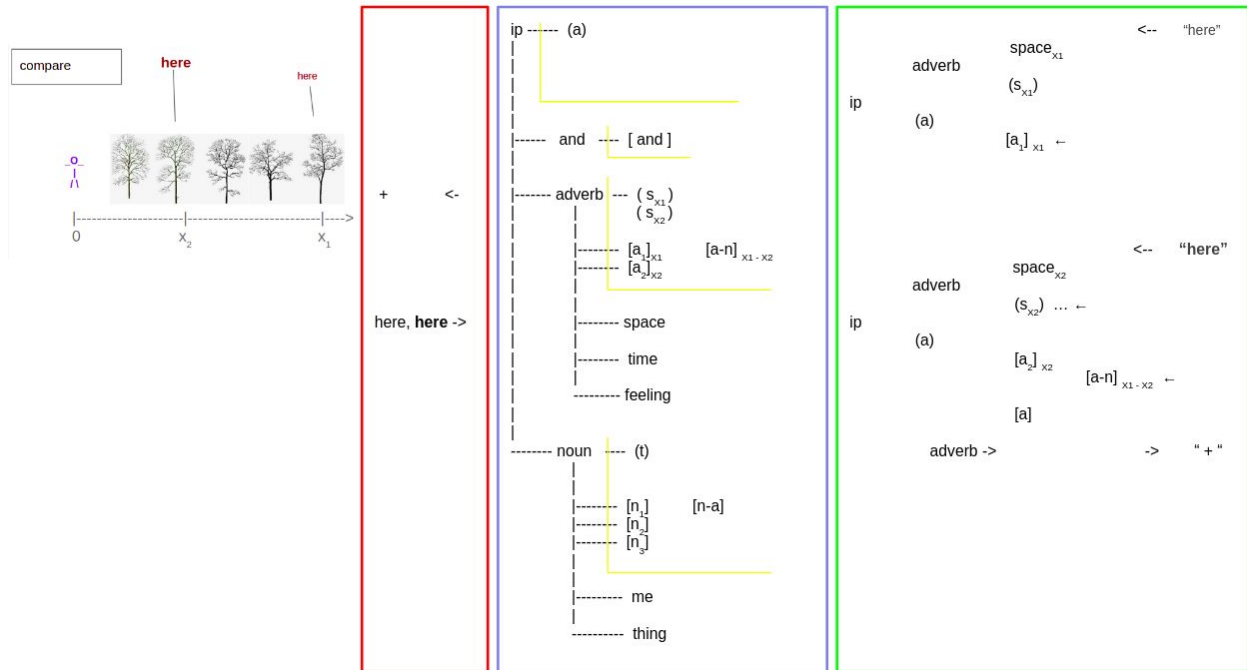

Figure 26 State information is stored in the adverb branch and can be used if a subsequent compare operation.

The ability to compare two of the same sensory inputs separated in time is an important evolutionary advantage to all animals. The initial measured information from each sensation must be stored through time and then compared with the second measurement at a later time. This functionality can be achieved at the second level [Itm] merge, shown above in the adverb branch, using the values of the two parent nodes.

This function, storing a value and using it in a compare operation later in time, is similar to that of the Reichardt model used by Hubel to explain directionally sensitive neural circuits in V1 [9].

The object function

A node labeled 'vp' is manually added. This node will function as the hypernym node for the verbs and prepositions.

The function of verbs and prepositions is to create stm bindings between the nouns.

verbs modify the stm bindings between nouns

prepositions associate the stm bound spatial symbols of the object

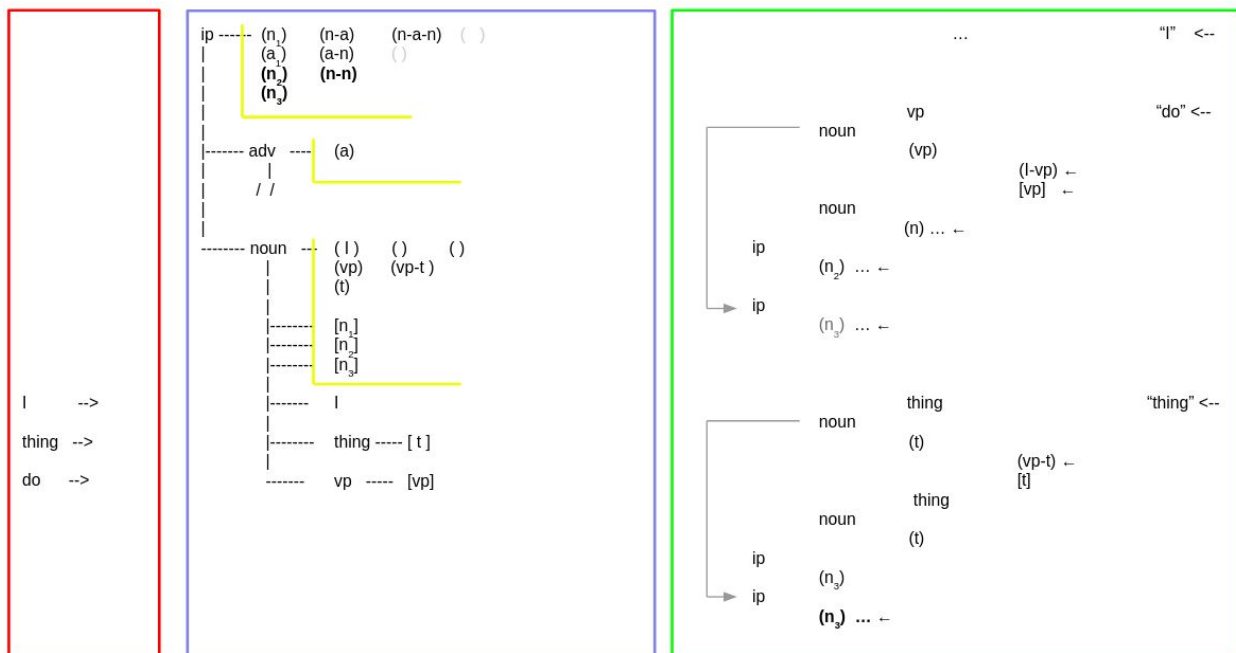

Figure 27 An [itm] sequence [vp] -> [vp-t] -> [t] causes an additional loop to execute in the noun branch, which allows the enhancement of internode connections in the IP (stm) memory, shown in bold.

stm bindings are set when the "thing" node is input, causing the previous stm nodes to refire and allows the node weights to be updated by a Hebbian mechanism. The (n)-(n) bound stm nodes store the predicted next symbol, the object, and can cause a false signal to be returned from the merge function if an (a) symbol fires instead of the predicted (n) symbol, ex: I eat *now it.

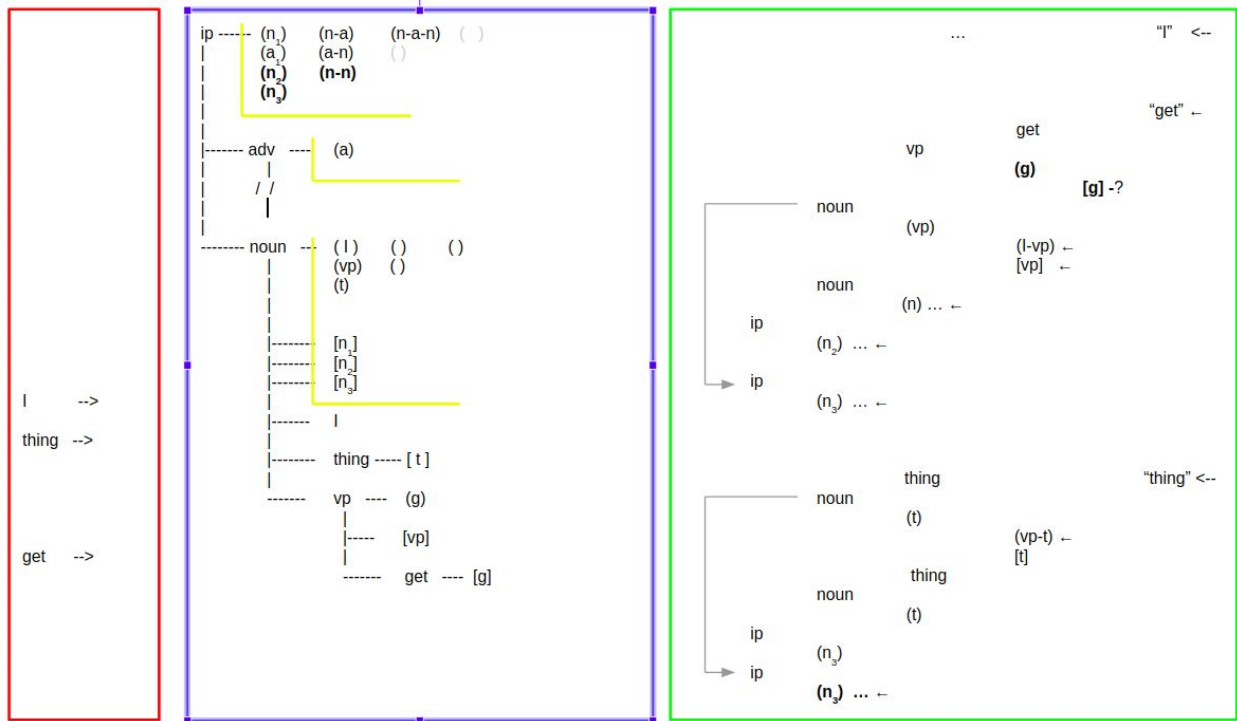

Figure 28 the "get" verb

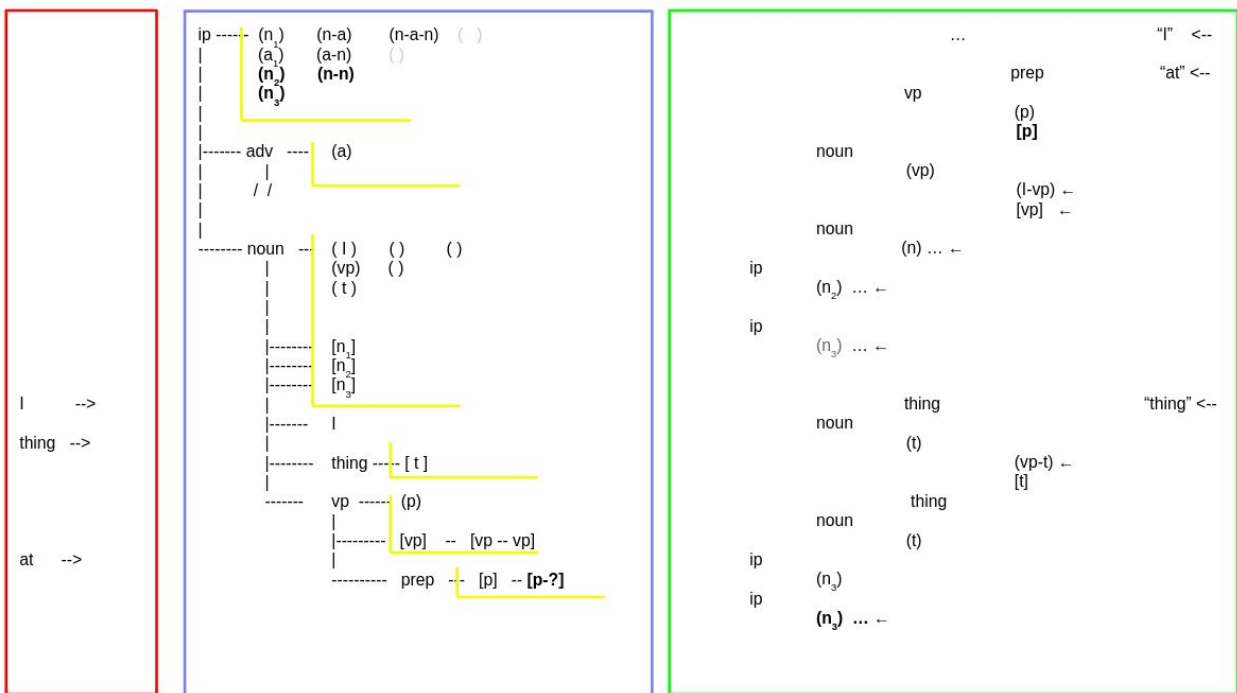

Figure 29 the preposition node

Adjectives

grammar.ccc.commnet.edu/grammar/adjectives.htm#order

THE ROYAL ORDER OF ADJECTIVES								
Determiner	Observation	Physical Description			Origin	Material	Qualifier	Noun
		Size	Shape	Age	Color			
a	beautiful			old		Italian	touring	car
an	expensive			antique			silver	mirror
four	gorgeous		long-stemmed		red		silk	roses
her			short		black			hair
our		big		old		English		sheepdog
those			square			wooden	hat	boxes
that	dilapidated	little					hunting	cabin
several		enormous		young		American	basketball	players
some	delicious					Thai		food

Figure 30

My eight very beautiful small old square English wooden hat boxes

○ / \	my	possession
	eight	number
	beautiful	
	very	intensifier
	small	space
	old	time
	square	space
	English	noun - place
	wooden	noun uncountable
	hat	noun gerund
boxes	noun	

my	car
	the car
my	*the car

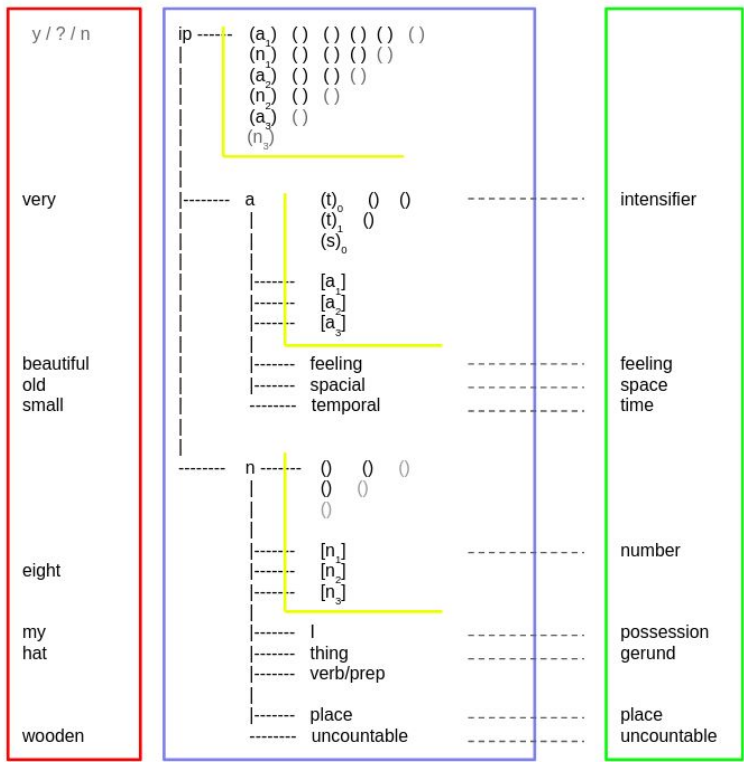

Figure 31 My eight beautiful very small old square English wooden hat boxes. The sequence of adjective archetypes corresponds to the ip subgraphs. Number, feeling, space, time, and noun.

number	feel	space	time	noun
44. first	44. good	22. little	84. new	16. dry
47. two	24. great	22. big	54. old	15. clean
30. most	14. fine	19. small	35. young	12. political
28. very	22. bad	21. large	14. sudden	12. French
23. whole	13. terrible	21. long	14. common	10. wet
21. last	25. cold	20. deep	9. regular	9. liquid
14. few	22. hot	14. thin		9. rope
13. complete	21. light	14. major		9. moon
11. full	20. heavy	14. broken		9. time
14. right	13. rich	13. high		9. power
12. real	13. dull	12. close		9. price
11. special	13. dead	12. direct		8. U.S.
10. single	13. simple	12. local		8. politician
10. same	12. nice	11. short		8. poet
9. free	11. warm	9. flat		8. place
9. typical	11. clear	9. tight		8. landlord
9. highly	11. critical			8. star
	10. quiet			8. trees
	10. soft			8. working
	10. heat			8. critics
	10. hard			8. writer
	10. beautiful			8. plan
	9. mere			8. system
	9. strong			8. economy
	9. bright			

Figure 32 Adjectives from the WordNet corpus, sorted by category and frequency

number	feel	space	time	noun
1368.usually	202.easily	486.widely	354.formerly	83.carefully
1159.especially	79.physically	173.closely	316.early	77.really
696.only	75.brightly	109.directly	129.quickly	73.heavily
303.chiefly	75.badly	92.deeply	112.suddenly	73.naturally
255.highly	72.strongly	83.nearly	112.rapidly	66.friendly
206.relatively	70.lightly	79.clearly	109.originally	52.daily
182.completely	69.freely		92.slowly	45.morally
177.extremely			86.frequently	39.emotionally
168.mostly			84.immediately	38.medicinally
121.primarily			74.temporarily	
104.abnormally				
101.mainly				
99.generally				
98.slightly				
94.typically				
86.normally				
83.(especially				
83.excessively				
82.commonly				
80.fully				
79.collectively				
79.finally				
72.likely				
71.(usually				

Figure 33 the “ly” adverbs sorted by category and frequency.

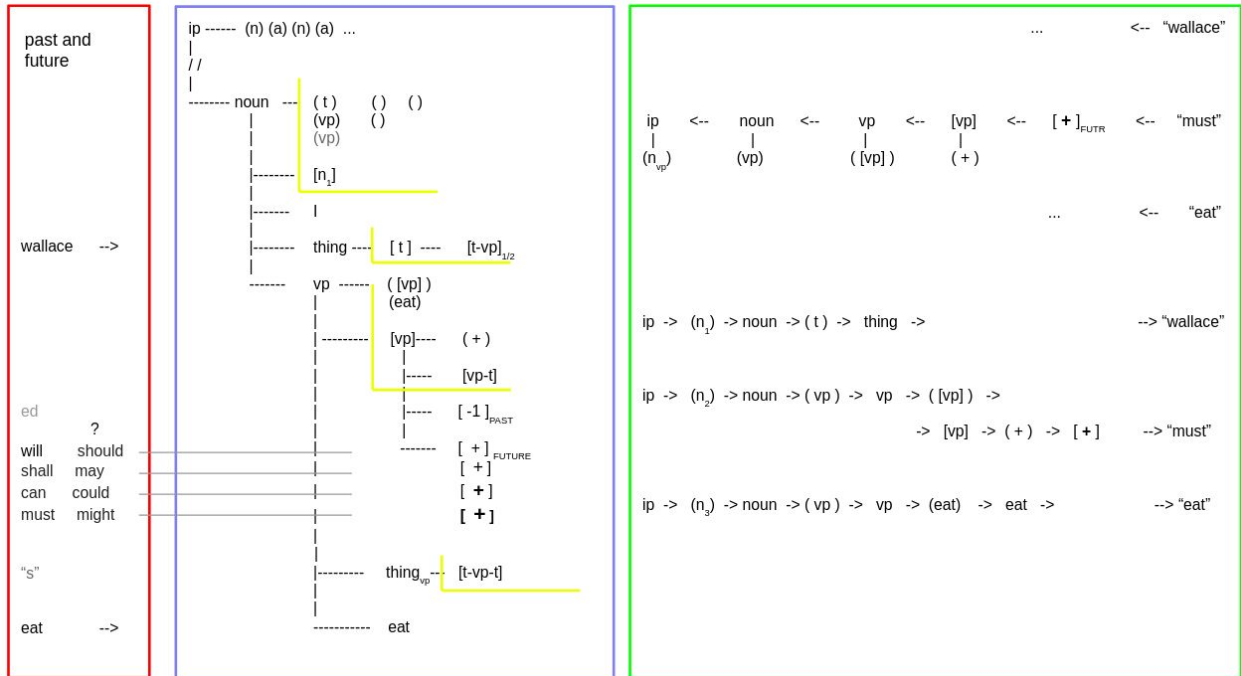

Figure 36 the future modal verbs bifurcate from the vp frame node using the stored value. The future modal (uncertain) verb forms can be alternatively externalized if ip.value = 0

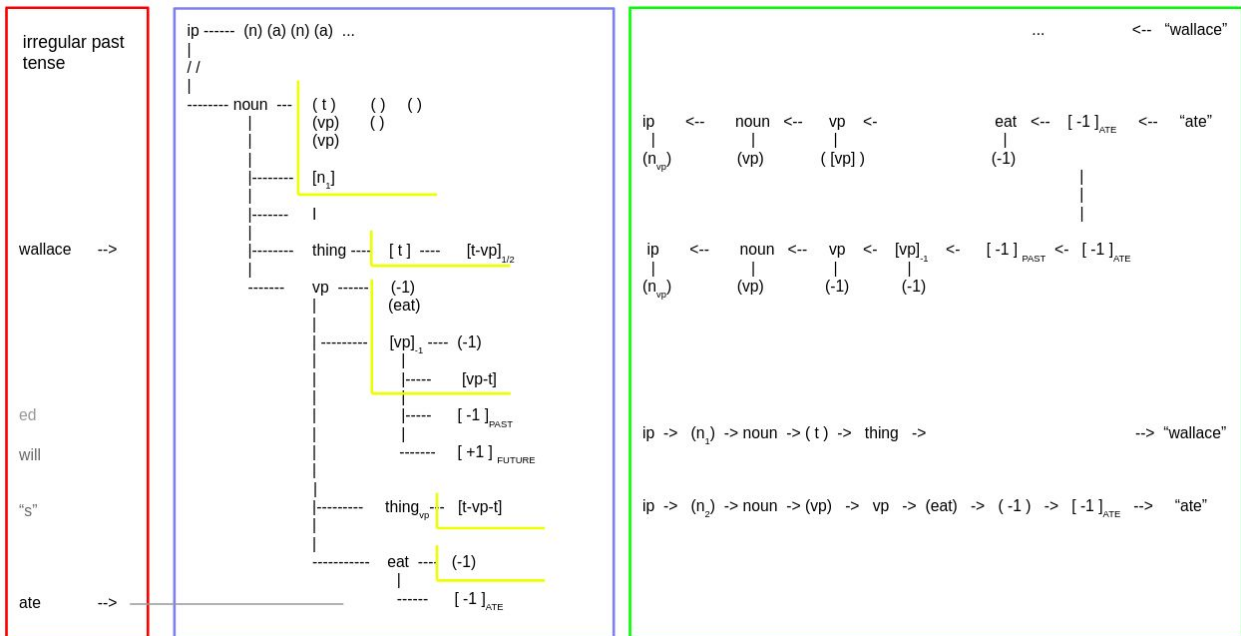

Figure 37 irregular past tense verbs occur as a conditional branch from the verb node based on a stored value of -1. The irregular verb forms allow the same amount of information to be transferred to the listener with one less cycle of the ip graph.

Progressive and Perfected

unfinished and finished

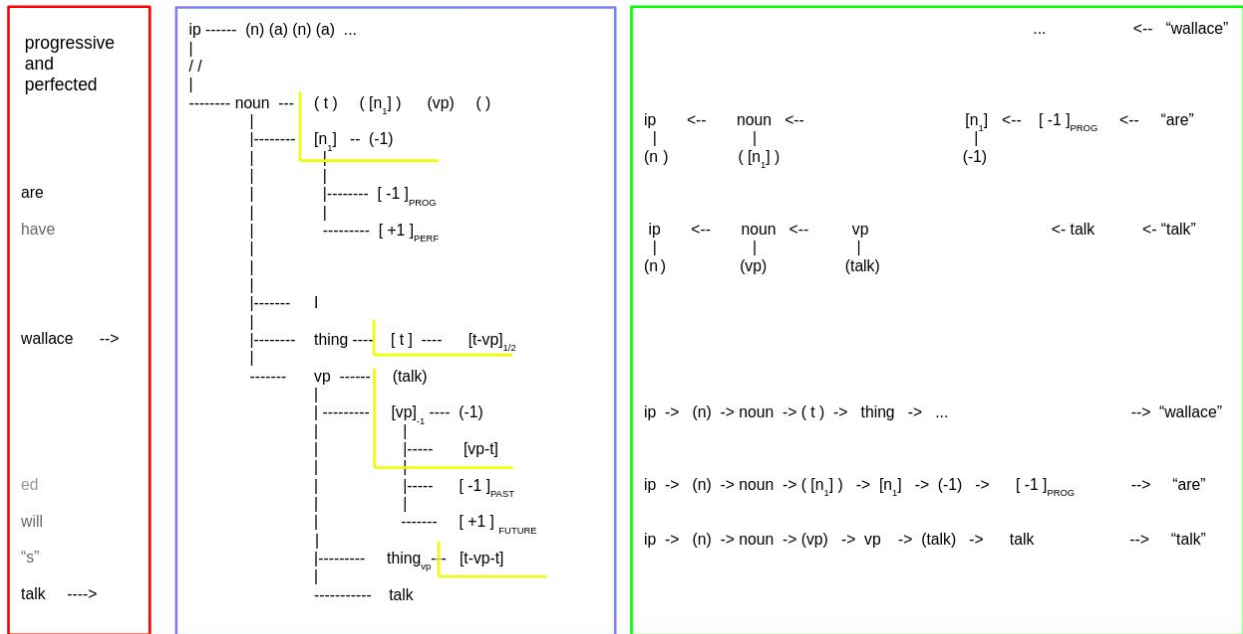

Figure 38

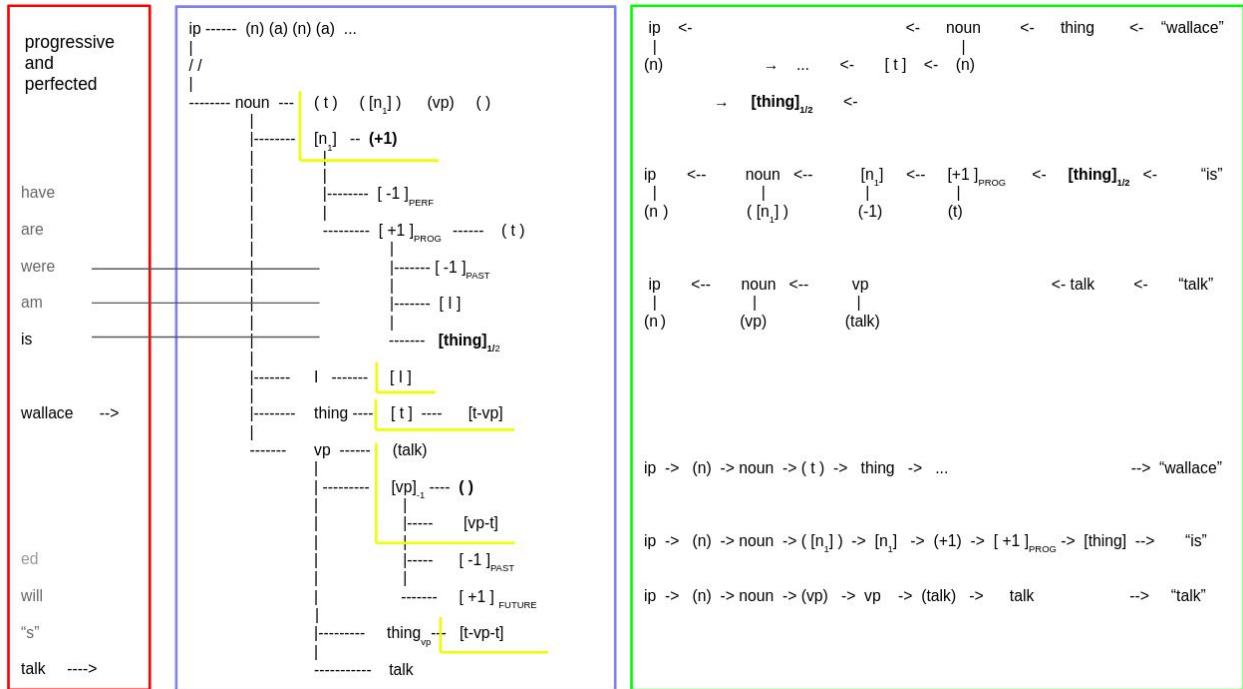

Figure 39 The $[+1]_{\text{PROG}}$ node bifurcates on past, I and thing. The preactivation of the $[\text{thing}]_{1/2} \rightarrow [+1]_{\text{PROG}}$ node allows an error check, ex: wallace *are talk ing. This implies that the information to generate the false * signal is stored in the $[+1]_{\text{PROG}}$ node.

wallace has talk ed

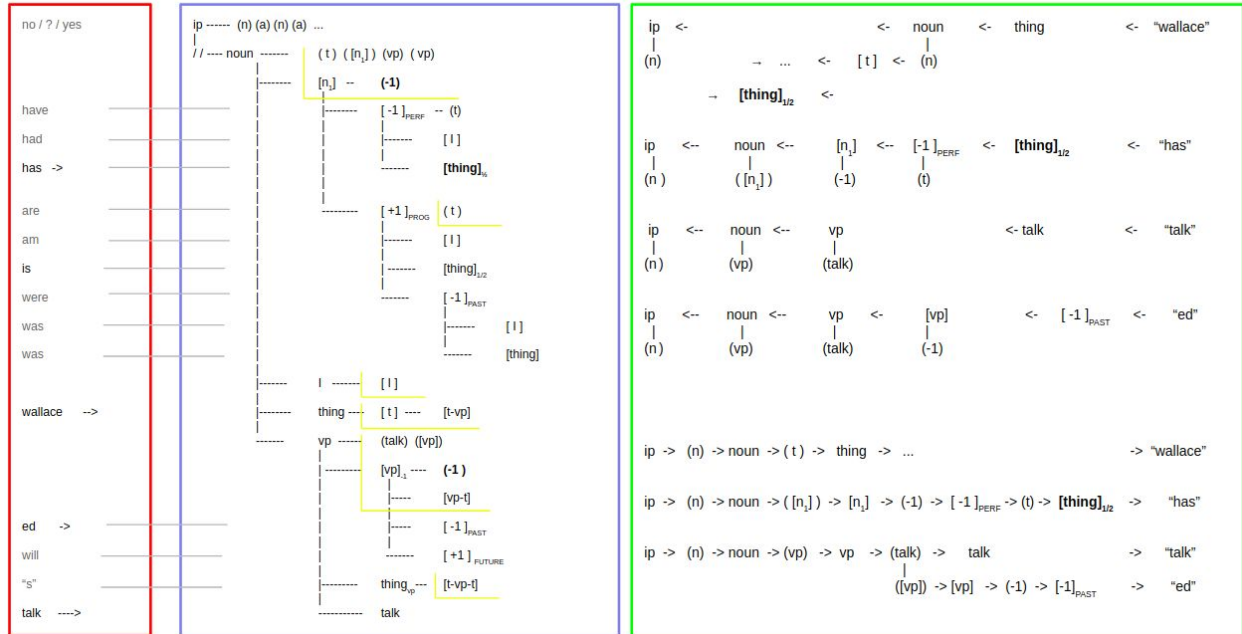

Figure 40

Summary

A symbol is defined to carry a name and a signed value, with value being possibly zero or unspecified.

A symbol's value is analogous to the spiking rate of a neuron, with the sign being analogous to the relative phase of the spiking signal.

Symbols are assumed to be neurological attractor states formed in an "interface parcel".

All of our physical senses are assumed to be represented at the interface parcel as symbols that carry name and intensity (value).

The temporal sequence of all symbols that fire in the interface parcel, stimulated either internally or externally, is analogous to our stream of consciousness.

Computationally, the interface parcel symbols are implemented as hyponym (child) nodes of a single hypernym (head) node labeled "ip".

A short term memory model is proposed that operates via a merge operation between the hypernym and hyponym nodes in the ip graph.

The proposed stm merge operation can be applied to other recently created stm nodes to form short term associations between symbols that have recently fired.

A long term memory mechanism is proposed that operates via a reverse merge operation with the head and copy nodes swapped, but with the original copy node's label retained in the newly created [ltm] node.

Long term memory structures are formed in the same manner as (stm) structures. These ltm structures can be recalled to re-fire the symbols (in sequential order) in the interface parcel.

A single symbol dialogue system is assumed using a corpus of basic adverbs, nouns, verbs, and prepositions.

The ip-graph and short term memory mechanism allow for storage and recall of recently acquired information and for simple dialogue sequences to occur.

Questions and commands are implemented by calling the touch(value) function from main() with value = 0, 1.

The ip node takes on the externalizations [no, ?, yes] corresponding to ip.value = [-1, 0, 1] .

Oscillation of the ip graph allows any combination of two nodes to be associated together in short term memory.

A graph node labeled “a”, is manually added to the ip graph, which allows the adverb-like nodes to replicate as new child nodes through the merge process.

A graph node labeled “n” is added to the ip graph and the non adverb symbols form child nodes as before.

At the simplest, a single oscillation of this graph can bind values stored in the a-branch to the last fired symbol in the n graph.

This a-n graph structure allows a periodic (a-n) number line structure to form.

Oscillation of the a-n graph is hypothesized to produce adverb periodicity in spoken languages.

The simple not dialogue sequences (“not me”, “not now”, etc) are generated by oscillation of the a-n graph. The value is posited to pass between nodes during graph flow and to change at the “me” node, causing subsequent externalization.

A conjunction node is added to the ip graph at the first level and operates in a-n (stm) memory as a new symbol type.

A diff() function can be done at stm merge time to generate a (greater than/less than) return value to the interface parcel.

The direct object node, labeled vp, is added to the noun branch and causes an extra ip-graph cycle to run that sets a n-n sequence in ip-(stm) memory.

The verbs and prepositions will form as child nodes to this vp node and use the double ip-cycle mechanism.

A preposition node is posited to develop as a branch of the vp node that could function to bind the stored adverb values associated with the object to the subject.

The hypernym verb forms [get, do, go, feel/of] are posited to form as child nodes of the vp node.

Adjectives can be output in correct order (per current usage) via graph oscillation. Adverb periodicity does not occur in the adjective sequence.

A thing node is posited to form as a child node to the vp node and to implement the third person present verb ending “-s”.

The simple past tense is posited to occur as a bifurcation of the vp frame node based on the stored value in the frame node.

Irregular past tense verb forms occur as a bifurcation of the verb node based on the stored value.

The future tense is posited to occur as a similar bifurcation on the vp frame node value, but on the opposite sign.

The future modal verbs form a hierarchy based on the stored value of the vp frame node. The question forms of the modal verbs could be generated based on the value of some other graph node, possibly the ip node.

The progressive and perfected nodes are posited to develop as a bifurcation (on value) of the first frame node in the noun subgraph.

The current English grammar develops from these two nodes. The progressive node bifurcates on past, me, and thing. Progressive-past bifurcates on me and thing and perfected bifurcates on me and thing.

references

[1a] tattersall

A tentative framework for the acquisition of language and modern human cognition Ian Tattersall American Museum of Natural History, New York, NY 10024, USA e-mail: iant@amnh.org

[2a] Huth et al, 2016 [A Continuous Semantic Space Describes the Representation of Thousands of Object and Action Categories across the Human Brain Alexander G. Huth,1 Shinji Nishimoto,1 An T. Vu,2 and Jack L. Gallant1,2,3, *]

[2] Huth 2013 et al (+ earlier cited study)

[2b] Deep Hierarchies in the Primate Visual Cortex: What Can We Learn for Computer Vision? Pattern Analysis and Machine Intelligence, IEEE Transactions on (Volume:35 , Issue: 8)

[3] How Could Language Have Evolved? Johan J. Bolhuis, Ian Tattersall, Noam Chomsky, Robert C. Berwick PLOS, August 26, 2014 <http://dx.doi.org/10.1371/journal.pbio.1001934>

[3a] Noam Chomsky's lecture at Harvard. Navigating a Multispecies World: A Graduate Student Conference on the Species Turn. <https://www.youtube.com/watch?v=TAP0xk-c4mk&t=3049s>

[3b] Chomsky, N. J Psycholinguist Res (2015) 44: 91. <https://doi.org/10.1007/s10936-014-9331-5>
<https://dspace.mit.edu/openaccess-disseminate/1721.1/103525>

[3c] "Language, Creativity, and the Limits of Understanding" by Professor Noam Chomsky (4-21-16)
<https://www.youtube.com/watch?v=XNSxj0TVeJs>

[3d] Language and the Cognitive Science Revolution(s), Noam Chomsky, lecture given at Carleton University 2011 <https://chomsky.info/20110408/>

[4] Pinker, words and rules

[5] Evolution, brain, and the nature of language, Berwick et al

[5b] Linear Order and Constituency, Colin Phillips
http://www.colinphillips.net/wp-content/uploads/2014/08/phillips2003_constituency.pdf

[5c] <http://ling.umd.edu/assets/publications/PhillipsLewis-12-DerivationalOrderInSyntax.pdf>

[5d] [https://en.wikipedia.org/wiki/Ellipsis_\(linguistics\)](https://en.wikipedia.org/wiki/Ellipsis_(linguistics))

[6] <http://ase.tufts.edu/cogstud/jackendoff/papers/humanlanguage.pdf>

[7] Empirical approaches to the study of language evolution, Fitch
<https://link.springer.com/article/10.3758/s13423-017-1236-5>

[8] A Framework for Representing Knowledge, Marvin Minsky, MIT-AI Laboratory Memo 306, June, 1974.
<http://web.media.mit.edu/~minsky/papers/Frames/frames.html>

[9] Eye Brain and Vision, David Hubel 1980, <http://hubel.med.harvard.edu/index.html>

[9a] Hubel, D. H., 1957 *Tungsten Microelectrode for Recording from Single Units*

[9b] Hubel, D. H., Wiesel, T. N., 1959 *Receptive fields of single neurones in the cat's striate cortex*

[10] The Meanings of Chimpanzee Gestures, Catherine Hlobaiter and Richard W. Byrne, School of Psychology & Neuroscience, University of St Andrews, St Andrews KY16 9JP, Scotland, UK [http://www.cell.com/current-biology/pdf/S0960-9822\(14\)00667-8.pdf](http://www.cell.com/current-biology/pdf/S0960-9822(14)00667-8.pdf)

[10a] Ape Gestures: Interpreting Chimpanzee and Bonobo Minds | [Richard Moore](#)
Cell Press. [Volume 24, Issue 14](#), 21 July 2014, Pages R645-R647

[10b] Great ape gestures: intentional communication with a rich set of innate signals R. W. Byrne, E. Cartmill, E. Genty K. E. Graham C. Hlobaiter J. Tanner Anim Cogn DOI 10.1007/s10071-017-1096-4

[11] <https://en.wikipedia.org/wiki/Pro-form>

[13] Building Brains to Understand the World's Data, Jeff Hawkins. GoogleTechTalks
<https://www.youtube.com/watch?v=4y43qwS8fI4>

[14] On Intelligence, Jeff Hawkins, 2005

[15] Measuring and Simulating Cellular Switching System IP Traffic. Del Signore, K. W. (2014), Bell Labs Tech. J., 18: 159–180. doi:10.1002/bltj.21651 <http://onlinelibrary.wiley.com/doi/10.1002/bltj.21651/abstract>

[16] <http://grammar.ccc.commnet.edu/grammar/adjectives.htm#order>

[17] Kurzweil how to build a brain

[18] surfaces and essences

[19] Goertzel google tech talk: <https://www.youtube.com/watch?v=A-dycsiRwB4>

[20] code development notes [bica code](#)

Appendix A: Pareto Analysis of the WordNet Corpus

The WordNet corpus is used as input. The corpus consists of definitions for approximately 120K English words. Approximately 60K of the definitions include an additional glossary sentence, with common words having multiple glossary entries. The definitions and glossary sentences were written over a 15 year period by Miller and others [ref], and cover a wide range of human experiences and associated utterances.

```
the children were playing house
the children were playing with lead soldiers
the children were told to stay within earshot
the children were told to put away their toys
the children were left to their own devices
the children were well shoed
the children were confirmed in their mother's faith
the children were found safe and sound
the children were arguing hotly

the children of psychologists are often raised in an atmosphere of experimentalism
the children of Israel

the children had to be in bed before it was time for the trimming of the
the children lined up for a coast down the snowy slope
the children explored each other's bodies by playing the game of doctor
```

Figure a1:

Pareto of noun subjects from the glossary sentences (excluding pronouns).

77. children	25. horse
66. child	24. great
58. car	24. doctor
52. man	23. dog
47. company	23. whole
42. teacher	23. play
40. sun	22. team
39. ship	21. film
39. house	21. baby
34. police	20. dress
34. book	20. crowd
33. students	19. President
32. government	19. sound
30. news	19. building
29. room	19. body
28. water	19. general
27. patient	18. stock
27. plane	18. ball
26. river	18. president
26. road	17. men
25. horse	17. person

Figure a2: also see "ASL: The First 100 Words",
<http://lifefprint.com/asl101/pages-layout/concepts.htm>

Pareto of words in the corpus:

I/O
 76862.a
 75044.the
 70819.of
 42996.to
 35374.or
 31339.in
 26971.and
 24241.is
 14529.an
 13799.that
 13296.with
 11308.by
 10999.for
 7388.on
 6766.from
 6671.as
 5969.who
 5803.having
 4783.used
 4346.was
 3947.he
 3841.his

Figure a3:

- combine [a, the, an, An, etc] into a single node labeled (a:the) -- this node corresponds to the frame [1].

Pareto of all words that precede the (a:the) node. Common prepositions occur most frequently and then as we scan downward, the list becomes almost all verbs.

152550.(a:the)_rev		235.all		81.forms	v
52059.is	v	228.about	p	78.holds	v
21798.of	p	213.where	pro	78.makes	v
11306.in	p	210.off	p	76.lacking	v
5815.to	p	208.along	p	74.got	v
4168.with	p	191.toward	p	73.gave	v
3750.on	p	191.against	p	70.showing	v
3267.by	p	188.within	p	70.hit	v
2788.as	mixed	184.form	v	68.plays	v
2587.from	p	183.out	p	68.determine	v
2348.for	p	172.across	p	67.constituting	v
1784.having	v	171.above	p	67.among	p
1761.at	p	166.before	p	67.inside	p
1579.and	conj	164.containing	v	66.produce	v
1289.into	p	161.without	p	65.provides	v
998.which	pro	151.down	p	65.such	v
766.or	conj	149.made	v	65.became	v
766.was	v	141.give	v	64.beyond	p
499.through	p	139.considered	v	64.led	v
473.between	p	135.below	p	64.contains	v
468.make	v	133.especially	p	62.uses	v
452.has	v	123.not	v	62.but	con:
451.that	pro	122.forming	v	61.including	v
436.over	p	115.resembles	v	61.get	v
401.like	v	114.being	v	60.defeated	v
400.resembling	v	110.take	v	60.produces	v
380.during	p	109.only	v	59.comprising	v
378.after	p	107.using	v	59.cause	v
326.around	p	105.took	v	59.bearing	v
288.when	pro	101.remove	v	59.perform	v
286.under	p	89.making	v	57.until	p
282.than	v	87.are	v	57.throughout	p
272.had	v	84.involving	v	57.behind	p
270.up	p	84.outside	p	56.him	pro
261.have	v	83.formerly	v	56.following	v
251.be	v	83.put	v	54.yielding	v
237.near	p	82.onto	p	53.indicating	v
		81.studies	v	53.indicate	v

Figure a4:

-extract verbs by hand and sort them into categories:

verb pareto from WordNet glossary sentences sorted into 5 categories

get	feel	point	line
111. gave 108. took 87. got 86. made 37. wanted 35. bought 50. put 28. lost 24. found 24. kept	62. felt 44. played 43. worked 37. wanted 19. works 24. lived 24. said 26. sat 25. asked 22. called 22. talked of: 49. spoke 29. heard 27. wrote 18. thought	58. tried 45. used 34. acted 20. threw 19. drew 18. served 18. broke 18. wore 16. passed 14. hit 14. managed 13. started 13. pulled 13. carried 12. set 12. plays 12. changed 12. treated 12. performed 12. traveled 11. began 10. applied 10. claimed 10. suffered	59. looked 26. walked 58. went 26. came 24. left 21. moved 26. ran

Figure a5:

“think of” verbs:

I think of it
I *get of it

There are a limited number of these feel-verbs that can be used with “of” as above. These appear to correspond to a symbol firing in the interface parcel.

feel of it
want of it
speak of it
ask of it
hear of it
write of it
think of it

Major thematic relations

Agent	deliberately performs the action	Bill ate soup	(noun) = (person)
Force or Natural Cause	mindlessly performs the action	An avalanche destroyed the temple. The tornado destroyed the barn.	(noun) = (thing)
Cause	what caused the action to occur	The man cut the grass	(noun) = (person)
Experiencer	the entity that receives sensory or emotional input	Susan heard the song. I cried.	[n v] = [(person) feel-verb]
Stimulus	Entity that prompts sensory or emotional feeling - not deliberately	Kim detests sprouts	[v n] = [feel-verb (noun)]
Theme	undergoes the action but does not change its state	We believe in one God. I have two children. I put the book on the table. He gave the gun to the police officer	(object) + no new stm bindings
Patient	undergoes the action and changes its state	The falling rocks crushed the car	(object) + new stm bindings
Instrument	used to carry out the action	Jamie cut the ribbon with scissors.	[with]
Location	where the action occurs	Johnny played in the park. I'll be studying at Julie's house.	at in on + (place)
Goal : (e.g.,).	where the action is directed towards	The caravan moved to the oasis. He walked to school	Direction - line
Recipient	a special kind of goal associated with verbs	I sent John the letter. He gave the book to her.	get + double objects stm binding changes between object

	expressing a change in ownership, possession		
Beneficiary	the entity for whose benefit the action occurs	I baked Reggie a cake. He built a car for me.	[verb object ₁ object ₂]
The Source or The Origin	where the action originated	The rocket was launched from Central Command. She walked away from him	adverb space
Time	the time at which the action occurs	The rocket was launched yesterday	adverb time
Manner	the way in which an action is carried out	urgently he called 911	adverb -ly
Purpose	the reason for which an action is performed	Tabitha called to get help.	