

Beyond Nominative: A broader view of A'-dependencies in Tagalog

Henrison Hsieh

Department of Linguistics
McGill University
Montréal, Québec, Canada

Initial Submission: June 2020
Final Submission: September 2020

A thesis submitted to McGill University
in partial fulfillment of the requirements
of the degree of Doctor of Philosophy

©Henrison Hsieh 2020

Abstract

This thesis investigates A'-dependency constructions in Tagalog and their interactions with the Philippine-type voice and subject/pivot-marking system, a central topic in research on the syntax of this language. Prominently, Tagalog is known to restrict the formation of such constructions, such that only the syntactically privileged subject/pivot argument of a clause, as determined by the voice form of the verb, may serve as a valid target for the dependency. Much existing work on Tagalog clause structure thus devotes some attention to the derivation of this restriction. However, it is less commonly discussed that instances of A'-dependencies in Tagalog exist that do not conform in some way to this extraction restriction. These can be divided by the nature of the target into two classes, each raising a major question about the syntax of Tagalog that has not been adequately addressed in the literature. First are dependencies that target PPs and other non-DP dependents of a clause. These may consistently be targeted to form A'-dependencies, regardless of the voice form of the verb and the presence of a distinct subject/pivot. However, such exceptional behavior is in some sense independent of the restriction, as non-DP A'-dependencies are formed using structures that are not available to the restriction-conforming dependencies. Consequently, we can ask how this structural asymmetry between DP and non-DP A'-dependencies is derived. Second are dependencies that target non-subject/non-pivot DP dependents of a clause, which represent clear exceptions to the restriction, as they are structurally parallel to the restriction-conforming cases, but nevertheless target a non-subject/non-pivot argument unexpectedly. Crucially, these exceptions exhibit a distribution that is sensitive to structural factors such as clause type and the internal/external argument distinction. Here, we can ask what explains the distribution of these restriction-violating cases.

The main contribution of this thesis is thus to bring attention to this broader range of A'-dependency phenomena and the questions they raise, and consider their implications for the syntax of Tagalog. To the latter end, this thesis proposes that DPs and non-DPs in Tagalog show a difference in movement possibilities stemming from Case. Concretely, it is proposed that movement of DPs in this language is highly restricted due to a locality restriction on abstract Case licensing, so that if a DP moves, it must move to a(nother) position where Case is assigned, otherwise it will not have an interpretable Case value. A result of this is that Tagalog cannot form A'-dependencies of DPs via movement to a left peripheral position in the conventional sense, as such positions are not typically Case positions. Instead, a non-movement analysis is put forth for the formation of such dependencies, whereby a null pronoun, *pro*, introduces a semantic variable that is bound higher in the structure, subject to certain locality constraints. It is shown that this non-movement approach not only derives the DP A'-dependency cases that conform to the well-known restriction in Tagalog, but also helps us understand the DP dependencies that violate it. Specifically, the distribution of *pro* in such instances is argued to be linked to a handful of independently available syntactic operations and environments that allow the aforementioned locality constraints to be satisfied. On the other hand, it is proposed that non-DPs are able to undergo movement more freely because they do not require Case, and therefore that the difference in freedom of movement derives a prominent and consistent structural asymmetry between DP and non-DP A'-dependencies.

Abrégé

Cette thèse investigate les structures à dépendance A' en tagalog, ainsi que leurs interactions avec le système de voix de type philippin, un thème central dans la recherche sur la syntaxe de cette langue. Il est reconnu que le tagalog restreint ces structures, de sorte que c'est uniquement l'élément syntaxiquement privilégié de la proposition (le sujet), tel que déterminé par la voix du verbe, qui puisse servir de cible pour les dépendances. Beaucoup de travail sur la structure propositionnelle du tagalog s'applique donc à expliquer cette restriction. Cependant, on discute moins souvent du fait qu'il existe en tagalog des cas où les dépendances A' ne se conforment pas à cette restriction. Ces cas-là constituent deux classes, distinguées par la nature de la cible ; chacune avance une question majeure sur la syntaxe du tagalog n'ayant jusqu'ici pas été adressée de façon adéquate. En premier lieu, il existe des dépendances qui ciblent des PP et d'autres dépendants non-DP. Ces éléments-là peuvent toujours former une dépendance A' , sans égard à la voix du verbe ou la présence d'un sujet distinct. Pourtant, ce patron exceptionnel constitue en quelque sorte un phénomène indépendant, puisque les dépendances A' des non-DP se forment à partir d'une structure qui n'est pas disponible aux dépendances qui se conforment à la restriction. Par conséquent, nous pouvons demander d'où provient cette asymétrie structurelle entre les dépendances A' des DP et des non-DP. En second lieu, il existe des dépendances ciblant des dépendants de la proposition qui sont des DP mais pas le sujet. Ces dépendances-ci représentent une claire exception à la restriction : leur structure est parallèle aux cas conformes à la restriction, mais, contre toute attente, c'est un argument non-sujet qu'elles ciblent. Il est important de noter que la distribution de ces exceptions est sensible à des facteurs structurels tels que le type de proposition et la distinction entre les arguments internes et externes. Ici, nous pouvons demander qu'est-ce qui explique la distribution de ces cas non-conformes à la restriction.

La contribution principale de cette thèse est donc d'attirer l'attention sur cette plus large gamme de phénomènes A' et sur les questions qui s'ensuivent, et de considérer leurs conséquences pour la syntaxe du tagalog. À cette fin, cette thèse propose que les DP et les non-DP en tagalog démontrent des possibilités de déplacement différentes l'une de l'autre en raison du Cas. Concrètement, il est proposé que le déplacement des DP dans cette langue est grandement restreint à cause d'une restriction de localité sur la licenciement par Cas, de sorte que si le DP se déplace, il doit se déplacer à une (autre) position où un Cas est assigné ; sinon, son Cas sera non-interprétable. Ceci a pour conséquence que le tagalog ne peut pas former de dépendance A' d'un DP en le déplaçant dans une position de la périphérie de gauche conventionnelle, puisque ces positions-là n'assignent normalement pas de Cas. Ainsi, il est suggéré que le déplacement n'est pas en jeu dans la création de ces dépendances en tagalog. Au lieu, un pronom nul, *pro*, qui est assujéti à certaines contraintes de localité, introduit une variable sémantique qui se fait lier plus haut dans la structure. Il est démontré que cette approche sans déplacement peut non seulement expliquer les cas de base des dépendances A' conformes à la restriction bien connue du tagalog, mais aussi aider à comprendre les dépendances non-conformes. Spécifiquement, la distribution de *pro* dans ces cas-là est liée à un nombre d'opérations syntaxiques indépendamment disponibles, ainsi qu'aux environnements pouvant combler la restriction de localité susmentionnée. D'autre part, il est proposé que les non-DP sont capables de se déplacer plus librement car ils n'ont pas besoin de Cas, ce qui crée une asymétrie structurelle proéminente et régulière entre les dépendances A' des DP et des non-DP.

Acknowledgments

If there is one thing that I have really learned in going through the process of graduate school, it is that we are nothing without the people around us. My instinct when faced with a problem has always been to hole up and try to figure it out by myself, and this is something that I have had to unlearn over the course of my time at McGill. That part is still a work in progress, but thankfully, this thesis is drawing to a close. To that end, there are a number of people I would like to express my gratitude to for their part in helping me grow as a linguist and a person.

First and foremost, I would like to thank my co-supervisors, Lisa Travis and Junko Shimoyama, although it is hard to know where to start. From the first summer that she and Michael Wagner sent me to the Philippines to run experiments (before I even officially started at McGill!), to the final stretches of writing this thesis, Lisa has been there through every step of my graduate student career, and I consider myself lucky to have benefited from her guidance, mentorship, generosity, and kindness. I owe much of the material presented in this thesis to her openness to ideas (while still providing constructive pushback) and her uncanny ability to draw insights from her knowledge of Austronesian. If I have not gotten sick of Tagalog, it is because of her enthusiasm. Thank you for pushing me to dream big, even though I may occasionally have a hard time with that.

Junko's support and guidance has been indispensable throughout this process, even though (or perhaps because) Austronesian is not her area of expertise. Beyond her input on the contents of the thesis, Junko impressed upon me the importance of going about my work with intention, from meeting with supervisors to writing my thesis. During the many times when I felt like my progress was stalling, Junko also helped me pay attention on what truly mattered to the task at hand, instead of focusing on the many other details that more often than not lead to deeper and deeper rabbit holes. In many ways, I probably would not have managed to finish this thesis without her.

Last on my committee, but certainly not least, my sincere gratitude goes to Jessica Coon. On paper, Jessica's involvement in the thesis was more limited than Lisa's and Junko's, yet her impact on this work has been anything but. Her comments on earlier drafts of the thesis pushed me to question and refine my assumptions, particularly with regards to Case. The process was not easy, but her advice and guidance helped develop this work from one that I was fine with to one that I was confident in and excited about.

This thesis also could not have been completed without the help of my consultants, both formal and informal. To my Montréal consultants, Zharmaine Ante, Ai Katagiri, and Charm Lising, thank you for your dedication and insightful comments on Tagalog sentences that sometimes make me doubt my

own proficiency. Thank you also to my friends in and from Manila, who have endured randomly timed judgment tasks, often when I'm panicking about something I'm writing.

I would like to thank the people at McGill Linguistics for fostering a community of collaborative learning and growth. In particular, I would like to thank Luis Alonso-Ovalle and Bernhard Schwarz, who supervised my first evaluation paper, which spun off into a research project (with Luis) that has been both challenging and enriching, and spawned numerous talks and a journal submission. I am also grateful to Michael Wagner, who, along with Lisa (as mentioned above), allowed me to dive in head-first into my own thread of research by running an experiment in the Philippines the summer before I officially started. Through this project, I learned how to work with the kind of data that is often needed in asking more fine grained questions, and I thank Michael as well as Morgan Sonderegger for their guidance and advice on the handful of class papers and conference presentations that arose from this project. Among the postdoctoral fellows that have come to McGill during my stay, this thesis also owes an entire branch of inquiry to Nico Baier. We did not meet much to discuss linguistics while he was at McGill (as I have learned, I am not very good at initiating such conversations), but in one such meeting, he (perhaps unknowingly) changed the course of my dissertation by asking out of curiosity about non-DP relative clauses.

To my cohort members, Donghyun Kim, Yuliya Manyakina, Liz Smeets, Jiajia Su, and James Tanner, thank you for making grad school bearable, especially during our first year. Collectively losing our minds over assignments was definitely better than going at it alone. It has been a bit of a strange experience seeing people leave one by one, as we all finished at very different times, but I guess me being the last to arrive in Montréal was an omen of when I'd finish in relation to everyone else. Other grad students over the years have also enriched my time at McGill with stimulating conversation about linguistics and beyond, as well as other kinds of non-linguistics fun (board game nights, road trips, parties, and just hanging out and being silly). In particular, I would like to thank: Oriana Kilbourn-Ceron and Sepideh Mortazavinia (and Liz) for being the silliest officemates; Brian Buccola and Dan Goodhue for the semantics talks and the board game nights; Hye-young Bang, Gouming Martens, Yeongwoo Park, Jiaer Tao (and Donghyun) for all the food, random drop-ins, and study sessions; and Mathieu Paillé for our conversations on Austronesian and Welsh (unfortunately separately). Thanks also to Mathieu and to Jeff Lamontagne for helping with French translation of my abstract.

Special thanks also to our support staff, Andria De Luca and Giuliana Panetta, as well as (for a short period) Rebecca Pothier and Leeza Girolami. You keep the department running like a well-oiled machine; I hope I didn't cause too many headaches!

To my fellow Austronesianists, especially my fellow junior Tagalog researchers, thank you for being my second community that I can turn to for advice and engaging discussion. I have learned and benefited much from discussions with Maayan Abenina-Adar, Edith Aldridge, Mitcho Erlewine, Dan Kaufman, Yining Nie, Jed Pizarro-Guevara, Norvin Richards, and Nozomi Tanaka.

I also thank my friends from the McGill Knitting Club, Espace Tricot, and the Montréal Men's Knitting Group for providing welcoming communities and making Montréal seem a little bit more like home. In particular, I am indebted to the moral support offered by my friends Sarah Ingold, June Lee, and Kate Woo. Many thanks also to Phil Joudrey, whose community-building spirit and constructive

encouragement regarding my thesis have been a much needed balm these past six or seven months.

Finally, to my family, especially to my parents. Thank you for pushing me to pursue higher education abroad, despite the great emotional and financial cost. In many ways, going to school in a different country played a big part in where I am today, although I suspect that pursuing a doctorate was much more than you initially bargained for.

The final version of this thesis benefitted from comments from Martina Martinović, Joey Sabbagh, as well as Richard Compton. This research was funded by a McGill Arts Graduate Student Travel award and a Social Sciences and Humanities Research Council of Canada (SSHRC) grant to Lisa Travis, in addition to the funding package offered by the McGill Department of Linguistics.

Contents

Abstract	ii
Abrégé	iii
Acknowledgments	iv
Contents	xi
List of Tables	xii
Abbreviations	xiii
Some notes on orthography and glossing	xiv
1 Introduction	1
1.1 The empirical landscape	3
1.1.1 Non-pivot dependencies	4
1.1.2 Non-DP dependencies	6
1.2 Main claims and motivation	8
1.3 Thesis overview	10
2 Tagalog Background	12
2.1 Preliminaries	13
2.2 Word order	13
2.3 Aspect	15
2.3.1 On the recent perfective	18
2.4 Dependent marking	19
2.4.1 Surface realization of nominal marking	19

2.4.2	Categorial status	21
2.4.3	Underlying patterns	27
2.5	Summary	30
3	On the status of <i>ang</i>	31
3.1	Voice and nominative	32
3.1.1	The morphology of the voice system	34
3.1.2	Agr ⁰ as the locus of nominative	39
3.2	<i>Ang</i> as Case	44
3.3	Peripheral arguments and applicatives	52
3.3.1	Two underlying structures	52
3.3.2	Applicative structure is deficient	58
3.3.3	Other types of applicatives	61
3.4	Against previous accounts	63
3.4.1	Against <i>ang</i> as “other”	63
3.4.2	Against transitivity alternations	68
3.4.3	Against default/last-resort case	71
3.5	Agr ⁰ in other clausal constructions	72
3.6	Chapter summary	78
4	Survey of A'-dependencies	80
4.1	Distribution	82
4.1.1	Basic overview	82
4.1.2	Non-overlapping distribution	83
4.2	DP vs non-DP focus structure	87
4.2.1	The particle <i>ang</i> : Subjecthood of presuppositional statement	89
4.2.2	Predicatehood of focus constituent	91
4.2.3	Clitic placement	95
4.2.4	<i>Siyang</i>	96
4.2.5	Weak crossover patterns	97
4.3	DP vs non-DP relative clause structure	99
4.3.1	Otsuka & Tanaka (2016)	99
4.3.2	Word-order differences	101

4.3.3	Headless relatives	103
5	Voice-Agreeing dependencies	106
5.1	Proposal overview	107
5.2	DP focus as pseudoclefts	109
5.2.1	Focus as a copular clause	110
5.2.2	Motivating the base structure	115
5.3	DP relativization with <i>pro</i>	124
5.3.1	Theme relative clauses	125
5.3.2	Agent relative clauses	129
5.4	Long-distance relativization	131
5.4.1	Voice and long-distance dependencies	131
5.4.2	Assumptions for declarative embeddings	135
5.4.3	Long-distance dependencies via <i>pro</i> as a repair	136
5.5	Interim summary and discussion	140
5.6	Comparison to alternatives	142
5.6.1	Long-distance binding	142
5.6.2	Successive-cyclic movement	143
5.6.3	(Putative) Long-distance dependencies through relative clause stacking	148
5.7	Chapter Summary	151
6	Non-agreeing DP Dependencies	153
6.1	Introduction	153
6.2	Genitive inversion	156
6.2.1	Overview	157
6.2.2	Genitive inversion and other fronting constructions	160
6.2.3	Inversion and external arguments	162
6.2.4	The structure of inversion	166
6.2.5	Remaining issues and discussion	170
6.3	Genitive agent dependencies	172
6.3.1	Background and distribution	173
6.3.2	Derivation by <i>pro</i>	176
6.4	Subextraction	181

6.4.1	Background	181
6.4.2	Two distributional properties of subextraction dependencies	184
6.4.3	Background on nominal structure	187
6.4.4	Derivation by <i>pro</i>	190
6.4.5	Advantages over previous analyses	195
6.5	Free dependencies	200
6.5.1	The reduced nature of free dependency environments	202
6.5.2	Dependencies with Recent Perfective	206
6.5.3	Background on (exclamative) adjectives	209
6.5.4	Dependencies with exclamative adjectives	217
6.6	Conclusion and discussion	224
7	Non-DP Dependencies	227
7.1	On the DP/non-DP split	229
7.1.1	Non-DP dependencies are voice-agnostic	229
7.1.2	Non-DP dependencies are structure-agnostic	232
7.1.3	Persistence of the non-DP form	234
7.2	The articulated left periphery	238
7.2.1	Rizzi (1997)	238
7.2.2	On <i>kung</i> and <i>kung+wh</i>	239
7.2.3	A word order puzzle (Sabbagh 2013)	241
7.3	Fronting and constituent order	245
7.3.1	Different distributions	245
7.3.2	Focus and <i>wh</i>	247
7.3.3	Second position clitics	250
7.3.4	<i>Ay</i> -inversion	253
7.3.5	The high position of <i>bakit</i> ‘why’	258
7.3.6	Recent Perfective and the Left Periphery	261
7.4	Non-DP movement & DP non-movement	264
7.4.1	On movement, Case, and the DP/non-DP split	264
7.4.2	On locality	267
7.4.3	An <i>ay</i> -inversion puzzle	268

7.5	Conclusion	271
8	Conclusion	273
8.1	On Case in Tagalog	274
8.2	On non-movement in Tagalog	275
8.3	On true A'-movement in Tagalog	278
8.4	Looking ahead	279
	Bibliography	292

List of Tables

2.1	Aspect paradigm for LV (<i>-an</i>) and AV (<i>mag-</i>) forms of <i>bigay</i> ‘give’	17
2.2	Interactions between voice and aspect (irregular forms highlighted)	17
2.3	Nominal marking paradigm for Tagalog	20
2.4	Underlying dependent marking patterns	28
2.5	Underlying dependent marking patterns with sources	30
3.1	Availability of <i>ang</i> -marking with respect to Aspect and Voice marking	41
3.2	Derivational possibilities with PP- and applicative structures (incomplete)	57
3.3	Derivational possibilities with PP- and applicative structures	60
4.1	Types of A'-dependencies in Tagalog	81
4.2	Structural diagnostics for focus constructions	99
4.3	Structural diagnostics for focus constructions	104
6.1	Distribution of genitive-targeted DP A'-dependencies	155
6.2	Differences between genitive inversion and focus fronting	161
6.3	Summary of possible DP dependencies based on the types of movement	200
6.4	Contrasts between string-identical full DPs and <i>ang</i> -exclamatives	217
7.1	Distribution of <i>kung+wh</i> constructions based on target	246
7.2	Cliticization patterns with non-DP fronting constructions	252
7.3	Word-order patterns with fronting constructions (<i>ay</i> -topics)	258
7.4	Word-order patterns with fronting constructions (<i>bakit</i> questions)	261
7.5	Word-order patterns with fronting constructions	264

Abbreviations

1	First person	LN	Locative nominalization
2	Second person	LV	Locative voice
3	Third person	MED	Medial
ABS	Absolutive	MIR	Mirative particle
ACC	Accusative	NEG	Negative
ADJ	Adjective	NOM	Nominative
ADV	Adverbial	NVOL	Non-volitive form
AN	Agent nominalization	OBL	Oblique
AV	Agent voice	ORD	Ordinal prefix
CAUS	Causative	P	Personal form determiner
CL	Clitic	PFV	Perfective
COM	Comitative	PL	Plural
COMP	Complementizer	PN	Patient nominalization
CV	Circumstantial voice	POL	Politeness particle
DAT	Dative	PRED	Predicative
DEM	Demonstrative	PROX	Proximal
DIST	Distal	PST	Past
EMPH	Emphatic particle	PV	Patient voice
ERG	Ergative	Q	Question particle
EXCL	Exclusive	QUOT	Quotative
EXIS	Existential verb	RED	Reduplicand
FUT	Future	RPFV	Recent perfective
GEN	Genitive	SG	Singular
GER	Gerund	STAT	Stative
IMPF	Imperfective	SUBJ	Subjunctive
INCL	Inclusive	SUPL	Superlative prefix
INS	Instrumental	TOP	Topic
LK	Linker	WH	<i>Wh</i> -expression

Some notes on orthography and glossing

The examples in this thesis follow the conventional writing system of Tagalog, which is mostly phonemic with a few details to be aware of.

First, two function words have standard abbreviated spellings: the *common noun genitive marker* written as ⟨ng⟩ is pronounced /naŋ/; and the *plural morpheme* written as ⟨mga⟩ is pronounced /ma'ŋa/. These are conventionally written as distinct orthographic words, as (1) shows. Elsewhere, the digraph ⟨ng⟩ corresponds to the phoneme /ŋ/, also highlighted in (1).

- (1) Ng<in>i~ngiti-an **ng** **mga** bata=**ng** ma-ta~tangkad **ang** pusa.
 /ŋiniŋiti'ʔan/ /naŋ/ /maŋa/ /'ba:taŋ/ /matataŋ'kad/ /aŋ/ /pusaʔ/
 AV.IMPF~smile-LV GEN PL child=LK ADJ-PL~tall NOM cat

'The tall children are smiling at the cat.'

Second, stress is phonemic, and is marked with diacritics under the prescriptive standard (Komisyon sa Wikang Filipino 2014).¹ However, in everyday usage, these diacritics are almost always left out. In this thesis, they will be used to distinguish potentially ambiguous words or to highlight phenomena that affect stress patterns. The diacritics are shown in (2). An acute accent ⟨á⟩ marks stressed syllables, though stressed penultimate syllables are commonly unmarked. A grave accent ⟨à⟩ marks orthographically final vowels with a following glottal stop. Finally, a circumflex accent ⟨â⟩ marks orthographically final vowels that are *both* stressed and followed by a glottal stop.

- (2) a. ⟨báka⟩ or ⟨baka⟩ /'ba:ka/ 'cow' vs ⟨baká⟩ /ba'ka/ 'maybe'
 b. ⟨pákò⟩ or ⟨pakò⟩ /'pa:koʔ/ 'nail (for building)' vs ⟨pakò⟩ /pa'koʔ/ 'fern'
 c. ⟨túlog⟩ or ⟨tulog⟩ /'tu:log/ 'sleep, to sleep' vs ⟨tulóg⟩ /tu'log/ 'asleep'

Glossing conventions mostly adhere to the Leipzig Glossing Rules, using the abbreviations listed above, and with untranslated words/morphemes italicized. In particular, the tilde (~) indicates a morpheme break involving reduplication (usually a CV-reduplication prefix), and the equal sign (=) indicates a clitic boundary. The latter is used in this thesis primarily with the velar nasal allomorph =ng of the Tagalog linker morpheme, which surfaces when the preceding word ends in a vowel, a glottal stop, or /n/, and is written as a single word with the preceding one under the conventional orthography. Phonologically, final consonants (/n, ʔ/) are deleted before =ng, thus having an orthographic effect on /n/-final words (word-final glottal stops are indicated by diacritics, if at all). In such cases, I indicate the underlying /n/ in square brackets. (3a) shows an example, with a parallel glottal-stop-final word for comparison in (3b).

- (3) a. ⟨kaibígan⟩ /kaʔi'bi:gan/ 'friend' + =ng → kaibíga[n]=ng /kaʔi'bi:gaŋ/
 b. ⟨pákò⟩ /'pa:koʔ/ 'nail (for building)' + =ng → pákò=ng /'pa:koŋ/

¹Note that a major correlate of stress in Tagalog is vowel length, to the extent that there is some debate in the literature as to which of these is the primary phenomenon. See Himmelmann 2005, §2 for discussion and references.

Chapter 1

Introduction

While much is understood about Tagalog descriptively, not much consensus has formed with regards to the formal analysis of the basic aspects of its clause structure in the generative literature. A number of interrelated core issues are still the subject of ongoing debate. These include the case alignment system, the intricate system of verbal morphology usually referred to as (Philippine- or Austronesian-type) “voice”, and the nature of the syntactically privileged “pivot” argument of a clause.¹ These issues are exemplified by the examples in (1), which are minimally different from each other. We see that changes in the form of the verb in each sentence (boldface) correlate with changes in the role of the pivot argument marked with *ang* (underlined).

- (1) a. **Nagsu~sulat** ang estudyante ng tula sa folder.
AV.IMPF~write NOM student GEN poem OBL folder
‘The student is writing a poem on the folder.’ *Nagsusulat* (AV); Agent pivot
- b. **S<in>u~sulat** ng estudyante ang tula sa folder.
IMPF~write[PV] GEN student NOM poem OBL folder
‘The student is writing the poem on the folder.’ *Sinusulat* (PV); Theme pivot
- c. **S<in>u~sulat-an** ng estudyante ng tula ang folder.
IMPF~write-LV GEN student GEN poem NOM folder
‘The student is writing the poem on the folder.’ *Sinusulatan* (LV); Goal pivot

The sentences in (1) show only a sample of the system of alternations in Tagalog that has so far resisted analytical agreement among researchers, even with respect to high-level details. For example, it can be observed that the alternation in (1) is reminiscent of voice alternations (i.e., active-passive, active-antipassive) found in many languages. Some scholars thus take this observation and propose a formal account along these lines. A more recent proposal in this vein is by Aldridge (2004a, 2012), who argues that Tagalog exhibits an ergative-absolutive alignment, so that the *ang*-marked pivot argument is analyzed as the absolutive argument of a clause, and the alternations in clause structure are formally between transitive

¹A number of other terms have been used to refer to the pivot argument in various works, including “subject”, “topic”, and “focus”. The term pivot is used in this thesis to avoid the theoretical associations that accompany the other terms.

active clauses (1b-c) and syntactically intransitive antipassive clauses (1a). This approach is not universally taken, however. For example, a nominative-accusative alignment has been proposed by Guilfoyle et al. (1992), with the *ang*-marked pivot analyzed as the nominative argument of a clause, and alternations characterized as active-passive (i.e., between (1a) and (1b-c)). There are also analyses that reject the voice-based approach, instead proposing that pivot marking and the alternations in verbal morphology are the reflex of a formally distinct mechanism such as an Agree relation with the highest DP in the *vP* domain (Rackowski 2002; Rackowski and Richards 2005) or with a clause-internal topic (Chen 2017). Under these approaches, alternations in transitivity may affect the voice system, but do not fully determine the observed alternations.

A phenomenon at the forefront in this area of research is A'-dependency formation, which displays significant interactions with the voice and pivot system. Specifically, a commonly noted generalization is that processes like relativization, *wh*-question formation, and focalization in Tagalog may only target the pivot argument of a clause (i.e., the one cross-referenced by voice morphology on the verb). For example, with the verb form *nagsusulat* as in (1a), the agent is the pivot and subsequently the argument accessible to relativization, as (2a) shows. In contrast, (2b) shows that with the same verb form, the theme *cannot* be relativized.

(2) RELATIVIZATION WITH *nagsusulat* (cf. 1a)

- a. Naki~kinig sa musika ang estudyante=ng [**nagsu~sulat** ng tula].
 AV.IMPF~listen OBL music NOM student=LK AV.IMPF~write GEN poem
 'The student [who is writing a poem] is listening to music.' ✓Agent (= pivot) relativization
- b. *Ma-haba ang tula=ng [**nagsu~sulat** ang estudyante].
 ADJ-long NOM poem=LK AV.IMPF~write NOM student
 Intended: 'The poem [that the student is writing] is long.' *Theme (= non-pivot) relativization

To relativize the theme, the form *sinusulat* from (1b) must be used, since this is the form associated with a theme pivot. The result is (3a). Furthermore, we see in (3b) that this same verb form is marginally grammatical with agent relativization. This marginal grammaticality is significant in the context of previous work which has taken such examples to be fully ungrammatical, and is introduced more fully later on in this chapter.

(3) RELATIVIZATION WITH *sinusulat*

- a. Ma-haba ang tula=ng [**s<in>u~sulat** ng estudyante].
 ADJ-long NOM poem=LK IMPF~write[PV] GEN student
 'The poem [that the student is writing] is long.' ✓Pivot theme relativization
- b.??Naki~kinig sa musika ang estudyante=ng [**s<in>u~sulat** ang tula].
 AV.IMPF~listen OBL music NOM student=LK IMPF~write[PV] NOM poem
 'The student [who is writing the poem] is listening to music.' ?Non-pivot agent relativization

We find parallel behavior with the form *sinusulatan* in (1c). This verb form allows the goal, which is the pivot, to be relativized, as (4a) shows. Contrast this with the relativization of non-pivots, which is

marginal with agents (4b) and ungrammatical with themes (4c).

(4) RELATIVIZATION WITH *sinusulatan*

- a. Kulay pink ang folder na [**s<in>u~sulat-an** ng estudyante ng tula].
 color pink NOM folder LK IMPF~write-LV GEN student GEN poem
 ‘The folder [that the student is writing a poem on] is pink.’ ✓Pivot goal/receptacle rel.
- b.??Naki~kinig sa musika ang estudyante=ng [**s<in>u~sulat-an** ng tula ang folder].
 AV.IMPF~listen OBL music NOM student=LK IMPF~write[PV] NOM poem
 ‘The student [who is writing a poem on the folder] is listening to music.’ ?Non-pivot agent rel.
- c. *Ma-haba ang tula=ng [**s<in>u~sulat-an** ng estudyante ang folder].
 ADJ-long NOM poem=LK IMPF~write-LV GEN student NOM folder
 Intended: ‘The poem [that the student is writing on the folder] is long.’ *Non-pivot theme rel.

Most analyses of Tagalog clause structure take the pivot-only restriction on A'-dependency formation we have just seen as a major detail to be accounted for. However, there are certain ways in which the generalization about this restriction is too simplistic. Characterizing the restriction as simply “pivot-only” excludes certain attested classes of A'-dependencies, so any analysis that assumes that only pivots may be targeted for A'-dependency formation will necessarily be an inadequate account of the Tagalog facts. While such excluded cases are not unknown in the literature on Tagalog, little attention has been given to them in comparison to the cases that do conform to the pivot-only generalization. The overall goal of this thesis is therefore to investigate a broader range of Tagalog A'-dependency data, including those cases that do not straightforwardly conform to the received pivot-only generalization. Doing so has the benefit not only of addressing the gaps in research on Tagalog A'-dependencies, but also of informing the analysis of the more well-studied phenomena, which have nevertheless eluded strong consensus over the years. To set the stage for the thesis, we begin by considering the pivot-only generalization and the constructions that do or do not conform to it.

1.1 The empirical landscape

To a first approximation, the pivot-only generalization does capture a large portion of the attested behavior for A'-dependencies in Tagalog. We have seen examples in (2-4) showing the relevant behavior for relative clauses. Parallel patterns are also found with *wh*-questions and focus constructions, as (5) and (6) show.

(5) *Wh*-QUESTIONS WITH *nagsusulat*

- a. Sino ang [**nagsu~sulat** ng tula]?
 who.NOM NOM AV.IMPF~write GEN poem
 ‘Who is writing a poem?’ ✓Agent (= pivot) question

b. *Ano ang [**nagsu~sulat** ang estudyante]?
 what[NOM] NOM AV.IMPF~write NOM student

Intended: 'What is the student writing?'

*Theme (= non-pivot) question

(6) FOCUS CONSTRUCTIONS WITH *nagsusulat*

a. Ang pinsan ni Pepe ang [**nagsu~sulat** ng tula].
 NOM cousin GEN.P Pepe NOM AV.IMPF~write GEN poem

'The one writing a poem is Pepe's cousin.'

'It's Pepe's cousin who is writing a poem.'

✓Agent (= pivot) focus

b. *Ang ma-haba=ng tula ang [**nagsu~sulat** ang estudyante].
 NOM ADJ-long=LK poem NOM AV.IMPF~write NOM student

Intended: 'What the student is writing is the long poem.'

'It's the long poem that the student is writing.'

*Theme (= non-pivot) focus

The examples so far show pivots that are valid targets for A' -dependencies, and non-pivots that are invalid targets—examples that conform to the pivot-only restriction. As previously suggested however, this restriction is not exceptionless. Generally, while pivothood is a sufficient condition for A' -dependency formation, it is not strictly necessary. In other words, all pivots are valid A' -dependency targets, but some *non*-pivots are eligible as well. The cases of A' -dependencies that target non-pivot arguments can be divided into two broad classes: those that target non-pivot DPs and those that target non-DPs.

1.1.1 Non-pivot dependencies

The first class may be considered true exceptions to the pivot-only restriction, as these differ minimally from the pivot-targeting constructions in simply targeting non-pivot DP arguments (which are marked *ng*). They are otherwise structurally parallel to the canonically studied pivot-targeting cases. Examples include dependencies that target: non-pivot agents (7); possessors of pivot DPs (8); and arguments of the special recent perfective form (9). In these examples, (a) shows a baseline example with the targeted argument highlighted in bold, while (b) and (c) show relative clauses and *wh*-questions/focus constructions, respectively. Some previous literature that mentions the existence of such constructions is also indicated.

(7) NON-PIVOT AGENTS

(Pizarro-Guevara and Wagers 2018; Tanaka et al. 2016)

a. S<in>u~sulat **ng estudyante** ang tula sa folder.
 IMPF~write[PV] GEN student NOM poem OBL folder

'The student is writing the poem on the folder.'

Baseline; repeated from (1b)

b.??B<in>igy-an ko ng tsaa ang estudyante=ng [s<in>u~sulat ang tula sa folder].
 <PFV>give-LV 1SG.GEN GEN tea NOM student=LK IMPF~write[PV] NOM poem OBL folder

'I gave (some) tea to the student who was writing the poem on the folder.'

Relative clause

- c.?? {Sino /Ang estudyante=*ng* pandak} ang [s<in>u~sulat ang tula sa folder]
 who.NOM NOM student=LK short NOM IMPF~write[PV] NOM poem OBL folder
 ‘Who is writing the poem on the folder?’ *Wh*-question
 ‘It’s the short student who is writing the poem on the folder.’ Focus construction
- (8) POSSESSORS OF PIVOTS (Ceña 1979; Kroeger 1993)
- a. Na-basâ ang diyaryo **ng guro**.
 PFV-wet NOM newspaper GEN teacher
 ‘The teacher’s newspaper got wet.’ Baseline sentence
- b. B<in>igy-an ko ng tsaa ang guro=*ng* [na-basâ ang diyaryo].
 <PFV>give-LV 1SG.GEN GEN tea NOM teacher=LK PFV-wet NOM newspaper
 ‘I gave (some) tea to the teacher whose newspaper got wet.’ Relative clause
- c. {Sino /Ang guro ko } ang [na-basâ ang diyaryo].
 who.NOM NOM teacher 1SG.GEN NOM PFV-wet NOM newspaper
 ‘Whose newspaper got wet?’ *Wh*-question
 ‘It was my teacher whose newspaper got wet.’ Focus construction
- (9) RECENT PERFECTIVE (THEME DEPENDENCY) (Kroeger 1993; McGinn 1988; Schachter 1996)
- a. Kabi~bili lang ng mángingisdâ **ng gulay**.
 RPFV~buy only GEN AN.fish GEN vegetable
 ‘The fisherman has just bought vegetables.’ Baseline
- b. Sariwa pa ang gulay na [kabi~bili lang ng mángingisdâ].
 fresh still NOM vegetable LK RPFV~buy only GEN AN.fish
 ‘The vegetables that the fisherman has just bought are still fresh.’ Relative clause
- c. {Ano /Ang sitaw } ang [kabi~bili lang ng mángingisdâ].
 what[NOM] NOM longbean NOM RPFV~buy only GEN AN.fish
 ‘What has the fisherman just bought?’ *Wh*-question
 ‘It’s the longbeans that the fisherman has just bought.’ Focus construction

Aside from the fact that the dependency gap in the preceding examples corresponds to a non-pivot (i.e., marked *ng*) DP, these constructions are structurally identical to their pivot-targeting counterparts. We can see this by comparing (8-9) to the pivot-targeting examples shown previously, repeated in (10) for convenience. We see that in relative clauses, the Tagalog linker morpheme—surfacing as syllabic *na* or its velar nasal allomorph *=ng*—mediates between the relative clause head and the modifier. For *wh*-questions and focus constructions, the determiner *ang* intervenes between the clause-initial *wh*-expression or focus constituent and the presuppositional statement (i.e., the remainder of the clause).

(10) PIVOT-TARGETING DEPENDENCIES (FOR COMPARISON)

- a. Ma-haba ang tula=**ng** [s<in>u~sulat ng estudyante].
 ADJ-long NOM poem=LK IMPF~write[PV] GEN student
 ‘The poem that the student is writing is long.’ Relative clause
- b. {Ano /Ang ma-haba=**ng** tula } **ang** [s<in>u~sulat ng estudyante].
 what[NOM] NOM ADJ-long=LK poem NOM IMPF~write[PV] GEN student
 ‘What is the student writing?’ Wh-question
 ‘It’s the long poem that the student is writing.’ Focus construction

This type of data is thus the clearest counterevidence against a *strictly* pivot-only formalization of the Tagalog A'-dependency formation patterns. Instead, the patterns of acceptability among these exceptional cases suggest structural factors other than pivothood are at play, and should be accounted for in the formulation of the restriction. For example, we have already seen that not all non-pivot DPs are valid A'-dependency targets; non-pivot theme relativization is fully ungrammatical as in (2b) and (4c). Second, some of these examples, particularly those involving non-pivot agent relativization (7), are judged to be less acceptable than pivot-targeting dependencies but more acceptable than the ungrammatical non-pivot theme dependencies that we have seen (see Pizarro-Guevara and Wagers 2018 for experimental confirmation of this difference). A more holistic investigation into the behaviors of this class of constructions is thus necessary to form a better picture of the syntax of A'-dependency formation in Tagalog.

1.1.2 Non-DP dependencies

The second class of exceptions to the pivot-only restriction in Tagalog are the A'-dependencies that target non-DPs. Compared to the non-pivot targeting cases, the status of this class of constructions in relation to the pivot-only restriction is perhaps less clear, as they operate independently of it, in some sense. This behavior is demonstrated in the following examples.

The examples in (11) repeat two regular declarative clauses from (1). The verbs in these clauses have different voice forms (*nagsusulat* vs *sinusulat*), corresponding to different pivots. In both of these examples, the goal PP *sa folder* (boldface) can, in some sense, be targeted for relativization, *wh*-question formation, and focalization despite not being the pivot of the clause. Crucially however, we see in (12-13) that the *form* of these constructions is distinct from the DP-targeting examples we have seen so far. For the PP-targeting relative clauses in (12), we see that instead of the linker, the relative clause head is followed by a complementizer *kung* and an overt *wh*-expression, *saan* ‘where’. Similarly, we see that the PP *wh*-questions and focus constructions in (13) differ from the DP *wh*-question and focus examples in that the determiner *ang* that appears after the *wh*- or focus constituent in the DP-targeting constructions is *ungrammatical* in the PP examples.

- (11) a. Nagsu~sulat ang estudyante ng tula **sa folder**.
 AV.IMPF~write NOM student GEN poem OBL folder
 ‘The student is writing a poem on the folder.’

- b. S<in>u~sulat ng estudyante ang tula sa folder.
 IMPF~write[PV] GEN student NOM poem OBL folder
 ‘The student is writing the poem on the folder.’

(12) PP-TARGETING RELATIVE CLAUSES

- a. Kulay pink ang folder **kung saan** [nagsu~sulat ang estudyante ng tula].
 color pink NOM folder COMP where AV.IMPF~write NOM student GEN poem
 ‘The folder where the student is writing a poem is pink.’
- b. Kulay pink ang folder **kung saan** [s<in>u~sulat ng estudyante ang tula].
 color pink NOM folder COMP where IMPF~write[PV] GEN student NOM poem
 ‘The folder where the student is writing the poem is pink.’

(13) PP-TARGETING *wh*-QUESTIONS AND FOCUS CONSTRUCTION

- a. {Saan /Sa kulay pink na folder} (***ang**) [nagsu~sulat ang estudyante ng tula].
 where OBL color pink LK folder NOM AV.IMPF~write NOM student GEN poem
 ‘Where is the student writing a poem?’
 ‘It’s on the pink folder that the student is writing a poem.’
- b. {Saan /Sa kulay pink na folder} (***ang**) [s<in>u~sulat ng estudyante ang tula].
 where OBL color pink LK folder NOM IMPF~write[PV] GEN student NOM poem
 ‘Where is the student writing the poem?’
 ‘It’s on the pink folder that the student is writing the poem.’

Like the non-pivot-targeting DP dependencies that form the first class of exceptions to the pivot-only restriction, these non-DP dependencies are less well-studied than the corresponding pivot-targeting cases. Research on these phenomena nevertheless exists, and particularly for the *wh*-questions and focus constructions, a major result has been that the surface differences we see between the DP- and non-DP-targeting constructions reflect true structural differences (Aldridge 2002, 2003b; Mercado 2004; Richards 1991, 1998). Given these different structures, we might reason that these non-DP cases do not constitute true exceptions to the pivot-only restriction, as they involve alternative formation strategies to the pivot-targeting cases. However, there remains the major question of why this difference in strategies exists between DP and non-DP A'-dependencies in the first place. As we will see in this thesis, the two sets of formation strategies are in fact mutually exclusive of one another: the DP strategies cannot be used to generate non-DP dependencies, and significantly, the non-DP strategies—which may seem more free—cannot be used to generate DP dependencies. Close investigation of this asymmetry in A'-dependency strategies thus has the potential to shed light on not only the non-DP strategies, but also the more well-studied DP strategies.

1.2 Main claims and motivation

This thesis investigates the range of data outlined in the previous section to form a more complete picture of A'-dependency formation in Tagalog. The central claim of the thesis is motivated by data suggesting that the movement of DPs in this language is more restricted compared to the movement of non-DPs. Scholars commonly note that *wh*-questions and focus constructions (henceforth *wh*/focus) in this language differ in structure depending on the category of their target. For example Aldridge (2002) has argued for such a contrast, such that *wh*/focus of non-DPs (14) involves fronting from a base position to the clausal left periphery, while *wh*/focus of DPs (15) takes the form of a periphrastic pseudocleft.

- (14) [Sa ilog]_{FOC} (*ang) l<um>a~langoy ang pagong t_{FOC}.
 OBL river NOM AV.IMPF~SWIM NOM turtle
 'It's in the river that the turtle is swimming.' Non-DP focus → Fronting
- (15) [DP Ang pagong] [DP *(ang) l<um>a~langoy sa ilog].
 NOM turtle NOM AV.IMPF~SWIM OBL river
 '[The one swimming in the river] is [the turtle].' DP focus → Pseudocleft

The examples provided illustrate these differences both schematically and in the English free translations. In particular, (15) highlights the periphrastic (i.e., non-dedicated) nature of the DP focus construction. This construction involves the juxtaposition of two DPs, one being the focus constituent and the other the presuppositional statement expressed as a headless relative clause. This DP-DP juxtaposition structure is independently attested in Tagalog with equative and specificational “copular” clauses (note that Tagalog does not have an overt copula). Furthermore, a number of properties provide support for the DP-hood of the presuppositional statement in this construction. In this specific example, we see the obligatoriness of a determiner, the second or intermediary *ang*, which we have seen distinguishes DP *wh*/focus from the non-DP counterpart. Headless relative clauses are also widely attested in argument positions in this language.

Assuming that the non-DP focus construction (14) is formed by conventional A'-movement of the focus constituent, the pair of examples above suggests that such movement is *not* possible for DP *wh*/focus. Otherwise, we would expect examples like (15) to be grammatical *without* the intermediary *ang*. Consequently, the periphrastic strategy is the only option for DP *wh*/focus (see also Richards 1991). Taking this observation at face value, one of the questions raised in the previous section can be made more precise. Why does Tagalog only allow a periphrastic strategy for deriving *wh*/focus of DPs? This thesis argues that the answer to this question is that A'-movement of DPs in this language is impossible.

I propose that this diminished movement capacity for DPs is due to the particular nature of Case licensing in Tagalog. I follow and extend Béjar and Massam's (1999) Multiple Case Checking analysis, which posits that Case in some languages is only PF-interpretable on a DP if that DP is in a checking configuration with the Case-assigning head, allowing DPs to receive a second value of Case after undergoing movement. I propose that Tagalog instantiates a stricter version of this interpretability requirement, such that movement may cause a DP to lose a previously assigned Case value without receiving a new one in its landing site, and that this loss of Case has implications for licensing. This proposal interacts

with standard assumptions about A' -probes and/or the landing sites of A' -movement (i.e., that they are not associated with Case, contra recent work such as Aldridge 2017b; Erlewine et al. 2015), resulting in the aforementioned inability of DPs to undergo A' -movement and the need for a periphrastic focus construction. On the other hand, non-DPs do not require Case licensing, and therefore do not show the same restrictions on A' -movement that DPs do.

The restriction on DP movement also affects the realization of relative clauses, since movement of a DP relative pronoun or an operator to a relevant A' -position is also ruled out. In light of this, I propose that the derivation of DP relative clauses proceeds via a null pronoun *pro*, which is bound by an operator at the clause edge, following the general approach of many previous proposals such as McCloskey 2002; Toosarvandani 2014; Salanova 2011, to name a few. Crucially, I show that the binding of *pro* is subject to a locality constraint whose satisfaction is fed by independent means, and that the properties of these independent means derives the attested distribution of DP-targeted A' -dependencies, including not only the cases that conform to the pivot-only restriction but also the exceptional cases outlined above. We will see that in most cases *pro* must escape the thematic domain to be sufficiently local to the operator. This escape can be fed by movement to pivot position (deriving the familiar pivot-only cases) or by an operation that I term genitive inversion, which is uniquely available to pronominal external arguments (deriving a subset of the exceptional cases). Additionally, we will see that in environments with reduced structure of a certain form, the need for *pro* to escape the thematic domain is obviated, allowing it to be bound in-situ, subsequently deriving the remainder of the exceptional cases. Finally, because the pseudocleft structure employed by DP *wh*/focus involves relative clauses, the results pertaining to the distribution of valid targets in the latter construction carry over naturally to the former.

Overall, then, this thesis proposes that two distinct mechanisms for forming A' -dependencies exist in Tagalog: a conventional A' -movement mechanism, and a mechanism involving binding of a (null) *pro*. Such mechanisms are, generally speaking, not new in the literature. However, they are standardly assumed to be clearly distinguishable, particularly in terms of locality. That is, A' -movement is standardly sensitive to phase boundaries, requiring that it take place successive-cyclically through the edges of intermediate phases, and resulting in environments where its application can be blocked (i.e., islands). In contrast, the binding of pronouns is typically understood to ignore such boundaries, and consequently does not display successive-cyclic properties or island effects. This kind of straightforward differentiation is exemplified in languages like Irish (McCloskey 2002), where we find both mechanisms co-existing. On the other hand, the analysis of Tagalog put forth in this thesis shows us that the difference between the movement-based and *pro*-based mechanisms may be harder to detect in a language that has both, as *pro*-binding may not be as free as expected. Crucially, however, the two mechanisms can still be distinguished from each other in this language, as they exhibit different locality signatures: A' -movement is sensitive to phase boundaries, as is standard; and *pro*-binding, as will be shown, is sensitive to the presence of inflectional structure.

This thesis also hopes to demonstrate a methodological point. The main topic of investigation here is a well-trodden path in the literature on Austronesian linguistics, so much so that a commonly accepted generalization (i.e., the pivot-only restriction) has formed, and much of the work focuses on accounting for that generalization on its own. As is natural in linguistic research, many different types of data are brought to bear on the analysis of the aforementioned generalization. Despite this, the wealth of data

that *does not* fit neatly into the generalization has largely gone ignored. Setting aside of exceptions and unusual cases is often necessary to arrive at a clearer understanding of many phenomena. However, in certain cases, such setting aside can be detrimental to achieving the very same understanding, as has arguably been the case with the Tagalog pivot-only restriction. What this thesis provides, then, is a proof of concept that there is value in systematically examining exceptions to a generalization, especially one as entrenched as the pivot-only restriction.

1.3 Thesis overview

The thesis is organized as follows. Chapter 2 discusses background information pertaining to Tagalog and lays out the phrase-structural assumptions adopted in this thesis, with particular attention given to the dependent-marking patterns and the distinction between DPs and PPs in this language.

Chapter 3 presents an analysis of the voice and pivot-marking system of Tagalog. It is argued that the marking that appears on pivots is assigned by the functional head spelling out Tagalog voice morphology, which is situated on the clausal spine above the domain of argument structure (i.e., above *vP*) but below IP. A treatment of pivot marking as the spell-out of abstract Case is advanced. This view is reconciled with certain non-Case-like behavior discussed in the preceding section by adopting Béjar and Massam's (1999) multiple Case checking proposal, and is further supported by a proposed deficiency in Case licensing found in certain kinds of applicative structures.

Chapter 4 presents a descriptive overview of the different *A'*-dependency constructions that are the empirical focus of this thesis. In this chapter, evidence for the structural distinction between dependencies targeting DPs and those targeting non-DPs is presented. Details of the distribution of these constructions are also discussed. In particular, it is shown that the distributional split is strongly conditioned on the category of the target, rather than some other factor, such as argumenthood.

The remaining chapters present the core proposal of the thesis as it relates to the different kinds of *A'*-dependencies. These chapters each deal with a distinct class of these constructions.

Chapter 5 deals with the well-studied cases that conform to the pivot-only restriction. This chapter presents a formalization of the pseudocleft view of DP *wh*/focus, and proposes an account for why we find the previously mentioned distributional split between DP and non-DP *wh*/focus. This account extends the Multiple Case Checking analysis adopted in Chapter 3, thus formalizing the restriction against DP *A'*-movement and addressing an overgeneration problem encountered by the most recent analyses of the distributional split. Following the discussion of *wh*/focus, an account of DP relative clauses using the null pronoun *pro* is proposed. Here, the pivot-only restriction is proposed to be a result of satisfying a locality restriction on binding *pro* through movement to the previously proposed pivot position. In addition to deriving basic local dependencies, this proposal is also shown to derive Tagalog long-distance dependencies in a way that improves on existing analyses of this phenomenon.

Chapter 6 continues the discussion by considering the case of *A'*-dependencies that target non-pivot DPs. In addition to providing a detailed description of these dependencies, this chapter shows how the analysis proposed in the preceding chapter can be extended to account for their observed distribution.

Like the pivot-targeting dependencies, this class of dependencies also relies on *pro* because of the general restriction on A'-movement of DPs. What is different in these cases, then, are the ways in which locality between *pro* and the clause-edge operator binding it can be achieved. Instead of undergoing movement to the pivot position, we will see that locality can be achieved through an alternative movement operation available to external arguments or by appearing in a syntactically reduced environment.

Chapter 7 rounds everything out by discussing the non-DP A'-dependencies. An A'-movement-based account is proposed for non-DP relative clauses and *wh*/focus, couched in the articulated left periphery of Rizzi (1997). It is shown that a range of clause-level operations that make use of the left periphery in Tagalog display certain word ordering effects that are amenable to this kind of articulation. In particular, a handful of subordinate clause types, including embedded questions, have the same *kung+wh* sequence that is found in non-DP relative clauses. This surface similarity makes it initially attractive to pursue an approach that posits a unified structure for these *kung+wh* constructions. We see, however, that these constructions make use of distinct positions in the left periphery, as evidenced by the aforementioned relative word order effects between different clause-level operations.

Finally, Chapter 8 concludes the thesis by summarizing the main results and identifying avenues for future research.

Chapter 2

Tagalog Background

This chapter provides some background on Tagalog. I begin by briefly discussing some preliminary information about the language as well as a few methodological points. The remainder of the chapter then discusses a few morphosyntactic phenomena in varying detail.

First, I give an overview of Tagalog word order and aspectual marking. This part of the discussion is primarily intended as an aid in reading the Tagalog data presented in this thesis, so I present the general patterns and point out a few areas of irregularity. I also lay out a few background theoretical assumptions for concreteness, particularly at the end of Section 2.3, where I introduce a verb form called the Recent Perfective. A number of properties exhibited by this form make it a useful testing environment for various parts of the thesis, so I discuss some of these properties, and contrast them with the rest of the aspectual system.

The most significant portion of this chapter comes at the end, where I discuss the nominal marking system in Tagalog. In addition to giving an introductory overview of the morphology of the system, the discussion here will have two main foci. First, I present evidence from Himmelmann (2016) for a categorial distinction in this nominal marking system, whereby one series of markers is prepositional, while the others are determiners. This distinction is crucial for this thesis, as it links to structural asymmetry found among *A'*-dependency constructions in this language (recall Chapter 1). Second, I discuss the patterns of nominal marking in this language, and follow previous scholars (e.g., Carrier-Duncan 1985; Chen 2017; McFarland 1976; Ramos 1974) in arguing that perhaps despite initial appearances, Tagalog exhibits a strong link between nominal marking *of a particular type* with thematic role. I propose a system of inherent Case assignment in Tagalog to account for this observation, and extend it to apply to the whole nominal marking system in the next chapter.

Notes on abbreviations, glossing conventions, and orthography can be found in the abbreviations section in the front matter (p. xiii).

2.1 Preliminaries

Tagalog is an Austronesian language of the Malayo-Polynesian branch originating from the Philippines, where it is spoken natively in the capital, Manila, and surrounding provinces (Schachter and Otones 1972). A standardized dialect of Tagalog, Filipino, serves as one of two official languages for the country (the other language being English). As such, it is also taught and spoken as a second language throughout the country (where numerous other Austronesian languages are spoken), and often serves as a *lingua franca* in many overseas Filipino communities.

Unless otherwise indicated, all Tagalog data in this thesis comes from original elicitation work or my own native speaker intuitions. Elicitation work was primarily carried out via regular in-person meetings with a few native speaker consultants roughly in their 20's, who were originally from the Philippines but had been living in the Montreal area for at least a few years. These consultants were recruited via public posts in online and in-person venues in the Montreal Filipino community. Some elicitation work was also carried out via instant messaging platforms. In this case, the speakers consulted all grew up in Manila (with most still living there), and are personally acquainted with me

To the best of my knowledge, all speakers consulted (including myself) speak the dialect of Tagalog used in Manila, although none are monolingual Tagalog speakers. Due to the linguistic situation in the Philippines, my consultants all had some degree of English proficiency (specifically in Philippine English), which is common. On the other hand, I am not aware of any of my consultants having significant proficiency in other Philippine languages, which is independently common, although perhaps less so among native Manilans. The one exception is a consultant who came from a Kapampangan-speaking background but nevertheless reported being more comfortable with Tagalog.

2.2 Word order

In this section, I highlight some general word order facts in Tagalog, with the primary intention of facilitating the reading of the Tagalog data presented in this thesis. Some of these word order phenomena will be accounted for more explicitly in later chapters, or will be used as diagnostics for structure. When this is the case, it will be indicated.

Basic word order in information-structurally neutral declarative clauses in Tagalog is predicate-initial. This word order holds across clausal predicates of different syntactic category, as shown in (1). Note that Tagalog lacks an overt copula, so the non-verbal predicates in the relevant examples below are what appear in clause-initial position.¹

(1) BASIC PREDICATE-INITIAL WORD ORDER

- a. **Nagsu~sulat** ang bata ng tula.
 AV.IMPF~write NOM child GEN poem

'The child is writing a poem.'

Verbal predicate

¹Although see Richards (2009b) for a slightly more nuanced discussion of the Tagalog copula.

- b. **Ma-daldal** ang bata.
ADJ-chatter NOM child
'The child is talkative.' Adjectival predicate
- c. **Kapatid ko** ang bata=ng ito.
sibling 1SG.GEN NOM child=LK PROX
'This child is my sibling.' Nominal predicate
- d. **Na-sa silid-aklatan** ang bata.
PRED-OBL room-book.LN NOM child
'The child is in the library.' Prepositional predicate

I follow Massam and Smallwood (1997) and Massam (2000) in deriving predicate-initiality from a different EPP specification on I^0 : whereas a language like English has a $[uD]$ feature, Tagalog has a $[uPRED]$ feature. I also follow Massam and Smallwood (1997) in assuming that this $[uPRED]$ can be satisfied in one of two ways: by head movement in the case of verbally-predicated clauses, or by phrasal movement in non-verbally-predicated clauses (see also Mercado 2004). Schematic versions of these structures are given in (2).

(2) a. VERBALLY PREDICATED CLAUSE

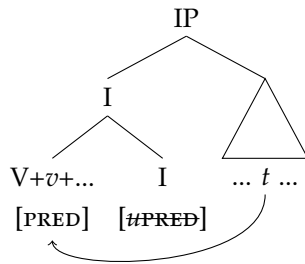

b. NON-VERBALLY PREDICATED CLAUSE

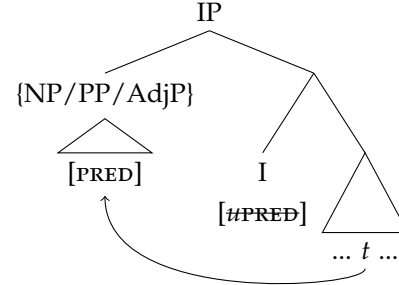

Arguments and adjuncts appear following the predicate, with their relative word order being fairly free, although some word orders are more marked than others (see, e.g., Bondoc and Schafer 2019; Hsieh 2016 for some experimental verification). On the other hand, elements that appear before the predicate can be roughly classified into two groups. The first consists of adverbial and modal particles and phrases, such as negation and some adverbs, as shown in (3). The second consists of XPs that have undergone some kind of clause-level operation, such as focus fronting and topicalization in (4). I assume that these elements occupy positions high on the clausal spine, at the IP level or higher. In Chapter 7, I provide a more concrete discussion and analysis of the Tagalog clausal left periphery and the clause-level operations shown below, which will be couched in Rizzi's (1997) articulated left periphery proposal.

(3) PRE-PREDICATE MODIFIERS

- a. [Lagi=ng] **nagsu~sulat** ng tula ang bata.
always=LK AV.IMPF~write GEN poem NOM bata
'The child always writes poems.'

- b. [Hindi] **ma-daldal** ang bata.

NEG ADJ-chatter NOM bata

‘The child isn’t talkative.’

(4) CLAUSE-LEVEL OPERATIONS

- a. [Sa silid-aklatan] **nagsu~sulat** ng tula ang bata.

OBL room-book.LN AV.IMPF~write GEN poem NOM bata

‘It’s in the library that the child is writing a poem.’

Focus fronting

- b. [Ang bata ay] **nagsu~sulat** ng tula.

NOM child TOP AV.IMPF~write GEN poem

‘As for the child, they_{SG} are writing a poem.’

Ay-inversion

Also relevant for word order are the second position clitics. These include the nominative and genitive series of pronouns as well as a number of adverbial and discourse particles. To a first approximation, these clitics encliticize onto the first element of their clause, where “element” may be a word or a phrase. For detailed discussions and analyses of the clitic placement facts, see Schachter and Otnes 1972, §6.2–6 and Kaufman 2010. Given that the placement of these clitics is sensitive to structure, we will see in Chapter 4 that they diagnose structural differences between different A' -dependency constructions. Furthermore, we will see in Section 7.3 that within the clause structure proposed in this thesis, the relevant formalization of “clause” is FocP, again following the articulated left periphery of Rizzi (1997).

(5) SECOND POSITION CLITICS

- a. K<um>a~kain **pa po kami** ng almusal.

AV.IMPF~eat still POL 1PL.EXCL.NOM GEN breakfast

‘We are still eating breakfast.’ (polite)

- b. Hindi **pa po kami** k<um>a~kain ng almusal.

NEG still POL 1PL.EXCL.NOM AV.IMPF~eat GEN breakfast

‘We still haven’t eaten breakfast.’ (polite)

On a notational note, the Leipzig Glossing Rules specify a “=” separator for indicating morphophonological cliticization. However, because the second position clitics are written as separate words in the conventional orthography, and because their status as morphophonological clitics is not in itself a central issue in this thesis, I opt not to use this separator with these elements to avoid visual clutter.

2.3 Aspect

We now turn to an overview of the aspect system of Tagalog. As with the discussion on word order, this section is partially intended as a guide in interpreting the examples provided in this thesis. In particular, I highlight areas where aspect marking system interacts morphologically with the voice system and other

verbal morphology, producing irregular forms. Certain aspectual forms which will be relevant in later discussion are also briefly introduced.

Tagalog formally marks aspect, not tense (Schachter and Otanes 1972, §2.7), displaying three semantically contentful distinctions—PERFECTIVE, IMPERFECTIVE, and FUTURE—in addition to a fourth ASPECTLESS form.² The Aspectless form behaves similarly to non-finite forms in other languages, in that it appears in a number of dependent clauses, for example as the complement of an adjective in (6d); we will see other examples such as control complements and imperatives in Section 3.1.

(6) TAGALOG ASPECT FORMS

- | | | |
|----|---|--------------|
| a. | Nag-sulat ang bata ng tula.
AV.PFV-write NOM child GEN poem
'The child wrote a poem.' | Perfective |
| b. | Nagsu~sulat ang bata ng tula.
AV.IMPF~write NOM child GEN poem
'The child {writes/is writing} a poem.' | Imperfective |
| c. | Magsu~sulat ang bata ng tula.
AV.FUT~write NOM child GEN poem
'The child will write a poem.' | Future |
| d. | Ma-hirap mag-sulat ng tula.
ADJ-difficult AV-write GEN poem
'It is hard to write poems.' | Aspectless |

That the contentful aspect forms mark aspect instead of formal tense can be seen in how they are, to some extent, compatible with various types of temporal modifiers. This effect is clearly seen with imperfective aspect. This form imparts a habitual or progressive semantics, and is by default interpreted in the present, as (7a) shows. On the other hand, (7b) shows that the same form is compatible with an adverbial phrase that shifts the relevant reference time to the past.³

(7) IMPERFECTIVE FORM IS COMPATIBLE WITH BOTH PRESENT AND PAST TENSE

- | | |
|----|--|
| a. | Nagsu~sulat ang bata ng tula.
AV.IMPF~write NOM child GEN poem
'The child {writes/is writing} a poem.' |
|----|--|

²There is some variation across authors with regards to the labels used for these aspect distinctions. In particular, Future is also commonly labeled Contemplated or Contemplative, and Aspectless is also called Basic (Schachter and Otanes 1972, §2.8) or Neutral.

³Non-verbal predicates also do not mark tense distinction. These are stative, and are interpreted as present by default, as (i) shows. As with imperfective, these predicates are compatible with a past-denoting temporal adverbial, as shown in (ii).

(i) Ma-daldal si Pedro.
ADJ-chatter NOM.P Pedro
'Pedro is talkative.'

(ii) Ma-daldal si Pedro noong bata pa siya.
ADJ-chatter NOM.P Pedro when.PST child still 3SG.NOM
'Pedro {was/*is} talkative back when he was young.'

- b. Nagsu~sulat ang bata ng tula noo[n]=ng t<in>awag-an ko siya kanina.
 AV.IMPF~write NOM child GEN poem GEN.DIST=LK <PFV>call-LV 1SG.GEN 3SG.NOM earlier
 ‘The child {was/*is} writing a poem when I called them_{SG} earlier.’

Schachter and Otnes (1972, pp.66–7) observe that two morphemes are employed compositionally to mark aspect. The first morpheme is a *CV-reduplication prefix*, which appears on the non-completed ([–COMPLETED]) aspects: Imperfective and Future. The second morpheme marks the begun ([+BEGUN]) aspects, Perfective and Imperfective, and has a form that interacts with voice morphology, but generally contains /n/. In most cases, it surfaces as the infix <in> or a word-initial *n-*, with the latter surfacing when the corresponding [–BEGUN] form bears an *m*-initial prefix.⁴ The Aspectless form bears neither of these morphemes. The aspect marking system as a whole is thus fairly regular; two representative aspect paradigms are given in Table 2.1.

Table 2.1: Aspect paradigm for LV (-an) and AV (mag-) forms of *bigay* ‘give’

LV (-an)	CV Redup.		AV (mag-)	CV Redup.	
	[+COMPL]	[–COMPL]		[+COMPL]	[–COMPL]
[–BEGUN]	<i>bigy-an</i> (Aspectless)	<i>bi~bigy-an</i> (Future)	[–BEGUN]	<i>mag-bigay</i> (Aspectless)	<i>mag-bi~bigay</i> (Future)
[+BEGUN]	<in> <i>b<in>igy-an</i> (Perfective)	<i>b<in>i~bigy-an</i> (Imperfective)	[+BEGUN]	<i>n- nag-bigay</i> (Perfective)	<i>nag-bi~bigay</i> (Imperfective)

This regularity notwithstanding, we do find some irregularity due to interactions with voice and other verbal morphology, particularly in several common forms: AV forms marked by <um>, as well as PV (-in) forms, summarized in Table 2.2. For <um> forms, there is no /n/-containing morpheme, so the Perfective and Aspectless forms are identical. Furthermore, the infix <um>, which I assume marks voice, is absent or non-overt in the Future aspect, so that this form is only marked with CV-reduplication. For -in forms, the suffix is absent/non-overt in the presence of the [+BEGUN] infix <in>. This suffix is also absent in all non-volitional PV forms.⁵

Table 2.2: Interactions between voice and aspect (irregular forms highlighted)

		ASPECTLESS	PERFECTIVE	IMPERFECTIVE	FUTURE
(‘eat’ AV)	<um> + <i>kain</i>	<i>k<um>ain</i>	<i>k<um>ain</i>	<i>k<um>a~kain</i>	<i>ka~kain</i>
(‘eat’ PV)	<i>kain</i> + -in	<i>kain-in</i>	<i>k<in>ain-Ø</i>	<i>k<in>a~kain-Ø</i>	<i>ka~kain-in</i>
(‘eat’ NVOL.PV)	<i>ma-</i> + <i>kain</i> (+ -in)	<i>ma-kain-Ø</i>	<i>na-kain-Ø</i>	<i>na-ka~kain-Ø</i>	<i>ma-ka~kain-Ø</i>
(‘pour’ AV)	<i>mag-</i> + <i>buhos</i>	<i>mag-buhos</i>	<i>nag-buhos</i>	<i>nag-bu~buhos</i>	<i>mag-bu~buhos</i>
(‘pour’ LV)	<i>buhos</i> + -an	<i>buhus-an</i>	<i>b<in>uhus-an</i>	<i>b<in>u~buhus-an</i>	<i>bu~buhus-an</i>
(‘pour’ NVOL.LV)	<i>buhos</i> + -an	<i>ma-buhus-an</i>	<i>na-buhus-an</i>	<i>na-bu~buhus-an</i>	<i>ma-bu~buhus-an</i>

⁴Alternatively, Himmelmann (2005) analyzes this system as an aspect-mood system, with CV-reduplication marking imperfective aspect, and the /n/-containing morpheme marking realis mood.

⁵Strictly speaking, this is an interaction between voice morphology and the morphology of the non-volitional form, and aspect marking behaves as we would expect from other environments. I have included this paradigm here anyway for completeness. Also, see Dell 1983 and Schachter and Otnes 1972, §5.13 for further background on the non-volitional (or ‘ability/involuntary action’) form.

In this thesis, I assume that the aspectual morphology of Tagalog (both CV-reduplication and the /n/-morpheme) is spelled out on I(nfl)⁰. This is ultimately a simplifying assumption that I make to facilitate exposition, and does not bear significantly on the analysis proposed here, which should be compatible with more articulated alternatives. For example, one might posit that aspect morphology is spelled out on Asp⁰ which is distinct from I⁰, or even that CV-reduplication and the /n/-morpheme are the reflexes of two distinct functional heads.

2.3.1 On the recent perfective

A fifth verb form, the RECENT PERFECTIVE (henceforth RPFV), is often discussed as an aspectual form in the Tagalog literature. However, a number of its properties suggest that it should be treated as a form that is formally separate from the rest of the aspect system we have just seen. These properties of RPFV clauses make them useful as a diagnostic environment of sorts. In particular, the fact that RPFV clauses lack a (nominative-marked) pivot argument will be relevant at multiple points in this thesis, starting in Section 2.4. Here, I introduce the form, pointing out a few of its distinctive properties and arguing that it should not be treated formally as an aspectual form. In later sections (primarily Section 3.1), it will be argued that the properties exhibited by the RPFV form are due to reduced syntactic structure.

The RPFV form conveys that the event described by the verb has recently occurred or been completed, and is marked by a prefix (cluster) *ka-* + CV-reduplication, with reduplication optionally targeting either the stem or the *ka-* prefix.⁶ Speakers strongly prefer having the second-position clitic adverb *lang/lamang* ‘only’ appear in the clause, otherwise, they judge the sentence to be degraded, but can nevertheless recover the intended meaning. Examples are given in (8), where we see the variability of reduplication.

(8) TAGALOG RECENT PERFECTIVE

- a. {Kaka-inom/Kai~inom} lang ng pasyente ng gamot.
 RPFV-drink RPFV~drink only GEN patient GEN medicine
 ‘The patient has just taken medicine.’
- b. {Kaka-lapag/Kala~lapag} po lamang natin sa Maynila.
 RPFV-land RPFV~land POL only 1PL.INCL.GEN OBL Manila
 ‘We have just landed in Manila.’

Given the primarily temporal semantic contribution of RPFV morphology, many scholars include RPFV as a part of the aspectual system in Tagalog (e.g., Schachter and Otnes 1972; Ramos 1974; McGinn 1988). However, there are a number of reasons to treat this form as formally distinct from the other aspect forms. Perhaps most commonly noted is the fact that RPFV clauses lack a pivot (Kroeger 1993; Odango and Otsuka 2015; Erlewine et al. 2017), which is otherwise present in clauses bearing any other value of aspect, including Aspectless. As (8) shows, all non-oblique arguments of RPFV clauses are marked

⁶This optionality represents variation within a single speaker, and appears to be relatively free to a first approximation. However, there may be sub-patterns in the application of reduplication conditioned on other morphology present, and there is occasionally a perception that stem reduplication is the prescriptively correct form. This type of variation in reduplication is also attested outside of RPFV. See Ryan 2010 for discussion.

genitive. Relatedly, RPFV verbs also do not bear any recognizable voice morphology (i.e., *m-/<um>*, *-in*, *-an*, or *i-*; see Section 3.1.1).

Another crucial difference with the rest of the aspectual system is the fact that this form does not bear any of the morphology recognizable from the main paradigm. First, the prefix *ka-* is not obviously related to (temporal) aspect, in that it does not mark such distinctions elsewhere in the language.⁷ On the other hand, CV-reduplication in RPFV has the same form as the morpheme marking [–COMPL] forms in the main aspectual paradigm. Other than morphological similarity however, it is not clear that the two morphemes share any other properties in common. In particular, it is hard to argue for RPFV having a semantic component of non-completedness, given that it clearly conveys the opposite. It is therefore more natural to treat the two instances of CV-reduplication as formally distinct morphemes.

The properties just outlined suggest that RPFV clauses have a distinct structure from the more typical declarative clause examples that we have seen so far. In Section 3.1, I show that what makes RPFV clauses different from other declarative clauses is their reduced syntactic structure. This reduced syntactic structure is then shown to have implications for the distribution of DP A'-dependencies that target non-pivots (Chap. 6), as well as the syntactic position of various elements found in the clausal left periphery (Chap. 7).

2.4 Dependent marking

I now turn to a discussion of nominal marking in Tagalog, beginning with a short descriptive overview of its morphological realization in Section 2.4.1. I then argue in favor of adopting a categorial distinction within the nominal marking system, following Himmelmann (2016). It will be shown that of the three nominal markers discussed, two (nominative and genitive) are formally Case-bearing determiners, while the other (oblique) is prepositional. This categorial distinction is significant, as it tracks the structural asymmetries in A'-dependency constructions—introduced in the previous chapter and discussed in more detail in Chapter 4—that constitute one of the main areas of inquiry of this thesis. Finally, I discuss the assignment patterns of Tagalog nominal marking, and show that a subset of this system shows a strong link with the thematic role of the marked nominal. I propose a system of Case assignment to account for this, which is developed further in Chapter 3.

2.4.1 Surface realization of nominal marking

Tagalog displays a three-way distinction in marking clausal dependents. Nominals can be marked NOMINATIVE, GENITIVE, or OBLIQUE, as shown in (9). Full noun phrases are marked with phrase-initial particles that are sensitive to whether their complement is common or personal (= [+PROPER, +ANIMATE]), as (9a) and (9b) show, respectively. For personal pronouns, interrogative pronouns, and demonstratives, a dis-

⁷However, this prefix may be related to other instances of *ka-* that appear to encode resultative meanings. For example, non-volitional (also called Ability/Involuntary Action) forms have previously been described as having a more endpoint- or result-oriented semantics (Dell 1983). AV forms of these verbs are marked *maka-/naka-* (see also Travis 2000a). Another example is in gerunds marked *pagka-*, which Schachter and Otnes (1972, §3.26) label *perfective gerunds*. These appear to denote the result states of events. For example *pag-sulat* refers more to the motions of writing (modifiable with *mabilis* 'fast') whereas *pagka-sulat* refers more to the resulting text (usually its appearance, so modifiable with *maganda* 'good, beautiful').

tinct morphological form is typically used instead. Exceptions to this are the oblique series of personal pronouns (which are marked with *sa*), and the genitive common *wh*-pronoun.⁸ An example sentence with pronouns is given in (9c), and a full case paradigm is given in Table 2.3.

(9) NOMINAL MARKING

- a. I-ni-lagay **ng** guro **ang** yeso **sa** lamesa.
CV-PFV-put GEN teacher NOM chalk OBL table
'The teacher put the chalk on the table.' Common noun markers
- b. I-p<in>a-kilala **ni** Alex **si** Bing **kay** Charina.
CV-<PFV>CAUS-acquaint GEN.P Alex NOM.P Bing OBL.P Charina
'Alex introduced Bing to Charina.' Personal noun markers
- c. I-p<in>a-kilala **ko** **sila** **sa** iyo.
CV-<PFV>CAUS-acquaint 1SG.GEN 3PL.NOM OBL 2SG.OBL
'I introduced them to you.' Pronoun forms

Table 2.3: Nominal marking paradigm for Tagalog

	NOMINATIVE	GENITIVE	OBLIQUE
Common nouns	<i>ang</i> NP	<i>ng</i> NP	<i>sa</i> NP
Personal singular	<i>si</i> NAME	<i>ni</i> NAME	<i>kay</i> NAME
Personal plural	<i>sina/sila</i> NAME(S)	<i>nina/nila</i> NAME(S)	<i>kina/kila</i> NAME(S)
1SG	<i>ako</i>	<i>ko</i>	<i>sa akin</i>
2SG	<i>ikaw/=ka</i>	<i>mo</i>	<i>sa iyo</i>
3SG	<i>siya</i>	<i>niya</i>	<i>sa kanya</i>
1PL.EXCL	<i>kami</i>	<i>namin</i>	<i>sa amin</i>
1PL.INCL	<i>tayo</i>	<i>natin</i>	<i>sa atin</i>
2PL	<i>kayo</i>	<i>ninyo</i>	<i>sa inyo</i>
3PL	<i>sila</i>	<i>nila</i>	<i>sa kanila</i>
<i>Wh</i> common	<i>ano</i>	<i>ng ano</i>	<i>saan</i>
<i>Wh</i> personal	<i>sino</i>	<i>nino</i>	<i>kanino</i>
DEM PROX	<i>ito</i>	<i>nito</i>	<i>dito</i>
DEM MED	<i>iyang</i>	<i>niyang</i>	<i>diyang</i>
DEM DIST	<i>iyon</i>	<i>noon/niyon</i>	<i>doon</i>

These markers are generally used in the following ways. Nominative marking (i.e., *ang*, *si*, etc.) is in many ways the unmarked form. For example, it is used when uttering nominals in isolation. Nominative also marks the syntactically prominent/privileged argument of the clause, which I will refer to in this thesis as the pivot (see Sec. 3.1).⁹ As we will see, many (but not all) clauses have a nominative argument.

⁸The oblique pronouns may appear without *sa*-marking in certain cases, most of which have the pronoun taking on a possessive function. This is discussed in detail in Section 6.2. See Schachter and Otnes 1972, §3.20 for examples and discussion. See also Culwell-Kanarek 2005 and Kaufman 2010 for a treatment of the *sa*-less oblique series pronouns as freestanding genitive pronouns, counterpart to the obligatorily clitic genitive pronouns. For example, under this view the first person singular *akin* is the free counterpart to the clitic *ko*, in the same way that the second person singular *ikaw* is the free counterpart to the clitic *ka*.

⁹As noted in the introduction, the formal status of the pivot in Tagalog and other languages with Philippine-type alignment has

Next, genitive marks possessors as well core arguments (usually agents, experiencers, and themes) that do not have subject/pivot status. Lastly, oblique is more prepositional in its syntactic behavior and semantic characteristics, as it introduces more peripheral elements such as locations, goals, sources, and so on.

2.4.2 Categorical status

The nominative, genitive, and oblique markers all introduce nominals that are clausal dependents, but there is evidence that these markers do not all belong to the same syntactic category. For example, we saw in Table 2.3 that the oblique series pronouns are marked differently from those in the other two series, requiring the oblique marker (*sa*). We might take this behavior as evidence for a distinct syntactic category for oblique. Indeed, Himmelmann (2016) notes a number of other ways in which oblique phrases are distinct from nominative and genitive phrases, and argues that oblique *sa/kay* is a preposition, while nominative *ang/si* and genitive *ng/ni* are determiners. Thus, nominal phrases with oblique marking are formally PPs, while those with nominative or genitive marking are formally DPs

This distinction is significant, since it is the determining factor for the structural asymmetry in A'-dependency constructions that is the main focus of this thesis. That is, I show in Chapter 4 that the distribution of A'-dependency constructions in Tagalog is crucially conditioned on whether the target of the dependency corresponds to a nominative-/genitive-marked position or an oblique-marked one. Thus, adopting the view that nominative- and genitive-marked nominals are DPs while oblique-marked ones are PPs provides us with a starting point from which to develop an analysis of the structural asymmetry. Here, I summarize the main arguments he gives for adopting such a split between the markers.

2.4.2.1 Compatibility with a stative prefix

The first behavior unique to oblique-marked nominals is that, when appearing as (stative) predicates, they may take a prefix *na-*, used to express a stative locative meaning 'be in/at/on etc.' (Himmelmann 2016; see also Mercado 2004; Kaufman 2009). The prefix attaches to any type of oblique-marked phrase, as shown in (10).¹⁰

(10) STATIVE OBLIQUE PREFIX

- a. {**Na-sa** Montreal/**Nan-dito** } ang Lachine Canal.
 PRED-OBL Montreal PRED-OBL.PROX NOM Lachine Canal
 'The Lachine Canal is {in Montreal/here}.'
- b. {**Na-kay** Carla/**Na-sa** akin } ang cellphone ni Stan.
 PRED-OBL.P Carla PRED-OBL 1SG.OBL NOM cellphone GEN.P Stan
 'Stan's cellphone is with {Carlo/me}'

been actively debated in the literature over the decades, with a number of different labels applied to it. Other common labels are 'subject', 'focus', and 'topic'. As these terms have well-established meanings outside of Philippine linguistics, I avoid directly using them to minimize any potential confusion. Instead, I opt for a more distinct term that serves as a perhaps more pre-theoretic label. I present my analysis for the pivot in Chapter 3.

¹⁰We find some variation in surface realization when *na-* attaches to demonstratives. (10a) shows *nan-dito*, which is more typical of colloquial speech. Also possible is *na-rito*, which exhibits the Tagalog *d/r* allophony (see Schachter and Otones 1972, §1.20) and is more morphologically parallel to the other examples, but is also more typical of formal speech.

- c. {**Na-saan** /**Na-kanino** } ang gamot ni lola?
 PRED-where(OBL) PRED-who.OBL NOM medicine GEN.P lola
 ‘{Where/With whom} is grandma’s medicine?’

This prefix may not appear on any of the nominative or genitive series forms. Thus, there are no forms like *na-ang*, *na-ng* (i.e., /nanang/), *na-si*, etc. Instead, bare nominative phrases may appear directly as clausal predicates (11a), while bare genitive phrases cannot appear at all in this environment (11b). Note also that (11c) shows that oblique phrases may function predicatively without *na-*, in which case they often denote a possession relation.

- (11) a. (*Na-)Ang aso ni Maria ang pinaka-ma-laki.
 PRED-NOM dog GEN.P Maria NOM SUPL-ADJ-big
 ‘The biggest one is Maria’s dog.’
- b. (*Na-)Ni Maria ang pinaka-ma-laki=ng aso.
 PRED-GEN.P Maria NOM SUPL-ADJ-big=LK dog
 Intended: ‘The biggest dog is Maria’s.’
- c. Kay Maria ang pinaka-ma-laki=ng aso.
 OBL.P Maria NOM SUPL-ADJ-big=LK dog
 ‘The biggest dog is Maria’s.’

Assuming that *na-* selects for phrases of a particular category, we can take this behavior to indicate that oblique-marked phrases are categorially distinct from those that are marked nominative and genitive.

2.4.2.2 Co-occurrence or lack thereof

The second piece of evidence relates to co-occurrence. Himmelmann (2016) observes that certain sequences of consecutive nominal markers are attested in Tagalog. Specifically, (12) shows that we find examples of nominative-oblique and genitive-oblique, whereas we see in (13) that nominative-genitive and vice versa are ungrammatical. Himmelmann also notes that in cases with co-occurrence, the oblique marker always follows the nominative or genitive one.

(12) CO-OCCURRENCE OF OBLIQUE AND NOMINATIVE/GENITIVE MARKING

- a. g<in>a~gawa na **ang sa** Barangay Catmon
 IMPF~make[PV] now NOM OBL barangay Catmon
 ‘the one in Barangay Catmon is currently under construction’

(Himmelmann 2016, p.323, glosses modified)

- b. Ang mga tula sa Filipino, tulad **ng sa** Ingles, Aleman at Pranses, ay karaniwa[n]=ng
 NOM PL poem OBL Filipino similar GEN OBL English German and French TOP common=LK
 may tugma.
 EXIS rhyme

‘Poems in Filipino, like those in English, German, and French, commonly have rhymes.’

(Santiago 2003, p.148)

(13) COMPLEMENTARY DISTRIBUTION OF NOMINATIVE AND GENITIVE

- a. G<in>a~gawa na **ang** *(ospital) **ng** Barangay Catmon.
 IMPF~make[PV] now NOM hospital GEN barangay Catmon

‘the {hospital/*one} of Barangay Catmon is currently under construction’

- b. Ang Filipino, tulad **ng** (***ang**) Ingles, Aleman at Pranses, ay isa=ng wika.
 NOM Filipino like GEN NOM English German and French TOP one=LK language

‘Filipino, like English, German, and French, is a language.’

The contrasting behavior between oblique and non-oblique phrases can be tied to the fact that noun modifiers of various types in Tagalog readily appear with nominal marking even in the absence of an overt noun. See, for example, *pinakamalaki* ‘biggest’ in (11). In such cases, we might assume that there is an empty nominal head being modified. Thus, (12) shows us that oblique phrases have this kind of modificational use. We might assume, for example that *ang* or *ng* in these examples marks an empty nominal head, which in turn is modified by the oblique phrase. In contrast, we see in (13) that the non-oblique nominative and genitive phrases cannot be used in a similar way. Such behavior is in turn unsurprising if oblique phrases were formally PPs, while nominative and genitive phrases were DPs.

The contrast can also be understood in an alternative way, as Himmelmann argues. He refrains from positing phonologically empty material, and takes the non-co-occurrence of nominative and genitive marking in (13) to suggest that they are of the *same* category. Following this, the co-occurrence of oblique and non-oblique in (12) shows that oblique marking is of a distinct category. Assuming that oblique instantiates P⁰ while nominative and genitive instantiate D⁰, Himmelmann further concludes from examples like (12) that D⁰ may select PPs (but not vice versa) in Tagalog.

In either case, this co-occurrence contrast shows us that oblique phrases are formally distinct from non-oblique phrases.

It is also worth pointing out that the behavior shown in (12) is general across different kinds of oblique phrases, as (14) shows with pronominal and personal noun oblique phrases. Note that the oblique phrases in these examples are interpreted as possessors, which is also what we find with (non-*na*-marked) oblique phrases that are clausal predicates, such as in (11c) in Section 2.4.2.1.

(14) NOMINATIVE/GENITIVE WITH DIFFERENT TYPES OF OBLIQUE PHRASES

- a. G<in>a~gawa na **ang** {**kay** Mina/**sa** akin }.
 IMPF~make[PV] now NOM OBL.P Mina OBL 1SG.OBL

‘{Mina’s/Mine} is currently being made.’

- b. Ang buhok ni George, tulad ng {kay Pia/sa iyo }, ay ma-haba.
 NOM hair GEN.P George like GEN OBL.P Pia OBL 2SG.OBL TOP ADJ-long
 ‘George’s hair, like {Pia’s/yours}, is long.’

2.4.2.3 Demonstratives

Perhaps the clearest evidence that there is a difference in syntactic category between the different dependent markers—as well as what exactly this difference is—comes from the behavior of demonstrative expressions. We will see that nominative *ang* and genitive *ng*, but not oblique *sa*, alternate with the corresponding demonstratives, providing strong evidence that *ang* and *ng* are of category D, while *sa* is not.

Demonstratives may surface in a number of different ways in Tagalog. Most relevant to current purposes is that demonstratives can appear pre-nominally or phrase-initially, where Himmelmann (2016) points out that the nominative and genitive series demonstratives behave differently from the oblique series.¹¹ In nominative- and genitive-marked phrases, the regular markers *ang* and *ng* are replaced by a demonstrative from the same series followed by the linker. In (15), compare the demonstrative-marked phrase in one example with the corresponding phrase without the demonstrative in the other example.

(15) REPLACEMENT WITH NOMINATIVE AND GENITIVE PRE-NOMINAL DEMONSTRATIVES

- a. I-la~lagay ng mga guro iya[n]=ng mga libro sa mga lamesa.
 CV-FUT~put GEN PL teacher MED(NOM)=LK PL book MED OBL PL
 ‘The teachers will put those books on the tables.’
- b. I-la~lagay nito=ng mga guro ang mga libro sa mga lamesa.
 CV-FUT~put PROX.GEN=LK PL teacher NOM PL book OBL PL table
 ‘These teachers will put the books on the tables.’

Furthermore, we see in (16-17) that this replacement strategy is obligatory. A pre-nominal demonstrative cannot co-occur with *ang* or *ng* on the same nominal, regardless of their relative order or the presence of the linker. Following Himmelmann, we can treat this alternation between nominal markers and their respective demonstratives as an instance of complementary distribution. These morphemes must therefore appear on the same syntactic head. Since this behavior involves demonstratives, the natural conclusion is that the relevant head is D⁰.

(16) NO JUXTAPOSITION WITH NOMINATIVE PRE-NOMINAL DEMONSTRATIVES

- a. *I-la~lagay ng mga guro iya[n](=ng) ang mga libro sa mga lamesa.
 CV-FUT~put GEN PL teacher MED(NOM)=LK NOM PL book OBL PL table
 Intended: ‘The teachers will put those books on the tables.’

¹¹Post-nominal and freestanding demonstratives are also possible in Tagalog. Freestanding demonstratives simply take the place of and bear the same marking as full nominal phrases. Post-nominal demonstratives appear within a nominal phrase and have a modificational function. The behavior of these is ultimately not useful for distinguishing between the three series of dependent marking, but see Himmelmann 2016 for more details.

- b. *I-la~lagay ng mga guro **ang iya[n](=ng)** mga libro sa mga lamesa.
 CV-FUT~put GEN PL teacher NOM MED(NOM)=LK PL book OBL PL table
 Intended: ‘The teachers will put those books on the tables.’

(17) NO JUXTAPOSITION WITH GENITIVE PRE-NOMINAL DEMONSTRATIVES

- a. *I-la~lagay **nito(=ng) ng** mga guro ang mga libro sa mga lamesa.
 CV-FUT~put GEN.PROX=LK GEN PL teacher NOM PL book OBL PL table
 Intended: ‘These teachers will put the books on the tables.’
- b. *I-la~lagay **ng nito(=ng)** mga guro ang mga libro sa mga lamesa.
 CV-FUT~put GEN GEN.PROX=LK PL teacher NOM PL book OBL PL table
 Intended: ‘These teachers will put the books on the tables.’

Compare now the behavior of oblique pre-nominal demonstratives. As (18) shows, the demonstrative *must* appear juxtaposed with the regular oblique marker, instead of replacing it. This is the opposite of what we just saw in (15-17).

(18) JUXTAPOSITION WITH OBLIQUE PRE-NOMINAL DEMONSTRATIVES

- a. I-la~lagay ng mga guro ang mga libro **doon sa** mga lamesa.
 CV-FUT~put GEN PL teacher NOM PL book OBL.DIST OBL PL table
 ‘The teachers will put the books (there) on those tables.’ Juxtaposition
- b. *I-la~lagay ng mga guro ang mga libro **doo[n]=ng** mga lamesa.
 CV-FUT~put GEN PL teacher NOM PL book OBL.DIST=LK PL table
 Intended: ‘The teachers will put the books on those tables.’ *Replacement

In addition to this contrast between juxtaposition and replacement that Himmelmann observes, there is further evidence that I argue supports the conclusion that the difference between nominative/genitive and oblique must be syntactic in nature. For example, the ungrammaticality of (18b) cannot simply be due to some morphological incompatibility between the oblique demonstratives and the linker. Such sequences are attested elsewhere in the language, as illustrated in (19). Note that in these examples, the demonstrative does not mark the nominal it precedes, but instead serves as a locative expression for another predicate. In (19a) this is the existential predicate, and in (19b) this is the verb *binili* ‘bought’ contained within a relative clause.

(19) SEQUENCES OF OBLIQUE DEMONSTRATIVE + LINKER ARE WELL-FORMED

- a. Meron {**dito=ng / diya[n]=ng / doo[n]=ng**} kuryente.
 EXIS OBL.PROX=LK OBL.MED=LK OBL.DIST=LK electricity
 ‘There is electricity {here/there}.’
- b. Para sa iyo ang [b<in>ili ko {**dito=ng / diya[n]=ng / doo[n]=ng**}] pasalubong.
 for OBL 2SG.OBL NOM <PFV>buy[PV] 1SG.GEN OBL.PROX=LK OBL.MED=LK OBL.DIST=LK souvenir
 ‘The souvenir [that I bought {here/there}] is for you.’

Furthermore, we find syntactic and semantic differences between the replacement and juxtaposition strategies for pre-nominal demonstratives. On the semantic side, juxtaposed demonstratives are less determiner-like than replacive ones, in that they do not clearly modify (loosely speaking) their corresponding phrase. For example, the sentences in (20) show that proper nouns are compatible with oblique pre-nominal demonstratives, but not otherwise. The intuition is that the oblique demonstrative in (20a) is not picking out a particular member of a salient “set of Torontos”. Rather, *doon* and *sa Toronto* in (20a) both index the same entity, and they stand in some kind of appositive relationship.

- (20) a. Mas gusto ni Korina (doon) sa Toronto.
 COMP like GEN.P Korina OBL.DIST OBL Toronto
 ‘Korina likes it better (there) in Toronto.’
- b. Mas gusto ni Mel {ang /*ito=ng } Montreal.
 COMP like GEN.P Mel NOM PROX(NOM)=LK Montreal
 ‘Mel likes (*this) Montreal better.’

That the oblique demonstrative is in some sense more separate from the full oblique phrase can also be seen syntactically. Oblique phrases with pre-nominal demonstratives can be focused in more than one way. Perhaps most expectedly, the entire phrase including the demonstrative can appear in clause-initial focus position, as shown in (21b). It is also possible for just the demonstrative to appear in focus position, with the oblique phrase itself surfacing in-situ, as (21c) shows.¹²

(21) FOCUS OF AN OBLIQUE PHRASE WITH A PRE-NOMINAL DEMONSTRATIVE

- a. Naghi~hintay si Brenda **doon sa parke**.
 AV.IMPF~wait NOM.P Brenda OBL.DIST OBL park
 ‘Brenda is waiting there in the park.’ Baseline
- b. **Doon sa parke** naghi~hintay si Brenda.
 OBL.DIST OBL park AV.IMPF~wait NOM.P Brenda
 ‘It’s there in the park that Brenda is waiting.’ Both fronting
- c. **Doon** naghi~hintay si Brenda **sa parke**.
 OBL.DIST AV.IMPF~wait NOM.P Brenda OBL park
 ‘It’s there that Brenda is waiting, in the park.’ Demonstrative fronting

¹²A concrete account for this “splitting” behavior is left for future work. Notably, more data than that presented in (21) bears on this issue. For example, the “separation” of the demonstrative that we saw in (21c) is impossible in some environments. Second-position clitic placement is possible when the (oblique) demonstrative is freestanding, but not when pre-nominal (i.e., when a correlate oblique phrase is present). It is also not possible to front the oblique phrase, leaving the demonstrative in-situ. Compare (i) with (21c).

- (i) a. Naghi~hintay **doon** si Brenda (***sa parke**).
 AV.FUT~wait OBL.DIST NOM.P Brenda OBL park
 Intended: ‘Brenda is waiting there in the park.’ *Pre-nominal demonstrative as second-position clitic
- b. ***Sa parke** naghi~hintay si Brenda **doon**.
 OBL park AV.IMPF~wait NOM.P Brenda OBL.DIST
 Intended: ‘It’s in the park that Brenda is waiting, there.’ *Oblique phrase fronting

In contrast, separating the demonstrative from the rest of the phrase is not possible with non-oblique demonstratives, as is shown in (22).

(22) FOCUS OF A NOMINATIVE PHRASE WITH A PRE-NOMINAL DEMONSTRATIVE

- a. Nag-a~aral **ito=ng** **bata** sa pampubliko=ng paaralan.
 AV.IMPF~study PROX(NOM)=LK child OBL public=LK school
 ‘This child studies in a public school.’ Baseline
- b. **Ito=ng** **bata** ang nag-a~aral sa pampubliko=ng paaralan.
 PROX(NOM)=LK child NOM AV.IMPF~study OBL public=LK school
 ‘The one who studies in a public school is this child.’ Both fronting
- c. ***Ito** ang nag-a~aral (ang) **bata** sa pampubliko=ng paaralan.
 PROX(NOM) NOM AV.IMPF~study NOM child OBL public=LK school
 Intended: ‘The one who studies in a public school is this child.’ *Demonstrative fronting

The difference between juxtaposition and replacement in oblique vs non-oblique demonstratives is thus indicative of a syntactic difference between the two kinds of phrases. We previously concluded that nominative and genitive marking instantiated D^0 due to the replacement behavior exhibited by the non-oblique demonstratives. Conversely, then, we can take obligatory juxtaposition of oblique demonstratives to conclude that oblique marking is *not* an instance of D^0 . Given its adpositional meaning, Himmelmann (2016) concludes that oblique marking must instantiate P^0 .¹³

2.4.3 Underlying patterns

Having discussed the categorial status of the nominal markers, let us now turn to their assignment patterns. In this section, we will see that a subset of nominal marking in Tagalog exhibits a close link to thematic role. To account for this behavior, I propose that Tagalog systematically assigns Case to DP arguments in-situ. In the next chapter, I extend this Case assignment proposal to account for the full nominal marking system.

It has been noted previously by a number of scholars (e.g., Carrier-Duncan 1985; Chen 2017; McFarland 1976; Ramos 1974) that the nominal marking patterns in Tagalog are strongly conditioned by thematic role, if nominative marking is ignored. That is, if an argument is not marked nominative, it will bear marking based on its thematic role. In particular, we find the main general correspondences shown

¹³One other major piece of evidence that Himmelmann (2016) provides for arguing that oblique marking instantiates P^0 is that it may co-occur with elements that contribute more specific prepositional meanings, however this data is arguably inconclusive. Examples include *dahil sa X* ‘because of X’, *para sa X* ‘for X’, *gáling sa X* ‘from X’. Himmelmann assumes without much argument that such elements are specifiers of PPs. While these purported specifiers, such as *dahil*, indeed do not occur with nominative or genitive phrases, it is not immediately clear that they should be specifiers, much less specifiers of PP. On one hand, a few of these elements have a second, more complementizer-like function, in which they introduce clauses (e.g., *dahil [umuulan]* ‘because [it is raining]’ vs *dahil [sa ulan]* ‘because [of the rain]’). On the other, we find other adverbial/adjunct-like phrases that appear with nominative and genitive phrases, such as *tulad ng X* ‘like X’ (see Sec. 2.4.2.2) and *gámit ang X* ‘using (the) X’. Such data is perhaps more appropriately treated as having the structure of complementation, in which case we could characterize the obligatory appearance of oblique with elements like *dahil*, *para*, and *gáling* in one of at least two ways. First, these elements might specifically select for PPs, consistent with the overall claim of this subsection. Second, they might select DPs generally and instead assign oblique case to their complement.

in Table 2.4.¹⁴

Table 2.4: Underlying dependent marking patterns

	Highest Ext. Arg.	Causees	Themes	Peripheral
CASE	GEN <i>ng/ni</i>	OBL <i>sa/kay</i>	GEN <i>ng</i> (Indef.) OBL <i>sa/kay</i> (Def.)	OBL <i>sa/kay</i> or adverbial phrase

Some examples of this underlying case marking are provided below. In (23-24), we see the underlying case patterns for ditransitive and causative clauses, which become evident when we change the voice specification on the verb (a-c), as well as when the verb appears in certain other forms that lack voice morphology (d-e).

(23) DIFFERENT “VERSIONS” OF A DITRANSITIVE CLAUSE

	VERB	AGENT	THEME	GOAL	
a.	Mag-bi~bigay	ako	ng regalo	kay Sisa.	AV (NOM Agent)
b.	I-bi~bigay	ko	ang regalo	kay Sisa.	CV (NOM Theme)
c.	Bi~bigy-an	ko	ng regalo	si Sisa.	LV (NOM Goal)
d.	Ka-bi~bigay	ko lang	ng regalo	kay Sisa.	Recent Perfective (no NOM)
e.	(ang) pag-bi~bigay	ko	ng regalo	kay Sisa	Gerund (no NOM)
	give	1SG.GEN	GEN gift	OBL.P Sisa	

≈‘I {will give/have just given} a/the gift to Sisa.’; ‘my giving of a gift to Sisa’

(24) DIFFERENT “VERSIONS” OF A CAUSATIVE CLAUSE

	VERB	AGENT	CAUSEE	THEME	
a.	Mag-pa~pa-luto	ako	kay Simoun	ng isda.	AV (NOM Agent)
b.	Pag-lu~lutu-in	ko	si Simoun	ng isda.	PV (NOM Causee)
c.	I-pa~pa-luto	ko	kay Simoun	ang isda.	CV (NOM Theme)
d.	Ka-pa~pa-luto	ko lang	kay Simoun	ng isda.	Recent Perfective (no NOM)
e.	(ang) pag-pa~pa-luto	ko	kay Simoun	ng isda	Gerund (no NOM)
	cook	1SG.GEN	OBL.P Simoun	GEN fish	

≈‘I {will make/have just made} Simoun cook (the) fish.’; ‘my making Simoun cook fish’

Similar behavior can be found with intransitives of different types, although the data is not as immediately obvious because the sole argument in a typical declarative intransitive clause will, by default, be marked nominative, obscuring the underlying marking. This situation is what we see with the unergative verb *ngiti* ‘smile’ in (25a). However, it is possible to change the voice specification on the verb to one that targets a more peripheral dependent, such as a goal. In this case, the underlying genitive on the agent *Basilio* surfaces, as shown in (25b-c). Here, we can be sure that the genitive marking that we see corresponds to an agent position because it marks a proper name, which is formally definite. This contrasts with what we find with definite themes, which must bear oblique marking and not genitive, in environ-

¹⁴Pronouns and proper nouns count as definite for determining theme marking. Note that formally definite themes are typically ungrammatical in non-PV voice-marked contexts, but are well-formed in other environments.

ments where definite (non-pivot) themes are licensed. As (25) shows, oblique marking is ungrammatical on *Basilio*. Finally (25d) shows supporting evidence from a gerund.

(25) DIFFERENT “VERSIONS” OF AN UNERGATIVE CLAUSE

	VERB	AGENT	(APPL.) GOAL	
a.	Ng<um>iti	si Basilio	(sa kapatid niya).	AV
b.	Ng<in>iti-an	{ni/*kay} Basilio	ang kapatid niya.	LV
c.	Na-ngiti-an	{ni/*kay} Basilio	ang kapatid niya.	LV NVol
d. (ang)	pag-ngiti smile	{ni/*kay} Basilio {GEN.P/*OBL.P} Basilio	(sa kapatid niya) OBL sibling 3SG.GEN	Gerund

≈‘Basilio smiled at his sibling.’; ‘Basilio’s smiling at his sibling’

The dependent marking patterns in unaccusatives similarly tracks thematic role, as (26) shows. As with the unergative example, the sole argument of *bagsak* ‘fall, crash’, here *pasô* ‘flowerpot’, is typically marked NOM, as in (26a). Again, with a different voice form targeting a peripheral dependent, we see the underlying marking resurface (26b-c). We also see the same marking in environments with no *ang*-marking (26d). In this case, we know that the underlying case indicates a theme position because it is compatible with the presence of an unambiguous agent, such as the genitive-marked proper name shown here.

(26) DIFFERENT “VERSIONS” OF AN UNACCUSATIVE CLAUSE¹⁵

	VERB	AGENT	(APPL.) GOAL	THEME	
a.	B<um>agsak		(sa kotse)	ang pasô.	AV
b.	B<in>agsak-an	ni Jenny	ang kotse	ng pasô.	LV
c.	Na-bagsak-an	(ni Jenny)	ang kotse	ng pasô.	LV NVol
d. (ang)	pag-bagsak fall/crash	(ni Jenny) GEN.P Jenny	(sa kotse) OBL car 3SG.GEN	ng pasô GEN flowerpot	Gerund

≈‘A flowerpot fell (on the car).’; ‘Jenny dropped/smashed a flowerpot on the car.’

I propose that the close link between the underlying marking that we see and the corresponding thematic role can be accounted for as inherent Case, that is, Case linked to theta-positions. In particular, I assume that inherent genitive Case is assigned to the specifier of a *v*P headed by an agentive *v*⁰.¹⁶ On the other hand, (indefinite) themes also receive inherent genitive Case in their theta position, the complement of *V*⁰.

Following the discussion in Section 2.4.2, I assume that oblique-marked dependents enter the derivation as PPs. These can be selected for, as with goal arguments or causees, or they can be more adjunct-like, as with locations. Regardless, these enter the derivation as PPs and thus do not themselves receive Case from an external source.

All this being said, major questions remain about the nature and distribution of *ang*-marking. What

¹⁵It is possible to also have *ang pagbagsak ni Jenny* without *pasô* ‘flowerpot’, in which case there is a strong preference for an alternative reading: ‘Jenny’s failing (the exam/class)’, although it can also mean ‘Jenny’s collapsing’. Note that in this case, we do not have *kay Jenny*, as we might expect from an underlying object. My judgment is that oblique is possible on the object, but it results in an implicit agent reading (i.e., *ang pagbagsak sa pasô* ‘the dropping/smashing of the flowerpot (by someone)’) This may be indicative of some kind of transitivity alternation that is independent of the voice system. For example, compare the view that AV clauses are syntactically intransitive/antipassive while non-AV forms are transitive (see, e.g., Aldridge 2004a; Ross 2009).

¹⁶This is formally identical to inherent *ergative* Case proposed for other languages (Woolford 2006; Legate 2012).

Table 2.5: Underlying dependent marking patterns with sources

	Highest Ext. Arg.	Causees	Themes	Peripheral
CASE	GEN <i>ng/ni</i>	OBL <i>sa/kay</i>	GEN <i>ng</i> (Indef.) OBL <i>sa/kay</i> (Def.)	OBL <i>sa/kay</i> or adverbial phrase
SOURCE	(Agentive) v^0	Prepositional	V^0	Prepositional/adverbial

is it formally? What determines its presence and which clausal dependent it marks? I turn to these issues in the next chapter.

2.5 Summary

In this chapter, I have discussed a number of background details of Tagalog morphosyntax, and laid out a few theoretical assumptions that I adopt. The most significant of these are the prepositional status of the oblique (i.e., *sa*) series of dependent marking, and a rough template for the Tagalog clausal spine, shown in (27), which also summarizes the various properties of each projection. Included in this template is the functional head Agr^0 , which I have not yet discussed. This functional head is discussed in Chapter 3, where I propose that it is the functional head that spells out voice morphology and is the locus of nominative Case.

(27) CLAUSAL SPINE TEMPLATE: **C** > **I(nfl)** > **Agr** > v > **V**

- a. **V**: Lexical verb root
- b. v : Valency-changing and external argument-introducing heads
 - Likely a range/hierarchy of projections
 - Some morphological realizations include: agent-introducing/lexical causative *pag-/paN-* and productive causative *pa-* (Travis 2000a; Rackowski 2002)
- c. **Agr** (see chap. 3): Voice morphology; locus of Nominative Case
 - Morphological Realizations: AV *m-/<um>*, PV *-in*, LV *-an*, CV *i-*
 - Correlates with the presence of Nominative Case in verbal constructions (see also McGinn 1988)
- d. **I(nfl)**: Aspect information
 - Morphological Realizations: CV-reduplication, *n-/<in>*
 - Carries [*UPRED*] EPP feature, which derives predicate-initial word order (Massam and Smallwood 1997; Massam 2000)
- e. **C**: Left Periphery (to be expanded in chap. 7)

Chapter 3

On the formal status of *ang*

In the research on Tagalog and other related languages, much discussion and analysis has been devoted over the years regarding the formal status of the pivot and the morphological marking it receives, as well as the inextricably linked issue of the voice system. Some propose, for example, that *ang*-marking is case. Many of these proposals treat (some subset) of the voice system as reflecting alternations in transitivity (i.e., active vs passive/antipassive), so that *ang*-marking spells out nominative Case in a nominative-accusative system (Guilfoyle et al. 1992; Kroeger 1993), or absolutive Case in an ergative system (Aldridge 2004a; de Guzman 1988; Payne 1982). This treatment of *ang* as case can also be found in proposals that eschew the transitivity-alternation-based view of the Tagalog voice system. For example, in the approach put forth by Kaufman (2009), Tagalog has no formal noun-verb distinction, and apparently verbally predicated clauses instead have the structure of nominally predicated ones. Under this view, *ang*-marking is simply the case assigned to the subject of all clauses. On the other hand, some scholars propose that *ang*-marking is formally distinct from case, instead marking some other property such as information-structural topichood (Chen 2017) or the result of a language specific object-shift operation (Rackowski 2002). For these proposals, voice morphology is treated as the result of agreement with the pivot, reflecting specific formal features on the pivot, such as abstract Case.

In this chapter, I present an analysis of *ang*-marking and the pivot that is in some sense a hybrid of these two general approaches. Following the “*ang*-as-case” approaches, I assume that *ang*-marking is the spell-out of abstract (nominative) Case, which licenses DPs (Chomsky 1981 and subsequent works). As primary evidence for this claim, I discuss the behavior of applicative constructions in Tagalog following Rackowski (2002), where I show that the applied object relies on *ang*-marking for licensing.

On the other hand, I follow the “*ang*-as-other” approaches in assuming that the pivot is not the grammatical subject (at least in the classical sense of occupying Spec-IP). Rather, I propose that it is the DP that has undergone movement triggered by the functional head that spells out voice morphology, which I label Agr⁰. In this regard, the present proposal makes conclusions similar to those made by Schachter (1976, 1996). As supporting evidence of this claim, I present evidence showing that the presence of nominative Case in verbal constructions is fully predicted by the presence of Agr⁰ (i.e., voice morphology). In the process, the position of AgrP between IP and *v*P will also be argued for.

This analysis of *ang*-marking as the spell-out of abstract Case is situated in a broader system of Case licensing, which I propose to account for a subset of the underlying case patterns previously discussed in Section 2.4.3. Under this system, non-applied arguments, prominently agents/actors and themes, have independent sources of (non-nominative) Case licensing, but may nevertheless receive nominative Case at some later point in the derivation. I formalize this by adopting Béjar and Massam’s (1999) Multiple Case Checking analysis. Furthermore, the treatment of *ang*-marking proposed here follows the spirit of much previous work showing the divergent behavior in Austronesian languages of Case and phenomena often tied to Case, such as subjecthood, raising, and passives among others (e.g., Chen 2018b; Guilfoyle et al. 1992; Law 2011; Nakamura 2000).

3.1 Voice and nominative

We begin by considering in detail the relationship of *ang*-marking and various morphological alternations exhibited by verbs in Tagalog. I follow a thread of research in Tagalog that draws a formal distinction between two groups of morphemes involved in such alternations, which I will refer to here as voice morphemes and argument-introducing morphemes. We will see that while determining *which* argument in a verbally predicated Tagalog clause bears *ang*-marking is the result of interactions between these morphemes, *whether* a clause bears an *ang*-marked argument in the first place depends solely on the presence of a voice morpheme.

As introduced in Chapter 1, the determination of which dependent in a Tagalog clause receives *ang*-marked pivot status is tied to the particular morphology that appears on the verb—commonly known as Philippine- or Austronesian-type voice morphology. A distinguishing feature of this kind of voice system is that core arguments as well as a broad range of more peripheral clausal dependents can be marked as the pivot. Thus, while English has two main voice forms: active voice for agent subjects and passive voice for themes as well as a few kinds of peripheral theta-roles (see 3b), Tagalog has many more. Some examples are shown in (1-3), with the pivot underlined. I have also provided attempts at putting the relevant argument in subject position in the English free translation for comparison.

(1) TAGALOG VOICE (Root: *bili* ‘buy’)

- a. B<um>ili si Juan ng kape gámit ang barya.
 <AV>buy(PFV) NOM.P Juan GEN coffee use NOM coin
 ‘Juan bought coffee using coins.’ Agent pivot
- b. B<in>ili ni Juan ang kape gámit ang barya.
 <PFV>buy[PFV] GEN.P Juan NOM coffee use NOM coin
 ‘Juan bought the coffee using coins.’
 ≈ ‘The coffee was bought by Juan using coins.’ Theme pivot
- c. I-p<in>am-bili ni Juan ng kape (*gámit) ang barya.
 CV-<PFV>INS-buy GEN.P Juan GEN coffee use NOM coin
 ‘Juan bought coffee using the coins.’
 ≈*‘The coins were bought the coffee by Juan with *t*.’ Instrument pivot

(2) TAGALOG VOICE (Root: *suot* ‘wear, put on’)a. **Nagsu~suot** si Kiko ng shorts.

AV.IMPF~wear NOM.P Kiko GEN shorts

‘Kiko is putting on shorts.’

Agent pivot

b. S<**in**>u~suot ni Kiko ang shorts.

IMPF~wear[PV] GEN.P Kiko NOM shorts

‘Kiko is putting on the shorts.’≈ ‘The shorts are being put on by Kiko.’

Theme pivot

c. S<**in**>u~suot-**an** ni Kiko ang aso ko ng shorts.

IMPF~wear-LV GEN.P Kiko NOM dog 1SG.GEN GEN shorts

‘Kiko puts shorts on my dog.’≈* ‘My dog is being put on *t* shorts by Kiko.’

Goal pivot

(3) TAGALOG VOICE (Root: *usap* ‘talk’)a. **Mag-u~usap** ang mga mag-aarál tungkol sa nobela.

AV-FUT~talk NOM PL AN.study about OBL novel

‘The students will talk about the novel.’

Agent pivot

b. **Pag-u~usap-an** ng mga mag-aarál ang nobela.

pag-FUT~talk-LV GEN PL AN.study NOM novel

‘The students will talk about the novel.’≈ ‘The novel will be talked about by the students.’

“Topic” pivot

Part of the complexity presented by the voice system in Tagalog lies in the mapping between general verb forms and the thematic role picked out to be the pivot. While various broad-strokes generalizations can be made about this mapping (e.g., *mag-* is generally associated with agent pivots) it is not straightforwardly one-to-one. For example, we see in (3b) that marking the verb *usap* ‘talk’ with *pag...-an* as in results in a “topic” (i.e., what is talked/argued/debated/etc. about) as the pivot. This is not always the case, however. We see in (4) that the same morphology on a different verb (i.e., *luto* ‘cook’) can result in a pivot with a different thematic role (i.e., receptacle).¹

(4) **Pag-lu~lutu-an** ko ng tinola ang pula=ng kaldero.

pag-FUT~COOK-LV 1SG.GEN GEN tinola NOM red=LK pot

‘I will cook tinola in the red pot.’≈* ‘The red pot will be cooked *tinola* in by me.’

Receptacle pivot

Conversely, the same (or similar) thematic role may correspond to different voice morphology. For example, theme pivots correspond to at least three distinct verbal forms (marked with *-in*, *-an*, or *i-*) conditioned

¹See Ramos 1974, chap.1 for more discussion. Note also that the relevant topic and receptacle arguments are marked slightly differently when appearing as non-pivots. Although they are both oblique, we see in (3a) that the non-pivot topic appears with a contentful preposition (*tungkol sa nobela* ‘about the novel’), while the non-pivot receptacle appears only with oblique marking (*sa pulang kaldero* ‘in the red pot’) in (5a).

by the root, as shown in (5), whereas (6) shows two possible forms for goal pivots (*ipag-* vs *-an*), again depending on the root.

(5) DIFFERENT MORPHOLOGY FOR THEME PIVOTS

- a. Lu~lutu-**in** ko ang tinola sa pula=ng kaldero.
 FUT~COOK-PV 1SG.GEN NOM *tinola* OBL red=LK pot
 ‘I’m going to cook the tinola in the red pot.’
- b. Bu~buks-**an** ko ang bintana.
 FUT~open-LV 1SG.GEN NOM window
 ‘I’m going to open the window.’
- c. I-su~sulat ko ang pangalan ko.
 CV-FUT~write 1SG.GEN NOM name 1SG.GEN
 ‘I’m going to write my name.’

(6) DIFFERENT MORPHOLOGY FOR GOALS

- a. {**I-pag-lu~luto** /[?]Lu~lutu-**an**} ko ng itlog si Sisa.
 CV-*pag*-FUT~cook FUT~COOK-LV 1SG.GEN GEN egg NOM.P Sisa
 ‘I will cook eggs for Sisa.’
- b. {***I-pag-bi~bili** /Bi~bilh-**an**} ko ng tsokolate si Sisa.
 CV-*pag*-FUT-buy FUT~buy-LV 1SG.GEN GEN chocolate NOM.P Sisa
 ‘I will buy chocolate for Sisa.’

This complexity has resulted in a number of different approaches (especially in earlier work) to the categorization or labeling of Tagalog voice alternations, drawing on information such as verbal morphology, fine-grained distinctions regarding the theta-role of the pivot, and the lexical semantics of the verb root (Cruz 1975; McFarland 1976; Schachter and Otnes 1972; see also Klimenko and Endriga 2016 for recent work supported by more quantitative methods). This thesis will ultimately not have much to add to the research on the full complexity of the Tagalog voice alternations. Instead, I focus here on the distinct roles that can be attributed to specific subsets of the morphology involved in the Tagalog voice system. The remainder of this section is devoted to the discussion of these roles.

3.1.1 The morphology of the voice system

The verbal morphology that is involved in the Tagalog voice system broadly construed can be separated into two classes. The first class consists of the Tagalog reflexes of the Proto-Austronesian voice morphology. I refer to these here as the VOICE MORPHEMES, and follow previous work by McGinn (1988) in arguing that the presence of nominative marking in a verbally predicated construction is intrinsically tied to their presence (Sec. 3.1.2). The voice morphemes contrast with the second class of morphemes, which previous work has argued to have argument introduction as a primary function (Rackowski 2002; Travis 2000a,b).

As shown at the beginning of this section, these two classes of morphemes often interact in complex ways.

3.1.1.1 Class 1: Voice morphemes

One of four morphemes always appears on any voice-marked verb: *m-/um>*, *-in*, *-an*, and *i-*, as shown in (7). These are the reflexes of the Proto-Austronesian indicative/realis series voice morphemes, **<um>*, **-en*, **-an*, and **Si-/Sa-* (Chen 2017, p.9; Ross 2002 cited in Ross 2009, p.296).

- (7) a. Bum-i~bili ako ng tsokolate.
 AV.IMPF~buy 1SG.NOM GEN chocolate
 ‘[I’m buying/I buy] chocolate.’ Agent pivot → *<um>*
- b. Bi~bilh-in ko ang tsokolate.
 FUT~buy-PV 1SG.GEN NOM chocolate
 ‘I will buy the chocolate.’ Theme pivot → *-in*
- c. Bi~bilh-an ko ng tsokolate si Sisa.
 FUT~buy-LV 1SG.GEN GEN chocolate NOM.P Sisa
 ‘I will buy Sisa the chocolate.’ Goal pivot → *-an*
- d. I-pa~pa-bili ko kay Crispin ang tsokolate.
 CV-FUT~CAUS-buy 1SG.GEN OBL.P Crispin NOM chocolate
 ‘I will make Crispin buy the chocolate.’ Theme pivot (in causative) → *i-*

I refer to these morphemes as AV (Agent/Actor Voice), PV (Patient Voice), LV (Locative Voice), and CV (Conveyance/Circumstantial Voice). These names generally encapsulate the thematic roles most commonly associated with the pivots in clauses that these morphemes appear in, and examples showing these thematic roles are discussed below. We have seen, however, that the association between morphology and pivot thematic role is complex, being sensitive to properties of the root and, as will be discussed in the next subsection, other verbal morphology. With this in mind, it is worth stating explicitly that I use these labels primarily to refer to the morphemes themselves, rather than to a broader notion of a “voice form” that takes into account the thematic role of the pivot (e.g., Schachter and Otnes’s (1972, §5.10) Referential Voice, Measurement Voice, etc.). I opt to use abbreviations to refer to these morphemes to help avoid potential confusion.

AV is generally used when an external argument (e.g., agent, experiencer, causer, etc.) is marked as the pivot. AV is also often used for many (but not all) intransitives.² Some examples showing a small range of environments where AV is used are in (8).

²To a first approximation, the relevant property determining this appears to be whether a verb is unergative or unaccusative, with the former tending to bear *<um>* as in (8c) and the latter tending to bear *ma-* (e.g., *ma-hulog* ‘to fall’) in their respective aspectless forms. However, this generalization is far from perfect. Furthermore, questions can be raised about *ma-*. While it does bear the characteristic *m-* found in AV marking, the *ma-* morpheme itself is found in other contexts, notably all non-AV non-volitional forms (see e.g., Table 2.2). For further discussion of intransitivity as it relates to Philippine-type voice and argument marking, see Chen 2017, chap.3.

- (8) a. **Mag-lu~luto** si Armando ng sinigang.
 AV.pag-FUT~COOK NOM.P Armando GEN sinigang
 ‘Armando will cook *sinigang*.’ Agent pivot
- b. **Mag-pa~pa-luto** si Armando ng sinigang sa kusinero.
 AV.pag-FUT~CAUS-COOK NOM.P Armando GEN sinigang OBL chef
 ‘Armando will have the chef cook *sinigang*.’ Causer pivot
- c. T<**um**>a~tahol ang aso.
 AV.IMPF~bark NOM dog
 ‘The dog is barking.’ Intransitive (Unergative) pivot

PV is typically associated with theme pivots—particularly those of a large number of monotransitive verbs like in (9a)—and with causee pivots (9b).

- (9) a. **Lu~lutu-in** ni Armando ang sinigang.
 FUT~COOK-LV GEN.P Armando NOM sinigang
 ‘Armando will cook the sinigang.’ Transitive theme pivot
- b. **Pag-lu~lutu-in** ni Armando ang kusinero ng sinigang.
 pag-FUT~COOK-LV GEN.P Armando NOM chef GEN sinigang
 ‘Armando will have the chef cook *sinigang*.’ Causee pivot

LV is commonly used when the pivot has a generally location-like role such as goal, source, or location (10a-b), but it is also used with some theme pivots that arguably have some kind of locative interpretation to them, as in (10c) and possibly (5b).

- (10) a. **Pag-lu~lutu-an** ni Armando ng sinigang ang pula=ng kaldero.
 pag-FUT~COOK-LV GEN.P Armando GEN sinigang NOM red=LK pot
 ‘Armando will cook *sinigang* in the red pot.’ Receptacle pivot
- b. **Tu~turu-an** ni Lisa ang mga mag-aarál ng syntax.
 FUT~teach-LV GEN.P Lisa NOM PL student GEN syntax
 ‘Lisa will teach the students syntax.’ Goal pivot
- c. **La~labh-an** ni Carlo ang mga kumot.
 FUT~launder-LV GEN.P Carlo NOM PL blanket
 ‘Carlo will wash the blankets.’ Theme pivot

Finally, CV is something of an elsewhere case, although there are a few notable types of thematic roles that this morpheme is associated with. Particularly, it has been noted that CV is commonly used with pivot themes that have undergone some kind of movement or displacement, as shown by (11a-b) (and potentially also (5c)), hence the label “conveyance” (Himmelmann 2005). CV is also used when a causative theme (11c) or an instrument (11d) is the pivot.

(12) CAUSATIVE *pa-* (see Schachter and Otnes 1972; Rackowski 2002)

- a. Mag-lu~luto si Lilet (*sa akin) ng itlog.
 AV.pag-FUT~cook NOM.P Lilet OBL 1SG.OBL GEN egg
 ‘Lilet will cook some egg(s).’ Monotransitive agent pivot → *m-* + *pag-*
- b. Mag-pa~**pa**-luto si Lilet **sa** **akin** ng itlog.
 AV.pag-FUT~CAUS-cook NOM.P Lilet OBL 1SG.OBL GEN egg
 ‘Lilet will make/have me cook the egg(s).’ Causative agent (causer) pivot → *m-* + *pag-* + *pa-*

Both examples in (12) feature the AV morpheme *m-* on the verb, and have the highest external argument as the pivot, thus highlighting the argument-introducing function of *pa-*. However, this morpheme interacts with the voice morphemes (i.e., Agr⁰) in specific ways. For example, while theme pivots of transitives usually require PV, they require CV in the corresponding causative construction, as shown in (13).

(13) VOICE MORPHEMES FOR CAUSATIVE VS NON-CAUSATIVE THEMES

- a. Lu~lutu-**in** ni Lilet ang itlog.
 FUT~cook-PV GEN.P Lilet NOM egg
 ‘Lilet will cook the egg(s).’ Monotransitive theme pivot → *-in*
- b. I-pa~**pa**-luto ni Lilet sa akin ang itlog.
 CV-FUT~CAUS-cook GEN.P Lilet OBL 1SG.OBL NOM egg
 ‘Lilet will make/have me cook the egg(s).’ Causative transitive theme pivot → *i-*

Similar behavior can be observed with the prefix *pag-*. In (14), we see that this morpheme is involved in the change from intransitive/inchoative to transitive forms of the root *babâ* ‘down’. (14a) shows that *bumaba* is strictly intransitive, with its sole argument (the passenger) being the entity undergoing the action of going down (or, specifically, alighting from a vehicle). On the other hand, *nagbabâ* in (14b) has an additional argument (the driver) corresponding to the entity that causes the action of going down. Note that the intransitive form cannot appear with a causer argument, nor can the pivot be interpreted as a causer.

(14) EA-INTRODUCING/LEXICAL CAUSATIVE *pag-* (Rackowski 2002; Travis 2000a)

- a. B<um>aba (*ng tsuper) ang pasahero (*ng gámit).
 <AV>down(PFV) GEN driver NOM passenger GEN thing
 ‘The passenger alighted (from the vehicle).’
 Not: ‘The driver let the passenger off (the vehicle).’
 Nor: ‘The passenger brought things down/off (the vehicle).’
- b. **Nag**-babâ ang tsuper ng pasahero.
 AV.PFV.pag-down NOM driver GEN passenger
 ‘The driver let a passenger off (the vehicle).’ *nag-* = *n-* + (*m-* +) *pag-*

The examples above attempt to highlight the argument-introducing function of these morphemes as a behavior separate from the voice system, but in fact, these morphemes interact significantly with the voice morphemes. This interaction can occur in systematic ways, but it can also appear rather opaque. For example, while pivot themes of transitives usually require PV, they require CV in the corresponding causative construction, as shown in (13).

As with *pa-*, the presence of *pag-* interacts with the rest of the voice system, as (15) shows. In these cases, the interactions tend to be more complex and more sensitive to the properties of the verbal root. Often, the result is that peripheral arguments such as goals and “topics”, as we have previously seen, surface as pivots. Examples of other morphemes that exhibit similar behavior are *paN-* and *ka-* in (16).⁵

(15) VOICE MORPHEMES WITH *pag-*

- a. **I-pag-lu~luto** ko ng itlog si Sisa.
 CV-*pag-FUT~cook* 1SG.GEN GEN egg NOM.P Sisa
 ‘I will cook eggs for Sisa.’ Goal pivot → *i-pag-*
- b. **Pag-u~usap-an** natin ang thesis ni Chomsky.
pag-FUT~speak-LV 1PL.INCL.GEN NOM thesis GEN.P Chomsky
 ‘We will be talking about Chomsky’s thesis.’ “Topic/Reference” pivot → *pag-...-an*

- (16) a. **I-p<in>am-bili** ni Basilio ng libro ang una=ng sweldo niya.
 CV-<PFV>INS-buy GEN.P Basilio GEN book NOM first=LK wage 3SG.GEN
 ‘Basilio bought books with his first paycheck.’ Instrument pivot → *i-paN-*
- b. **K<in>amu~muhi-an** ni Sisa ang mga uwak na iyon.
ka.IMPF~hate-LV GEN.P Sisa NOM PL crow LK DIST
 ‘Sisa hates those crows.’ Cause/Reason pivot → *ka-...-an*

There is fairly strong precedent for treating morphemes like *pag-*, *paN-*, *pa-*, etc. as heading projections that introduce and/or license arguments (e.g., Rackowski 2002; Travis 2000a). I will follow this precedent, assuming concretely that these morphemes are different types of v^0 or AppI^0 , introducing arguments as specifiers of their respective phrases. The interactions between v^0/AppI^0 and Agr^0 (the voice morphemes) in the Tagalog voice system are complex, and merit in-depth study in their own right (see Cruz 1975; McFarland 1976; Ramos 1974), but for present purposes, it is sufficient to formally distinguish these categories, as they behave differently with respect to how Case licensing in this language is carried out.

3.1.2 Agr^0 as the locus of nominative

We have seen so far that in a typical Tagalog clause, there is one dependent marked as the pivot, and which dependent bears such marking is closely tied to the voice system. That is, voice morphology co-

⁵The interactions between the argument-introducing morphemes and the voice morphemes is often opaque enough that it is relatively common (especially in teaching materials) to treat affix clusters such as *ipag-*, *pag-...-an*, *ka-...-an* as single or indivisible units.

varies with the argument marked *ang* (i.e., nominative). In this section, I discuss the relationship between voice morphology and *ang*-marking from a different angle: that of co-occurrence. Specifically, we will see that while the co-variance between voice morphology as a whole and the thematic role of the pivot is rather complex, the actual *occurrence* of a pivot argument (and equivalently, *ang*-marking) can be clearly tied to a subset of the voice morphology: the voice morphemes that spell out Agr⁰.

McGinn (1988) points out a stronger link between voice and *ang* than mere co-variance: the presence of a pivot in a verbally predicated clause is in fact dependent on the presence of a voice morpheme on the verb. He presents two kinds of voiceless environments, gerunds and the recent perfective construction, to support this claim. In these constructions, none of the realizations of Agr⁰ (i.e., *m- / <um>*, *-in*, *-an*, and *i-*) surface, and none of the dependents bear *ang*. An example of a gerund (which we saw briefly in Sec. 2.4.3) and a recent perfective are given in (17). I have also included another construction (17c), which is morphologically identical to the recent perfective, but (at least apparently) has a different use.

(17) VOICELESS ENVIRONMENTS; NO PIVOT

- a. (ang) pagbi~bigay ko ng bigas kay Sisa
 NOM pag.RED~give 1SG.GEN GEN rice OBL.P Sisa
 ‘my giving of rice to Sisa’ Gerund
- b. {Kaka-bigay / Kabi~bigay} ko lang ng bigas kay Sisa.
 RPFV-give RPFV~give 1SG.GEN only GEN rice OBL.P Sisa
 ‘I have just given rice to Sisa.’ Recent Perfective
- c. Na-pagod ang babae sa {kaka-laro / kala~laro} niya ng basketball.
 PFV-tire NOM woman OBL ka.RED-play ka.RED~play 3SG.GEN GEN basketball
 ‘The woman got tired from all her playing of basketball.’ *sa kaka-* construction

Before we proceed, it is important to note that the generalizations discussed here specifically apply to *verbally* predicated constructions. Non-verbally predicated clauses (e.g., NPs, PPs, AdjPs) do not show the reflexes of Agr⁰ discussed in the previous section. In fact, they do not bear *any* of the morphology discussed so far (*v*⁰, AppI⁰, Agr⁰, I⁰). Nevertheless, clauses with such predicates generally still have *ang*-marked pivots, as we have seen (e.g., in Sec. 2.2). I will set this class of clauses aside for the time being, and return to them in Section 3.5.

The data in (17) is compatible with Agr⁰ being the source of *ang*-marking, but these examples also lack marking for aspect.⁶ Thus, we must still rule out the possibility that I⁰, the head spelling out aspect (as assumed in Sec. 2.3), is the source of *ang*-marking.

Unlike in languages where nominative Case comes from T⁰/I⁰, *ang*-marking in Tagalog is not affected by tense/aspect specification on the verb. In particular, *ang*-marking is available even in aspectless clauses. As introduced in Section 2.3, the aspectless form is morphologically realized as the absence of aspect-marking morphology on the verb (i.e., no *n- / <in>* nor CV-reduplication), and is mostly used in

⁶As discussed in Sec. 2.3.1, I assume that the Recent Perfective form is not formally marked for aspect. However, the main point of this section, that Agr⁰ is the locus of *ang*-marking, should hold regardless of the status of RPFV with respect to the rest of the aspectual system, as RPFV forms are not the only evidence provided. Indeed, McGinn (1988) argues for this position even though he assumes that RPFV is an aspectual form.

dependent-like clauses, such as complements of control verbs. I take these two properties as evidence that I^0 is either absent or defective in this form. Some examples are given in (18). In all these cases, we see that the aspectless clauses (bracketed) all have an *ang*-marked dependent (underlined) as well as an exponent of Agr^0 (boldface).⁷

(18) ASPECTLESS (BUT VOICE-MARKED) ENVIRONMENTS

- a. <In>utus-an niya ako=ng [bigy-**an** ng bigas si Sisa].
 <PFV>command-LV 3SG.GEN 1SG.NOM=LK give-LV GEN rice NOM.P Sisa
 ‘She ordered me to give rice to Sisa.’ Control complement
- b. Hangárin ni Kiko ang [**mag-áral** ang anak niya ng medisina].
 hope.PN GEN.P Kiko NOM AV-study NOM child 3SG.GEN GEN medicine
 ‘For his child to study medicine is Kiko’s hope.’ Nominalized aspectless clause
- c. B<um>alik si Helen sa paaralan upang [kun-**in** ang diploma niya].
 <AV>return(PFV) NOM.P Helen OBL school in.order.to take-PV NOM diploma 3SG.GEN
 ‘Helen returned to the school in order to get her diploma.’ Purpose clause
- d. [Hindi ko ma-bigy-**an** ng bigas si Sisa].
 NEG 1SG.GEN NVOL-give-LV GEN rice NOM.P Sisa
 ‘I {can’t/am unable to} give rice to Sisa.’ Negated ability (non-volitional form)
- e. [Bigy-**an** mo ng bigas si Sisa].
 give-LV 2SG.GEN GEN rice NOM.P Sisa
 ‘Give rice to Sisa.’ Imperative

Note in particular the biclausal examples (18a-c). These examples have two *ang*-marked dependents, one in the matrix clause and one in the dependent aspectless clause. Assuming that *ang*-marking is limited to at most one per clause, these examples show that *ang*-marking in the dependent clause cannot be treated as originating from the matrix clause. Thus, aspectless clauses must independently have a source of *ang*-marking.

The data we have seen with respect to voice (Agr^0), aspect (I^0), and the availability of *ang*-marking is summarized in Table 3.1. Given this data, I conclude that the functional head assigning *ang*-marking (i.e., nominative) on pivots in Tagalog must be Agr^0 .

Table 3.1: Availability of *ang*-marking with respect to Aspect and Voice marking

Agr^0	I^0	NOM	e.g.,
✓	✓	✓	Independent declarative (verbal) clauses
✓	✗	✓	Control complements, imperatives, purpose clauses (18)
✗	✗	✗	Gerunds, recent perfective (17)

⁷McGinn (1988) points out such behavior as well, but limits his discussion to control- and tough-movement-like constructions, which he assumes have a PRO in their agent/external argument positions. As I show here, aspectless verbs have a more general distribution.

Concretely, I propose that Agr⁰ in Tagalog is generated below I⁰ but above the argument-structure-altering heads (*v*⁰/AppI⁰). Motivation for this relative hierarchy comes from the distribution of functional heads across verbally derived constituents of various sizes. Across different types of verbal constructions, we find an implicational hierarchy with respect to what kinds of morphemes appear on the verbal heads. If the verb is marked for aspect, then it is also marked for voice, and may also bear argument-structure-altering heads if relevant.

(19) IMPLICATIONAL HIERARCHY IN TAGALOG VERBAL MORPHEMES

$$\begin{array}{ccccc} I^0 & < & Agr^0 & < & v^0/ AppI^0 \\ \text{(Aspect)} & & \text{(Voice)} & & \text{(Arg. Structure)} \end{array}$$

Some examples showing this implicational hierarchy are provided below in (20-22). I provide morphological decompositions of the affixal morphology to the right of each example, and I identify the morphemes with their corresponding syntactic heads through formatting. Aspectual morphology is underlined, the voice morphemes are boxed, and the argument structure morphemes are given wavy underlines.

First, we see examples (20) where all three types of morphemes co-occur.⁸

(20) ASPECT + VOICE + ARGUMENT STRUCTURE

- a. **I-p<in>a-basa** ko sa mga mag-aarál ang artikulo.

CV-<PFV>CAUS-read 1SG.GEN OBL PL AN.study NOM article

'I had the students read the article.'

i- + <in> + pa- → *ipinabasa*

- b. Nakaka-tuwa yung [tuwing **nakiki-pag-laro** sa akin ang pusa ko].

IMPF-be.pleased NOM whenever AV.SOCIAL.IMPF-pag-play OBL 1SG.OBL NOM cat 1SG.GEN

'It {is pleasing/makes one happy} whenever my cat plays with me.'

n- + m- + paki- + CV- + pag- → *nakikipaglaro*

(see Schachter and Otones 1972, §5.14)

Next, (21) shows environments where argument structure and voice morphemes can occur, but not aspect morphology. Compare the grammatical verb in boldface, which is aspectless, to the ungrammatical verb, which is marked for future aspect.

(21) ASPECT + VOICE + ARGUMENT STRUCTURE

- a. Ma-ganda=ng [{**i-pa-basa** /*i-pa~pa-basa } sa mga mag-aarál ang artikulo=ng ito].

ADJ-nice=LK CV-CAUS-read CV-FUT~CAUS-read OBL PL AN.study NOM article=LK PROX

'This article is good (for us) to have the students read.'

i- + pa- → *ipabasa*

⁸Recall from Section 2.3 that the non-AV perfective and imperfective forms are marked with an infix <in>. The infixes in Tagalog appear following the first consonant of the stem they attach to. As *i-p<in>a-basa* in (20a) shows, this stem may be morphologically complex. Following McCarthy and Prince (1990, p.227), I represent <in> formally as a prefix in the provided morphological decomposition.

- b. <In>utus-an ako ng guro=ng [{**maki-pag-laro** /*makiki-pag-laro } sa mga
 <PFV>command-LV 1SG.NOM GEN teacher=LK AV.SOCIAL-pag-play AV.FUT.SOCIAL-pag-play OBL PL
 kaklase ko].
 classmate 1SG.GEN

‘The teacher told me to play with my classmates.’ $\overline{m-} + \underline{paki-} + \underline{pag-} \rightarrow \underline{makipaglaro}$

Finally, in (22) we have examples that bear only argument structure morphemes, and no aspect or voice morphemes. Again, compare the grammatical examples in boldface, to the ungrammatical examples that are marked with voice or aspect, here AV and future aspect.

(22) ASPECT + VOICE + ARGUMENT STRUCTURE⁹ (see also Schachter and Otnes 1972, §3.26)

- a. T<in>igil-an na nila ang [{**pag-pa~pa-basa** /*mag-(pa~)pa-basa } (nila) sa mga
 <PFV>stop-LV already 3PL.GEN NOM pag-RED~CAUS-read AV.pag-FUT~CAUS-read 3PL.GEN OBL PL
 mag-aarál ng artikulo=ng ito].
 AN.study GEN article=LK PROX

‘They have stopped (their) having the students read this article.’ $\underline{pag-} + \underline{pa(pa)-} \rightarrow \underline{pagpapabasa}$

- b. Na-tuwa ang guro sa [{**pakiki-pag-laro** /*maki(ki)-pag-laro } ko sa mga
 PFV-be.pleased NOM teacher OBL SOCIAL-pag-play AV.SOCIAL(.FUT)-pag-play 1SG.GEN OBL PL
 kaklase ko].
 classmate 1SG.GEN

‘The teacher was pleased with my playing with my classmates.’

$\underline{paki(ki)-} + \underline{pag-} \rightarrow \underline{pakikipaglaro}$

I assume that wherever morphology is absent, the relevant functional head is also either absent or defective. Thus, the examples in (21) have a missing or defective I⁰, while for the ones in (22), the missing/defective heads are I⁰ and Agr⁰. Notice again that the presence of an *ang*-marked pivot is contingent on the presence of voice marking on the verb; compare (20-21) with (22). Note that in (21b), the *ang*-marked dependent of *makipaglaro* is the agent, which is a controlled PRO.

Having established a strong link between Agr⁰ and *ang*-marking on pivots, a major question that must now be addressed is what *ang*-marking itself is, formally, and how it comes to be assigned to the pivot. I turn to this issue in the next section, where I present an analysis of *ang* as the spell-out of abstract nominative Case.

⁹Note that CV-reduplication appears in gerunds, sometimes obligatorily. Schachter and Otnes (1972, p.160) tie the presence of reduplication in gerunds to whether or not an EA-introducing morpheme is present in the corresponding non-gerund form. Thus, for them, the gerund form of *maglaro* ‘play (AV)’, which contains *pag-*, is *paglalaro* ‘playing’, not **paglaro*, while for *uminom* ‘drink (AV)’ the gerund form is *pag-inom* ‘drinking’, not **pag-iinom*. Alternatively, we might adopt Travis’s (2000a) treatment of CV-reduplication in Tagalog as inner aspect, having a position structurally lower than some argument-introducing projections. As far as I can tell, both approaches are compatible with the broader analysis proposed in this dissertation.

3.2 *Ang* as Case

I begin this section by discussing some apparently non-Case-like behavior of *ang*-marking, which appears on Tagalog pivots. Such behavior is consistent with existing analyses that maintain that *ang* does not mark Case (Chen 2017; Rackowski 2002; Richards 2000, a.o.). Despite this, I argue for and develop a Case-based treatment of *ang*-marking in this section, based on a proposal by Béjar and Massam (1999) and drawing parallels to cross-linguistic phenomena such as case stacking to show that this approach is at least compatible with the apparently non-Case-like behavior we see. In the next section, I present evidence showing that *ang*-marking licenses nominals, and that it therefore *must* be treated as Case.

Recall from Section 2.4.3 that Tagalog exhibits a strong link between the thematic role of a nominal and the marking that it receives, but that this was only true when we ignored the distribution of *ang*-marking. We have since seen, in the previous section, that the distribution of *ang*-marking contrasts with that of the other markers in that it is linked to Agr⁰, which I proposed to be the functional head hosting the Tagalog voice morphemes (following McGinn 1988). Furthermore, we briefly saw that *ang*-marking seems to “replace” the underlying thematically linked marking. We can see this replacement most clearly by comparing constructions that assign *ang*-marking to parallel constructions that do not, as in the examples below. In (23) we see that transitive agents receive genitive, while themes receive genitive or oblique, depending on definiteness. Compare this with (24), where we see that this case marking is replaced by *ang/si* on pivots, but preserved for non-pivot arguments: the theme in AV (24a) is still genitive/oblique, and the agent in PV (24b) is still genitive.¹⁰

(23) ENVIRONMENTS WHERE NO *ang* IS ASSIGNED

- a. (ang) pag-kagat ng lamok {ng tao /kay Sisa}
 NOM pag-give GEN mosquito GEN person OBL.P Sisa
 ‘the mosquito’s biting of {a person/Sisa}’ Gerund
- b. Kaka~kagat lang ng lamok {ng tao /kay Sisa}.
 RPFV~bite only GEN mosquito GEN person OBL.P Sisa
 ‘The mosquito has just bitten {a person/Sisa}.’ Recent Perfective

(24) ENVIRONMENTS WHERE *ang* IS ASSIGNED

- a. K<um>a~kagat ang lamok {[√]ng tao /[?]kay Sisa}.
 AV.IMPF~bite NOM mosquito GEN person OBL.P Sisa
 ‘The mosquito bites {people/Sisa}.’ AV

¹⁰(24a) has the slight complication that definite themes are degraded, if not ungrammatical, when they are not the pivot in a voice-marked declarative clause. This restriction is inactive in certain contexts, such as in relative clauses targeting the agent. Compare (24a) to (i). For more detailed discussion, see Latrouite 2012 on factors that interact with differential object marking in Tagalog, and Sabbagh (2016) on definiteness vs specificity of objects.

(i) K<in>ain ng palaka ang lamok na [k<um>agat {[√]ng tao /[√]kay Sisa}].
 <PFV>ate[PV] GEN frog NOM mosquito LK <AV>bite(PFV) GEN person OBL.P Sisa
 ‘A frog ate the mosquito that bit {a person/Sisa}.’

b. K<in>a~kagat ng lamok {ang tao /si Sisa}.

IMPF~bite(PV) GEN mosquito NOM person NOM.P Sisa

'The mosquito bites {the person/Sisa}.'

PV

Let us first focus on the behavior of *ang-* and *ng-*marking, setting aside the behavior of oblique-marked (*sa*) phrases, which we will return to in Section 3.3. In both of the examples in (24), *ang-*marking appears on a nominal which has already received (inherent) genitive Case in its thematic position, following the assumptions in Section 2.4.3. Assuming that *ang* is also an instance of Case thus gives us behavior that goes against traditional treatments of Case that assume a one-to-one relationship between nominals and Case, specifically holding that nominals may only be assigned a single value of Case in a derivation (e.g., the Case Filter and variations thereof).

One way we might resolve this conflict is by proposing that Case is not in fact being assigned more than once. For example, we might posit that the conditions for assigning genitive Case to the agent are not present in an AV sentence like (24a). This is the approach commonly taken by scholars who view the voice system in Tagalog as a system of transitivity alternations (e.g., active-(anti)passive) in line with the more cross-linguistically typical conception of the term "voice". I do not pursue such an approach here, and argue against its adoption in Tagalog in Section 3.4.2. Instead, I follow the broad thread of research on Case that challenges the idea of a strict one-to-one relationship between nominals and Case, and proposes that Case assignment may apply to a single nominal multiple times (see Baker and Vinokurova 2010; Béjar and Massam 1999; Chen 2018b; Merchant 2006 and references therein). Thus, I propose that pivots in Tagalog do receive both *ang* and the underlying Case value (if any), adopting Béjar and Massam's (1999) analysis of Multiple Case Checking (MCC).

Béjar and Massam's analysis accounts for phenomena in languages like Hungarian, Icelandic, Niuean, and Norwegian, where nominals are proposed to participate in abstract Case checking multiple times in certain syntactic environments. Their analysis proposes a modification for the classical approach to Case, under which abstract Case is assigned to DPs by functional heads via Agree in narrow syntax, and is subsequently spelled out as morphological case at PF. Under this classical approach, assigning multiple instances of abstract Case to a DP is ruled out. Concretely, Béjar and Massam discuss Chomsky's (1995) analysis, pointing out that multiple instances of abstract Case on a DP would lead to multiple corresponding phonological case features. Such configurations are problematic, because not all of the phonological case features can be spelled out, therefore violating Full Interpretation, which is a general condition that requires all symbols (e.g., phonological features) in a syntactic derivation to have an interpretation (i.e., a pronunciation) at the relevant interface (i.e., PF). Under this formulation, the multiple Case constructions analyzed by Béjar and Massam are problematic, as they incur such violations of Full Interpretation.

In the languages that Béjar and Massam (1999) consider, syntactic environments such as ECM exist where a DP can be shown to have occupied more than one Case-position within a derivation, as in the Niuean sentences in (25). (25a) shows that the subject of the embedded clause is marked absolutive in its base position by virtue of being the subject of the intransitive verb *momohe* 'sleep'. On the other hand, (25b), shows that the embedded subject may also raise out of the embedded clause, whereupon it is marked with the so-called "middle" Case. Béjar and Massam note that the two examples in (25) are indeed related by movement, and not by some other mechanism such as pronoun resumption. We

therefore have a situation where the embedded subject in (25b) must have already received absolutive Case from originating as the subject of the embedded verb, yet is nevertheless able to receive middle Case in the higher position.¹¹

(25) NIUEAN MULTIPLE CASE CHECKING

(Béjar and Massam 1999, ex.3)

a. Manako a ia ke momohe [e na tama].
 want ABS he SUBJ sleep ABS pair child
 ‘He wants the two children to sleep.’

b. Manako a ia [ke he na tama]_i ke momohe *t_i*.
 want ABS he MIDDLE pair child SUBJ sleep
 ‘He wants the two children to sleep.’

Such patterns stand in contrast to the English-like pattern, where DPs must receive Case exactly once. For example, one traditional account for why English allows raising out of non-finite complements of raising verbs but disallows the same for finite ones is because non-finite I⁰ does not assign Case, while finite I⁰ assigns nominative to its specifier. Thus, as illustrated in (26), raising of the embedded subject to the matrix subject position is allowed out of non-finite clauses, where the movement chain is only assigned Case once. In contrast, raising cannot happen out of finite clauses, as the movement chain would receive Case twice.

(26) a. [The children]_i seem [*t_i* to be sleeping].

(NOM)

(NO CASE)

b. *[The children]_i seem [(that) *t_i* are sleeping].

(NOM)

(NOM)

To account for the Niuean-like pattern, Béjar and Massam propose that a DP can receive more than one abstract Case, and that in languages with MCC, Case on a DP is only PF-interpretable when it is in a checking configuration with the head assigning the Case. Thus, in a language like Niuean, a movement chain can have different Case values assigned to different segments, resulting in Case being “left behind” by a moving DP, intuitively speaking. The result of this movement is shown in the tree (27). Under this proposal, the violation of Full Interpretation discussed earlier is avoided in derivations with MCC because a(n overt) DP only bears the final abstract Case feature assigned to it, with its (unpronounced) traces bearing any previously assigned values of Case. In contrast, languages like English that disallow MCC do not have the condition on the PF-interpretability of Case, so MCC still violates Full Interpretation.¹²

¹¹We also have no independent evidence, at least in this pair of examples, that absolutive Case is unavailable in the embedded clause of (25b). In particular, both embedded clauses in (25) are identical in form, modulo the presence/position of the embedded subject.

¹²Béjar and Massam (1999) also propose that languages can differ on whether a language spells out *all* Case values assigned to a movement chain or only the one assigned to the head of the chain. They propose that Norwegian and Niuean, respectively, instantiate these behaviors. In Norwegian, MCC is possible, but only if the raised DP is a proper name or the second person plural pronoun *dere*, neither of which distinguish morphologically between nominative and accusative case. Thus, nominative and accusative can be valued in a single movement chain, but the result is well-formed only if both Case values can be spelled out.

(27) MULTIPLE CASE CHECKING CONFIGURATION

(adapted from Béjar and Massam 1999, ex.17)

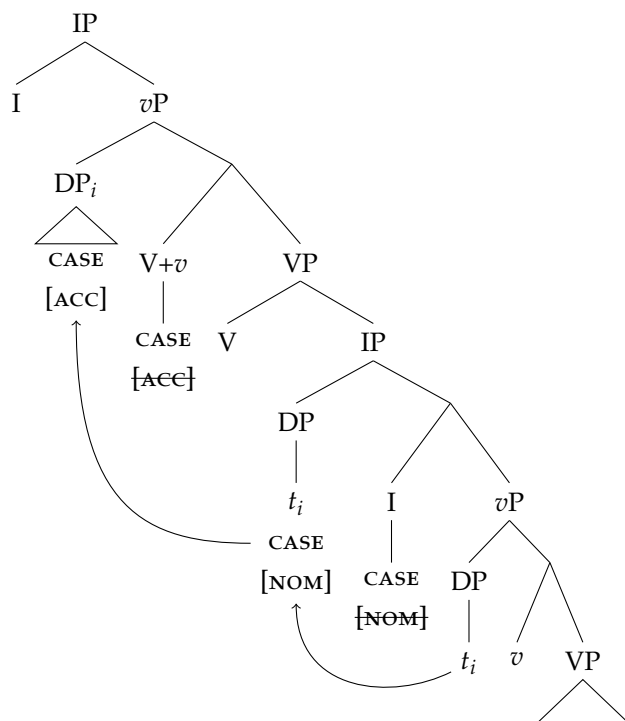

I propose that syntactic configurations parallel to the one in (27) are also a regular occurrence in Tagalog, and that these account for the case alternations that accompany the voice alternations found in this language. Specifically, I posit that core argument DPs in Tagalog are assigned abstract Case in two positions when they surface as the pivot of a clause: lower in their theta-positions and higher in Spec-AgrP. I formalize this in the following way.

First, I assume following the discussion in Section 2.4.3 that core arguments are assigned abstract inherent Case in their base thematic positions. (28) illustrates this for a transitive clause. More concretely, I assume that V^0 assigns inherent genitive Case to the theme in its complement, while agentive v^0 assigns inherent genitive Case to the agent in its specifier.¹³ These abstract Case values are assigned upon Merge of the relevant syntactic head with the argument DP, and are what we see spelled out as morphological case in recent perfective and gerunds, as we saw in (23), as well as on non-pivot DPs in voice-marked clauses, as we saw in (24). In later sections, we will see other possible configurations.

¹³The analysis of Tagalog genitive Case as an instance of inherent Case is interesting to consider in the context of discussion from Woolford (2006), on the distinction between structural and non-structural Cases on one hand, and within the non-structural Cases, lexical and inherent Cases. While genitive Case in Tagalog fits with the intuitive criterion of being associated with the assignment of a theta-role, it does not seem to behave like inherent Case under some of the diagnostics that Woolford provides, particularly those that involve the preservation of Case under certain kinds of movement. Here, there is a question as to what implications the adoption of Béjar and Massam's (1999) MCC analysis has for these diagnostics. Furthermore, the assignment of inherent genitive Case by V^0 to its complement goes against a distributional split proposed by Woolford, whereby lexical Case is only available from truly lexical heads such as V^0 , and inherent Case is only available from more functional heads like v^0 . These raise interesting questions about the status of genitive Case in Tagalog and what it can tell us about Case Theory in general. However, for practical reasons, these questions must be set aside for future work.

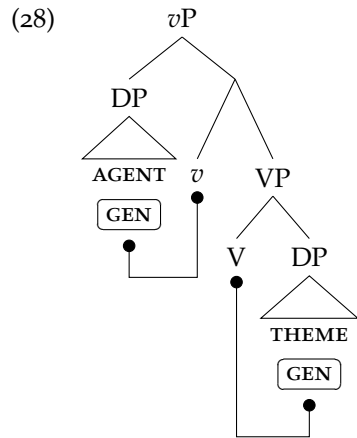

Subsequently, Agr^0 merges into the structure and triggers movement of the pivot to Spec-AgrP. I formalize this by assuming that some DP in the structure is predetermined as the pivot, and bears a discourse-motivated [PIVOT] feature. Consequently, this feature is probed for by a [μ PIVOT] feature on Agr^0 , triggering movement to Spec-AgrP. I assume that [PIVOT] only appears on DPs, and which DP it appears on is determined chiefly by information structural considerations, following the intuition that the pivot is generally what a particular clause is about (for discussion see, e.g., Carrier-Duncan 1985; Chen 2017, chap.4; Kroeger 1993, chap.3; Richards 2000). Thus, in our example in (28), this feature may appear on either the agent or the theme. The two possibilities are shown in (29), corresponding to the AV and PV examples in (24).

(29) a. AV \rightarrow AGR^0 TARGETS AGENT

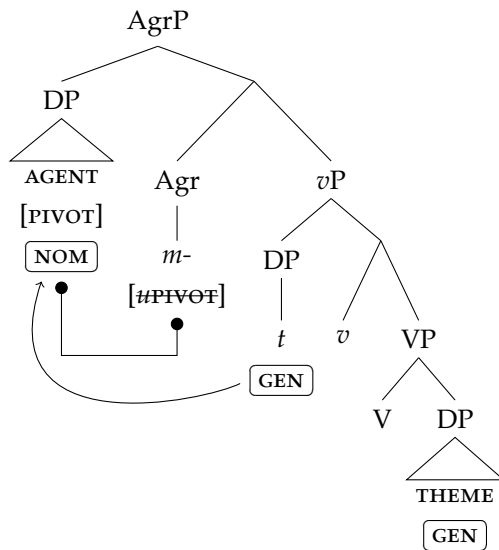

b. PV \rightarrow AGR^0 TARGETS THEME

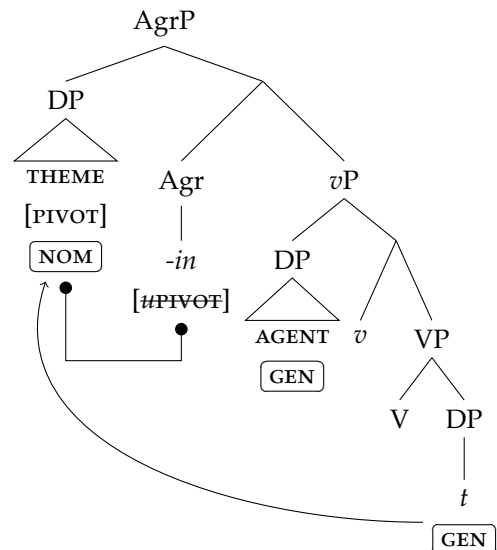

Following the discussion in Section 3.1.2, I assume that Agr^0 is also an abstract Case assigner. The result is that upon its Merge in the Spec-AgrP position, the relevant DP receives a *second* abstract Case value of nominative in addition to the value of genitive Case assigned in the relevant theta-position (agent or theme), as was shown in (28). Here, I follow the MCC analysis of Béjar and Massam (1999) as described above, and posit that Tagalog is a language that exhibits their proposed locality requirement on the interpretability of Case. The result is that in the derivations in (29), only the higher value of nominative

Case, which appears on an overt DP, is spelled out at PF, resulting in morphological nominative case (i.e., *ang*-marking). In contrast, the lower value of genitive remains on the trace of the moved DP, which is unpronounced.

The trees in (29) also show that Agr^0 is spelled out as one of the Tagalog voice morphemes: *m- / <um>*, *-in*, *-an*, or *i-*. In this thesis, I do not develop a full account of how this morphology is determined. We have seen in Section 3.1 that the issue as a whole is quite complex, being closely intertwined with various fine details of argument structure and its alternations. The full range of these distinctions ultimately does not play a central role in the main objective of this thesis, which is to address structural differences between A' -dependency constructions that target DPs and those that target non-DPs. In this regard, *how* voice morphology correlates with the identity of A' -dependency targets in some constructions but not in others is less important than the fact *that* such a correlation exists. As will be argued primarily in Chapters 4 and 7, the asymmetry between types of A' -dependencies is crucially sensitive to the DP-hood or otherwise of the dependency target, and not to argument structure. Furthermore, Chapter 6 shows that in the subset of these dependencies where argument structure *is* relevant, broader notions of external and internal argumenthood are sufficient to capture the generalizations. I thus defer to previous work over the years, that has investigated the issue of (Philippine-type) voice and argument structure alternations.

Within the generative literature in particular, Chen (2017) and Rackowski (2002) discuss in detail the dependent marking and voice morphology patterns associated with transitive and intransitive clauses, their causatives, as well as ditransitives. In Section 3.4.1, I ultimately argue against their characterizations of the nature of *ang*-marking itself. However, their general approach to the *assignment* of *ang*-marking and the resulting spell-out of voice morphology are similar in spirit to the proposal put forth in this chapter. For both Chen (2017) and Rackowski (2002), the voice morphemes are treated as the morphological reflex of a single syntactic head, which agrees with the pivot of the clause. This instance of Agree directly results in (i) *ang*-marking on the pivot, and (ii) spell-out of the probing head as one of the voice morphemes, based on properties of the pivot, effectively casting the voice morphemes as a type of morphological agreement. For Rackowski, the relevant property conditioning this spell-out is (abstract) Case, while Chen takes a slightly different approach, assuming that spell-out is sensitive to the “residue” of previous Agree relations that the goal has entered into, including but not limited to those involved in Case licensing. Comparing with the current proposal, we see that (i) describes what was shown in (29), and what is left underdetermined is (ii). Application of the previous accounts is not straightforward, specifically because they assume a system of abstract Case that is closer to typical nominative-accusative systems (e.g., external arguments receive nominative Case from T^0/I^0). However it is also not immediately obvious that accounts along the lines of morphological agreement are fundamentally incompatible with the present proposal. I thus leave investigation of the specifics of voice morphology for future work.

So far, I have posited that core argument DPs that appear as pivots are assigned two instances of abstract Case over the course of the derivation, but due to the locality requirements on the PF-interpretability of Case adopted from Béjar and Massam (1999), only the highest value assigned is reflected morphologically. While this proposal represents a complication to the mechanisms behind Case, it follows the precedent of much previous work on Tagalog and other Austronesian languages noting the unusual behavior of case marking and processes typically associated with it (i.e., A-movement).

With respect to case marking, we have already seen the patterns of invariant underlying Case that

provide (indirect) evidence for the lower Case value assigned to a pivot DP before it moves to SpecAgrP. These patterns were discussed in Section 2.4.3 and were noted as early as Ramos 1974. Turning to Austronesian languages more broadly, we have so far seen that Béjar and Massam (1999) originally proposed their MCC analysis to apply to Niuean (Polynesian), in addition to other (non-Austronesian) languages. Another example can be found in recent work by Chen (2018a,b) on Amis (East Formosan). Adopting the dependent case model of Marantz (1991/2000), she proposes that all arguments in Amis systematically receive multiple case assignments over the course of a derivation. Only the final such assignment surfaces overtly in most contexts, but she shows that all underlyingly assigned case values surface as case stacking on contrastive topics. In (30) for example, compare the case stacking on contrastive topics (boldface) with the single case marking on their non-contrastive-topic counterparts.

(30) CASE STACKING ON CONTRASTIVE TOPICS IN AMIS¹⁴ (Chen 2018b, exx.15–16; some detail omitted)

- a. Mi-tefing {**ko-no wawa/ko-ni Lekal**} to siri.
 IMPF.AV-touch NOM-GEN child NOM-GEN Lekal ACC goat
 ‘**{The child/Lekal}** is touching (a) goat(s).’ NOM-GEN stacking on agents
- b. Mi-tefing ci Lekal {**?to-to-ya siri /to-ci akong-an**} i loma.
 IMPF.AV-touch NOM Lekal ACC-ACC-that goat ACC-ACC grandfather-ACC P home
 ‘Lekal is touching **{that goat/Grandfather}** at home.’ ACC-ACC stacking on themes

Comparing these languages, we see that multiple case assignment occurs to different extents. In Niuean, it is found in a specific type of construction (i.e., raising). In Tagalog, it is more general, occurring on one argument of the unmarked clause type of the language (i.e., pivots of voice-marked clauses). Finally, in Amis, it is yet more general, occurring on all DP arguments in a clause.

Implications of the distinctive behavior of case in Tagalog and Austronesian are also evident in work on processes that resemble A-movement in these languages. For example, Guilfoyle et al. (1992) propose an account of the Austronesian-type voice and case marking alternations in a handful of Austronesian languages, within a typology of passivization. They note that their proposal is incompatible with Burzio’s (1986) generalization about the correlation between the presence of an external theta role and the availability of accusative case for objects, as they argue that passives in the languages lack this accusative case even though they assign external theta roles in the same manner as active sentences (i.e., passive agents are not demoted). In the area of raising, research has shown that (apparent) instances of such constructions in Tagalog do not exhibit the same set of signature properties as in English-like languages.¹⁵ In particular, Maclachlan (1996, §6.4.1) and Nakamura (2000) observe that Case is available in the base position of a DP that has undergone raising in Tagalog, in contrast to the traditional assumption about such positions in English (recall (26)). This has led scholars to propose alternative analyses that eschew A-movement. For example, Maclachlan (1996) and Nakamura (2000) propose A’-movement approaches, noting strong par-

¹⁴Similar to Tagalog, Amis case markers exhibit allomorphy between common and personal forms, the latter also appearing with kinship terms (Chen 2018b, ex.14). Also, note that the personal accusative case marker, which appears in (30b) is complex: *ci ...-an*.

¹⁵Although it should be noted that I do not share many of the relevant judgments for the raising examples reported to be grammatical by these authors. This discrepancy may be due to dialectal differences (perhaps conditioned on geography, age, or social class) with the consultants these authors worked with. Along these same lines, Maclachlan (1996, p.224, fn.2) reports: “Sentences involving raising ... were acceptable to one speaker I worked with, who had clear judgments concerning the construction. Unfortunately, these judgments could not be verified with other speakers for whom such raising was not acceptable.”

allels between this construction and *wh*-movement, while Law (2011) pursues a prolepsis analysis, where the apparently raised DP originates in the matrix clause and is instead co-referent to a potentially null pronoun in the embedded clause.

Within the context of these A-movement operations, pivot movement to Spec-AgrP can be understood to be conceptually parallel to subject movement to Spec-TP in other languages, as both are instances of obligatory movement to a derived position where Case is assigned. However as with the other operations just discussed, significant formal differences exist. Specifically, movement of a subject is classically understood to be driven by its need for Case licensing (Koopman and Sportiche 1991), whereas we have seen so far that pivots undergo movement even if they have already received Case in their base positions, as such movement is driven by a discourse-related [PIVOT] feature. As has been proposed in this section, this alternative “version” of subject movement derives behavior that is reminiscent of cross-linguistic voice alternations (i.e., (anti-)passive), but shows differences with respect to case marking. I discuss this point in more detail in Section 3.4.2.¹⁶

Overall then, the idea that case in Tagalog (and other Austronesian languages) behaves in a cross-linguistically atypical way is not a new one, and can be used to make sense of various processes in this language. This line of analysis will be pursued further later on in Chapter 5, where I argue that an extension to the MCC proposal can account for particular details about the structure of various A/-dependency constructions in this language to be described in detail in Chapter 4.

To summarize this section, I have proposed a system for Case assignment in Tagalog that treats *ang*-marking as the morphological spell-out of abstract Case. We have seen so far that abstract Case (both nominative and genitive) is assigned to DPs by various syntactic heads following (internal or external) Merge. We have also seen how adopting Béjar and Massam’s (1999) Multiple Case Checking analysis accounts for configurations where a single DP effectively receives multiple values of abstract Case over the course of a derivation: once in its base position, and once after moving to Spec-AgrP. The key component for achieving this result is a requirement that abstract Case values be local (complement or specifier) to their assigning head in order to be interpretable at PF. I also discussed how this complication of how Case assignment works for Tagalog does not come out of left field given previous literature. However, the fact remains that so far, I have simply assumed that *ang* spells out abstract nominative Case and showed that this assumption is compatible with an account of the Tagalog voice and nominal marking alternations. Furthermore, previous accounts (e.g., Rackowski 2002) exist that account for these alternations without positing that *ang* spells out Case, obviating the need for this complication. Thus, it is necessary for the analysis developed here to show that *ang*-marking *must* be the morphological spell-out of abstract Case. I do this in the next section, where I argue that *ang*-marking is clearly tied to nominal licensing, which is a distinctive function of abstract Case.

¹⁶An obvious area for further research which I do not pursue in this thesis is to apply MCC and movement to Spec-AgrP to Tagalog raising. For this approach, Case being available in the base position of the raised DP is no longer a problem, and nothing in the current analysis prevents a DP from receiving abstract nominative Case twice. However, work in this area would need to set straight whether or not purported instances of raising are indeed grammatical (see also fn.15), or if there are external factors that affect this grammaticality.

3.3 Peripheral arguments and applicatives

We have just seen derivations where nominative (*ang*) appears on arguments underlyingly marked genitive (*ng*), resulting in a single DP receiving two values of abstract Case over the course of a single derivation. Recall, however, that clausal dependents may also be underlyingly marked with other markers, prominently oblique (*sa*). Such arguments, in turn, show alternations with nominative marking as well. This section considers their behavior with respect to the Tagalog voice system.

I present arguments from Rackowski (2002) that the nominative-oblique alternations shown by peripheral arguments in Tagalog involve two distinct structures. When such peripheral arguments surface as the *ang*-marked pivot they are introduced into the derivation as applied objects (see also Nie 2019a,b). Otherwise, when these arguments surface with oblique, they are general PP arguments or adjuncts. This contrasts with the nominative-genitive alternations we have seen previously, which stem from a common structural base.

I depart from Rackowski's proposal in terms of the mechanism that selects the pivot. Rackowski argues that the pivot is selected through a system of object shift and Case agreement, whereas the analysis developed in the previous section adopts a more direct approach with the [PIVOT] feature. I discuss this difference in more detail in Section 3.4.1, and focus in this section on how Agr^0 and the Case licensing system proposed here interact with the adopted argument structures. We will see that the availability of the applicative structure apparently overgenerates with respect to a previously noted restriction in Tagalog where derived objects like applied objects cannot stay in-situ and must instead surface as the pivot (see Rackowski 2002, §2.3.1.1.1; Travis 2001). Crucially, I show that this overgeneration problem is straightforwardly resolved under the view that *ang* (i.e., pivot marking) has a nominal-licensing function. In other words, under the assumption that all DPs in a clause must receive abstract Case, the behavior of applicatives shows us that *ang*-marking must spell out abstract nominative Case.

3.3.1 Two underlying structures

Alternations between oblique and nominative are common in the Tagalog voice system. (31) provides an example of this alternation with a locative argument *bukid* 'field' of the verb *tanim* 'plant'. This argument is the nominative-marked pivot of the LV sentence (31a), but appears with oblique marking in environments where another argument is the pivot—as in the AV and CV clauses (31b,c)—or where no nominative marking is assigned—as in the gerund (31d).

(31) ALTERNATION OF NOMINATIVE AND OBLIQUE

- a. T<in>a~tanim-an ni Wendy ng palay ang bukid.
 IMPF~plant-LV GEN.P Wendy GEN rice.plant NOM field
 'Wendy plants rice in the field.' NOM Goal
- b. Nagta~tanim si Wendy ng palay sa bukid.
 AV.IMPF~plant NOM.P Wendy GEN rice.plant OBL field
 'Wendy plants rice in the field.' NOM Agent; OBL Goal

- c. I-t<in>a~tanim ni Wendy ang palay sa bukid.
 CV-IMPF~plant GEN.P Wendy NOM rice.plant OBL field
 ‘Wendy plants the rice in the field.’ NOM Theme; OBL Goal
- d. (ang) pagta~tanim ni Wendy ng palay sa bukid
 NOM pag.RED~plant GEN.P Wendy GEN rice.plant OBL field
 ‘Wendy’s planting of rice in the field’ No NOM; OBL Goal

As was just mentioned, Rackowski (2002) argues that the pivot goal of an LV sentence like (31a) originates as an applied object. Specifically, she adopts Pylkkänen’s (2002) low (recipient) applicative, which indicates a transfer of possession where the direct object comes into the possession of the indirect/applied object (Pylkkänen 2002, p.15). In contrast to this applicative structure, Rackowski proposes that the parallel goal argument in (31b-d) is better analyzed as a PP argument of the verb.¹⁷ She assumes the structures provided in (32) below.

(32) a. *vP* STRUCTURE FOR (31a)

(adapted from Rackowski 2002, p.86)

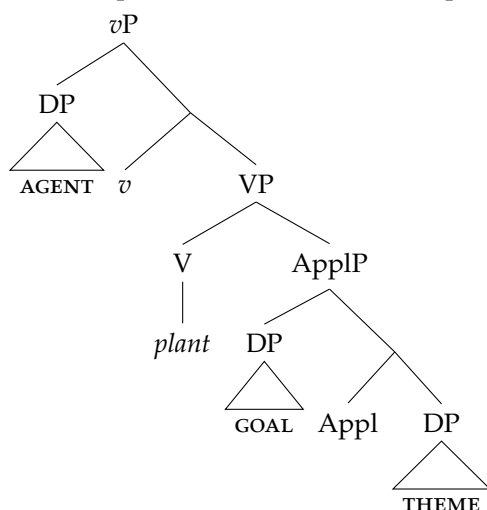

b. *vP* STRUCTURE FOR (31b-d)

(adapted from Rackowski 2002, p.87)

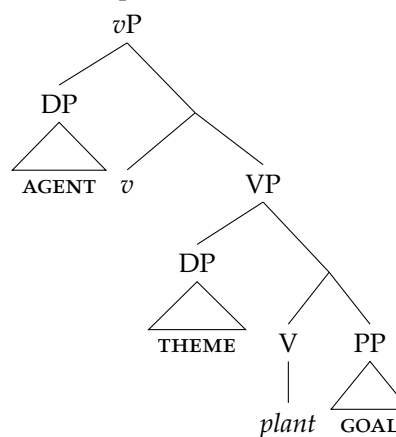

As evidence for this underlying structural difference, Rackowski (2002, §2.3.2) draws parallels to previous analyses of the dative shift in languages like English and Icelandic, and provides evidence from phenomena such as *wh*/focus and binding. Additionally, she discusses further semantic parallels found in languages that have robust applicative systems, such as Kinyarwanda, where applicative constructions are sensitive to differences between types of locatives. In Kinyarwanda, various types of locative phrases may appear in a clause as PPs, but crucially, only the so-called inner locatives, which are more argument-like, can be applicativized; the more adjunct-like outer locatives may only appear as PPs. The Kinyarwanda examples in (33-34) show this distinction.

¹⁷Note that for clauses with oblique-marked goals (notably ditransitives), Rackowski (2002, §2.3.2.2) proposes that their internal arguments are generated in a small-clause complement to V^0 . This is to account for reported symmetric binding between the (PP) goal and the theme, which I have found difficult to reproduce in my own consultant work. In particular, there is a confound in testing relative binding between a PP goal and a non-pivot theme (i.e., when the agent is the pivot), as non-pivot themes are highly marked if not ungrammatical with quantifiers like *bawat* ‘every’ as well as with possessors. Therefore, I will adopt the more *a priori* straightforward assumption that PP goals can be generated straightforwardly as arguments (as with *tanim* ‘plant’, *lagay* ‘put’, illustrated in (32b)) or adjuncts.

- (33) KINYARWANDA INNER LOCATIVES MAY APPLICATIVIZE (Rackowski 2002 citing Kimenyi 1980)
- a. Abaana b-iica-ye *ku meeza*.
children SP-sit-ASP on table
'The children are sitting on the table.' PP Inner Locative
- b. Abaana b-iica-ye-**ho** *meeza*.
children SP-sit-ASP-on table
'The children are sitting on the table.' Applied Inner Locative
- (34) KINYARWANDA OUTER LOCATIVES MAY NOT APPLICATIVIZE (Rackowski 2002 citing Kimenyi 1980)
- a. Abaana b-iica-ye *ku musozi*.
children SP-sit-ASP on mountain
'The children are sitting on (top of) the mountain.' PP Outer Locative
- b. *Abaana b-iica-ye-**ho** *musozi*.
children SP-sit-ASP-on mountain
Intended: 'The children are sitting on the mountain.' *Applied Outer Locative

Our original Tagalog examples in (31) with the goal *bukid* 'field' are parallel to the inner locative examples in Kinyarwanda. We have seen that this goal may appear as a PP (marked *sa*) or as an applied object (marked *ang*, with the verb in LV). We can also find examples that are parallel to the Kinyarwanda outer locative example. The examples in (35) differ minimally from those in (31) with respect to the goal. Here, we see that when the goal is a place name like *Bukidnon* or a different common noun like *kabilâng bayan* 'neighboring town', it is ungrammatical as a DP goal in LV (35a), but is well-formed as a PP goal elsewhere.

- (35) TAGALOG OUTER LOCATIVES MAY NOT APPLICATIVIZE
(cf. (31); patterned after Rackowski 2002, pp.54–55)
- a. *T<in>a~tanim-an ni Wendy ng palay **ang** {**Bukidnon**/**kabilâ=ng bayan**}.
IMPF~plant-LV GEN.P Wendy GEN rice.plant NOM *Bukidnon* other.side=LK town
Intended: 'Wendy plants rice in {Bukidnon/the neighboring town}.' *Applicative Locative
- b. Nagta~tanim si Wendy ng palay **sa** {**Bukidnon**/**kabilâ=ng bayan**}.
AV.IMPF~plant NOM.P Wendy GEN rice.plant OBL *Bukidnon* other.side=LK town
'Wendy plants rice in {Bukidnon/the neighboring town}.' PP Locative
- c. I-t<in>a~tanim ni Wendy **ang** palay **sa** {**Bukidnon**/**kabilâ=ng bayan**}.
CV-IMPF~plant GEN.P Wendy NOM rice.plant OBL *Bukidnon* other.side=LK town
'Wendy plants the rice in {Bukidnon/the neighboring town}.' PP Locative
- d. (ang) pagta~tanim ni Wendy ng palay **sa** {**Bukidnon**/**kabilâ=ng bayan**}
NOM GER~plant GEN.P Wendy GEN rice.plant OBL *Bukidnon* other.side=LK town
'Wendy's planting of rice in {Bukidnon/the neighboring town}.' PP Locative

The specific way in which (35a) is ungrammatical is also informative. At least one of my consultants notes that this sentence is possible, but only with the implausible meaning that Wendy covered the whole of the neighboring town or Bukidnon (a province in the Philippines) in rice plants. Such an interpretation is consistent with the proposed semantic contribution of Pylkkänen’s low recipient applicative, and similar semantic effects are reported by Rackowski (2002, p.55) for the Tagalog parallel of the Kinyarwanda sentence (34b), which uses LV, as (36) shows. She notes, “The only possible interpretations for this sentence are either that there is a tiny toy mountain or that the children are giants who use mountains as chairs.” Such an implication does not occur with (35b-d), by comparison, suggesting that these examples do *not* feature the relevant applicative.

- (36) <In>u~upu-an ng mga bata **ang** {lamesa/*bundok}.
 IMPF~sit-LV GEN PL child NOM table mountain

‘The children are sitting on the {table/mountain}’

(Rackowski 2002, pp.54–5)

Positing two distinct structures thus allows us to straightforwardly capture contrasts like the one exemplified by (31) and (35). On one hand, certain kinds of adjuncts are fairly flexible in their syntax and semantics, as they are unselected and are therefore more flexible in where they merge into the structure. On the other hand, applied objects are introduced by syntactic heads, which may be associated with more specific semantic content.

How does Agr⁰ behave or interact with this alternation between the applicative structure (32a) and the PP structure (32b)? The AV and CV examples (31b-c) and (35b-c) are derived straightforwardly with the initial proposal given in the previous section. The derivation is shown diagrammatically in tree (37). If Agr⁰ is present, as in this tree, it may target either the agent or the theme, depending on which argument bears the [PIVOT] feature. Note that the contrast between inner and outer locatives also leads us to conclude that Agr⁰ cannot target or probe into PPs, otherwise we would incorrectly predict that (35a), with *Bukidnon* or *kabilâng bayan* ‘neighboring town’ as the pivot, should be derivable from the same underlying structure as (35b-d). In other words, even if the [PIVOT] feature appeared on the goal, it would be inaccessible to the probe on Agr⁰. This impossibility is indicated by the dashed arrow in (37), with the outer locative goal (e.g., *Bukidnon*, *kabilâng bayan*) subsequently surfacing as a PP.

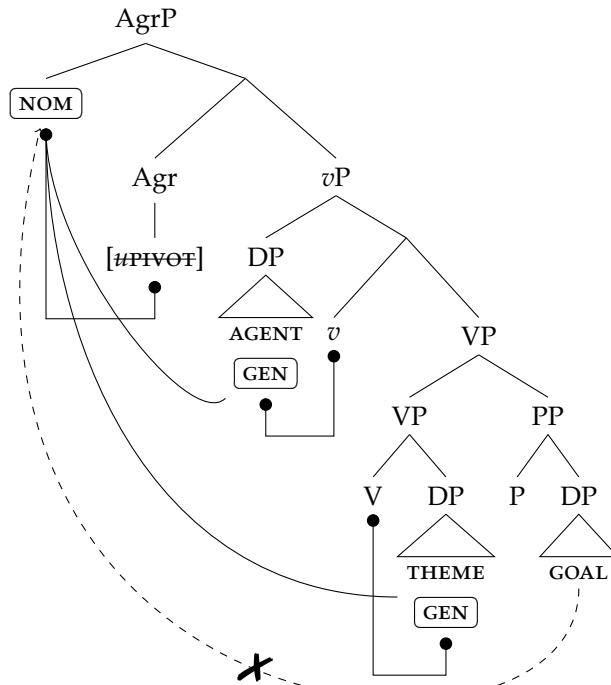
(37) TARGETS FOR AGR^0 IN A PP STRUCTURE

If Agr^0 is absent, such as in a gerund, then there is no pivot, but the derivation still converges, as all DPs are licensed with genitive Case in their base positions, and the PP goal does not require Case. Thus, the core arguments surface with underlying genitive marking, and the peripheral argument surfaces with oblique marking. In a PP structure, then, the goal PP is in some sense inert with respect to the syntactic derivation.

With the applicative structure on the other hand, LV clauses with goal pivots are straightforwardly derived if the applied object DP goal bears the [PIVOT] feature. This derivation is shown in (38). As we see, the goal is assigned nominative Case in Spec-AgrP, while the core arguments remain in their base positions with their underlying genitive Case assignments. Note also that here, I assume that Appl^0 assigns Case. Following the previous discussion in Section 3.2 (cf. 28), Appl^0 also assigns inherent genitive Case to the theme. Finally, there is an important question that this derivation leaves unanswered. Does the applied object introduced in Spec-AppIP receive abstract Case in its base position? In the next section, I argue that the answer to this question is “no”. For now, let us summarize what we have seen so far.

(38) DERIVATION OF AN LV CLAUSE WITH GOAL PIVOT (e.g., (31a))

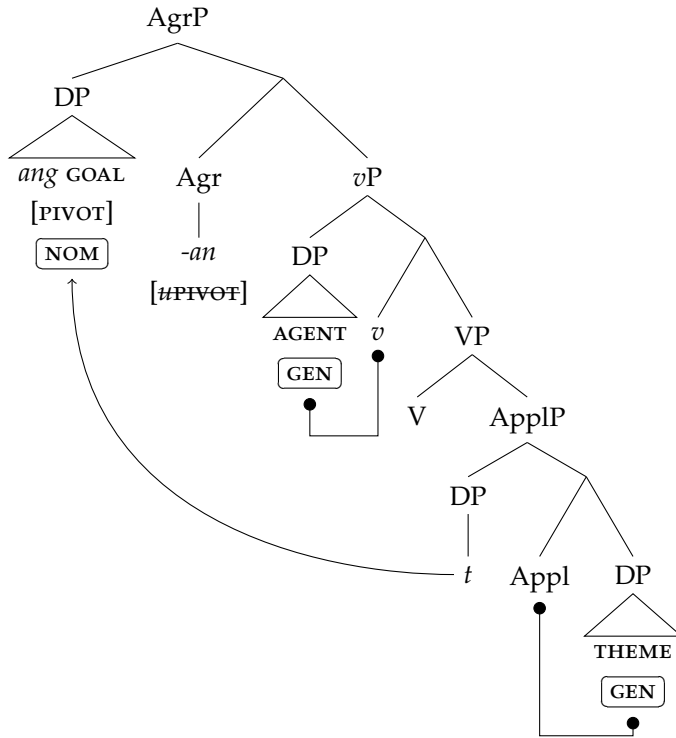

The different derivational possibilities discussed so far and their results are summarized in Table 3.2. For the PP structure, we have discussed derivations where the [PIVOT] feature appears on a core argument, where it appears on a (PP-internal) peripheral argument, and where Agr⁰ is absent. For the applicative structure, we have so far only seen the case where [PIVOT] appears on the peripheral argument, which is a DP in this case. The cells corresponding to the remaining possibilities, where a core argument bears [PIVOT], and where no Agr⁰ is present, are grayed out. I turn to these remaining possibilities now.

Table 3.2: Derivational possibilities with PP- and applicative structures (incomplete)

	PP STRUCTURE	APPLICATIVE
[PIVOT] on core arg.	AV/PV/CV clause ↔ Core arg. pivot ↔ PP peripheral arg.	
[PIVOT] on peripheral arg.	✗ (Peripheral arg. is inaccessible to Agr ⁰)	LV clause ↔ Genitive core args. ↔ Peripheral arg. pivot
Agr ⁰ absent	Gerund, RPFV clause ↔ No pivot ↔ PP peripheral arg.	

3.3.2 Applicative structure is deficient

We have just seen that an LV clause is successfully derived from an applicative structure when the applied object bears a [PIVOT] feature, ultimately causing the applied object to move to Spec-AgrP. Recall, however, that I assume that the distribution of [PIVOT] is determined by information-structural considerations, and is therefore effectively free for current purposes. Because of this, two alternative derivations are conceptually possible given the adopted applicative structure. In these alternatives, [PIVOT] appears not on the goal, but on either the agent or the theme instead. This in turn predicts that we should find apparent double object constructions where the pivot is a core argument, the verb is not marked LV, and the goal appears as a (*ng*-marked) DP instead of a (*sa*-marked) PP. Contrary to this prediction, such constructions are ungrammatical in Tagalog, as shown in (39), and we therefore have an overgeneration problem.

(39) NO NON-LV DOUBLE OBJECT CONSTRUCTIONS¹⁸ (cf. 31)

a. *Nagta~tanim si Wendy ng bukid ng palay.
 AV.IMPF~plant NOM.P Wendy GEN field GEN rice.plant

Intended: 'Wendy plants rice in the field.'

b. *I-t<in>a~tanim ni Wendy ng bukid ang palay.
 CV-IMPF~plant GEN.P Wendy GEN field NOM rice.plant

Intended: 'Wendy plants the rice in the field.'

The generalization, which has been pointed out for Tagalog (by Rackowski 2002) and a number of other Austronesian languages (see, e.g., Travis 2001), is that non-pivot derived objects are ill-formed. We might take this observation as evidence against the existence of applicative structures in Tagalog, since assuming such structures apparently creates the aforementioned overgeneration problem. However, I argue that the ungrammaticality of examples like those in (39) is instead readily accounted for as a natural interaction between the applicative argument structure and the Case licensing system proposed here. Specifically, I claim that the ill-formedness of the above examples stems from a lack of Case licensing for the applied object in its base position of Spec-AppIP. The corollary of this claim is that when an applied object *is* licit it must have been Case licensed. Since applied objects are only licit as *ang*-marked pivots, we conclude that *ang* must be what carries out this Case licensing function.

From the convergent derivation of the LV clause in (38), we saw that the agent and the theme were assigned Case in-situ, as a result of Merge with their respective Case assigners, v^0 and AppI^0 . The claim, then, is that this in-situ Case assignment does not occur with applied objects, specifically that AppI^0 only has one instance of Case to assign, which goes to the theme in its complement. Note further that the applied object cannot receive Case from the c-commanding V^0 . This possibility can be straightforwardly ruled out by the core assumption of the MCC analysis, which is that Case values must be in either the specifier or the complement of their assigning head. Here, in-situ Case assignment to the applied object

¹⁸In these examples, I have switched the order of the goal *bukid* 'field' and the theme *palay* 'rice plant' in order to avoid instances of the string *palay ng bukid*, where *bukid* may be interpreted as a modifier of *palay*. Under such an interpretation, the clauses would be (mono-)transitive, and should be acceptable (or at least more so than the double object version). Nevertheless, one of my consultants appeared to attempt to repair (39a) in particular by interpreting *palay* as a modifier of *bukid* (i.e., 'Wendy {plants/is planting} a field of rice'), but commented that she was not sure whether *tanim* could be used with *bukid* as the thing being planted, and ultimately judged the example as strange.

is ruled out because it is in Spec-AppIP, so assigning abstract genitive Case from V^0 would result in that Case value being too distant from its assigning head. As for *moving* to Spec-VP for Case, I assume that this is also ruled out for the reason that there is no independent trigger for such movement. Contrast this with movement to Spec-AgrP, which is driven by the [PIVOT] feature, and not by Case assignment in and of itself.¹⁹

(40) NON-CONVERGENT APPLICATIVE STRUCTURE WITH AGENT IN SPEC-AGRP

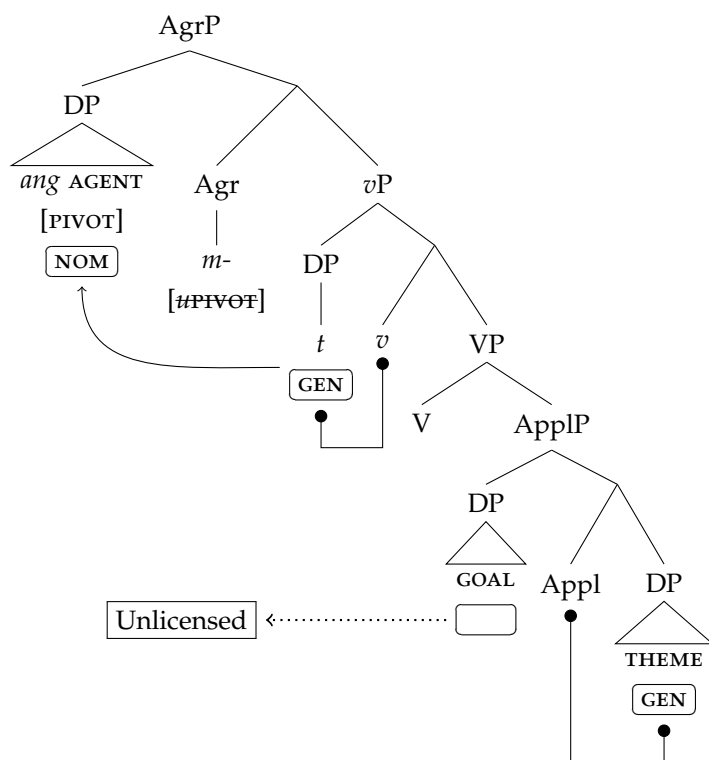

The result, then, is that the applied object cannot be licensed within vP and must receive Case from some other source, which is Agr^0 . In other words, nothing *a priori* prevents [PIVOT] from appearing on a DP other than the goal in the applicative structure, as exemplified in (40) with this feature on the agent. However, this derivation ultimately crashes because another DP has received nominative Case, leaving the goal DP without Case, so we correctly rule out the non-LV double object constructions shown in (39).

This view that the applied object is not Case licensed in-situ and instead relies on a non-local source of Case finds precedent in the literature on raising applicatives (Baker and Collins 2006; Georgala et al. 2008; Georgala 2012).²⁰ Work in this area proposes to separate the argument-introducing (or thematic) functions and the argument-licensing functions of applicative structure, assigning them to different syntactic projections. In this regard, $Appl^0$ in Tagalog only has the argument-introducing function, at least with regards to the applied object. Where the current proposal differs is in the eventual Case licensing for

¹⁹This argument ruling out movement is admittedly a little stipulative, and one could in principle formulate reasons for moving to Spec-VP. One such candidate might be (something parallel to) object shift. However, at least for object shift, we have independent evidence showing that this kind of movement is irrelevant for licensing the applied object. Section 3.4.1 shows that certain constructions allow to have a definite interpretation (i.e., allow object shift), but nevertheless do not license (non-pivot) applicatives.

²⁰See also Nie 2019a,b for an account of possessor raising in Tagalog along similar lines, but with different assumptions about the source of nominative Case.

the applied object. Previous literature has proposed an athematic high applicative projection (i.e., between VP and *vP*/VoiceP) that raises the applied object, allowing it to be assigned Case by a higher syntactic head. On the other hand, the proposal advanced here assumes that the applied object must move *outside* of *vP*, and receives Case from the syntactic head triggering this movement. Exploring this potential point of cross-linguistic variation could be a potentially fruitful avenue of research, particularly due to the observation previously noted (Travis 2001; see also discussion in Nie 2019a) that many Austronesian languages appear to lack a derived object position. For present purposes, I set this issue aside for future work.

Further support for this approach also comes from a prediction that is borne out regarding ungrammatical double object configurations in other environments. So far in (40), we have considered an environment where (nominative) Case for the applied object is unavailable because it has been assigned to a different DP. However, we also expect the same Case licensing problem to occur if the source of this Case is simply not present in the structure. As we have seen, gerunds are one such environment, and as (41a) shows double object gerunds are indeed ungrammatical. We see that the goal argument cannot surface as a DP, which is what we would expect with the applicative structure. In contrast, (41b) shows that the goal is well-formed as a PP, as we have seen previously. We can now fill in the missing cells of our summary table to arrive at Table 3.3.

(41) NO DOUBLE OBJECT GERUND

- a. *(ang) pagta~tanim ni Wendy **ng bukid** ng palay
 NOM GER~plant GEN.P Wendy GEN field GEN rice.plant
 Intended: ‘Wendy’s planting of rice in the field’ Applicative/double object structure
- b. (ang) pagta~tanim ni Wendy **sa bukid** ng palay
 NOM GER~plant GEN.P Wendy OBL field GEN rice.plant
 ‘Wendy’s planting of rice in the field’ PP structure

Table 3.3: Derivational possibilities with PP- and applicative structures

	PP STRUCTURE	APPLICATIVE
[PIVOT] on core arg.	AV/PV/CV clause \hookrightarrow Core arg. pivot \hookrightarrow PP peripheral arg.	X (Peripheral argument is unlicensed)
[PIVOT] on peripheral arg.	X (Peripheral arg. is inaccessible to Agr ⁰)	LV clause \hookrightarrow Genitive core args. \hookrightarrow Peripheral arg. pivot
Agr ⁰ absent	Gerund, RPFV clause \hookrightarrow No pivot \hookrightarrow PP peripheral arg.	X (Peripheral argument is unlicensed)

3.3.3 Other types of applicatives

So far in this section, the discussion has focused on a particular type of peripheral argument, the (ditransitive) goal, and its behavior with respect to the voice system. We have seen arguments from Rackowski (2002) that the alternation between pivot goals and PP goals stems from a difference in base structure, and that this different base structure can be diagnosed by looking at the behavior of slightly different types of goals. As she further points out, this general pattern we observe with ditransitive goals is not limited to these constructions. For example, we can clearly see similar behavior with instrumentals.

Instruments appear as the pivot in a sentence when the verb is in the so-called instrumental voice form (Schachter and Otnes 1972, §5.11), which is characterized by CV *i-* and the prefix *paN-*. When not the pivot, they can occur as adverbial phrases usually of the form *gámit ang X* ‘using (the) X’ or *sa pamamagitan ng X* ‘by means of X’.

(42) TAGALOG INSTRUMENTALS

- a. I-p<in>am-punas ng bata ng sahig ang luma=ng t-shirt.
CV-<PFV>*paN*-wipe GEN child GEN floor NOM old=LK t-shirt
‘The child wiped the floor with the old t-shirt.’
- b. Nag-punas ang bata ng sahig gámit ang luma=ng t-shirt.
AV.PFV-wipe NOM child GEN floor use NOM old=LK t-shirt
‘The child wiped the floor using the old t-shirt.’
- c. P<in>unas-an ng bata ang sahig gámit ang luma=ng t-shirt.
<PFV>wipe-LV GEN child NOM floor use NOM old=LK t-shirt
‘The child wiped the floor using the old t-shirt.’

Parallel to the distinction that we saw with goal arguments where only a subset of locatives were licit as pivots (i.e., inner vs outer locatives), not all types of instruments are possible as pivots. Rackowski (2002) notes that the instrumental voice in Tagalog appears to distinguish between so-called *intermediary agent* and *facilitating* instrumentals. The difference between the two can be illustrated in English, where intermediary agent instruments can appear in subject position while facilitating instruments cannot, as in (43-44). We can see this distinction in Tagalog by comparing (42a-b) to (45).

(43) INTERMEDIARY AGENT INSTRUMENTALS CAN BE SUBJECTS (Rackowski 2002 quoting Marantz 1984)

- a. Elmer unlocked the porcupine cage *with a key*.
b. *A key* unlocked the porcupine cage.

(44) FACILITATING INSTRUMENTALS CANNOT BE SUBJECTS (Rackowski 2002 quoting Marantz 1984)

- a. Elmer examined the inscription *with the magnifying glass*.
b. **The magnifying glass* examined the inscription.

(45) FACILITATING INSTRUMENTALS CANNOT BE PIVOTS (patterned after Rackowski 2002, p.34)

a. K<um>anta si Alex gámit ang pula=ng mikropono.

<AV>sing(PFV) NOM.P Alex use NOM red=LK microphone

‘Alex sang using the red microphone.’

b. *I-p<in>ang-kanta ni Alex ang pula=ng mikropono.

CV-<PFV>INS-sing GEN.P Alex NOM red=LK microphone

Intended: ‘Alex sang using the red microphone.’

cf. ‘*The red microphone sang.’

As with goals, we can understand the sensitivity to the type of instrument as a difference in how the instrument is introduced into the structure. With an adverbial phrase like *gámit ang X*, we have a more clearly adjunct-like structure, while the restricted nature of the instrumental voice form suggests that the instrumental argument has been selected for. Thus, I follow Rackowski (2002) and Nie (2019a,b) in assuming that instrumental arguments are introduced in the specifier of a high ApplP headed by *paN-*.

Also parallel to what we have seen with goals, we have evidence that *paN-* does not Case license its specifier; applied instruments must receive Case from somewhere else. First, instrumental *paN-* appears with no other voice morphology except CV *i-*; we do not find instrumental *paN-* with AV, PV, or LV, as exemplified in (46). In these cases, nominative has been valued on another argument in the clause, leaving the instrument without Case.²¹

(46) INSTRUMENTAL NOT COMPATIBLE WITH OTHER VOICE MORPHEMES

a. *{Nam-punas/Nag-pam-punas} ang bata ng sahig ng luma=ng t-shirt.

AV.INS-wipe AV.PFV-INS-wipe NOM child GEN floor GEN old=LK t-shirt

Intended: ‘The child wiped the floor using the old t-shirt.’

*AV + *paN-* (cf. 42b)

b. *P<in>am-punas-an ng bata ang sahig ng luma=ng t-shirt.

<PFV>INS-wipe-LV GEN child NOM floor GEN old=LK t-shirt

Intended: ‘The child wiped the floor using the old t-shirt.’

*LV + *paN-* (cf. 42c)

Second, we do not find gerunds with instrumental *paN-* and an applied instrument, as in (47a). In this construction, there is simply no source of NOM, so the applied instrument cannot be licensed. Nominal constructions with *paN-* are possible, but these must denote instrument entities, and not events, as shown in (47b). Finally, as expected, gerunds with adverbial instrument phrases are also possible, as these do not need to be Case licensed.

²¹Rackowski (2002, pp.49–53) mentions the existence and provides examples of what she calls bare instruments, proposing that they are introduced in the specifier of a low applicative. An example is given in (i). While the existence of a non-pivot DP instrumental contradicts the claims I have made so far (although note the absence of *paN-*), the speakers I have consulted (and my own intuitions) reject such sentences, a detail which I have indicated in the example.

(i) [*]Da~dalh-in ko ng sipit ang isda sa mesa.

FUT~bring-PV 1SG.GEN GEN [tongs] NOM fish OBL table

‘I’ll take the fish to the table with [tongs].’ Rackowski 2002, p.49 citing Kroeger 1993; square brackets mine, incl. judgment

- (47) a. *ang {pam-pagpu~punas/pam-(pu~)punas} ng bata ng sahig ng luma=ng t-shirt
 NOM INS-GER-wipe INS.GER-wipe GEN child GEN floor GEN old=LK t-shirt
 Intended: ‘the child’s wiping of the floor using the old t-shirt’ *Gerund with DP instrument
- b. ang pam-(p)unas ng bata ng sahig
 NOM INS-wipe GEN child GEN floor
 ‘the child’s instrument for wiping the floor’ Instrument nominalization
- c. ang pag-punas ng bata ng sahig gámit ang luma=ng t-shirt
 NOM GER-wipe GEN child GEN floor use NOM old=LK t-shirt
 ‘the child’s wiping of the floor using the old t-shirt’ Gerund with adv. phrase instrument

In this section, I have demonstrated how the Case licensing system proposed in this chapter derives the behavior of peripheral arguments in Tagalog. I showed that this Case licensing system, including the mechanism for assigning nominative Case, interacts well with the alternation between the PP- and applicative argument structures proposed by Rackowski (2002). In particular, it accounts for the limited distribution of clauses with DP peripheral arguments as a problem tied to Case licensing. As discussed, this limited distribution is otherwise mysterious assuming the general availability of the applicative structure.

3.4 Against previous accounts

In this section, I discuss and reject previous analyses that have been proposed for the nature of *ang*-marking, as well as the Case licensing system of Tagalog in general. I first discuss the alternative view that *ang* does not mark Case, and is instead the reflex of some other syntactic process such as information-structural topicalization. We will see that taking this analytical route poses problems for explaining the restricted distribution of applied objects. Then, I discuss two broad types of approaches that do treat *ang* as Case, but argue for different kinds of Case licensing mechanisms than the one proposed in this chapter. Here, we will see that these approaches either run into the same problem as the first alternative view considered, or must propose redundant mechanisms to account for the nominal marking patterns across a broader range of environments.

3.4.1 Against *ang* as “other”

While I have shown that treating *ang*-marking as Case is advantageous, it comes at the cost of adopting mechanisms to account for the arguably non-Case-like behavior of marking DPs that have already received (genitive) Case. The alternative, then, is to treat *ang*-marking as something other than Case. This type of approach has been taken in previous research on Tagalog. For example Chen (2017) treats *ang* as marking topichood, adopting a common discourse/information structure marker approach. On the other hand, Rackowski (2002) (see also Rackowski and Richards 2005) treats this marker as a reflex of an Agree relation between a DP with an existing Case value and the functional head hosting voice morphology.

These analyses formally separate the processes of Case assignment/licensing and *ang*-marking. Once all arguments are independently assigned Case, *ang*-marking occurs and morphologically obscures the underlying Case value assigned to the pivot. This process produces the distinctive covariation in the assignment of *ang* and voice morphology on the verb while accounting for the underlying patterns of nominal marking discussed in Section 2.4.3.

There is significant overlap between these *ang*-as-other approaches and the proposal developed in this chapter. On some level of abstraction, identical claims are made for the behavior of agents and themes: these arguments are assigned some underlying value of Case that is then overwritten by *ang*-marking (whatever the formal treatment of this marking is). Where we find the crucial difference is with the peripheral arguments, or more specifically applied objects. For the *ang*-as-other approaches, applied objects behave in the same way as core arguments: they are assigned a value of Case that is then overwritten by *ang*-marking, which is formally not analyzed as Case. For the Case-based analysis developed here, however, applied objects have no source of Case licensing *other than ang*-marking.

This difference with respect to the treatment of applied objects has consequences for the empirically restricted distribution of these arguments discussed in Section 3.3.2. Specifically, the availability of Case licensing distinct from *ang*-marking under the *ang*-as-other approaches creates precisely the overgeneration problem that the Case-based analysis avoids. Thus, while the *ang*-as-other approaches are more parsimonious in the sense that they do not need to propose complications to Case licensing, this comes at the cost of complicating other areas of syntax in ways that are arguably more stipulative.

For the purposes of discussion, I take Rackowski's (2002) object shift analysis of Tagalog as representative. Under this analysis, the voice alternations in Tagalog are ultimately tied to a system of object shift, which allows for the definite interpretation of internal arguments, similar to what we find in many Germanic languages, like Icelandic. This object shift happens at the level of *v*P, and feeds a proposed process of Case-agreement tied to I^0 , which itself leads to the spell-out of voice morphology.

To illustrate, let us first set aside the issue of peripheral arguments and consider how the object shift analysis derives the difference between AV and PV for the monotransitive sentences given in (48). Following Chomsky's (2001) analysis of object shift, Rackowski (2002, chap.3) formalizes the occurrence of object shift as the specification of [+EPP] on v^0 .²² Thus, in a monotransitive sentence, two derivations are possible, depending on whether or not v^0 bears a [+EPP] feature. If it does, as shown in (49a), it attracts the highest c-commanded DP, the theme, to its outer specifier. Having escaped VP, the theme can then be interpreted as definite, following Diesing (1992). On the other hand, (49b) shows a derivation where v^0 lacks [+EPP]. Here, the theme stays in its base position and must be interpreted as indefinite.

Other than affecting the definiteness of the theme, object shift is also proposed to feed a process of Case-agreement, where a [*u*CASE] feature on I^0 probes its c-command domain for the closest DP, which will have already been assigned Case. The reflexes of this Agree relation are (i) *ang*-marking on the DP goal of Agree and (ii) realization of Case on I^0 as one of the voice morphemes. Rackowski (2002, p.110) adopts a nominative-accusative alignment for Tagalog, so the transitive theme is assigned structural accusative by v^0 , while the transitive agent is assigned structural nominative by I^0 . Consequently, PV *-in* reflects Agree with a DP assigned ACC, while AV *m-* reflects Agree with a DP assigned NOM. Note that these Case values

²²Note that Rackowski (2002) assumes a split between *v*P and VoiceP projections. I abstract away from this here to simplify the discussion.

are otherwise not reflected on the DPs themselves, as the same marking *ng* appears on non-pivot agents with nominative Case (cf. 49a) and on non-pivot themes with accusative Case (cf. 49b).

- (48) a. Ba~basah-in ng manager ang ulat.
 FUT~read-PV GEN manager NOM report

'The manager will read the report.'

PV → theme gets *ang*, is definite

- b. Mag-ba~basa ang manager ng ulat.
 AV-FUT~read NOM manager GEN report

'The manager will read a report.'

AV → agent gets *ang*, theme is indefinite

(49) DERIVATIONAL POSSIBILITIES FOR MONOTRANSITIVE

(following Rackowski 2002)

- a. Object Shift ([+EPP]) → PV *-in*, Theme *ang* = (48a)

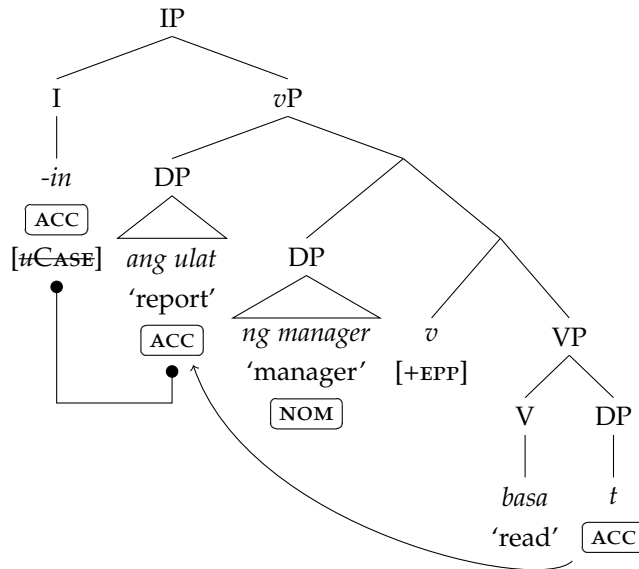

- b. No Object Shift → AV *m-*, Agent *ang* = (48b)

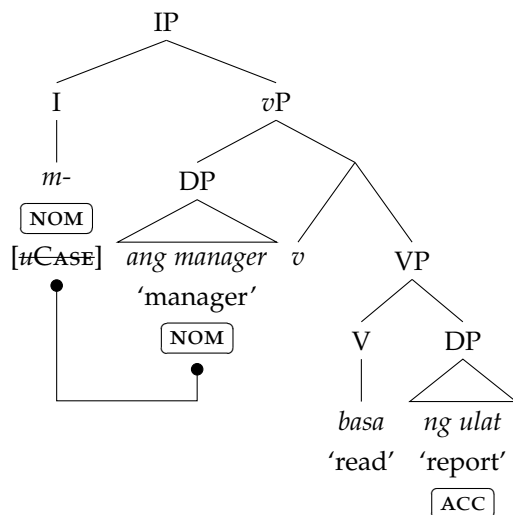

Let us now consider how the derivation proceeds when a peripheral argument, such as a ditransitive goal, is the pivot, as in (50). As previously discussed in Section 3.3, Rackowski (2002) assumes that pivot goals are introduced into the derivation as DP specifiers of a low ApplP. Under this analysis, such DPs are assumed to be assigned structural dative Case. Furthermore, in this applicative structure, the goal is the highest internal argument, so if v^0 bears a [+EPP] feature (i.e., if object shift occurs), it is the goal that is attracted to the outer Spec- v P. Consequently, this argument becomes the closest DP to the Case-agreement probe on I^0 , so it gets surface *ang*-marking, and LV *-an* is spelled out on the verb as the exponent of Agree with a DAT DP. This derivation is shown in (51).

- (50) Bi~bigy-an ng manager ang empleyado ng gantimpala.
 FUT~give-LV GEN manager NOM employee GEN reward
 ‘The manager will give the employee an reward.’

LV → goal gets *ang*

- (51) DERIVATIONAL OF GOAL PIVOT CLAUSE

(following Rackowski 2002)

Object Shift ([+EPP]) → LV *-an*, Ditransitive Goal *ang* = (50)

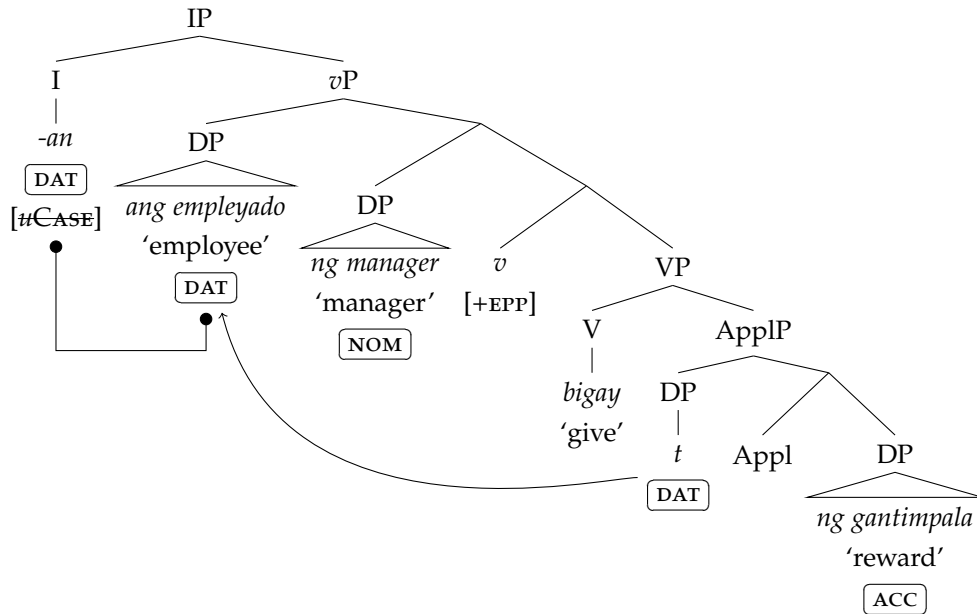

The example just shown is the derivation that results from an applicative structure *if object shift applies*. What about if it doesn't (i.e., v^0 is not specified [+EPP])? In this scenario, the agent in Spec- v P is the closest DP to the Case-agreement probe, so we predict the generation of an AV clause with two DP internal arguments. This result amounts to an AV double object construction, which is not attested, as we have seen in the earlier discussion in Section 3.3. The derivation is shown in (52), with the resulting ungrammatical sentence given in (53).

(52) UNATTESTED DERIVATION

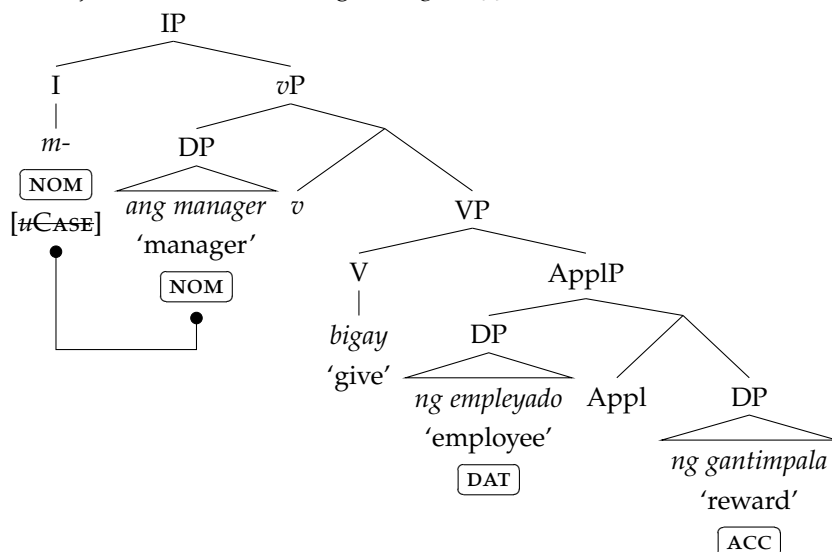
No Object Shift → AV *m-*, Agent *ang* = (53a)(53) NO NON-LV DOUBLE OBJECT CONSTRUCTIONS²³

parallel to (39)

a. *Magbi~bigay ang manager ng empleyado ng gantimpala .

AV.FUT~give NOM manager GEN employee GEN reward

Intended: 'The manager will give a reward to an employee.'

b. *(ang) pagbi~bigay ng manager ng empleyado ng gantimpala

NOM GER~give GEN manager GEN employee GEN reward

Intended: 'the manager's giving of a reward to the employee'

Grammatical as: 'the employee's manager's giving of a reward'

As mentioned earlier in this section, we cannot resort to Case as a mechanism for preventing the generation of examples like (53) under typical analyses that do not treat *ang* as a Case marker because these analyses assume that DPs in the clause receive Case independently from *ang* assignment. Particularly for the object shift analysis of Rackowski (2002), it is crucial that the applied goal argument receive dative Case, as this Case is tied to the realization of LV *-an* on the verb when the goal is the pivot (i.e., when it is the target of Case-agreement).

How, then, might we exclude non-LV double object constructions under the object shift analysis? The question amounts to how one would force object shift to always occur with double object constructions. Perhaps the most straightforward possibility is to assume that applicative structures are only generable when the (in this case) goal argument is definite. The applied argument would then have to undergo object shift in order to have the correct interpretation, in turn making it the closest goal for the Case-agreement probe. I argue that such a constraint on the availability of base-generated structures is stipulative, but more importantly, it also fails to account for the unavailability of the applicative structure

²³The object shift analysis correctly excludes the scenario where the theme in an applicative structure becomes the pivot. The theme cannot undergo object shift (without the goal also doing so), as another DP intervenes between it and the object shift probe.

in gerunds, previously discussed in Section 3.3, and shown again in (53b). This problem arises because the definiteness restriction on internal arguments (particularly themes) that are not pivots is relaxed in a number of environments, such as in gerunds. Compare the AV clause and corresponding gerund in (54).

(54) DEFINITENESS RESTRICTION IS RELAXED IN GERUNDS

- a. Nag-basa ang guro {ng /*sa } thesis.
 AV.PFV-read NOM teacher GEN OBL thesis
 ‘The teacher read {a/*the} thesis.’
- b. Ma-bilis ang [pag-basa ng guro {ng /sa } thesis].
 ADJ-fast NOM pag-read NOM teacher GEN OBL thesis
 ‘The teacher’s reading of {a/the} thesis was fast.’

Given that internal arguments can freely be interpreted as definite in gerunds, the assumed obligatory definiteness of the applied goal should not be a problem in such environments. Consequently, we must appeal to (yet) another mechanism to explain the ungrammaticality of (53b). The Case approach, in contrast, offers a more unified account of the distribution of peripheral arguments in Tagalog across a variety of constructions.

3.4.2 Against transitivity alternations

Other approaches view *ang* as Case, but account for its distribution differently from the current proposal. Within the literature on Tagalog and other languages with so-called Philippine-type voice/case systems, a common approach has been to view the nominal marking patterns we find through the lens of transitivity alternations. Particularly, the more cross-linguistically common notion of voice (e.g., active/passive) is often used to draw a formal distinction between AV and non-AV forms. The analyses that formalize this approach under a transformational framework commonly do so by adopting fairly standard assumptions about (anti)passives, whereby the functional heads that are linked to the transitivity alternations are assumed to also have different Case-assigning properties. These functional heads are in turn proposed to be spelled out as some subset of Tagalog voice morphology (i.e., *m-/<um>*, *-in*, *-an*, *i-*). Here, I argue against such approaches on the grounds that they fail to capture generalizations about the consistency in case marking of non-pivot arguments (as previously described in Section 2.4.3) and introduces redundancy into the analysis. I show that it is instead more straightforward to assume that voice morphology is directly tied to the assignment of only *ang*-marking, and no other Case value.²⁴

The status of case alignment in Tagalog has been the subject of much debate, and a number of proposals exist that formalize these different claims. For example, Aldridge (2004a) analyzes Tagalog as having ergative alignment (see also, e.g., Gerdts 1988 on Ilokano; de Guzman 1988 on Kapampangan and Tagalog). For her, non-AV forms like (55a-b) are syntactically transitive (including applicativized clauses). The morpheme *-in/<in>* that appears in non-AV clauses is thus analyzed as transitive v^0 , introducing the agent argument, assigning it inherent ergative Case (spelled out as *ng*), and assigning structural absolutive

²⁴For a similar argument, see Richards 2000, particularly §3.

Case to the theme (spelled out as *ang*).²⁵ On the other hand, AV forms like (55c) are treated as syntactically intransitive (including antipassives, which can be notionally transitive). Here, she argues that intransitive (and antipassive) v^0 is spelled out as *m-⟨um⟩* and does not check structural Case, so the sole argument of the clause must receive absolutive (*ang*) Case from I^0 . If present, antipassive objects are still merged as complements of V^0 , and are assigned inherent oblique (*ng/sa*) Case.

(55) BASIC CLAUSE TYPES WITH ERGATIVE AND ACCUSATIVE ALIGNMENT SHOWN

- a. I-ha~hagis ng bata ang bola sa aso.
 CV-FUT~hurl ERG child ABS ball PREP dog Ergative analysis transitive
 CV-FUT~hurl GEN child NOM ball PREP dog Accusative analysis passive
 ‘The child will throw the ball at the dog.’ CV
- b. Ha~hagis-an ng bata ng bola ang aso.
 FUT~hurl-LV ERG child OBL ball ABS dog Ergative analysis ditransitive
 FUT~hurl-LV GEN child ACC ball NOM dog Accusative analysis goal passive
 ‘The child will throw a ball at the dog.’ LV
- c. Mag-ha~hagis ang bata ng bola sa aso.
 AV-FUT~hurl ABS child OBL ball PREP dog Ergative analysis antipassive
 AV-FUT~hurl NOM child ACC ball PREP dog Accusative analysis transitive
 ‘The child will throw a ball at the dog.’ AV

Alternatively, Guilfoyle et al. (1992) propose a formalization of the view that Tagalog has an active-passive system, and thus has nominative alignment (see also, e.g., Bell 1976 on Cebuano; Kroeger 1993 on Tagalog). AV sentences like (55c) are thus active sentences, with AV morphology *m-⟨um⟩* spelling out the transitive v^0 that in turn values accusative Case (spelled-out as *ng*) on the theme.²⁶ On the other hand, non-AV sentences like (55a-55b) are passives that do not demote their agents to a *by*-phrase. This non-demoted agent receives genitive Case (also *ng*) from I^0/Infl^0 , which is spelled out as *-in/⟨in⟩*. In both cases, I^0/Infl^0 (also) values nominative Case (*ang*) on the pivot.

The question we can ask now is how Case licensing might proceed in environments without voice, such as gerunds and RPFV clauses, given that voice morphology is assumed under transitivity alternation approaches to partially carry out this function. For example, with the nominative-accusative approach of Guilfoyle et al. (1992), none of the sources of Case available in declarative contexts are found in the environments under consideration. Importantly, neither the AV morpheme *m-⟨um⟩*, which assigns accusative Case (*ng*) to the theme, nor the PV morpheme *-in/⟨in⟩*, which assigns genitive Case (also *ng*) to the agent, are possible. Thus, we might expect a different set of Case marking patterns in gerunds and RPFV, following the view for languages like English (since Abney 1987), where there is clear evidence that

²⁵Aldridge (2004a, p.96,fn.11) assumes that the PV suffix *-in* and the non-AV form of the [+BEGUN] aspect marker *⟨in⟩* (see Sec. 2.3) are allomorphs of the same morpheme.

²⁶Note that Guilfoyle et al. (1992) make explicit claims for Malagasy regarding which morphemes spell out which case-assigning heads, but they are not as specific for Tagalog. That is, they do not say anything concrete about the function of the voice morphemes *m-⟨um⟩*, *-in*, *-an*, *i-* in Tagalog, but they do claim that at least a subset of the counterpart morphemes in Malagasy are responsible for case assignment. Here, I assume for the sake of argument that the Tagalog morphemes share the same function as their Malagasy equivalents. Also, while their analysis predates the introduction of vP , it is relatively straightforward to recast the analysis in more modern terms.

alternate sources of Case licensing are active. For example, with a Poss-ing gerund such as (56a), subjects appear in the possessive form while objects are marked with *of*. Contrary to this expectation, however, the relevant arguments in (57) do bear *ng*-marking, and there is no strong evidence that this marking reflects underlyingly different Case licensing processes from those in voice-marked environments, following the discussion in Section 2.4.3.²⁷ This issue may be resolved by proposing that alternative sources for these Case values are available in gerunds and RPFV, but without independent motivation or evidence, this would simply introduce redundancy into the analysis, particularly because multiple duplicate sources of Case (i.e., for the agent and for the theme) must be proposed.

(56) NOMINAL MARKING IN ENGLISH GERUNDS

- a. [The teacher's reprimanding of Larry] was unfortunate.
- b. The teacher reprimanded Larry.

(57) NOMINAL MARKING IN TAGALOG VOICELESS ENVIRONMENTS

- a. ang pag-hagis ni Lourdes ng bola sa aso
 NOM GER-hurl GEN.P Lourdes GEN ball OBL dog
 ' Lourdes's throwing of a ball at the dog '
- b. Kaha~hagis lang ni Lourdes ng bola sa aso.
 RPFV-hurl only GEN.P Lourdes GEN ball OBL dog
 ' Lourdes has just thrown a ball at the dog. '

For the ergative-absolutive approach put forth by Aldridge (2004a), the problem is similar, although not as intractable. Following this approach, *ng*-marking on themes in gerunds and RPFV can be understood as an instance of the proposed inherent oblique Case (*ng/sa*) assigned to these arguments in voice-marked contexts (specifically in intransitives/antipassives). The problem, as it turns out, is the licensing of the external argument. In voice-marked environments, licensing is achieved through ergative Case (*ng*) assignment by transitive v^0 , spelled out as *-in/<in>*. However, this morpheme is unavailable in voiceless verbal environments, so we must propose an alternative. Here, we may appeal to the genitive-ergative homophony in Tagalog, and posit that the Case assigned to external arguments in these environments is instead genitive Case (also *ng*) from a nominal functional head. This approach coincides well with the nominal properties exhibited by gerunds. This idea is less clearly applicable to RPFV clauses, although supporting evidence can potentially be found in examples like (58); see also (17c). Here, we see an example of an oblique-marked phrase that is morphologically (although not obviously semantically) similar if not identical to the RPFV form, having the same *ka-* + CV-reduplication. If the RPFV form can be related to this more nominal use, then there would be a stronger case for arguing that the RPFV form is indeed nominal at some stage of its derivation. This issue requires further study, and is left for future work.

²⁷Interestingly, the situation in Tagalog appears to contrast with another language that is discussed by Guilfoyle et al. (1992), Malagasy. Ntelitheos (2010) points out that event-denoting gerundive nominals in this language are derived with a prefix *f-* attaching to the Circumstantial Topic form of a verb, which itself bears both the Actor Topic and Theme Topic affixes, *an-* and *-na*. These affixes are roughly equivalent to the Tagalog AV and PV affixes, and are proposed by Guilfoyle et al. to assign accusative Case to the theme and genitive Case to the agent, respectively, allowing a peripheral argument to surface with nominative Case.

- (58) Na-matay ang mga halaman sa [kadi~dilig ni Juan nito].
 PFV-die NOM PL plant OBL ka.RED~water GEN.P Juan PROX.GEN
 ‘The plants died from [Juan’s (over)watering them].’

Thus, we have seen the main problem with tying the Tagalog voice morphemes to classical mechanisms for deriving alternations in voice (in the broader sense of the term) or transitivity. As this kind of approach assumes that different voice morphemes realize various functional heads that assign particular Case values, constructions where none of these morphemes appear (e.g., gerunds, RPFV clauses) pose the question of how their dependents are licensed and furthermore why the Case they receive is the same as what is found in environments where voice morphemes *are* present. The most straightforward answer to this question on this type of approach is to propose alternative Case licensing heads, but I have argued that these introduce redundancy into the analysis to varying degrees. It is therefore more parsimonious to decouple the Tagalog voice morphemes from such alternations, leaving it to only be responsible for assigning nominative Case, and attributing the licensing of genitive Case to other syntactic heads.

3.4.3 Against default/last-resort case

More recently, Erlewine et al. (2019) propose a typology of nominal licensing strategies among different languages that exhibit an Austronesian/Philippine-type voice system. Specifically, they propose parameters along which these languages vary with regards to how nominals which are not pivots are licensed. They characterize Tagalog as a language that lacks structural accusative case and also makes use of a last resort licensing mechanism of genitive Case insertion. This parameter setting is argued to result in the pattern we have seen (recall Section 2.4.3) where nominal clausal dependents that do not receive nominative Case must be licensed by genitive instead, regardless of their thematic role.²⁸

- (59) NON-NOMINATIVE NOMINALS ARE MARKED GENITIVE
- a. Nag-luto ako **ng spaghetti** para sa mga trabahador.
 AV.PFV-cook 1SG.NOM GEN spaghetti for OBL PL worker
 ‘I cooked spaghetti for the workers’
 - b. Ni-luto **ko** ang spaghetti para sa mga trabahador.
 PFV-cook(PV) 1SG.GEN NOM spaghetti for OBL PL worker
 ‘I cooked the spaghetti for the workers’
 - c. I-p<in>ag-luto **ko ng spaghetti** ang mga trabahador.
 CV-<PFV>pag-cook 1SG.GEN GEN spaghetti NOM PL worker
 ‘I cooked spaghetti for the workers’

This approach is attractive for Tagalog as it is another way to capture the intuitive notion that *ng* appears on nominals when they are not marked *ang*. However, it does not predict the correct behavior when it comes to the behavior of applied arguments as discussed in Section 3.3, essentially resulting in the same problem as the one discussed in Section 3.4.1.

²⁸Recall from Sec. 2.4.2 that oblique or *sa*-marked phrases are prepositional.

Recall that in Section 3.3, we saw evidence from Rackowski (2002) for peripheral arguments (e.g., goals, benefactives, etc.) being introduced as applied objects, and not as adjuncts, whenever appearing as the pivot of a clause, as we see with the beneficiary argument *ang mga trabahador* ‘(for) the workers’ in (59c). However, we also saw that in adopting such applicative structures, the question arises of why we do not find non-pivot applied objects. With respect to this question, I proposed in Section 3.3 that applied objects are not assigned Case in their base positions, and must therefore be targeted for Agree by *Agr*⁰ which then values nominative Case (i.e., *ang*) on them. This explanation is incompatible with the default case approach described here as we would *a priori* expect it to be possible for such applied objects to be licensed by last-resort *ng*-marking.

As discussed in Section 3.4.1 for approaches that treat *ang* as something other than Case, we might assume that in constructions with applied objects, there is a secondary mechanism that forces applied objects to become the closest goal for the syntactic head assigning *ang* (*C*⁰/*CT*⁰ for Erlewine et al. 2019). The absence of *ng*-marked applied objects in voice-marked contexts could then be understood as a kind of accident resulting from this mechanism. This in turn predicts that, all things being equal, non-pivot applied objects *should* be possible in environments that do not have pivots (i.e., that are voiceless). The gerund examples in (60) show that this prediction is not borne out, parallel to what we saw in Section 3.4.1.

(60) NO APPLICATIVES WITH GERUNDS

- a. *ang paglu~luto ko ng spaghetti para sa mga trabahador*
 NOM GER~COOK 1SG.GEN GEN spaghetti for OBL PL worker

‘my cooking of spaghetti for the workers’

- b. **ang paglu~luto ko ng spaghetti ng mga trabahador*
 NOM GER~COOK 1SG.GEN GEN spaghetti GEN PL worker

Intended: ‘my cooking of spaghetti for the workers’ / ‘my cooking the workers (some) spaghetti’
 Grammatical as: ‘my cooking of the workers’ spaghetti’

In contrast, the current proposal accounts for restriction shown in (60) as a licensing problem. Applicative objects are not licensed in their base positions, and so must receive Case externally. In gerunds, there is no such external source of Case, whether from a syntactic head or as a last-resort mechanism, so the applied object remains unlicensed.

3.5 *Agr*⁰ in other clausal constructions

So far, we have considered constructions in Tagalog that bear morphology corresponding to functional heads on the extended verbal projection. In particular, I discussed constructions that bear valency changing morphemes (*v*⁰/*App*⁰), the Tagalog voice morphemes (*Agr*⁰), and aspect morphology (*I*⁰). Within this particular corner of Tagalog, we saw that nominative marking only appears when *Agr*⁰ does (Section 3.1). Examples that show this correlation are given in (61), featuring a fully inflected verb, an aspectless verb, and a voiceless (and aspectless) gerund. The formal account of this correlation has been the focus of this chapter so far.

(61) THE PRESENCE OF NOMINATIVE IS CONDITIONAL ON AGR⁰

- a. I-pa~pa-basa ko sa mga mag-aarál ang artikulo=ng ito.
 CV-FUT~CAUS-read 1SG.GEN OBL PL student NOM article=LK PROX
 ‘I will have the students read the article.’ Fully inflected verb
- b. Ma-ganda=ng [i-pa-basa sa mga mag-aarál ang artikulo=ng ito].
 ADJ-nice=LK CV-CAUS-read OBL PL student NOM article=LK PROX
 ‘This article is good (for us) to have the students read.’ Aspectless verb
- c. T<in>igil-an na ng mga guro ang [pag-pa~pa-basa nila sa mga mag-aarál ng
 <PFV>stop-LV already GEN PL teacher NOM pag-RED~CAUS-read 3PL.GEN OBL PL student NOM
 artikulo=ng ito].
 article=LK PROX
 ‘The teachers have stopped their having the students read this article.’
 Gerund (aspectless, voiceless)

In first pointing out this correlation, I was careful to limit the range of data considered to “verbally” predicated constructions, with the operative notion of “verbal” stated in (62).

(62) OPERATIVE DEFINITION OF A VERB

A construction is verbal if it bears some subset of the extended verbal projection (i.e., v^0 , Appl⁰, Agr⁰, and I⁰).

This distinction was drawn because the dependence of nominative marking on the presence of the voice morphemes *m-/<um>*, *-in*, *-an*, *i-* clearly does not hold in other areas of Tagalog. Clauses with other types of predicates routinely mark nominative on their subjects despite not bearing voice morphology. In this section, I discuss the behavior of these constructions with regards to how nominative Case is assigned.

When we consider Tagalog clauses with predicates that are (at least intuitively) non-verbal, as shown below in (63), it is fairly clear that no voice morphology (or other verbal morphology, for that matter) appears on the predicate, yet the subject is nevertheless marked nominative. Recall that Tagalog is strongly predicate-initial and that there is no overt copula.

- (63) a. Pusakal³⁰ ang pusa ni Eddie.
 stray.cat NOM cat GEN.P Eddie
 ‘Eddie’s cat {is/was} a stray.’ Nominal Predicate
- b. Na-sa labas ng kwarto ang pusa ni Eddie.
 PRED-OBL outside GEN room NOM cat GEN.P Eddie
 ‘Eddie’s cat is outside the room.’ Prepositional Predicate
- c. Ma-taba ang pusa ni Eddie.
 ADJ-fat NOM cat GEN.P Eddie
 ‘Eddie’s cat is fat.’ Adjectival Predicate

³⁰Pusakal in (63a) is a portmanteau of *pusa* ‘cat’ and *kalye* ‘street’. Also attested is *askal* ‘stray dog’ (*aso* ‘dog’ + *kalye* ‘street’).

In the nominally predicated example (63a), the subject *pusa ni Eddie* ‘Eddie’s cat’ bears nominative marking despite the predicate *pusakal* ‘stray cat’ not bearing any overt Tagalog voice morphology (*m-/<um>, -in, -an, i-*), or in fact, any morphology resembling what we find on verbs, as defined in (62). On the other hand, affixes like *na-* and *ma-* resembling verbal morphology do appear on the adjectivally and prepositionally predicated examples (63b-c). However, these do not exhibit the same behavior as the morphology we find on verbs, and are instead invariant. For example, these forms do not inflect for aspect, so neither predicate has an imperfective form (e.g., **na-sa~sa labas* and **na-ta~taba*).³¹

In formalizing the behavior of these clause types, I assume that adjectival predicates have a different account from the others. This is because certain types of adjectives exhibit more complex behavior that is somewhat reminiscent to what we see in the verbal domain. As (64) shows, alternations in inflectional morphology (*ma-* vs *napaka-*) on an adjective correlate with whether or not their subjects receive nominative Case. This behavior is similar to what we have seen with the voice morphemes in the verbal domain.

- | | |
|---|---|
| (64) a. Ma -bilis ang <u>kabayo</u> =ng <u>ito</u> .
ADJ-fast NOM horse=LK PROX
‘This horse is fast.’ | b. Napaka -bilis ng <u>kabayo</u> =ng <u>ito</u> .
very-fast GEN horse=LK PROX
‘This horse is very fast.’ |
|---|---|

Thus, I focus first on nominal and prepositional phrase predicates, which are less complex than adjectives in that they do not exhibit parallel alternations in morphological form conditioning alternations in Case assignment. To account for these constructions I propose the following. First, I claim that Agr⁰ is still generally present in all non-verbally predicated environments (including adjectivally predicated ones). That is, I take the function of Agr⁰ to be invariant within Tagalog syntax. Second, I assume that predication with nominal and prepositional phrases is mediated by PredP. Pred⁰ selects as its complement the semantic predicate of the clause, which in this case is an NP or a PP. On the other hand, it selects a DP as its specifier to serve as the semantic subject. In turn, Agr⁰ takes PredP as its complement and probes into it for a DP bearing [PIVOT] to agree with. In the cases we are considering here, there is only one available target: the semantic subject in Spec-PredP, which moves to Spec-AgrP.³² The resulting AgrP structure is (66), corresponding to the nominally predicated example sentence (65a). The prepositionally predicated examples (65b-c) would have parallel structures.

- | |
|--|
| (65) a. Guro sa aralí[n]=ng panlipunan si Eddie.
teacher OBL lesson=LK for.society NOM.P Eddie
‘Eddie is a teacher of social studies.’ |
| b. Na-sa opisina si Eddie.
PRED-OBL office NOM.P Eddie
‘Eddie is in the office.’ |

³¹CV-reduplication is possible with adjectives, but reflects (optional) plural marking, as illustrated in (i). See also Sabbagh 2005, chap.4 for further discussion of behaviors that distinguish adjectives from verbs in Tagalog.

(i) Ma-ta~taba ang *(mga) pusa ni Eddie.
ADJ-PL~fat NOM PL cat GEN.P Eddie
‘Eddie’s {cats are/*cat is} fat.’

³²The complement of Pred⁰ can also be another DP, which would result in specificational or equational copular clauses (see Mikkelsen 2005b). These types of constructions are discussed in Section 5.2.

- c. (Para) Kay Eddie ang bolpe[n]=ng ito.
 for OBL.P Eddie NOM pen=LK PROX
 ‘This pen is {Eddie’s/for Eddie}.’

(66) AGRP STRUCTURE FOR COPULAR CLAUSES

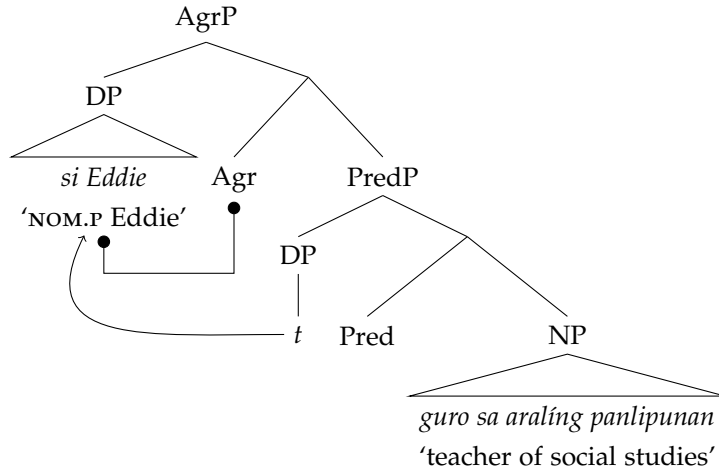

Once in Spec-AgrP, the semantic subject DP receives abstract nominative Case from Agr⁰ in the same fashion as pivots do in verbally predicated clauses. For the derivations considered in this section, I assume that Case from Agr⁰ is in fact the second Case value assigned to the semantic subject, the first being an(other) instance of nominative Case, which Pred⁰ assigns to its specifier position. That the semantic subject receives two instances of nominative Case over the course of the derivation is allowed under the MCC analysis adopted here, but has no significant implications for the specific derivations considered in this section. That is, we arrive at the same results even if Pred⁰ assigns no Case. However, this assumption will become relevant in Section 5.2, where we consider the behavior of DP-DP copular clauses in the context of DP focus constructions.

Following Massam and Smallwood (1997) and Massam (2000), I assume that the relevant EPP feature on I⁰ in Tagalog is not [*u*D] (as it would be in English) but [*u*PRED]. I⁰ thus probes its c-command domain for this feature and finds the PredP. PredP then undergoes remnant movement to Spec-IP, thus deriving the predicate-initial default word order we find in Tagalog. This step of the derivation is illustrated by (67).

(67) IP STRUCTURE FOR A COPULAR CLAUSE

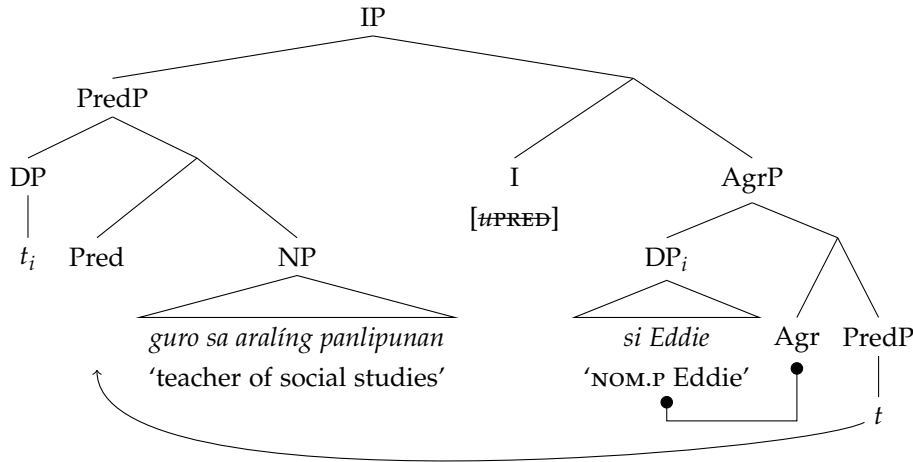

For adjectives, I follow the proposal put forth by Sabbagh (2005, chap.4), who discusses issues surrounding adjectival argument structure in Tagalog. He observes that the availability of some adjectival forms, particularly *napaka-* in (64b), is dependent on argument structural properties of the adjective, specifically on whether the subject of an adjective is an external or an internal argument (i.e., unergative vs unaccusative adjectives). Examples of this contrast are shown by the pairs (68) and (69). Notice that while the *napaka-* form is grammatical in (68b), it is not in (69b).

(68) UNERGATIVE ADJECTIVES

- a. {Ma-ganda/Pangit} ang bulaklak.
 ADJ-beauty ugly NOM flower
 'The flower is {pretty/ugly}.'
- b. Napaka-{ganda/pangit} ng bulaklak.
 very- beauty ugly GEN flower
 'The flower is very {pretty/ugly}.'

(69) UNACCUSATIVE ADJECTIVES

- a. {Tulog/pagod} ang bata.
 asleep tired NOM child
 'The child is {asleep/tired}.'
- b. *Napaka-{tulog /pagod} ng bata.
 very- asleep tired GEN child
 ('The child is {fast asleep/very tired}.'

Sabbagh argues that the contrast between (68) and (69) is indeed tied to argument-structural differences, and not, for example, a more semantic factor such as the gradability of the individual predicates. Following this, he proposes that the structure of adjectival predicates is closer to that of verbal predicates, such that adjectival phrases have a projection *aP*, parallel to *vP*, that introduces the external argument. I adopt this structure and further assume that *aP* is selected by Agr⁰, which subsequently triggers movement of the subject to its specifier and assignment of nominative Case. This is the same movement that occurs with nominal and prepositional predicates. (70) illustrates this structure for the case of a regular declarative adjective example (68a).

(70) AGRP STRUCTURE WITH AN UNERGATIVE ADJECTIVE

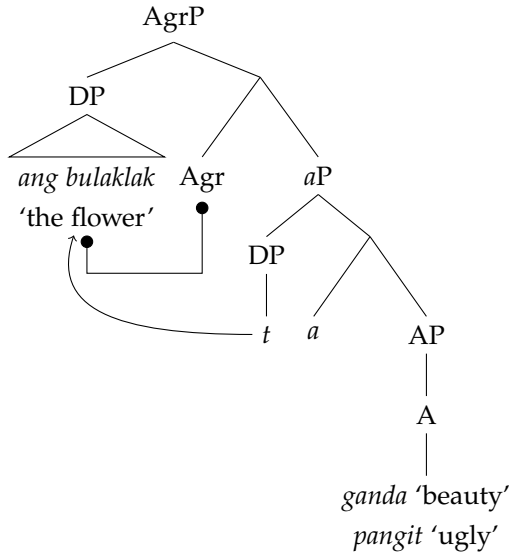

To derive the predicate-initial word-order, I assume that A^0 undergoes head movement to I^0 as in verbally predicated clauses, as (71) shows.

(71) IP STRUCTURE WITH AN UNERGATIVE ADJECTIVE

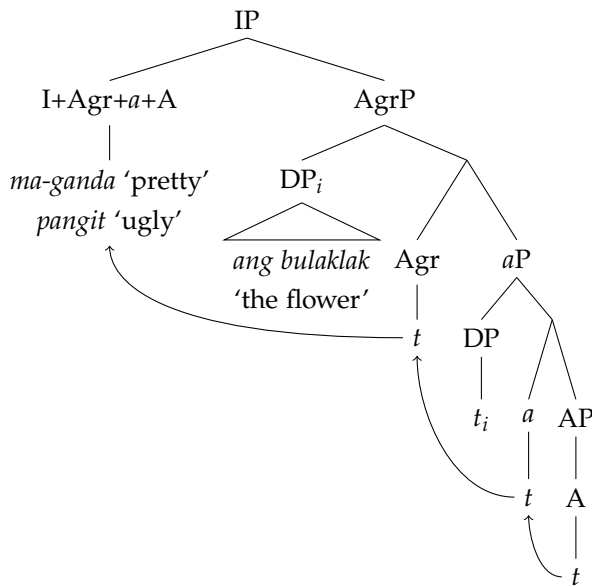

I assume for concreteness that the *ma-* morpheme that appears on most unergative adjectives is the joint spell-out of Agr^0 and the a^0 that introduces external arguments. This partially follows Sabbagh's (2005, p.140) proposal that *ma-* spells out a^0 . The added component of Agr^0 is proposed to account for the alternation between *ma-* and *napaka-* that we observe in (68). This alternation is addressed in more detail later in Section 6.5, where I discuss these alternations in the context of A' -dependencies.

The issue of *ma-* and *napaka-* aside, it is clear from the data that the assumption about how *ma-* surfaces does not properly account for unergative adjectives like *pangit* 'ugly', which do not take *ma-*.

For the purposes of this thesis, I assume that this contrast is lexically specified, as it is not immediately obvious what property of a given unergative adjectival root determines whether or not it takes *ma-*.³³ In general, the morphological patterns exhibited by adjectives turn out to be relatively complex in their own right, and deserve separate study. I refer the interested reader to Schachter and Otnes 1972, chap.4 and Sabbagh 2005, chap.4 for more specific discussion and analysis.

3.6 Chapter summary

In this chapter, I have developed an analysis for the Case system of Tagalog and the pivot marker *ang* (and its lexically conditioned allomorphs).

With regards to Case, I adopted the model of abstract Case, whereby Case is assigned by syntactic heads to DPs upon (external or internal) Merge, and is subsequently spelled out as morphological case. To account for the underlying patterns of nominal marking discussed in Section 2.4.3, I proposed that various heads in the argument-structural domain assign abstract genitive Case to core arguments, which is spelled out as *ng* and its allomorphs. Specifically, agentive v^0 assigns inherent genitive Case to agents, while themes receive this Case from either V^0 or Appl^0 .

With regards to the pivot marker *ang* and its allomorphs, two main points were argued. First, I argued that *ang*-marking is assigned by a functional head Agr^0 , which occurs above vP but below IP. This functional head probes its c-command domain for a DP bearing a discourse-motivated feature [PIVOT], and moves this DP to its specifier position. In verbally predicated clauses, Agr^0 is spelled out as one of the Tagalog voice morphemes *m-/<um>*, *-in*, *-an*, and *i-* as a result. Second, I proposed that *ang*-marking itself is the morphological spell-out of abstract nominative Case.

Given these two aspects of the proposal, an apparent incompatibility was pointed out, such that some arguments (i.e., agents and themes) would receive two Case values, genitive and nominative, when they surfaced as the pivot. I reconciled this incompatibility by adopting Béjar and Massam's (1999) Multiple Case Checking analysis, which proposes that abstract Case in some languages must remain local to its assigning head, allowing a DP to be assigned multiple values of Case through the course of a derivation if that DP undergoes movement to a different position. The result of such multiple Case assignment is that the highest value of abstract Case is what gets spelled out morphologically. Furthermore, I showed that this Case-based view of *ang*-marking is crucially necessary (not simply possible) by demonstrating that it provides a principled account for the restricted distribution of applied objects in this language. These objects are introduced in a position with no available abstract Case, so nominative Case from Agr^0 , spelled out as *ang*-marking, is the only source of licensing.

³³Impressionistically speaking, there appears to be a tendency for those adjectives that do not take *ma-* to be intuitively "negative", although counterexamples are easily found. Compare, for instance, the examples in (i) with those in (ii).

- | | |
|--|--|
| (i) a. <i>ma-ganda</i> 'beautiful, good' vs <i>pangit</i> 'ugly' | (ii) a. <i>bago</i> 'new' vs <i>luma</i> 'old' |
| b. <i>ma-bait</i> 'kind, well-behaved' vs <i>bastos</i> 'rude' | b. <i>mura</i> 'cheap' vs <i>mahal</i> 'expensive' |
| c. <i>ma-taba</i> 'fat' vs <i>payat</i> 'thin' | c. <i>ma-buti</i> 'good' vs <i>ma-samâ</i> 'bad, evil' |
| d. <i>ma-tangkad</i> 'tall of stature' vs <i>pandak</i> 'short of stature' | d. <i>ma-linis</i> 'clean' vs <i>ma-rumi/ma-dumi</i> 'dirty' |
| e. <i>ma-sipag</i> 'hardworking' vs <i>tamad</i> 'lazy' | e. <i>ma-init</i> 'hot' vs <i>ma-lamig</i> 'cold' |
| f. <i>ma-dalas</i> 'often' vs <i>bihira</i> 'seldom' | f. <i>ma-taas</i> 'high' vs <i>ma-bâbâ</i> 'low' |

The proposal developed in this chapter establishes general domains for the distribution of Case assignment in Tagalog. Syntactic heads within the argument-structural domain (v^0 , V^0 , Appl^0) assign genitive Case, while those outside of it (Agr^0 and Pred^0) assign nominative. In Chapter 5, I extend this general picture of the distribution of Case by proposing that syntactic heads in the clausal left periphery *do not* assign abstract Case. This lack of abstract Case will be shown to have consequences for the behavior of A'-dependency formation in Tagalog, which constitute the main empirical focus of this thesis. Before discussing this, however, I first turn to an overview of these A'-dependencies in Chapter 4.

Chapter 4

A survey of A'-dependencies in Tagalog

This dissertation focuses on the analysis of a two types of A'-dependencies in Tagalog, namely: RELATIVE CLAUSES and FOCUS CONSTRUCTIONS, the latter of which include *wh*-questions. As previewed in Chapter 1, the formation of these dependencies in Tagalog involves distinct constructions conditioned on whether the dependency targets a DP or a non-DP.¹ Thus, we have four constructions of interest for forming A'-dependencies resulting from all logical combinations of dependency type and dependency target, as exemplified in (1-2).

(1) TAGALOG RELATIVE CLAUSES

- a. patatas **na** ka~kain-in ng guro sa kusina
potato LK FUT~eat-PV GEN teacher OBL kitchen
'potatoes that the teacher will eat in the kitchen' DP relative clause = Linker RC
- b. lugar **kung saan** ka~kain-in ng guro ang patatas
place if where FUT~eat-PV GEN teacher NOM potato
'place where the teacher will eat the potatoes' Non-DP relative clause = *Kung*-RC

(2) TAGALOG FOCUS CONSTRUCTIONS

- a. Ang patatas ***(ang)** ka~kain-in ng bisita sa kusina.
NOM potato NOM FUT~eat-PV GEN guest OBL kitchen
'What the guest will eat in the kitchen are the potatoes.' DP focus construction = Pseudocleft
- b. Sa kusina ***(ang)** ka~kain-in ng bisita ang patatas.
OBL kitchen NOM FUT~eat-PV GEN guest NOM potato
'It's in the kitchen that the guest will eat potatoes.'
Non-DP focus construction = Focus Fronting

The different constructions can be readily identified from their surface structures. For the relative

¹A number of other constructions, such as *ay*-inversion and other forms of topicalization, appear to not have such a distinction. These will not be considered here, but see Sec. 7.3.4 for more discussion.

clauses in (1), we see a difference in the material (in boldface) mediating between the nominal head and the relative clause modifier. DP relative clauses, which I refer to as **LINKER RELATIVE CLAUSES (RCs)**, use the linker morpheme *na/=ng*. In contrast, non-DP relative clauses have a complementizer *kung* along with an overt *wh*-expression, so I refer to these as *kung* **RELATIVE CLAUSES**. For focus constructions (2), the difference lies in the presence or absence of material in between the clause-initial focus constituent and the rest of the clause (i.e., the presuppositional statement). DP focus must have a determiner *ang* in this position, whereas this determiner is ungrammatical with non-DP focus (boldface). I refer to these structures as **PSEUDOCLEFTS** and **FOCUS FRONTING**, respectively.

This chapter provides an overview of these different constructions while showing that they are distinct from each other, in terms of both their underlying structure and their distribution. For the focus constructions in particular, I argue in Section 4.2 that the descriptive labels just introduced should be understood as being reflective of their syntactic structure. That is, DP focus has the structure of a pseudocleft, which I take to mean a copular clause structure where the subject is a DP (headless) relative clause and the predicate is a referential DP. In contrast, non-DP focus involves more typical movement to a clause-peripheral position (following Aldridge 2002; Mercado 2004). This chapter thus motivates the main theoretical goal of the thesis, which is to account for the structural differences between the A'-dependency formation strategies in Tagalog summarized with schematic representations in Table 4.1. Concrete analysis of these structural differences is provided in Chapters 5 and 7.

Table 4.1: Types of A'-dependencies in Tagalog

	RELATIVE CLAUSE	FOCUS CONSTRUCTION
DP	Linker Relative ⇒ NP LK [CP ...]	Pseudocleft ⇒ FOC/WH (*ang) [CP ...]
NON-DP	<i>Kung</i> Relative ⇒ NP <i>kung WH</i> [CP ...]	Focus Fronting ⇒ FOC/WH (*ang) [CP ...]

Before proceeding, the link between *wh*-questions and focus constructions in Tagalog mentioned at the beginning of this chapter should be spelled out more concretely. Following previous literature (Schachter and Otones 1972; Richards 1998; Aldridge 2002; Mercado 2004; Gerassimova and Sells 2008), I assume that *wh*-questions in Tagalog are structurally parallel to focus constructions, and differ only in that the former feature an interrogative phrase in clause-initial position, while the latter feature a non-interrogative one. As we will see in this chapter, the structural parallelism can be seen in how *wh*-questions and focus constructions show the same sensitivity to target type (DP vs non-DP) and behave identically with respect to a number of syntactic diagnostics. For example (3), modified from (2), shows that we can replace the focus constituent with a *wh*-expression of the same category, and that the obligatory presence or absence of *ang* is preserved.

(3) TAGALOG FOCUS CONSTRUCTIONS

- a. {Ang patatas/**Ano** } *(**ang**) ka~kain-in ng bisita sa kusina.
 NOM potato what[NOM] NOM FUT~eat-PV GEN guest OBL kitchen
 'What the guest will eat in the kitchen are the potatoes.'
 'The one that the guest will eat in the kitchen is what?' DP focus or *wh*-question = Pseudocleft
- b. {Sa kusina/Saan } (***ang**) ka~kain-in ng bisita ang patatas.
 OBL kitchen where(OBL) NOM FUT~eat-PV GEN guest NOM potato
 'It's in the kitchen that the guest will eat potatoes.'
 'Where will the guest eat potatoes?' Non-DP focus or *wh*-question = Focus Fronting

4.1 Distribution

4.1.1 Basic overview

It is well-established that Tagalog privileges the nominative-marked pivot for the formation of A'-dependencies (see for example Schachter 1976; Kroeger 1993; Nakamura 1993; Kaufman 2009 for a range of discussion and analyses of this property). Thus, given the pair of baseline declarative sentences in (4), only the second one with *inilagay* 'put (cv)' allows relativization of the theme, as shown in (5). This is because *inilagay*, not *naglagay*, is the voice form that results in a theme pivot. The examples in (6) show the same pattern for DP focus constructions.

(4) BASELINE VOICE ALTERNATION IN TAGALOG

- a. **Nag-lagay** ang mag-aarál ng lapis sa lamesa.
 AV.PFV-put NOM student GEN pencil OBL table
 'The student put a pencil on the table.' 'put' AV → Agent NOM
- b. **I-ni-lagay** ng mag-aarál ang lapis sa lamesa.
 CV-PFV-put GEN student NOM pencil OBL table
 'The student put the pencil on the table.' 'put' CV → Theme NOM

(5) DP RELATIVE CLAUSES ARE RESTRICTED BY VOICE

- a. *lapis na [**nag-lagay** ang mag-aarál sa lamesa]
 pencil LK AV.PFV-put NOM student OBL table
 Intended: 'pencil that the student put on the table' *'put' AV + Theme Linker RC
- b. lapis na [**i-ni-lagay** ng mag-aarál sa lamesa]
 pencil LK CV-PFV-put GEN student OBL table
 'pencil that the student put on the table' 'put' CV + Theme Linker RC

(6) DP FOCUS IS RESTRICTED BY VOICE

- a. *{Ang itim na lapis /(Ng) Ano} ang [**nag-lagay** ang mag-aarál sa lamesa].
 NOM black LK pencil GEN what NOM AV.PFV-put NOM student OBL table

Intended: 'What the student put on the table is the black pencil.'

Intended: 'What did the student put on the table?' *'put' AV + Theme Pseudocleft

- b. {Ang itim na lapis /Ano } ang [**i-ni-lagay** ng mag-aarál sa lamesa].
 NOM black LK pencil what.NOM NOM CV-PFV-put GEN student OBL table

'What the student put on the table is the black pencil.'

'What did the student put on the table?' ✓'put' CV + Theme Pseudocleft

In contrast to the relatively restricted behavior of DP dependencies, non-DP dependencies freely *ignore* voice. Thus, for the same pair of baseline declaratives in (4), we see in (7) that both allow relativization of the oblique goal argument. Again, the same pattern holds for non-DP focus constructions, as shown in (8). This freedom has been argued to be due to the relative structural height of the target constituents as adjuncts (see e.g., Kaufman 2009), but this explanation does not account for the accessibility of the presumably low goal argument of *lagay* 'put' illustrated here

(7) NON-DP RELATIVE CLAUSES ARE NOT RESTRICTED BY VOICE

- a. lamesa kung saan [**nag-lagay** ang mag-aarál ng lapis]
 table if where AV.PFV-put NOM student GEN pencil

'table where the student put a pencil'

✓'put' AV + Oblique *Kung*-RC

- b. lamesa kung saan [**i-ni-lagay** ng mag-aarál ang lapis]
 table if where CV-PFV-put GEN student NOM pencil

'table where the student put the pencil'

✓'put' CV + Oblique *Kung*-RC

(8) NON-DP FOCUS IS NOT RESTRICTED BY VOICE

- a. {Sa ma-bábà=ng lamesa/Saan } [**nag-lagay** ang mag-aarál ng lapis].
 OBL ADJ-low=LK table where AV.PFV-put NOM student GEN pencil

'It's on the low table that the student put a pencil.'

'Where did the student put a pencil?'

✓'put' AV + Oblique Focus Fronting

- b. {Sa ma-bábà=ng lamesa/Saan } [**i-ni-lagay** ng mag-aarál ang lapis].
 OBL ADJ-low=LK table where CV-PFV-put GEN student NOM pencil

'It's on the low table that the student put the pencil.'

'Where did the student put the pencil?'

✓'put' CV + Oblique Focus Fronting

4.1.2 Non-overlapping distribution

We have just seen that A'-dependencies targeting DPs can be formed using the linker RC and pseudocleft (i.e., with *ang*) constructions, and that these dependencies show a sensitivity to the Tagalog voice system

to exhibit the well-known pivot-only restriction. In contrast, A'-dependencies targeting non-DPs can be formed using the *kung*-RC and focus fronting (i.e., without *ang*) constructions, and ignore the voice system.

Significantly, the non-DP constructions cannot be used to form DP-targeted A'-dependencies. In other words, the comparatively freer (i.e., voice-ignoring) distribution of *kung*-RCs and focus fronting that we have seen does not extend to targeting DPs. We can see this incompatibility in (9-10), which show attempts at targeting a theme *lapis* 'pencil'. We see that the theme DP cannot be relativized, questioned, or focused with the non-DP strategies *regardless of whether or not this argument is the pivot* (i.e., regardless of the voice form of the verb).

(9) *Kung*-RCs CANNOT TARGET DPs

- a. **lapis kung ano* (ang) [nag-lagay ang mag-aarál sa lamesa]
 pencil if what NOM AV.PFV-put NOM student OBL table
 Intended: 'pencil that the student put on the table'
- b. **lapis kung ano* (ang) [i-ni-lagay ng mag-aarál sa lamesa]
 pencil if what NOM CV-PFV-put GEN student OBL table
 Intended: 'pencil that the student put on the table'

(10) FOCUS FRONTING CANNOT TARGET DPs

- a. *{Ng lapis /(Ng) Ano} Ø [nag-lagay ang mag-aarál sa lamesa].
 GEN pencil GEN what AV.PFV-put NOM student OBL table
 Intended: 'It's a pencil that the student put on the table.'
 Intended: 'What did the student put on the table?'
- b. *{Ang lapis /Ano } Ø [i-ni-lagay ng mag-aarál sa lamesa].
 NOM pencil what.NOM CV-PFV-put GEN student OBL table
 Intended: 'It's the pencil that the student put on the table.'
 Intended: 'What did the student put on the table?'

Similarly, (11-12) show that the DP constructions (i.e., linker RCs and pseudoclefts) cannot be used to form dependencies targeting non-DPs. This is perhaps less surprising given that the target in these examples is not the pivot of the clause, and we have seen that the DP constructions exhibit the pivot-only restriction.

(11) LINKER RCs CANNOT TARGET NON-DPs

- a. *lamesa=**ng** [nag-lagay ang mag-aarál ng lapis]
 table=LK AV.PFV-put NOM student GEN pencil
 Intended: 'table where the student put a pencil'
- b. *lamesa=**ng** [i-ni-lagay ng mag-aarál ang lapis]
 table=LK CV-PFV-put GEN student NOM pencil
 Intended: 'table where the student put the pencil'

(12) PSEUDOCLEFTS CANNOT TARGET NON-DPs

- a. *{Sa ma-bábà=ng lamesa/Saan } **ang** [nag-lagay ang mag-aarál ng lapis].
 OBL ADJ-low=LK table where NOM AV.PFV-put NOM student GEN pencil

Intended: 'What the student put a pencil on is the low table.'

Intended: 'Where did the student put a pencil?'

- b. *{Sa ma-bábà=ng lamesa/Saan } **ang** [i-ni-lagay ng mag-aarál ang lapis].
 OBL ADJ-low=LK table where NOM CV-PFV-put GEN student NOM pencil

Intended: 'What the student put the pencil on is the low table.'

Intended: 'Where did the student put the pencil?'

Three types of evidence further support the characterization of this asymmetry as DP versus non-DP, and not, for example, as argument versus adjunct (contra Gerassimova and Sells 2008). First, we see that non-DP arguments form A'-dependencies like other non-DPs. For example, we saw in (7-8) that the goal argument of *lagay* 'put' is relativized with *kung*-RCs and undergoes focus fronting. As evidence for the argumenthood of this goal, (13) shows that it is typically obligatory.

(13) OBLIGATORY PP GOAL FOR *lagay* 'PUT'

- a. Nag-lagay ang mag-aarál ng lapis *(sa lamesa).
 AV.PFV-put NOM student GEN pencil OBL table

'The student put a pencil on the table.'

- b. I-ni-lagay ng mag-aarál ang lapis *(sa lamesa).
 CV-PFV-put GEN student NOM pencil OBL table

'The student put the pencil on the table.'

Second, we find an interaction with the Tagalog voice system. Recall from Section 3.1 that peripheral arguments and adjuncts in Tagalog clauses can be picked out by the voice system to be the pivot of the clause. For example, (14) shows the goal *lamesa* 'table' with *ang*-marking; compare this with previous examples such as (13) where it is *sa*-marked.

- (14) **Ni-lagy-an** ng mag-aarál ng lapis ang lamesa.
 PFV-put-LV GEN student GEN pencil NOM table

'The student put a pencil on the table.'

'put' LV → Goal pivot

In Section 3.3, such alternations between truth-conditionally similar constructions were analyzed as stemming from a difference in whether the peripheral argument was introduced as a PP, as in (13), or an applied object DP, as in (14). Consistent with this view and with the surface *ang*-marking that we see, the goal argument *lamesa* 'table' in (14) patterns like a DP, and not a non-DP, for the purposes of A'-dependency formation (see also Otsuka and Tanaka 2016). Thus, dependencies must now be formed with the linker RC and the pseudocleft, as in (15), and not with the *kung*-RC and focus fronting, as in (16).

(15) NOMINATIVE-SUBJECT GOAL FORMS DEPENDENCIES LIKE A DP

- a. lamesa=ng [ni-lagy-an ng mag-aarál ng lapis]
 table=LK PFV-put-LV GEN student GEN pencil
 'table the student put a pencil on' ✓'put' LV + Goal linker RC
- b. {Ang ma-bábà=ng lamesa/Ano } ang [ni-lagy-an ng mag-aarál ng lapis].
 NOM ADJ-low=LK table what.NOM NOM PFV-put-LV GEN student GEN pencil
 'What the student put a pencil on is the low table.'
 'What did the student put a pencil on?' ✓'put' LV + Goal pseudocleft

(16) NOMINATIVE-SUBJECT GOAL CANNOT FORM DEPENDENCIES LIKE A NON-DP

- a. *lamesa kung {saan /ano } [ni-lagy-an ng mag-aarál ng lapis]
 table if where what PFV-put-LV GEN student GEN pencil
 'table where the student put a pencil' *'put' LV + Goal kung-RC
- b. *{Ang ma-bábà=ng lamesa/Ano } [ni-lagy-an ng mag-aarál ng lapis].
 NOM ADJ-low=LK table what.NOM PFV-put-LV GEN student GEN pencil
 Intended: 'It's the table that the student put a pencil on.'
 Intended: 'What did the student put a pencil on?' *'put' LV + Goal focus fronting

The third type of evidence does not adjudicate on the question of whether the split is sensitive to DP-hood or argument/adjunct status. Rather, it shows that the distinction cannot be between pivots and non-pivots. We see that A'-dependencies of non-pivot DPs, when they are possible, take the same form as those of pivots. Research over the years has revealed that the well-established pivot-only extraction restriction in Tagalog is not exceptionless, and that some non-pivot DPs may also be targeted for A'-dependencies. These are discussed in more detail in Chapter 6. Significant for current purposes is the fact that these dependencies take the form of DP dependencies. For example, genitive arguments of recent perfective clauses (which lack pivots) can be focused and relativized, as shown in (17). Significantly, these A'-dependencies must take the form of pseudoclefts and linker RCs. As shown in (18), focus fronting and *kung*-RCs cannot be used in these genitive-targeted A'-dependencies.

(17) A'-DEPENDENCIES OF NON-PIVOT DPs ARE DP-LIKE

- a. Kaka-kain lang ng bata ng mangga.
 RPFV-eat only GEN child GEN mango
 'The child has just eaten a mango.' Baseline; (Kroeger 1993, p.53)
- b. Sino ang [kaka~kain lang ng mangga]?
 who NOM RPFV-eat only GEN mangga
 'Who has just eaten a/the mango?' Pseudocleft; (Kroeger 1993, p.53)
- c. Gutóm pa ang bata=ng [kaka~kain lang ng mangga].
 hungry still NOM child=LK RPFV-eat only GEN mangga
 'The child who just ate a/the mango is still hungry.' Linker RC

(18) FOCUS FRONTING AND *kung*-RCs CANNOT TARGET NON-PIVOT DPs

a. *{Sino /Nino } [kaka~kain lang ng mangga]?

who.NOM who.GEN RPFV-eat only GEN mangga

Intended: 'Who has just eaten a/the mango?'

*Focus Fronting

b. *Gutóm pa ang bata **kung** {sino /nino } (ang) [kaka~kain lang ng mangga].

hungry still NOM child if who.NOM who.GEN NOM RPFV-eat only GEN mangga

Intended: 'The child who just ate a/the mango is still hungry.'

*Kung-RC

We see, then, that the distribution of linker RCs and pseudoclefts does not overlap with that of *kung*-RCs and focus fronting, with respect to the kinds of clausal dependents that they target. Moreover, we see that the distribution is indeed conditioned on the category of the dependency target and not some other property such as theta-role or pivothood.²

In the next two sections, I discuss in detail the structure of the four A'-dependency constructions previously introduced. I will show that these constructions are structurally distinct from each other, and that the distinct behaviors exhibited are indicative of particular structures for these constructions. This discussion summarizes and builds on previous work, drawing particularly on an established body of work on the difference between focus constructions of DPs and non-DPs (e.g., Richards 1998; Aldridge 2002; Mercado 2004).

4.2 Structural differences between DP and non-DP focus

Recall that the two types of focus constructions can be distinguished by the presence or absence of a determiner *ang* between the focus- or *wh*-constituent and the remainder of the clause, which I will refer to as the presuppositional statement. We see in (19a) that *ang* is obligatory with DP focus, whereas (19b) shows that *ang* is ungrammatical with non-DP focus.

(19) a. {Ang kalabaw /Ano } *(**ang**) nali~ligo sa ilog.

NOM water.buffalo what.NOM NOM AV.IMPF~bathe OBL river

'What is bathing in the river is the water buffalo.'

'The one bathing in the river is what?'

²One question that will be left open in this thesis bears pointing out. As discussed in Section 2.4.3 and noted by previous authors, Tagalog has a behavior resembling differential object marking (DOM), where non-pivot themes are marked oblique (i.e., *sa*) when definite. We can therefore ask whether or not this type of oblique marking affects A'-dependencies targeting themes. The issue turns out to be somewhat complex. As Latrouite (2012) discusses, definite non-pivot themes, and therefore DOM, are mostly impossible in most prototypical declarative clauses (i.e., those not involved in an A'-dependency construction). Thus, for examples like (i), we might not expect any kind of special behavior from the theme to begin with. On the other hand, this definiteness restriction relaxes in certain contexts, consequently allowing DOM. Such contexts include agent pseudoclefts and clauses predicated with certain verbs (as Latrouite notes), as well as gerunds and agent relative clauses, as shown at the end of Sec. 3.4.1 and in Sec. 6.2.3. The behavior of such constructions under (further) A'-dependency formation is complex and heterogeneous, and deserves closer study, which unfortunately cannot be undertaken in this thesis.

(i) Nag-imbata ang guro {ng /*sa } mga mag-aaral
AV.PFV-invite NOM teacher GEN OBL PL student
'The teacher invited {some/*the} students.'

- b. {Sa ilog /Saana } (***ang**) nali~ligo ang kalabaw.
 OBL river where NOM AV.IMPF~bathe NOM water.buffalo
 'It's in the river that the water buffalo is bathing.'
 'Where is the water buffalo bathing?'

This difference in the distribution of *ang* is one of a number of pieces of evidence that point to a structural difference between DP and non-DP focus constructions. Here, I follow one prevailing view of this difference, that DP focus has a pseudocleft structure, while non-DP focus involves more straightforward fronting to a clause-peripheral position (Aldridge 2002; Mercado 2004; Gerassimova and Sells 2008; Potsdam 2009). Put differently, the difference between these two types of constructions lies in the formal relationship between the clause-initial focus constituent and the following presuppositional statement.

The pseudocleft analysis of DP focus constructions like (19a) holds that these formally consist of two DPs in a copular clause structure, as highlighted by the bracketing in (20a). Under this view, the focus constituent in the clause-initial position is a copular clause predicate, here labeled Pred. Consequently, the subject position of this copular clause (labelled Subj) is occupied by the presuppositional statement, which takes the form of a relative clause. A number of details make such an analysis at least plausible. First, since Tagalog is a strongly predicate-initial language without an overt copula (Sec. 2.2)³ the DP_{Pred} is in the expected position for predicates. Second, the nature of DP_{Subj} as a relative clause construction is evident from the fact that it may appear either headless (as we have seen in previous examples), or with an overt nominal head (in this case *hayop* 'animal'). This pseudocleft structure of DP focus can be understood to be periphrastic, especially in comparison to the focus fronting structure of non-DP focus, as exemplified by (19b). The latter type of construction is assumed to be more cross-linguistically typical in that the focused non-DP undergoes A'-movement from a base position to a dedicated focus position in the left periphery. This structure is represented in (20b), where movement is indicated through co-indexing with a trace. These two structures are also represented in more schematic form in (21).

- (20) a. [_{Pred} Ang kalabaw] [_{Subj} ang (hayop na) [_{CP} nali~ligo sa ilog]].
 NOM water.buffalo NOM animal LK AV.IMPF~bathe OBL river
 '[What is bathing in the river] is [the water buffalo].'
 '[The animal that is bathing in the river] is [the water buffalo].' Pseudocleft structure of (19a)
- b. [_{CP} [_{PP} Sa ilog]_i nali~ligo ang kalabaw *t_i*]].
 OBL river AV.IMPF~bathe NOM water.buffalo
 'It's in the river that the water buffalo is bathing.' Focus fronting structure of (19b)
- (21) a. [_{DP/Pred} FOC] [_{DP/Subj} *ang* [_{CP} V ...]] Pseudocleft
 b. [_{CP} [_{PP} FOC]_i [_{IP} V ... *t_i* ...]] Focus Fronting

Converging evidence supporting this difference in structure can be found in a number of areas. Particularly, we find predicate-like behavior with the focus constituent of DP focus but not non-DP focus, and we find subject- and DP-like behavior with the presuppositional statement of DP focus but not non-

³Although see Richards 2009b for some more detailed discussion on the copula in Tagalog.

DP focus. As an aid to the reader, I provide English free translations for these focus constructions that highlight the structural distinctions argued for.

4.2.1 The particle *ang*: Subjecthood of presuppositional statement

The main difference we have seen so far between pseudoclefts and focus fronting in Tagalog is the presence or absence of the particle *ang* between the focus phrase and the presuppositional statement, as was shown in (19).

Assuming that the intermediary (second) *ang* in (19a) is the regular determiner *ang* that marks DPs in Tagalog is consistent with the pseudocleft analysis of DP focus constructions. In particular, nominative marking on the presuppositional statement of the pseudocleft is expected, as this is the marking normally found on subjects of copular clauses (Richards 1998; Aldridge 2002; Mercado 2004). Furthermore, the nominative-marked presuppositional statement is identical in form to a headless relative clause, and can serve as a DP in other contexts, but importantly in argument positions, as shown in (22). Compare this to the structure assumed for pseudoclefts, as schematized in (23).

(22) HEADLESS RELATIVE CLAUSES IN ARGUMENT POSITIONS

- a. Ma-bait [ang nali~ligo sa ilog].
 ADJ-kind NOM AV.IMPF~bathe OBL river
 '[The one that is bathing in the river] is gentle/docile.'
- b. K<um>a~kain ng bulaklak [ang nali~ligo sa ilog].
 AV.IMPF~eat GEN flower ADJ-kind NOM AV.IMPF~bathe OBL river
 '[The one that is bathing in the river] eats flowers.'
- c. T<in>awag ng magsasaká [ang nali~ligo sa ilog].
 <PFV>call[PV] GEN farmer NOM AV.IMPF~bathe OBL river
 'The farmer called (out to) [the one that is bathing in the river].'

(23) PSEUDOCLEFT STRUCTURE FOR DP FOCUS CONSTRUCTIONS

- [Pred Ang kalabaw] [Subj ang nali~ligo sa ilog].
 NOM water.buffalo NOM AV.IMPF~bathe OBL river
 '[Subj What is bathing in the river] [Pred is the water buffalo].'

This treatment of the intermediary *ang* in pseudoclefts as a determiner contrasts with a potential alternative view: that it is a dedicated focus/inversion particle that just happens to be homophonous with the nominative determiner *ang*. Tagalog does have at least one (other) such particle *ay*, that is clearly specific to fronting (or inversion) constructions.⁴ In *ay*-inversion constructions, the fronted phrase is interpreted as old information (topic) and the particle *ay* appears immediately after (see also Schachter and Otanes 1972, §7.2, Kroeger 1993). Thus, pairs like (24) are possible.

⁴Related languages also make use of dedicated particles for focus constructions that are not homophonous to determiners. For example, in Malagasy, the focus particle *no* contrasts with the determiner *ny* (Paul 2001).

(24) DIFFERENT “FRONTING PARTICLES”

- a. Ang kalabaw **ang** nali~ligo sa ilog.
 NOM water.buffalo NOM AV.IMPF~bathe OBL river
 ‘What’s bathing in the river is the water buffalo.’
- b. Ang kalabaw **ay** nali~ligo sa ilog.
 NOM water.buffalo TOP AV.IMPF~bathe OBL river
 ‘As for the water buffalo, it is bathing in the river.’

Ay is amenable to an inversion or topicalization particle analysis because it only appears in this topicalization construction. Furthermore, in this construction, no other particle may be used. In contrast, the intermediary *ang* in (23) may take on different forms. This behavior is clearest in *wh*-questions, where the pseudocleft subject may be marked with the full range of determiners that can appear on a nominative DP in argument position.⁵

In DP arguments, the determiner *ang* can be replaced by a number of other determiner-like elements. As (25) shows, alternatives include the referential determiner *yung*,⁶ and the full series of nominative demonstratives (*ito*, *iyang*, *iyon*) with the linker morpheme.

- (25) Nali~ligo {**ang /yung/ito=ng** /**iyang=g** /**iyon=g** } kalabaw
 AV.IMPF~bathe NOM NOM PROX(NOM)=LK MED(NOM)=LK DIST(NOM)=LK water.buffalo
 ‘{The/This/That} water buffalo is bathing.’ Argument DP

We find the same behavior in *wh*-questions: the subject of a *wh*-question (i.e., the presuppositional statement) may be marked with the same range of elements, as shown in (26). Furthermore, there is no clear semantic effect of using an alternative element that we would not independently expect from the semantics of that element (e.g., deixis). That is, there is no strong evidence that the construction with *ang* is fundamentally different from the construction with *yung* and others.

- (26) Ano {**ang /yung/ito=ng** /**iyang=g** /**iyon=g** } nali~ligo sa ilog?
 what(NOM) NOM NOM PROX(NOM)=LK MED(NOM)=LK DIST(NOM)=LK AV.IMPF~bathe OBL river
 ‘What’s bathing in the river?’
 lit.: ‘{The/This/That} one bathing in the river is what?’ Pseudocleft Subject

⁵The picture is slightly more complicated with non-*wh* pseudoclefts, where the only valid alternative to the intermediary *ang* is *yung*. Interestingly, *yung* cannot mark the subject when the predicate is marked with *ang*.

(i) {Yung/*Ang} kalabaw **yung** nali~ligo sa ilog.
 NOM NOM water.buffalo NOM AV.IMPF~bathe OBL river
 ‘What’s bathing in the river is the water buffalo.’

This restriction appears to be tied to a general restriction on word order in DP-DP copular clauses such that the more “referential” (loosely speaking) DP must precede the less referential one. For example, proper names and pronouns must precede common nouns, as in (ii); see Or 2015, ex.16 for further discussion and references. Thus, since *yung* is more referential than *ang* (Nagaya 2011), the restriction in (i) is expected.

(ii) a. {Ako /Si Henrison} [ang awtor ng thesis]. b. *[Ang awtor ng thesis] {ako /si Henrison}.
 1SG.NOM NOM Henrison NOM author GEN thesis NOM author GEN thesis 1SG.NOM NOM Henrison
 ‘{I am/Henrison is} the author of the thesis.’ Intended: ‘{I am/Henrison is} the author of the thesis.’

⁶This determiner is transparently related to the distal demonstrative marked with the linker: *iyong*, having undergone some degree of grammaticalization to become closer to a general determiner, especially in more colloquial registers. See Nagaya (2011) for further discussion.

This behavior makes it hard to maintain the view that the intermediary *ang* in pseudoclefts is a dedicated focus particle that simply happens to be homophonous with the nominative determiner. Such a view would require assuming that all the possible alternative particles shown in (26) are also distinct but homophonous from their respective determiner counterparts. It is more parsimonious to instead assume that these are simply determiners, even when they appear in pseudoclefts. Thus, we see that intermediary *ang* in DP focus constructions indicates that the presuppositional statement is itself a DP, in line with the idea that these focus constructions have a pseudocleft structure.

Conversely then, we also have strong evidence that non-DP focus does *not* have the same pseudocleft structure of DP focus. The lack of *ang* (or any overt determiner, for that matter) is strong evidence that the presuppositional statement of non-DP focus is *not* a DP, and is therefore not the (DP) subject of a pseudocleft.

4.2.2 Predicatehood of focus constituent

We have just seen that with DP focus, the particle marking the presuppositional statement shows the distribution of a determiner, suggesting a DP structure. This conclusion is consistent with a pseudocleft analysis, which assumes that the presuppositional statement appears as a (headless) relative clause in subject position. Complementing this observation, it has also been argued in previous work (recent works include Mercado 2004; Or 2015) that the *focus constituents* of DP focus constructions show properties consistent with predicatehood, while non-DP focus constituents do not. In particular, we will see that DPs readily function as predicates in other constructions, while the behavior of non-DPs in this regard is less consistent.

Outside of clear focus constructions, DPs may serve as clausal predicates, as we see with the examples in (27). These examples each contain two juxtaposed DPs (enclosed in square brackets) that are only distinguished by word order. That is, nothing else marks one of the DPs as clearly predicative. In DP focus constructions, we see that the focus constituents take the same form as regular DP predicates; compare (27) and (28).

(27) DPs CAN SERVE AS PREDICATES

- a. {Si John Lloyd Cruz/Ang kapatid mo } [ang bida ng pelikula=ng ito].
NOM.P John Lloyd Cruz NOM sibling 2SG.GEN NOM protagonist GEN movie=LK PROX
 'The protagonist of this movie is {John Lloyd Cruz/your sibling}.'
- b. [Si Simoun] [si Crisostomo Ibarra].
NOM.P Simoun NOM.P Crisostomo Ibarra
 'Crisostomo Ibarra is Simoun.'

(28) DP FOCUS CONSTRUCTIONS (*cf.* 27)

- a. {Si John Lloyd Cruz/Ang kapatid mo } [ang na-kita ko sa paliparan].
NOM.P John Lloyd Cruz NOM sibling 2SG.GEN NOM NVOL.PFV-see[PV] 1SG.GEN OBL airport
 'The one I saw at the airport was {John Lloyd Cruz/your sibling}.'

- b. [Si Simoun] [ang u~upo dito].
 NOM.P Simoun NOM FUT~sit(AV) OBL.PROX
 'The one who will sit here is Simoun.'

We turn now to non-DP predicates, paying particular attention to oblique-marked phrases. While we have seen that these phrases can convey locative meanings as adjuncts, as with *sa sofa* in (29a), they *cannot* be used predicatively to convey the same information, as (29b) shows. To serve as a locative predicate, the oblique phrase must bear an invariant prefix *na-*, as in (29c) (recall Sec. 2.4.2.1).

(29) LOCATIVE OBLIQUE PREDICATES REQUIRE *na-*

- a. Natu~tulog si Ricky **sa sofa**.
 AV.IMPF~sleep NOM.P Ricky OBL couch
 'Ricky is sleeping on the couch.'
- b. ***Sa sofa** si Ricky.
 OBL couch NOM.P Ricky
 Intended: 'Ricky is on the couch.'⁷
- c. **Na-sa sofa** si Ricky.
 PRED-OBL couch NOM.P Ricky
 'Ricky is on the couch.'

In certain situations, bare obliques are possible as clausal predicates, but they convey a restricted set of meanings. The minimal pair in (30) shows a clear example of this. With the bare oblique predicate in (30a), the assertion is that Sophia is the owner of the hat. On the other hand, the *na*-marked oblique predicate in (30b) conveys that the hat is in Sophia's possession, making no assertion about ownership.⁸

(30) MEANING DIFFERENCES IN OBLIQUE PREDICATES

- a. **Kay Sophia** ang pula=ng sumbrero.
 OBL.P Sophia NOM red=LK hat
 'The red hat is Sophia's.'
- b. **Na-kay Sophia** ang pula=ng sumbrero.
 PRED-OBL.P Sophia NOM red=LK hat
 'The red hat is {with Sophia/in Sophia's possession}.'

Comparing oblique predicates with oblique focus reveals that they are quite distinct from each other. First, as Mercado (2004) points out, the predicative (*na*-marked) oblique form is ungrammatical in focus constructions, as shown in (31). Second, unlike what we saw with bare oblique predicates (30), we do not find general restrictions on the interpretation of the non-DP focus; the meaning of the non-DP focus is predictable from the corresponding non-focus sentence. For example, non-pivot causees, which are marked OBL, can be focused, as shown in (32).

⁷A potentially available reading in this case is something like 'Ricky is to go on the couch', implying some sort of motion.

⁸Mercado (2004, fn.7) notes that bare oblique predicates can also be used to convey directional meanings; see also fn.7 above.

(31) OBLIQUE FOCUS UNGRAMMATICAL WITH PREDICATIVE FORM (cf. 29)

a. **Sa sofa** natu~tulog si Ricky.

OBL couch AV.IMPF~sleep NOM.P Ricky

'It's on the couch that Ricky is sleeping.'

b. ***Na-sa sofa** natu~tulog si Ricky.

PRED-OBL couch AV.IMPF~sleep NOM.P Ricky

Intended: 'It's on the couch that Ricky is sleeping.'

(32) OBLIQUE FOCUS PHRASE HAS THE ROLE ASSOCIATED WITH ITS BASE POSITION (cf. 30)

a. I-pa~pa-ayos ng laláki **kay Sophia** ang pantalon niya.

CV-FUT~CAUS-fix GEN man OBL.P Sophia NOM pants 3SG.GEN

'The man will {have/make} Sophia fix his pants.'

b. **Kay Sophia** i-pa~pa-ayos ng laláki ang pantalon niya.

OBL.P Sophia CV-FUT~CAUS-fix GEN man NOM pants 3SG.GEN

'It's Sophia that the man will {have/make} fix his pants.'

Mercado further provides corroborating evidence for the different predicatehood behaviors discussed so far from *ay*-inversion, previously mentioned at the beginning of this subsection. In non-verbally predicated clauses, the subject can undergo *ay*-inversion as (33) shows.

(33) *Ay*-INVERSION IN NON-VERBALLY PREDICATED CLAUSES

a. Ma-tangkad at ma-lusog na bata [ang babae=ng iyon] .

ADJ-tall and ADJ-healthy LK child NOM female=LK DIST

'[That girl] is a tall and healthy child.'

Baseline

b. [Ang babae=ng iyon] ay ma-tangkad at ma-lusog na bata.

NOM female=LK DIST TOP ADJ-tall and ADJ-healthy LK child

'[That girl] is a tall and healthy child.' *Ay*-inversion (Mercado 2004, ex.16, glosses modified)

Parallel to this behavior exhibited by non-verbally predicated clauses, *ay*-inversion can apply to the presuppositional statement of a DP focus construction, but not to that of a non-DP focus construction, as the contrast in (35) shows (presuppositional statements bracketed).

(34) BASELINE FOCUS CONSTRUCTIONS

a. Si Simoun [ang u~upo dito].

NOM.P Simoun NOM FUT~sit(AV) OBL.PROX

'The one who will sit here is Simoun.'

DP focus, repeated from (28b)

b. Sa sofa [natu~tulog si Ricky].

OBL couch AV.IMPF~sleep NOM.P Ricky

'It's on the couch that Ricky is sleeping.'

Non-DP focus, repeated from (31a)

(35) *Ay*-INVERSION OF PRESUPPOSITIONAL STATEMENTS

- a. [Ang u~upo dito] ay si Simoun.
 NOM FUT~sit(AV) OBL.PROX TOP NOM.P Simoun

'The one who will sit here is Simoun.' (cf. 34a)

- b. *[Natu~tulog si Ricky] ay sa sofa.
 NOM.P Ricky TOP OBL couch AV.IMPf~sleep

Intended: 'It's on the couch that Ricky is sleeping.' (cf. 34b)

Note further that the two kinds of oblique predicates discussed, marked with *na-* and otherwise, pattern with other non-verbally predicated clauses, as shown in (36) shows. This again shows us that the oblique (i.e., non-DP) focus constituent behaves differently from oblique predicates generally.

(36) *Ay*-INVERSION WITH OBLIQUE-MARKED PREDICATES

- [Ang pula=ng sumbrero] ay (na-)kay Sophia.
 NOM red=LK hat TOP PRED-OBL.P Sophia

'The red hat is Sophia's.' (cf. 30)

We have thus seen evidence that DPs can independently be clausal predicates, and that DP focus constituents behave in the same way as these predicates. This evidence supports the pseudocleft analysis of DP focus constructions. In contrast, non-DPs require extra morphology to serve as predicates, or otherwise have restricted possibilities for interpretation. Comparing these non-DP predicates to the corresponding non-DP focus constituents shows fairly distinct behavior, suggesting that a pseudocleft analysis is *not* appropriate for non-DP focus, and therefore that the two types of focus constructions are structurally distinct.⁹

⁹It is also worth noting here that negation has been argued to diagnose predicatehood in Tagalog. For example, in DP focus constructions, the negator *hindi* can appear immediately before the first *ang*-marked DP as in (i), despite not being possible on *ang*-marked DPs in clearly non-predicate positions as in (ii). Furthermore, (iii) shows that the presupposition of a DP focus construction patterns like other non-predicate DPs in that negation may not appear immediately before it.

(i) [Hindi ang guro] [ang magba~basa ng artikulo].
 NEG NOM teacher NOM AV.FUT~read GEN article
 'The one who will read the article] is [not the teacher].'

(ii) [Hindi ma-tangkad] [(*hindi) ang bata=ng iyon].
 NEG ADJ-tall NOM child=LK DIST
 'That child] is [not tall].'

(iii) [Ang guro] [(*hindi) ang {hindi} magba~basa ng artikulo].
 NOM teacher NOM NEG AV.FUT~read GEN article
 'The one who will not read the article] is [the teacher].'

Perhaps problematically, negation can also mark the non-DP focus constituent, as (iv) shows. This would suggest that this focus constituent is in fact a predicate, contrary to what I have argued thus far. Interestingly, we also see in (iv) that it is possible to negate the presuppositional statement.

(iv) [{Hindi} sa Tuguegarao] [{hindi} p<um>unta ang mga pinsan ko].
 NEG OBL Tuguegarao NEG <AV>go(PFV) NOM PL cousin 1SG.GEN
 'It's [not to Tuguegarao] that [my cousins went].' (Pre-focus NEG)
 'It's [to Tuguegarao] that [my cousins did not go].' (Pre-presupposition NEG)

One possible approach to reconciling this data with the other predicatehood diagnostics discussed above might be to say that the non-DP focus constituent is a predicate whose "subject" loosely speaking is verbal or clausal, instead of a DP as with pseudoclefts. This would put non-DP focus constructions into the same general class as constructions like control and tough-movement-like constructions, which have different structures from clauses with DP subjects. Examples are given in (v). I leave investigation of this for future work.

4.2.3 Clitic placement

The clitic particles in Tagalog (see Section 2.2) also help us distinguish between the two types of focus constructions. As previously mentioned, these clitics appear after the first constituent relative to some domain, to a first approximation (e.g., IP for Kroeger (1993), see also Kaufman 2010 for more detailed discussion). This class of particles includes personal pronouns, discourse particles, and a number of adverbs. In an information-structurally neutral verb-initial sentence, these clitics appear following the verb, as shown in (37).

(37) CLITIC PLACEMENT IN A V-INITIAL SENTENCE

Umi~inom **daw kasi siya** ng kape araw-araw.
 AV.IMPF~drink QUOT because 3SG.NOM GEN coffee everyday
 'It's reportedly because they_{SG} drink coffee everyday.'

On the other hand, clitics obligatorily attach to the first of any pre-verbal clausemate elements if present. In such a case, encliticization on the verb is ungrammatical. An example is shown in (38), featuring negation, which is pre-verbal. The curly braces in this and all following examples show various slots for the second position clitics. The presence or absence of the star in the braces marks ungrammaticality (or otherwise) of the material contained in the braces appearing *in that position*. Thus, (38) shows that the clitic string *daw kasi siya* is grammatical immediately following the negation *hindi*, but *ungrammatical* following the verb *umiinom*.

(38) CLITIC PLACEMENT IN A NEGATED SENTENCE

Hindi {**daw kasi siya**} umi~inom {***daw kasi siya**} ng kape araw-araw.
 NEG QUOT because 3SG.NOM AV.IMPF~drink GEN coffee everyday
 'It's reportedly because they_{SG} don't drink coffee everyday.'

The domain of clitic placement is clause-bound. For example, (39) shows that the placement of the pronoun *ko* is determined with respect to the relative clause that it originates from.

(39) CLITICS ORIGINATING FROM AN EMBEDDED CLAUSE

- a. Tuma~takbo {***ko**} ang babae=ng [k<in>a-usap {**ko**} kanina].
 AV.IMPF~run 1SG.GEN NOM woman=LK <PFV>COM-talk(PV) 1SG.GEN earlier
 'The woman [who I spoke to earlier] is running.'
- b. Tuma~takbo {***ko**} ang babae=ng [hindi {**ko**} k<in>a-usap kanina].
 AV.IMPF~run 1SG.GEN NOM woman=LK NEG 1SG.GEN <PFV>COM-talk(PV) earlier
 'The woman [who I didn't speak to earlier] is running.'

Previous work has pointed out that the two kinds of focus constructions exhibit different patterns with respect to clitic placement (Richards 1998; Aldridge 2002). The relevant data is provided in (40).

(v) {Gusto niya=ng /Ma-hirap } mag-sulat ng thesis.
 want 3SG.GEN=LK ADJ-difficult AV-write GEN thesis
 'They_{SG} want/It is difficult to write a thesis.'

With focus fronting (40a), clitics must follow the fronted constituent. This behavior is parallel to what we saw in (38) with sentential negation, suggesting that the focus phrase appears in the same domain as the clitic pronouns in the presuppositional statement.¹⁰ In a pseudocleft (40b), on the other hand, clitics must follow the (embedded) verb. This behavior is parallel to what we saw in (39) with relative clauses, suggesting that the focus phrase in this case appears outside the domain of the clitic pronouns in the presuppositional statement. (41) presents the different clitic placement positions schematically.

(40) DIFFERENT CLITIC PLACEMENT FOR DP AND NON-DP FOCUS CONSTRUCTIONS

a. Kay Inday {**ko**} i-b<in>igay {***ko**} ang pusa=ng ito.
 OBL Inday 1SG.GEN CV-PFVgive 1SG.GEN NOM cat=LK this
 'It was to Inday that I gave this cat.' Focus Fronting (Non-DP Focus)

b. Ang pusa=ng ito {***ko**} ang i-b<in>igay {**ko**} kay Inday.
 NOM cat=LK this 1SG.GEN NOM CV-PFVgive 1SG.GEN OBL Inday
 'What I gave to Inday was this cat.' Pseudocleft (DP Focus)

(41) a. [CP [PP FOC]_i [=CL] [IP V ... t_i ...]] Focus Fronting

b. [DP/Pred FOC] [DP/Subj ang [CP V [=CL] ...]] Pseudocleft

As with the behavior surrounding *ang*, the clitic placement evidence supports the view that DP focus constructions are indeed pseudoclefts. If the presuppositional statement in these constructions is indeed a headless relative clause, then the lower encliticization position falls out from independently established facts about clitic placement and relative clauses.

4.2.4 *Siyang*

In certain contexts, we see the appearance of an expression *siyang*, which Schachter and Otnes (1972, §3.24) describe indicating explicit contrast. Richards (1991) discusses the distribution of this expression and shows that it may appear immediately before the lexical predicate of a relative clause, but not before a main clause predicate.

(42) DISTRIBUTION OF *siyang* (Richards 1991, exx.17–18)

a. K<um>ain ako ng isda=ng [**siya=ng** ini-handa ng sikát na tagapagluto].
 <AV>eat(PFV) 1SG.NOM GEN fish=LK *siya*=LK CV.PFV-prepare GEN famous LK cook
 'I ate the *very* fish that was prepared by the famous cook.' Relative Clause

b. ***Siya=ng** ini-handa ang isda ng sikát na tagapagluto.
siya=LK CV.PFV-prepare NOM fish GEN famous LK cook
 Intended: 'The fish is the *very* thing that was prepared by the famous cook.' Main Clause

¹⁰In fact, the focus fronting example can be further negated, causing encliticization to the negation particle.

(i) Hindi {**ko**} kay Inday {***ko**} i-b<in>igay {***ko**} ang pusa=ng ito.
 NEG 1SG.GEN OBL Inday CV-PFVgive NOM cat=LK this
 'It wasn't to Inday that I gave this cat.'

cf. (40a)

Some naturally occurring examples of *siyang* support this generalization. Clear examples of *siyang* marking relative clauses like (43) are easily found using search engines. On the other hand, no clear example of *siyang* marking a main clause was found where *siyang* co-occurred with an overt pivot in the same clause.

(43) EXAMPLES ATTESTED ON THE INTERNET OF *siyang* IN RCs

- a. Ito rin ang simula ng sumpa na [siya=ng puno='t dulo ng kuwento].
 NOM.PROX also NOM start GEN curse LK *siya*=LK source=and end GEN story
 'This is also the start of the curse [that is the beginning and end of the story].' Web¹¹
- b. Ang nati~tirá=ng pera naman ay i-b<in>ili namin ng mga equipment
 NOM NVOL.IMPF~remain=LK money *naman* TOP CV-<PFV>buy IPL.EXCL.GEN GEN PL equipment
 na [siya=ng ga~gámit-in para dito].
 LK *siya*=LK FUT~use-PV for OBL.PROX
 'As for the remaining money, we used it to buy equipment that will be used for this [purpose].' Web¹²

While Schachter and Otones describe *siyang* in the context of focus constructions, Richards points out that this marker only appears in a subset of such constructions, specifically those that target DPs, as shown in (44). Here again, we see that pseudoclefts—specifically their subjects—pattern with (DP) relative clauses elsewhere in the language, while focus fronting patterns with monoclausal constructions.

(44) *Siyang* IN FOCUS CONSTRUCTIONS

- a. {Ikaw /Ang mga libro} [ang **siya=ng** na-kita niya].
 2SG.NOM NOM PL book NOM *siya*=LK NVOL.PFV-see(PV) 3SG.GEN
 'It's {you/the books} that she saw.' Pseudocleft
 (Schachter and Otones 1972, p.152)
- b. *Sa sala **siya=ng** na-kita ni Julian ang mga libro.
 OBL living.room *siya*=LK NVOL.PFV-see(PV) GEN Julian NOM PL book
 Intended: 'It was in the living room that Julian saw the books.' *Focus Fronting

It is worth noting that Schachter and Otones (1972, p.152) argue that while this contrast-marking *siya=ng* is homophonous with the third person singular nominative pronoun with an attached linker, they are not the same element. As evidence, they provide (44a), showing that *siyang* does not agree in ϕ -features with the focused phrase, even if they are non-third-person or non-singular.

4.2.5 Weak crossover patterns

One final diagnostic of the different structure between the two focus constructions comes from weak crossover effects. This diagnostic turns out to be less conclusive than others, but the contrast is neverthe-

¹¹"Death scene ni Maja Salvador sa 'The Killer Bride', nag-trending," *ABS-CBN News*, August 15, 2019, <https://news.abs-cbn.com/entertainment/08/15/19/death-scene-ni-maja-salvador-sa-the-killer-bride-nag-trending>.

¹²Philippine Information Agency, "Balisong Academy, sisimulan sa Setyembre," news release, September 20, 2020 1:44pm -04:002019-08-13, <https://pia.gov.ph/news/articles/1025792>.

less worth pointing out. Richards (1991) observes that weak crossover effects surface with focus fronting, but not with pseudoclefts. Both sentences in (45) involve extraction of a recipient argument that apparently crosses over a co-indexed pronominal possessor in an agent position. However, we only observe a crossover violation when the extracted constituent is a non-DP. For comparison, the corresponding base-line declarative sentences both allow co-reference between the recipient and the possessor of the agent.

(45) WEAK CROSSOVER IN *wh*-QUESTIONS

- a. **Kanino**_x i-b<in>igay ng **kanya**_{*x/y}=ng ama ang pera?
 who.OBL CV-<PFV>give GEN 3SG.OBL=LK father NOM money
 'Who_x did their_{SG{*x/y}} father give the money to?' Focus fronting → WCO
- b. **Sino**_x ang b<in>igy-an ng **kanya**_{x/y}=ng ama ng pera?
 who.NOM NOM <PFV>give-LV GEN 3SG.OBL=LK father GEN money
 'Who_x did their_{SG{x/y}} father give the money to?'
 lit: 'The one who their_{SG{x/y}} father give the money to is who_x?' Pseudocleft → No WCO

(46) CO-INDEXING POSSIBLE IN NON-FOCUS SENTENCES

- a. I-b<in>igay kay **Gina**_x ng **kanya**_{x/y}=ng ama ang pera.
 CV-<PFV>give OBL.P Gina GEN 3SG.OBL=LK father NOM money
 'The money was given to Gina_x by her_{x/y} father.'
- b. B<in>igy-an si **Gina**_x ng **kanya**_{x/y}=ng ama ng pera.
 <PFV>give-LV NOM.P Gina GEN 3SG.OBL=LK father GEN money
 'Gina_x was given money by her_{x/y} father.'

Between the two examples in (45), the behavior we see in (45a) is perhaps more expected. Assuming that the oblique goal is c-commanded by the agent containing the co-indexed pronoun, and that focus fronting results from A'-movement to a clause peripheral position, then we have the correct configuration for weak crossover. On the other hand, interpreting the absence of the weak crossover effect in (45b) is perhaps slightly more subtle, because the gap in this case corresponds to the nominative pivot.

Independent of the analysis of Tagalog DP A'-dependencies to be proposed in Chapter 5, we might reasonably assume that the formation of (45b) involves A'-movement from some lower position of the focus/*wh*-constituent or of a null operator, following a headless relative clause analysis of the presuppositional statement. Data like (45b) thus suggests that the focus constituent (in this case *sino* 'who.NOM') or null operator does not undergo A'-movement from a base position that the agent c-commands, such as a thematic goal position. Otherwise, we would incorrectly predict no difference in behavior between pseudoclefts and focus fronting with respect to weak crossover effects.

However, this result does not rule out A'-movement from a higher position, which is a possible analysis, since the dependency target in (45b) is the clausal pivot. In particular, scholars have argued that the nominative pivot of a Tagalog clause is syntactically high, at least in a position c-commanding the agent (see e.g., Nakamura 1996; Rackowski and Richards 2005; Kaufman 2009; Erlewine et al. 2015 for various implementations of this idea). Assuming that a goal pivot comes to occupy this high position by some

mechanism other than A'-movement (i.e., base generation or A-movement), subsequent A'-movement of the focus constituent or null operator would not occur across the co-indexed pronoun, predicting no weak crossover. The upshot of this is that while the weak crossover asymmetry discussed here is consistent with the pseudocleft analysis of DP focus constructions, it does not definitively rule out the alternative view that both kinds of A'-dependencies are formed through similar mechanisms and are structurally parallel.

Table 4.2 summarizes the diagnostics presented in this section.

Table 4.2: Structural diagnostics for focus constructions

	FOCUS FRONTING	PSEUDOCLEFT
<i>Ang</i>	Ungrammatical	Obligatory ↔ Marks pseudocleft subject
Predicatehood	Obliques require <i>na-</i> No <i>ay-</i> inversion	DP-DP generalizes beyond focus constructions <i>Ay-</i> inversion possible ↔ Focus phrase is a predicate
Clitic placement domain	Includes focus phrase	Presuppositional statement only ↔ Presup. statement is a relative clause
<i>Siyang</i>	Ungrammatical	Grammatical in presup. statement ↔ Parallel to relative clauses
Weak crossover	WCO	No WCO ↔ No crossover-inducing movement

4.3 Structural differences between DP and non-DP relative clauses

In comparison to the focus constructions, the differences between DP and non-DP relatives have been less well-studied. While the structure of linker RCs has received some attention in the literature (notably Aldridge 2003a, 2004b, 2017a; Law 2016), comparatively little has been said about *kung*-RCs. A recent analysis of *kung*-RCs is from Otsuka and Tanaka (2016) who propose a unified account of linker RCs and *kung*-RCs (oblique relative clauses under their terminology). Under this account, the two kinds of relative clauses are in fact structurally identical, and the surface-observable differences between the two types of relative clauses are a result of the particular lexical inventory of Tagalog, specifically how certain functional heads like C^0 and D^0 are spelled out. I show here, however, that this account cannot be correct. The differences we observe between the two kinds of relative clauses cannot be accounted for purely lexically.

4.3.1 Otsuka & Tanaka (2016)

A summary of Otsuka and Tanaka's (2016) analysis is represented by the tree in (48). Following Bhatt's (2002) head-raising analysis of relative clauses, RC heads are assumed to be base-generated within the relative clause modifier, inside a DP whose head bears an $[OP]$ feature (DP_j). This DP first moves to a clause-peripheral position; this is indicated as movement (A) in (48). To account for the *kung-wh* word

order, Otsuka and Tanaka propose, following Rizzi (1997), that the landing site of this movement is the specifier of an intermediate projection between CP and IP, labeled FP. Following the first movement, the NP dominated by the moved DP undergoes further movement (indicated as (B)), merging with the CP. Crucially, it is the moved NP that projects, and not the CP (see Bhatt 2002, §7.4 for discussion).

The Otsuka and Tanaka analysis also follows the head raising analysis in treating relative pronouns as the spell-out of the D⁰ of the remnant DP. Thus, *saan* is the spell-out of a D⁰ bearing both of the features [OP] (by assumption) and [OBL] (as the relativized position is oblique-marked). Finally, *kung* is argued to be the spell-out of C⁰, specifically one bearing the feature [OBL]. This feature is copied to C⁰ via Agree with the DP in Spec-FP.

- (47) ang lawa kung saan lumangoy ang mangingisdâ
 NOM lake if where <AV>swim(PFV) NOM fisherman
 'the lake where the fisherman swam'

(48) ANALYSIS OF *kung*-RCs FROM OTSUKA AND TANAKA 2016 (SUMMARIZED)

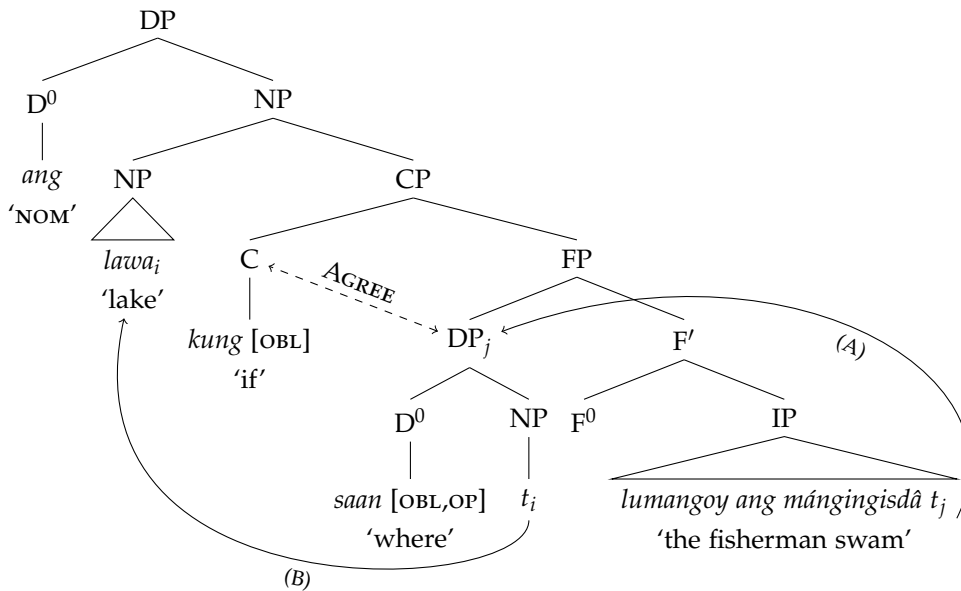

The proposal for the mutually exclusive distribution of linker- and *kung*-RCs is fairly straightforward given the analysis just summarized. An example is provided in (49), with the corresponding tree in (50). Given that linker RCs target nominative positions (focused or [FOC] under their terminology), Otsuka and Tanaka assume that the relevant D⁰ in this case bears [NOM] instead of [OBL]. This difference in feature specification leads to a difference in spell-out for both D⁰ and C⁰. D⁰ bearing [NOM] and [OP] is spelled-out as a null relative pronoun, while C⁰ bearing [NOM] is spelled-out as the linker *na/=ng*.¹³ In other words, the two types of RCs are proposed to be structurally identical, ultimately only differing in the feature specification on the relative pronoun; compare the trees in (48) and (50).

¹³Otsuka and Tanaka (2016) also propose that Tagalog lacks a spell-out for D⁰ bearing genitive (non-focus/[NFOC] for them) and [OP], thus deriving the pivot-only restriction for linker RCs.

- (49) ang mángingisdâ=ng l<um>angoy sa lawa
 NOM fisherman=LK <AV>swim(PFV) OBL lake
 'the fisherman who swam in the lake'

- (50) LINKER RCs ARE STRUCTURALLY IDENTICAL TO *kung*-RCs (OTSUKA AND TANAKA 2016)

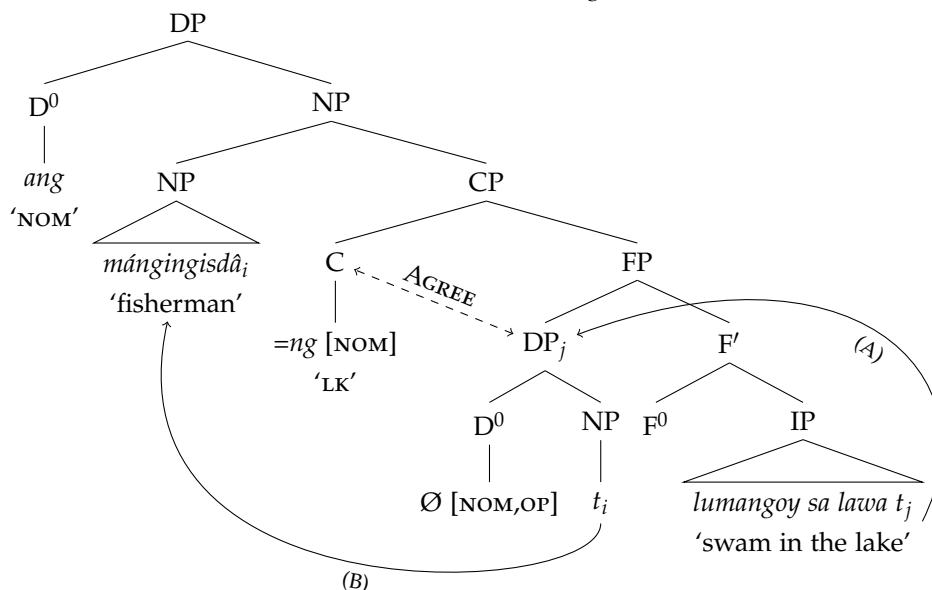

There are, however, reasons to not adopt totally parallel structures for *kung*-RCs and linker RCs. We will see in the remainder of this section that the relative clause head of these two constructions behave in different ways, with that of the linker RC being more flexible in particular ways. Such differences are difficult to reconcile if we assume, as Otsuka and Tanaka do, that the difference between the two relative clause constructions is primarily morphological.

4.3.2 Word-order differences

First, we consider the relative word order of the head and modifier of the relative clause. While the relative clauses considered so far have been ones where the head precedes the modifier, we will see that linker RCs in fact exhibit a number of other possible word orders. In contrast, only the head-initial word order is possible for the *kung*-RC. This difference is unexpected if both constructions share an underlying structure.

It has been observed that various positions are possible for the nominal head in linker RCs: head-initial, head-final, and head-internal (Aldridge 2004b, 2017a; Law 2015).¹⁴ These orders are shown in (51). Note that the position of the linker also changes with the position of the head nominal.¹⁵

- (51) POSSIBLE HEAD-MODIFIER ORDERS FOR LINKER RCs

¹⁴Headless relative clauses are discussed below.

¹⁵Although see Aldridge 2017a for an analysis that does not require positing variable structural positions for the linker.

- a. Ma-tamís ang **ké^{ndi}=ng** b<in>ilí ng bátà.
ADJ-sweet NOM candy=LK <PFV>buy[PV] GEN child
'The candy that the child bought is sweet.' Head-initial Linker RC
- b. Ma-tamís ang b<in>ilí ng bátà=**ng ké^{ndi}**.
ADJ-sweet NOM <PFV>buy[PV] GEN child=LK candy
'The candy that the child bought is sweet.' Head-final Linker RC
- c. Ma-tamís ang b<in>ilí=**ng ké^{ndi}** ng bátà.
ADJ-sweet NOM <PFV>buy[PV]=LK candy GEN child
'The candy that the child bought is sweet.' Head-internal Linker RC

In comparison to what we see with linker RCs, the word order possibilities for *kung*-RCs are much more limited. In fact, *kung*-RCs can only be head-initial, an example of which is provided in (52).

- (52) Ma-lápit lang ang **tindáhan kung saán** b<in>ilí ng bátà ang ké^{ndi}.
ADJ-near only NOM store if where <PFV>buy[PV] GEN child NOM candy
'The store where the child bought the candy is nearby.' Head-initial *Kung*-RC

The head-final and head-internal word orders, however, appear to be impossible for *kung*-RCs. Showing this definitively is not totally straightforward, as it is unclear where *kung* and the *wh*-expression would surface. Using Otsuka and Tanaka's (2016) unified analysis of relative clauses, we can at least attempt to construct examples parallel to the linker RC cases.¹⁶ Below are a number of ungrammatical attempts at producing *kung*-RCs with the different word orders attested for linker RCs. The relative clause head is underlined as an aid for the reader. The examples in (53) show attempts at head-final *kung*-RCs derived using the structure in (48) but varying the linear order of constituents.

- (53) ILL-FORMED HEAD-FINAL *kung*-RCs
- a. *Ma-lápit lang ang **kung saán** b<in>ilí ng bátà ang ké^{ndi} tindáhan.
ADJ-near only NOM if where <PFV>buy[PV] GEN child NOM candy store (CP ≫ NP)
- b. *Ma-lápit lang ang **saán** b<in>ilí ng bátà ang ké^{ndi} kung tindáhan.
ADJ-near only NOM where <PFV>buy[PV] GEN child NOM candy if store (also FP ≫ C⁰)
- c. *Ma-lápit lang ang b<in>ilí ng bátà ang ké^{ndi} (**saán**) kung tindáhan.
ADJ-near only NOM <PFV>buy[PV] GEN child NOM candy where if store (also F' ≫ DP)
- Intended: 'The store where the child bought the candy is nearby.'

Attempts for head-internal *kung*-RCs are shown in (54). Assuming this word order can be generated as a result of certain movement operations in (48) not occurring, we get examples like (54a-c). Alternatively, we might assume that the NP relative clause head first moves to a higher position before its remnant DP moves to Spec-FP, giving us (54d).

¹⁶Although note that Otsuka and Tanaka (2016) do not claim that their proposal derives the different word orders observed for linker RCs, so there is an additional level of uncertainty in evaluating this proposal in this way.

(54) ILL-FORMED HEAD-INTERNAL *kung*-RCs

- a. *Ma-lápit lang ang **kung** **saá[n]**(=ng) **tindáhan** b<in>ilí ng bátà ang kéndi.
ADJ-near only NOM if where=LK store <PFV>buy[PV] GEN child NOM candy (No B)
- b. *Ma-lápit lang ang (**kung**) b<in>ilí ng bátà ang kéndi **saá[n]**(=ng) **tindáhan**.
ADJ-near only NOM if <PFV>buy[PV] GEN child NOM candy where=LK store (No A/B)
- c. *Ma-lápit lang ang (**kung**) b<in>ilí **saá[n]**(=ng) **tindáhan** ng bátà ang kéndi.
ADJ-near only NOM if <PFV>buy[PV] where=LK store GEN child NOM candy (No A/B)
- d. *Ma-lápit lang ang **kung** **saán** b<in>ilí(=ng) **tindáhan** ng bátà ang kéndi.
ADJ-near only NOM if where <PFV>buy[PV]=LK store GEN child NOM candy

The impossibility of alternative word orders is unexpected under the unified analysis. Assuming that the core difference between linker RCs and *kung*-RCs is a primarily featural/lexical one ([FOC]/[NOM] vs [OBL]), it is not clear how one would derive flexible word order for the former but rigid word order for the latter. Thus, I take the difference in word order possibilities to be evidence that the two kinds of relative clauses actually have very different underlying structures.

4.3.3 Headless relatives

A second structural difference between linker RCs and *kung*-RCs that is unexpected under the unified analysis of Otsuka and Tanaka (2016) relates to whether or not they may appear headless. In this regard, linker RCs are again more flexible than *kung*-RCs, as only the former may surface without an overt relative clause head.

With a linker RC, the nominal head can be omitted entirely, resulting in what looks like a well-formed clause with a nominative gap that is directly marked with a determiner. The pervasiveness of this behavior in Tagalog is well-known, although it is occasionally analyzed as a construction distinct from relative clauses cross-linguistically (Schachter and Otnes 1972; Kaufman 2009; Law 2016; Aldridge 2017a). This headless relative clause is shown in (55), with the position normally occupied by a nominal head in a head-initial relative clause indicated with a blank. In contrast to the headless linker RC, the nominal head in *kung*-RCs cannot be omitted regardless of whether *kung* or the *wh*-expression (or both) are omitted as well, as shown in (56).

- (55) Ma-tamís ang ___ b<in>ilí ng bátà.
ADJ-sweet NOM <PFV>buy[PV] GEN child
'{The one that/What} the child bought is sweet.' Headless Linker RC
- (56) *Ma-lápit lang ang ___ (**kung**) (**saán**) b<in>ilí ng bátà ang kéndi.
ADJ-near only NOM if where <PFV>buy[PV] GEN child NOM candy
Intended: 'Where the child bought the candy is nearby.' Headless *kung*-RC

Apparent headless *kung*-RCs are possible if they are not marked with a determiner, as in (57). However, I assume that these are not the same kind of construction as *kung*-RCs, and refer to such examples as

FREE RELATIVES. These are discussed in more detail in Chapter 7, but crucially, there are two major points of difference between free relatives and *kung*-RCs in addition to the lack of a determiner.

- (57) Mag-ta~trabaho si Jenny **kung saan** b<in>ilí ng bátà ang kéndi.
 AV-FUT~work NOM Jenny if where <PFV>buy[PV] GEN child NOM candy
 'Jenny will be working where(ever) the child bought candy.'

First, free relatives have a more restricted distribution when appearing in argument positions. Compare the free relative and headed *kung*-RC in (58), for example.

- (58) a. Ma-lápit lang **ang tindahan kung saán** b<in>ilí ng bátà ang kéndi.
 ADJ-near only NOM store if where <PFV>buy[PV] GEN child NOM candy
 'The store where the child bought the candy is nearby.'
- b. *Ma-lápit lang **kung saán** b<in>ilí ng bátà ang kéndi.
 ADJ-near only if where <PFV>buy[PV] GEN child NOM candy
 Intended: 'Wherever the child bought the candy is nearby.'

Second, the free relatives may be constructed that abstract over DP positions as well. These also display the same *kung-wh* sequence, but note that DP free relatives are like DP focus constructions in that they have an *ang* following the *wh*-expression. Recall, on the other hand, that *kung*-RCs of DPs are impossible. This contrast is shown in (59).

- (59) a. Bi~bigy-an ko ng premyo **kung sino** ang makaka-sagot nang tama.
 FUT~give-LV 1SG.GEN GEN prize if who.NOM NOM NVOL.AV.FUT-answer GEN correct
 'I will give a prize to whoever can answer correctly.' ✓Free relative
- b. *Bi~bigy-an ko ng premyo ang **mag-aarál kung sino** ang makaka-sagot nang tama.
 FUT~give-LV 1SG.GEN GEN prize NOM student if who.NOM NOM NVOL.AV.FUT-answer GEN correct
 Intended: 'I will give a prize to the student who can answer correctly.' *Kung-RC

In light of these differences between linker RCs and *kung*-RCs, summarized in Table 4.3, a unified analysis of the two constructions is untenable.

Table 4.3: Structural diagnostics for focus constructions

	<i>Kung</i> -RC	LINKER RC
Head-initial order	✓	✓
Head-final order	✗	✓
Head-internal order	✗	✓
Headless relative	✗	✓

In summary, this chapter has discussed four constructions that Tagalog employs in the formation of A'-dependencies. These have non-overlapping distributions conditioned on the category of the dependency target. DP dependencies surface as linker relative clauses and pseudoclefts for focus, while non-DP dependencies surfaces as *kung* relative clauses and focus fronting constructions. Furthermore, it was shown that these constructions are structurally distinct from each other. For the focus constructions, we saw that focus fronting was amenable to a cross-linguistically typical A'-movement analysis, while pseudoclefts represent a periphrastic strategy, involving a DP-DP copular clause structure. Similarly, despite existing work proposing a unified structure for the two types of relative clauses, I showed that the relative clause head of a linker RC exhibits more flexibility than that of a *kung*-RC, suggesting that these constructions must in fact be structurally distinct.

In this thesis so far, I have established the necessary background on A'-dependencies (this chapter) as well as on the Philippine-type voice system found in this language (Chapter 3). In the remainder of this thesis, I propose concrete analyses of how these A'-dependency constructions are derived. The proposals developed in the following chapters will be informed by the structural differences between the different constructions that we have seen in this chapter. In particular, a central question to be addressed is why this structural asymmetry conditioned on the target's category (i.e., DP vs non-DP) should exist in the first place.

We will begin in Chapter 5 with the canonical DP-targeting dependencies that conform to the pivot-only restriction on A'-dependency formation, proposing a non-movement approach that is motivated by the periphrastic nature of pseudoclefts. To this end, Section 5.2 presents a formalization of the pseudocleft analysis for Tagalog (following previous work from Aldridge (2002) and Mercado (2004)), and proposes an account for why DPs in Tagalog may not undergo focus fronting, or for that matter, any kind of A'-movement conventionally construed. Section 5.3 and onwards then presents a *pro*-binding-based account of linker RCs, on which pseudoclefts are assumed to be built on. I then show in Chapter 6 that this proposal extends naturally to account for the distribution of DP dependencies that go against the pivot-only restriction. Finally, in Chapter 7, I propose an A'-movement-based account of non-DP dependency formation. Here, I discuss differences between DP- and non-DP-targeted A'-dependencies that motivate proposing two distinct mechanisms (*pro*-binding and A'-movement) for their formation, and situate the latter type of construction in the broader context of operations in Tagalog that target the left periphery.

Chapter 5

Deriving Voice-Agreeing DP Dependencies

This chapter makes two main claims about the syntax of Tagalog that have implications for the derivation of DP-targeted A'-dependencies in the language. The first is that movement of DPs in Tagalog is limited, due to a proposed locality restriction on Case licensing. Consequently, the second claim is that DP-targeted A'-dependencies in Tagalog are not formed by conventional A'-movement, but instead by a null pronoun, which I will call *pro*.

The primary empirical motivation for the proposal developed in this chapter is the structural asymmetry between pseudoclefts and focus fronting, the two types of focus constructions attested in Tagalog (discussed in Chap. 4). It will be shown that this structural asymmetry can be derived in a principled way under an extension of Béjar and Massam's (1999) Multiple Case Checking analysis (adopted in Chap. 3) where there are locality requirements not only on the PF-interpretability of Case, but also on Case licensing. The intuition pursued here is that DP A'-dependencies in Tagalog must be expressed as a pseudocleft construction, which is periphrastic, because DPs cannot have their Case licensing needs met in the regular clause-peripheral focus position. Conversely, non-DPs—which do not require Case licensing—may generally occupy this focus position without issue, so non-DP A'-dependencies are formed via conventional A'-movement, as discussed in Chapter 7. I show that this approach addresses an overgeneration problem faced by previous accounts of this asymmetry that has, to my knowledge, remained open.

In line with the claim of limited A'-movement for DPs, I propose that DP-targeted A'-dependencies in Tagalog ultimately rely on an alternative mechanism for formation. Specifically, I propose that DP-targeted relative clauses (i.e., linker RCs), which are a component of pseudoclefts, are formed from a null pronoun *pro* that introduces a free variable, which is subsequently bound by an operator that appears higher in the structure at the clause edge. This approach draws inspiration from previous null-pronoun-based analyses of relative clauses and similar constructions (particularly Toosarvandani 2014), but proposes a particular restriction on the distribution of *pro*. In this chapter and the next, I present a generalization that the binding relationship between *pro* and the operator shows a constraint on locality, and argue that this constraint can be satisfied in multiple ways, resulting in the observed distribution of

Tagalog DP-targeted A' -dependencies, including the cases that conform to the pivot-only restriction as well as those that do not. As we will see, the general consequence of this locality constraint is that a *pro* appearing in the thematic domain (e.g., within vP) is insufficiently local to the clause-edge operator (in most instances). In this chapter specifically, I claim that pivot movement (i.e., movement to Spec-AgrP) is one process that feeds satisfaction of the locality constraint. This in turn derives the subset of A' -dependencies that conform to the well-known pivot-only restriction on A' -dependencies in this language, which is the empirical focus of this chapter. Within this subset, I demonstrate how the proposal derives the basic cases of local dependencies, then turn to more complex long-distance dependencies. I show how the non-movement approach proposed here is able to account for apparent successive-cyclic effects while, again, avoiding overgeneration problems faced by alternative analyses. In Chapter 6, I discuss other ways in which the locality requirement on the binding of *pro* can be satisfied, and how this derives the distribution of exceptions to the pivot-only restriction. Crucially, I will show in Chapter 7 that this overall picture of locality differs between the non-movement *pro*-based approach for DP dependencies and the conventional A' -movement-based approach for non-DP dependencies.

I begin by providing a detailed overview of the analysis, discussing its major points and the main motivating empirical puzzle.

5.1 Proposal overview

The main motivation for the analysis I propose in this chapter is the observation laid out in Section 4.2 that focus constructions (including *wh*-questions) of DPs in Tagalog have the form of pseudoclefts (following Aldridge 2002; Mercado 2004; Paul 2001; Potsdam 2009; Richards 1998, among others). Under this view, these constructions have the structure of a copular clause, where the (clause-initial) predicate is the focus- or *wh*-phrase and the subject is a relative clause consisting of the presupposed content. An example highlighting the pseudocleft structure is given in (1), along with a mirror English paraphrase. Recall also that the relative clause subject may be headed or headless.

- (1) [_{Pred} Ang barako=ng iyan] [_{Subj} ang (kape=ng) ini~inom ni Gina].
 NOM barako.coffee=LK MED NOM coffee=LK IMPF~drink[PV] GEN.P Gina

‘[What Gina drinks] is [that barako coffee].’

‘[The coffee that Gina drinks] is [that barako coffee].’

DP pseudocleft

One conclusion that can be drawn from this structure (particularly the presence of the relative clause subject) is that the focus- or *wh*-phrase does not come to occupy its surface position by straightforward A' -movement from a base position within the presuppositional constituent labeled “Subj” in (1). Rather, the two stand in a predication relationship. We have also seen that this DP focus structure contrasts with non-DP focus structure. As discussed in Chapter 4, non-DP focus constructions like (2) do not take the form of pseudoclefts, and thus are more amenable to a more typical A' -movement analysis. This observation would then suggest that A' -movement of DPs in Tagalog is somehow more restricted than that of non-DPs, since the former rely on a periphrastic construction to form focus constructions.¹

¹Richards (1991) made this same observation about DP movement appearing more restricted, pointing out that this behavior is problematic for the standard theories of extraction at the time, which were based on the Empty Category Principle.

- (2) [Foc Sa kapihan] ako lagi nagba~basa ng libro.
 OBL cafe 1SG.NOM always AV.IMPF~read GEN book

‘It’s at the cafe that I always read books.’

Non-DP focus fronting

The analysis presented in this chapter takes this observation regarding the restricted nature of DP *A'*-movement as fundamental, and posits that *A'*-dependencies of DPs are in fact *not* formed via traditional *A'*-movement. I propose that the driving force behind this restriction is Case, specifically through an extension to Béjar and Massam’s (1999) Multiple Case Checking (MCC) analysis. As discussed in Chapter 3, their analysis proposes that, as a point of parametric variation, Case in some languages (including Tagalog, as I propose) is only PF-interpretable locally to its assigning head. When a DP assigned Case undergoes movement, this locality requirement effectively causes the Case value assigned to the DP to be “left behind” in the launching site, allowing the moved DP to receive another value of Case in the landing site of movement.

Here, I propose that Tagalog is a language where the locality requirement on the interpretability of Case is stronger than originally proposed for certain languages by Béjar and Massam (1999). They (p.75) note that in the languages they consider, *A'*-movement to a higher position preserves the Case value assigned to a DP in a lower position. From this observation, they conclude that the locality requirement they propose is active only with A-movement. For Tagalog, however, I posit that the locality requirement is active with all types of movement, not just A-movement. The primary consequence of this proposal is that DPs are predicted to only be able to undergo movement to positions where Case is assigned, as they would otherwise have no abstract Case, and therefore not be Case licensed. In Section 5.2, I spell out how this derives the asymmetry between the pseudocleft structure of DP focus and the focus fronting structure of non-DP focus.

Outside of focus constructions, I also show in this chapter how the proposed restrictions to DP movement affect the formation of linker RCs. I propose that the formation of these relative clauses involves a null pronoun *pro*, which introduces a semantic variable and is bound by an operator at the clause edge, resulting in a construction that is semantically a predicate of individuals and can subsequently be used in modificational contexts. I further claim that *pro* and the operator must be sufficiently local to each other for this binding to be successful. In most cases where *pro* appears in the thematic domain (*vP*), it is insufficiently local to the operator, and must therefore escape.² Assuming that *pro* is like other (pronominal) DPs, particularly in terms of Case licensing requirements and consequently movement possibilities (following the extension of the MCC analysis outlined above), the strategies available for escaping the thematic domain are limited to those that leave *pro* in a Case position. I discuss this proposal in detail in Section 5.3, where I spell out how key properties of linker RCs are derived. In particular, I show that one way for *pro* to escape the thematic domain is through pivot movement to Spec-AgrP, deriving the behavior that conforms to the pivot-only extraction restriction.

Following this, I consider in detail the implications of the non-movement aspect of this analysis for long-distance dependencies. The pronoun-based approach advanced in this chapter is strongly reminiscent of previous analyses of phenomena such as resumptive pronoun relative clauses in Irish (McCloskey

²In Sec. 6.5, I argue that reduced structure of a particular type obviates this need for escape, allowing *pro* to be bound by the operator.

2002), as well as individual-denoting nominalizations with clausal or clause-like structure in a number of languages (e.g., Bliss 2014; Salanova 2011; Toosarvandani 2014). An important consequence for such analyses, spelled out by McCloskey (2002), is that they should lack certain signatures of movement, such as successive-cyclic behaviors. This would appear to pose a problem for the current analysis, as the Tagalog pivot-only restriction does exhibit successive-cyclic behavior. I show in Sections 5.4–5.6, however, that the analysis can be extended to account for such behavior, and that in particular, it avoids problems that movement-based analyses encounter with respect to apparent long-distance extraction of non-DPs.

Overall, then, I show in this chapter that the non-movement approach proposed here adequately accounts for the properties of voice-agreeing DP A' -dependencies in Tagalog. This forms part of the analysis of the overall landscape of A' -dependencies in this language. Looking ahead, I discuss in Chapter 6 how *pro* can be used to derive the range of apparent exceptions to the Tagalog pivot-only restriction (i.e., where the dependency targets genitive-marked positions), and show that the distribution of such apparent exceptions exhibit the claimed locality constraint on the binding of *pro*. In Chapter 7, I discuss the other side of the coin, non-DP dependencies, arguing that these constructions can be derived by A' -movement and show a locality signature distinct from the *pro*-based mechanism.

5.2 DP focus as pseudoclefts

Let us begin by considering in detail the behavior of DP focus constructions. Many observations and concrete analyses have been made in previous work on Tagalog and other Austronesian languages regarding the pseudocleft status of focus constructions that target DPs (Aldridge 2002; Mercado 2004; Paul 2001; Potsdam 2009; Richards 1998, among others). Here, I follow this analytical thread and adopt the view that DP focus constructions have the structure of a copular clause of a specific shape. As the general structure schematized in (3) illustrates, I assume that the focus phrase is a referential or *wh*-DP serving as the sentential predicate (which appears in the typical clause-initial position), while the sentential subject is a relative clause (typically but not obligatorily headless) corresponding to the presuppositional statement.

- (3) [_{Pred} Ang kalabaw] [_{Subj} ang nali~ligo sa ilog].
 NOM water.buffalo NOM AV.IMPF~bathe OBL river
 ‘[What’s bathing in the river]_{Subj} is [the water buffalo]_{Pred}.’

As mentioned at the beginning of this chapter, I assume that the focus-/*wh*-phrase does not originate from some base theta-position within the headless relative subject. In keeping with this assumption, I adopt a formal analysis for pseudoclefts as specificational clauses, similar to those proposed by Mercado (2004); Or (2015) for Tagalog and Mikkelsen (2005b); Moro (1997) for English. I first discuss the general outline of the analysis as implemented within the phrase structure that I assume. Nothing about the general pseudocleft structure I adopt here is new, and previous accounts have even contrasted such structure with the structure of non-DP focus constructions (particularly Aldridge 2002; Mercado 2004). However, I point out a major question about the asymmetry between DP and non-DP focus constructions that, to my knowledge, has been left unanswered by previous analyses. We will see that these analyses correctly arrive at the structural differences between these focus constructions by assuming different derivational

starting points, but it is unclear what motivates the assumed base structures in the first place. To account for this, I propose an extension to Béjar and Massam's (1999) MCC analysis that restricts DP movement to only be possible to positions where abstract Case is available.

5.2.1 Focus as a copular clause

I follow the general structure of copular (i.e., non-verbally predicated) clauses outlined in Section 3.5, and shown again below in (4) for a nominally predicated clause. To recap, I assume the existence of a PredP projection that serves to mediate the predication relation, with the semantic subject introduced in its specifier position, and the semantic predicate as its complement. Above PredP are AgrP and IP, which have the following functions. Recall from Sections 3.1 and 3.2 that Agr⁰ (not I⁰) is the source of abstract nominative Case in a clause, which is assigned to its specifier.³ In this case, it is the subject DP in Spec-PredP, bearing [PIVOT], that moves to Spec-AgrP and receives nominative. On the other hand, the role of I⁰, which selects AgrP, is to generate the predicate-initial word order of the clause, which is accomplished by [*u*PRED] triggering remnant movement of PredP to Spec-IP, following Massam and Smallwood (1997) and Massam (2000). Note also that the relative hierarchical positions of AgrP and IP were motivated in Section 3.1.2 based on an implicational hierarchy whereby the voice morphemes (Agr⁰) were attested without aspect morphology (I⁰), but not vice versa.

- (4) a. Tagahanga ni Nora Aunor ang mga magulang ko.
 admirer GEN.P Nora Aunor NOM PL parent 1SG.GEN
 'My parents are admirers of Nora Aunor.'

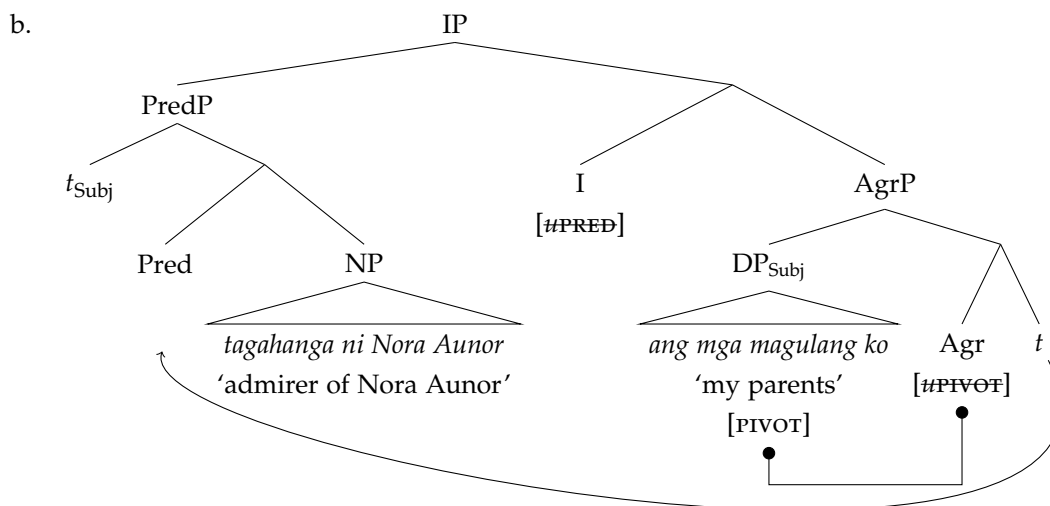

Turning to pseudoclefts (i.e., DP focus constructions), I closely follow the intuition behind the analysis proposed by Mercado (2004), as well as predicate inversion analyses of specificational clauses more generally (Heggie 1988; Mikkelsen 2005a; Moro 1997). I formalize this approach within the specific phrase structure proposed in this thesis. The idea is straightforward: instead of merging a projection like NP as the complement of Pred⁰, we merge in this position a predicative DP, such as a (headless) relative

³In verbally predicated clauses, Agr⁰ is also the head that spells out one of the voice morphemes.

clause. For (5), we thus have the PredP structure in (6), with a referential DP in semantic subject position (Spec-PredP) and a headless relative DP in semantic predicate position (Comp-Pred).

- (5) Ang mga magulang ko ang nano~nood ng mga pelikula ni Nora Aunor.
 NOM PL parent 1SG.GEN NOM AV.IMPF~watch GEN PL movie GEN.P Nora Aunor
 ‘The ones who watch Nora Aunor’s movies are my parents.’

(6) PREDICATIONAL CORE FOR COPULAR CLAUSES WITH A DP PREDICATE

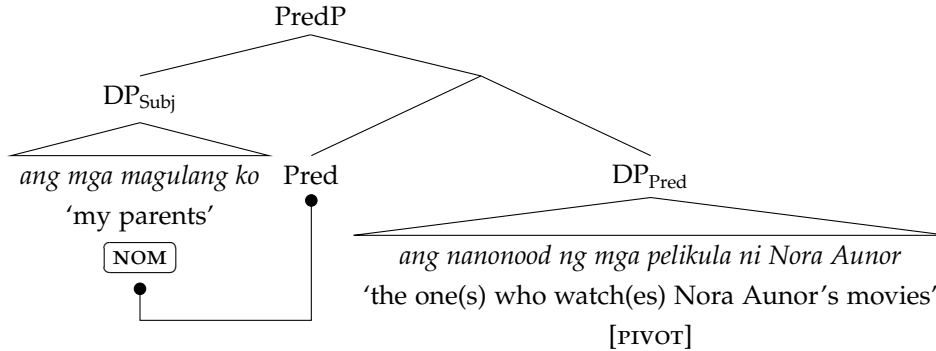

Recall also from Section 3.5 that I assume $Pred^0$ assigns abstract nominative Case to its specifier. We saw in that section that this Case assignment leads to two instances of abstract nominative Case being assigned to the semantic subject. Here, we will see a slightly different scenario.

Following the evidence from Section 4.2 of the presuppositional statement’s syntactic subjecthood, I assume that DP_{Pred} bears a [PIVOT] feature. This will result in Agr^0 targeting DP_{Pred} instead of DP_{Subj} for movement to Spec-AgrP and subsequent nominative Case assignment. Once I^0 enters the derivation, it triggers remnant movement of PredP to its specifier position, in line with the derivation previously shown for other types of copular clauses like (4b). The result is shown in (7). Note that both DPs in this derivation are licensed, having each received nominative Case from a different head (i.e., $Pred^0$ and Agr^0).

(7) IP STRUCTURE FOR DP-PREDICATE COPULAR CLAUSE

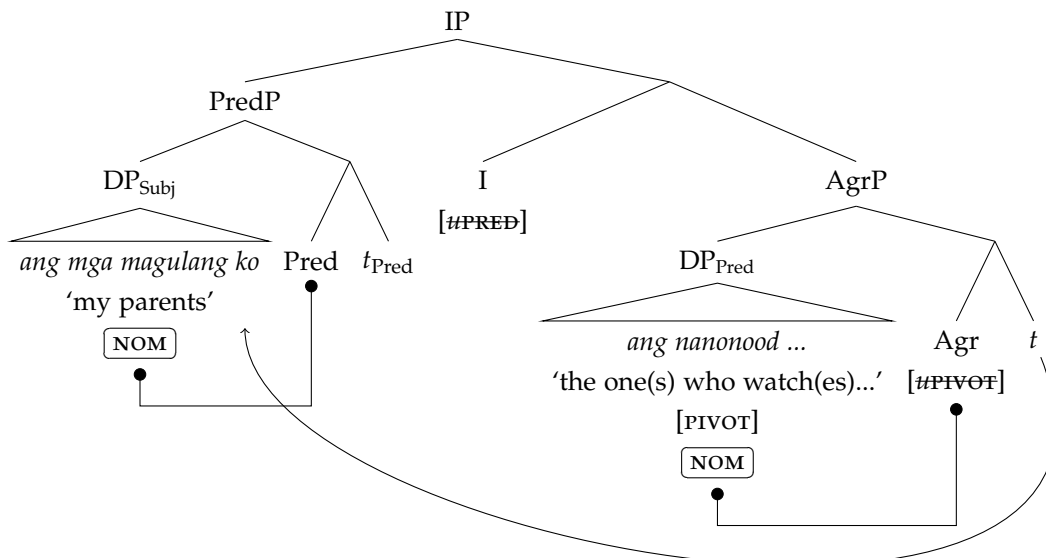

Pseudoclefts thus have the structure of specificational copular clauses, particularly following the intuition behind the predicate inversion type of analysis proposed for other languages like English (e.g., Mikkelsen 2005a,b; Moro 1997). Such analyses assume a shared base predication structure (i.e., PredP) that results in different surface structures depending on the specific operations applied to it. For specificational copular clauses, we have a sort of reversal of the base predication structure, where the semantic subject appears in the syntactic predicate position and vice versa. This configuration is what we see in (7), with DP_{Pred} appearing in Spec-AgrP, and DP_{Subj} appearing (perhaps indirectly) in Spec-IP.

The discussion here admittedly sidesteps the rich literature on copular clauses, within which much debate exists on their classification and analysis. In the area of specificational clauses, an alternative to the predicate inversion approach adopted here is from Romero (2005), who argues that instead of inversion, the key property of specificational clauses is semantic in nature: that specificational clause subjects share properties in common with concealed questions (see also Arregi et al. 2018). Thus the structure of specificational clauses is argued to be inherently predicational, but predication is not of individuals (type e), but of individual concepts (intensionalized individuals, of type $\langle s, e \rangle$). This account and other works in this area tease apart different types of (particularly DP-DP) copular clauses by making use of various diagnostic properties, such as the internal structure of the DPs involved (e.g., definite description vs free relative), the form and obligatoriness of relational elements like copulas in different contexts, and the presence of connectivity effects (Adger and Ramchand 2003; den Dikken 2006). It turns out that many of these diagnostics are not straightforward to apply to Tagalog. For example, Tagalog simply does not have an overt copula in most if not all contexts (see Richards 2009b for some discussion). More work is thus needed to ascertain the full validity of applying the predicate inversion analysis to Tagalog pseudoclefts.

That being said, I argue here that, at the very least, DP focus constructions in Tagalog should be analyzed in the same way as the more general type of DP-DP clause that is found in this language. Such an approach is supported by a number of parallel behaviors between the two construction types. We have seen some of these parallels in Section 4.2, but here I discuss two more: a shared word order restriction and shared information structure.

First, let us consider the word order of pseudoclefts, which we will see is reflected in other DP-DP clauses as well. We saw in (5) that in a focus construction, DP_{Subj} , which is a common noun DP, linearly precedes DP_{Pred} , which is a headless relative clause. This word order was generated by movement of DP_{Pred} out of PredP to Spec-AgrP (facilitated by [PIVOT]), and then movement of the remnant PredP to the higher Spec-IP position.

Given the assumed free distribution of [PIVOT], we can consider an alternative scenario where this feature appears on DP_{Subj} instead of DP_{Pred} . The result of this change would be a sentence like (5), but with the relative order of DP_{Subj} and DP_{Pred} reversed. As (8) shows, however, this reversed word order is ungrammatical.

- (8) * $[_{Pred}$ Ang nano~nood ng mga pelikula ni Nora Aunor] $[_{Subj}$ ang mga magulang ko].
 NOM AV.IMPF~watch GEN PL movie GEN.P Nora Aunor NOM PL parent 1SG.GEN
 Intended: 'My parents are the ones who watch Nora Aunor's movies.' (cf. 5)

The current proposal accounts for the ill-formedness of (8) straightforwardly as a problem of Case

licensing. Consider the tree (9), where Case assignment is highlighted. Here, we see that DP_{Subj} bears [PIVOT], so it is this DP that comes to occupy Spec-AgrP and receives nominative Case from Agr^0 . On the other hand DP_{Pred} remains in Comp-Pred, which I assume is not a Case position (in contrast to Spec-PredP). Intuitively, this assumption is in line with the idea that XPs of lexical categories (i.e., N, V, A, P) constitute prototypical copular clause predicates, while DPs do not, resulting in their cross-linguistic tendency to behave differently when appearing as such predicates (see, e.g., Adger and Ramchand 2003). The Caselessness of Comp-Pred can thus be tied to the fact that the lexical categories are standardly assumed to not require Case licensing. Consequently, DPs that are generated in this position, such as DP_{Pred} in (9), are not Case licensed, so examples like (8) are correctly ruled out.

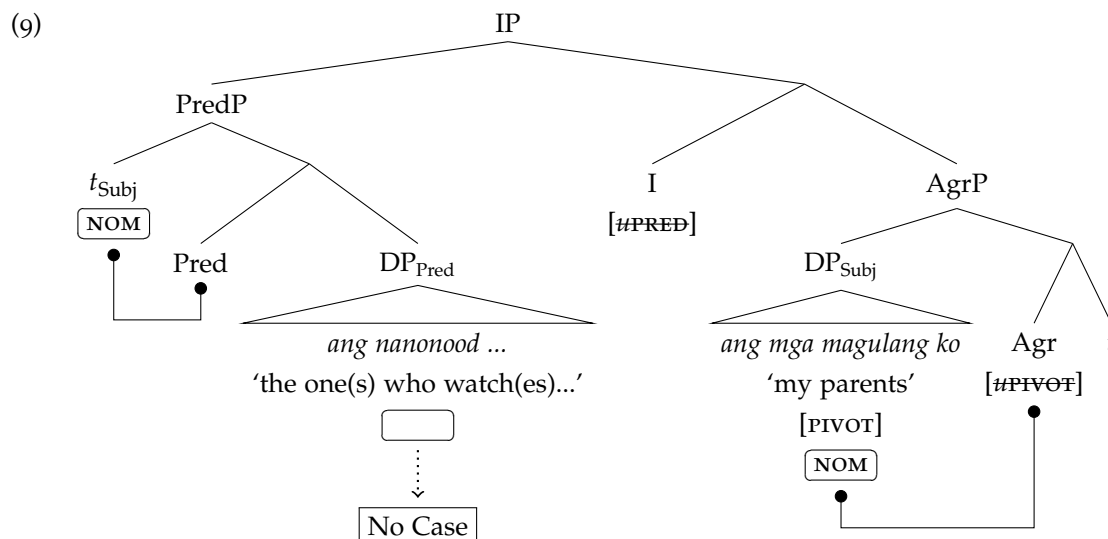

Significantly, although the examples we have considered so far happen to be (used as) focus constructions, nothing about this account of the word order restriction relies on this fact. Instead, we expect this account to generalize to any structure involving a PredP with DPs in both specifier and complement positions (i.e., DP-DP clauses more generally). This is borne out, as we find parallel word order restrictions in such structures.

Informally speaking, the behavior we find with DP-DP clauses more generally is that the more referential of the two DPs in such constructions must appear *before* the more predicative one. For pseudoclefts, we can compare (5) and (8) to see that headless relatives unsurprisingly count as more predicative than common noun DPs for the purposes of this restriction. Likewise, examples (10-11) show that this ordering restriction is active with other types of DPs as well. The symbol “>” here is used to mean “linearly precedes”.

(10) PRONOUN > PROPER NAME

a. [Ako] [si Henrison].

1SG.NOM NOM Henrison

‘I am Henrison.’

b. *[Si Henrison] [ako].

NOM Henrison 1SG.NOM

Intended: ‘I am Henrison.’

(11) PROPER NAME > COMMON NOUN

a. [Si Fe] [ang guro].

NOM Fe NOM teacher

‘Fe is the teacher.’

b. *[Ang guro] [si Fe].

NOM teacher NOM Fe

Intended: ‘Fe is the teacher.’

If we assume a semantically motivated restriction on the XPs that merge with Pred^0 such that the specifier of this projection must be at least as referential as the complement, then the generalized word order restriction falls out naturally. For concreteness, (12-13) show the derivations for (11).

(12) ✓PROPER NAME > COMMON NOUN (11a)

(13) *COMMON NOUN > PROPER NAME (11b)

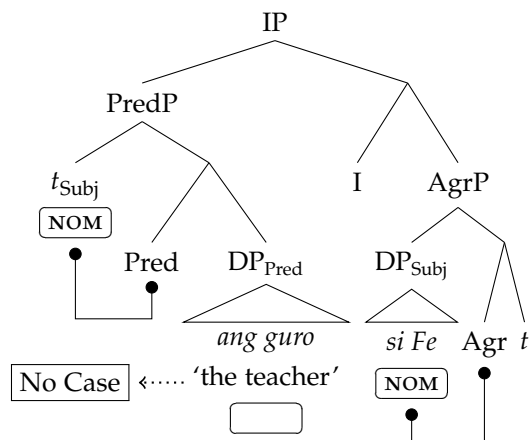
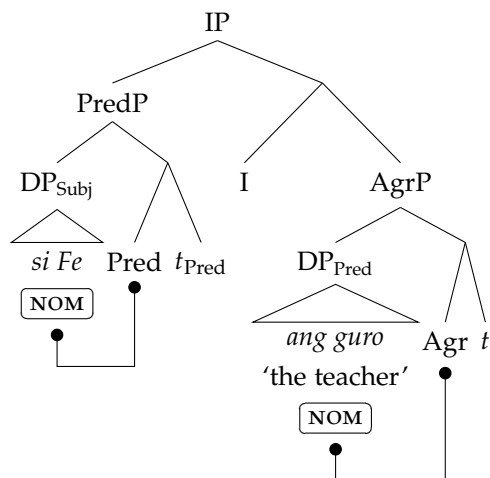

The second parallel behavior between pseudoclefts and DP-DP copular clauses is with respect to their interpretation. In a pseudocleft, the focus constituent appears linearly first in the clause. As the clause-initial position is the basic position for predicates in Tagalog, and we typically associate clausal predicates as conveying information-structurally new content, the actual focus/new interpretation of the focus constituent is expected. Along the same lines, the fact that the presuppositional statement occurs in clausal subject position (i.e., following the predicate) is consistent with its topic or given status. Furthermore, Mercado (2004), using Szabolcsi's (1981) exhaustivity test, notes that the focused element in Tagalog pseudoclefts is interpreted exhaustively. Thus, the sentences in (14) cannot be simultaneously true, showing that (14b) must be interpreted as 'Juan and no one else (in the relevant domain of people) went to Boracay'.

(14) EXHAUSTIVITY IN TAGALOG PSEUDOCLEFTS

(Mercado 2004, ex.13)

- a. **Sina Juan at Diego** ang p<um>unta sa Boracay.
 NOM.P.PL Juan and Diego NOM <AV>go(PFV) OBL Boracay
 'It was Juan and Diego who went to Boracay.'
- b. **Si Juan** ang p<um>unta sa Boracay.
 NOM.P Juan NOM <AV>go(PFV) OBL Boracay
 'It was Juan who went to Boracay.'

Again, we find the same exhaustivity in other kinds of DP-DP copular clauses. This is shown with the sentences in (15), which have common noun subjects. As with (14), these two sentences cannot be simultaneously true, showing that the linearly first DP in (15b) must be interpreted as 'Zsazsa and Yeng and no one else (in the relevant domain of people)'.

(15) EXHAUSTIVITY IN OTHER DP-DP CLAUSES

- a. **Sina Zsa Zsa, Yeng at Kristine** ang mga guro ni Angel.
 NOM.P.PL Zsa Zsa Yeng and Kristine NOM PL teacher GEN.P Angel
 ‘Angel’s teachers are Zsa Zsa, Yeng, and Kristine.’
- b. **Sina Zsa Zsa at Yeng** ang mga guro ni Angel.
 NOM.P.PL Zsa Zsa and Yeng NOM PL teacher GEN.P Angel
 ‘Angel’s teachers are Zsazsa and Yeng.’

Having shown that the properties of pseudoclefts fall out very naturally by assuming that they are in fact copular clauses, I turn to a major question that is perhaps obscured by the simplicity of the analysis just presented. Why does Tagalog resort to what amounts to a periphrastic (i.e., non-dedicated) structure for DP focus?

5.2.2 Motivating the base structure

In the analysis presented in the previous subsection, it was simply assumed that pseudoclefts are generated from a base structure where a referential DP and a headless relative clause stand in a predication relationship. This assumption leaves a major question unanswered: why should this be the underlying structure of DP focus constructions? We saw in Chapter 4 that Tagalog has available another focus construction, focus fronting, which is used for non-DP focus. Recall that this construction is identifiable by (i) the absence of *ang*-marking on the presuppositional statement and (ii) attachment of second-position clitics to the focus phrase, as shown in (16) with the second position clitic pronoun underlined. We further saw that focus fronting cannot be used to focus DPs, as illustrated by the ungrammaticality of (17a). Compare this with the grammatical pseudocleft (17b).

(16) FOCUS FRONTING WITH NON-DP FOCUS

- [Sa gubat]_i natin maki~kita ang mga tarsier *t_i*.
 OBL jungle 1PL.INCL.GEN NVOL.FUT~see[PV] NOM PL tarsier
 ‘It’s in the jungle that we will see the tarsiers.’

(17) FOCUS STRATEGIES TARGETING DPs

- a. *[Ang mga tarsier]_i natin maki~kita *t_i* sa gubat.
 NOM PL tarsier 1PL.INCL.GEN NVOL.FUT~see[PV] OBL jungle
 Intended: ‘It’s the tarsiers that we will see in the jungle.’ *Focus Fronting
- b. [_{Pred} Ang mga tarsier] [_{Subj} ang maki~kita natin sa gubat].
 NOM PL tarsier NOM NVOL.FUT~see[PV] 1PL.INCL.GEN OBL jungle
 ‘What we will see in the jungle are the tarsiers.’ Pseudocleft

Why is (17a) ruled out? In Chapter 7, I propose that the focus fronting construction is derived by A’-movement of an XP to a clause-peripheral focus position. Such a movement operation should *a priori*

apply equally to DPs and non-DPs, yet (17a) tells us that this cannot be the case in Tagalog. The task now is thus to exclude this movement possibility for DPs.

The explanatory route I pursue here, as mentioned at the beginning of this chapter is to argue that DPs cannot undergo A'-movement. I formalize this by extending Béjar and Massam's (1999) Multiple Case Checking (MCC) analysis as discussed in Chapter 2. Recall that their proposal posits that in some languages, Case features are PF-interpretable only when they are local to the assigning functional head. This means that if a Case-valued DP moves, its Case value does not "move with" it, instead remaining on the trace of movement. The moved DP may then receive another value of Case in its landing site. Put differently, a single movement chain can get multiple instances of Case, but segments of this chain are still limited to one.

In Chapter 2, I argued that MCC is independently necessary for Tagalog as it accounts for the nominative-genitive (i.e., *ang-ng*) alternations we find with core arguments like the one shown in (18) while still treating nominative (i.e., *ang*-marking) formally as the reflex of structural Case (contra, e.g., Rackowski 2002; Chen 2017).

(18) NOMINATIVE-GENITIVE ALTERNATIONS IN TAGALOG

- a. Ng<um>a~ngatngat ang aso ng ma-laki=ng buto.
 AV.IMPF~gnaw NOM dog GEN ADJ-big=LK bone
 'The dog is gnawing a big bone.'
- b. Ng<in>a~ngatngat ng aso ang ma-laki=ng buto.
 IMPF~gnaw[PV] GEN dog NOM ADJ-big=LK bone
 'The dog is gnawing the big bone.'
- c. ang pag-ngatngat ng aso ng ma-laki=ng buto
 NOM IMPF~gnaw[PV] GEN dog GEN ADJ-big=LK bone
 'the dog's gnawing of a big bone'

In their original proposal, Béjar and Massam (1999) were mainly concerned with accounting for raising configurations in languages like Niuean, Hungarian, and Icelandic where both the head and tail of the raising chain demonstrably receive Case. As such, they limit the scope of their proposed locality requirement to A-movement (i.e., movement to positions where Case is assigned), stating that they "assume that *wh*-chains have access to the head of their A-chain at PF, in order to account for the fact that *wh*-words bear the Case assigned to the head of their A-chain." This restriction to A-movement is ultimately a stipulation necessitated by the range of data considered. I propose here that such a stipulation is not necessarily a universal among languages, but is instead a point of cross-linguistic variation. Thus, languages can vary not only in whether or not Case moves with a DP undergoing A-movement, as Béjar and Massam show for English versus Niuean/Hungarian/Icelandic, but also whether or not Case moves with a DP undergoing movement in general. I propose here that Tagalog is an instance of such a language where Case does not move with DPs undergoing movement. That is, Case in this language is *generally* PF-interpretable only in a checking configuration with the assigning functional head, so any value of abstract Case assigned to a DP that subsequently moves must remain on the trace of that movement.

Assuming that A'-movement is typically to positions that are Caseless, this extension of the MCC proposal allows for situations where DPs have no Case value after movement, as sketched in (19), where Spec-FP is a Caseless position. Note that this configuration creates some ambiguity regarding the licensing status of the moved DP, specifically under the assumption that such licensing relies on abstract Case assignment, and so a more precise formulation is needed. Two conceptual possibilities become distinguishable in this configuration, that otherwise yield identical outcomes in non-MCC approaches to abstract Case as well as A-movement-restricted MCC proposal of Béjar and Massam (1999). On one hand, if we assume that a DP is licensed as long as it has been assigned Case at some point in the derivation (i.e., Case is assigned to some segment of its movement chain), then the moved DP in (19) is licensed. On the other, if we assume that a DP requires a value of abstract Case in its surface position in order to be licensed, regardless of Case assignment in any lower positions (i.e., it may “lose” licensing), then the moved DP is not licensed. I posit that the latter holds in Tagalog.

(19) MOVEMENT TO A CASELESS POSITION

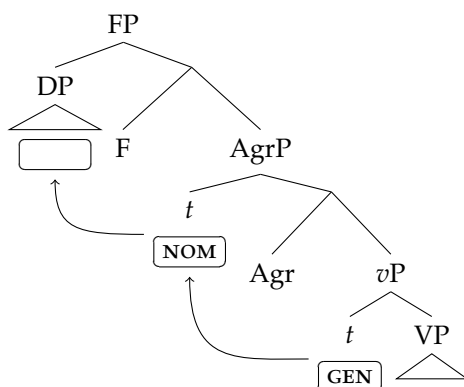

The major consequence relevant for present purposes is then that we now have a principled way to rule out instances of DP focus fronting, like (17a). Assuming that no Case is available in the landing site of focus fronting (i.e., the clause-peripheral focus position), movement of a DP to this position will result in a crash due to this DP ending up without a value for Case. The impossibility of the focus fronting construction for DP focus in turn allows us to understand why the periphrastic pseudocleft construction is necessary. Having discussed the general idea of the proposal, let us now consider some concrete examples to see how the locality requirement on the interpretability of Case interacts with the focus constructions.

First, we have pseudoclefts. The proposed structure for these constructions is repeated in (20). As previously discussed, I assume that these involve a DP-DP predicational structure mediated by PredP where [PIVOT] appears on the semantic predicate DP_{Pred} (i.e., the complement of $Pred^0$). DP_{Pred} thus moves to Spec-AgrP where it receives nominative Case, and PredP undergoes remnant movement to Spec-IP. In order to license DP_{Subj} , I assume that $Pred^0$ generally assigns nominative Case to its specifier.

(20) IP STRUCTURE FOR DP-PREDICATE COPULAR CLAUSE

- a. Ang pusa ni Eddie ang nali~ligo sa ilog.
 NOM cat GEN.P Eddie NOM AV.IMPF~bathe OBL river
 ‘What’s bathing in the river is Eddie’s cat.’

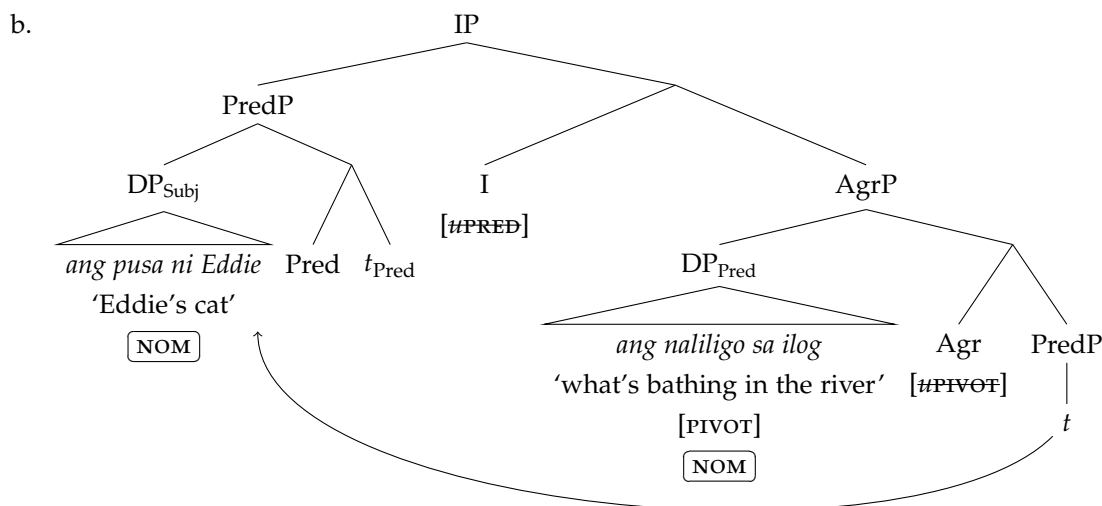

Now let us consider what goes wrong when we attempt to focus front a DP. I assume that the landing site of focus fronting is not the position occupied by the focus phrase in a pseudocleft (contra Mercado 2004). Instead, this position lies in the clausal left periphery, crucially higher than Spec-IP (following Aldridge 2002). Concretely, I adopt Rizzi's (1997) articulated left periphery approach, and propose that this kind of focus constituent moves to Spec-FocP. Further implications of the articulated left peripheral structure are discussed in more detail in Chapter 7, which deals with non-DP dependencies generally. For now, I limit the discussion of this expanded structure to FocP, contrasting it with the position occupied by DP focus constituents.

Clear evidence for this higher landing site comes from non-DP focus fronting out of copular clause structures, shown in (21) with corresponding non-focus clauses in (22).⁴ We see that such constructions are possible, and that the focus phrases must precede the predicational head (i.e., *dalubhasa* 'expert' and *magalíng* 'skilled').

(21) FOCUS FRONTING FROM COPULAR CLAUSES

- a. **Sa physics at chemistry** dalubhasa si Marie Curie.
 OBL physics and chemistry expert NOM.P Marie Curie
 'It's physics and chemistry that Marie Curie was an expert in.' Nominal predicate
- b. **Sa linguistics** ma-galíng si Noam Chomsky.
 OBL linguistics ADJ-skill NOM.P Noam Chomsky
 'It's linguistics that Noam Chomsky is good at.' Adjectival predicate

(22) BASELINE COPULAR CLAUSES

- a. Dalubhasa **sa physics at chemistry** si Marie Curie.
 expert OBL physics and chemistry NOM.P Marie Curie
 'Marie Curie was an expert in physics and chemistry.' Nominal predicate

⁴Sabbagh (2014, pp.6–10) also argues that non-DP *wh*-expressions must appear above Spec-IP on the basis of relative ordering with respect to various kinds of adverbs.

- b. Ma-galing **sa linguistics** si Noam Chomsky.
 ADJ-skill OBL linguistics NOM.P Noam Chomsky

‘Noam Chomsky is good at linguistics.’

Adjectival predicate

If we maintain that non-verbal predicates occupy Spec-IP due to the EPP [*u*PRED] feature, then it is clear that the focus phrases in (21) must be higher in the structure, as illustrated in (23).

- (23) STRUCTURE FOR (21a)

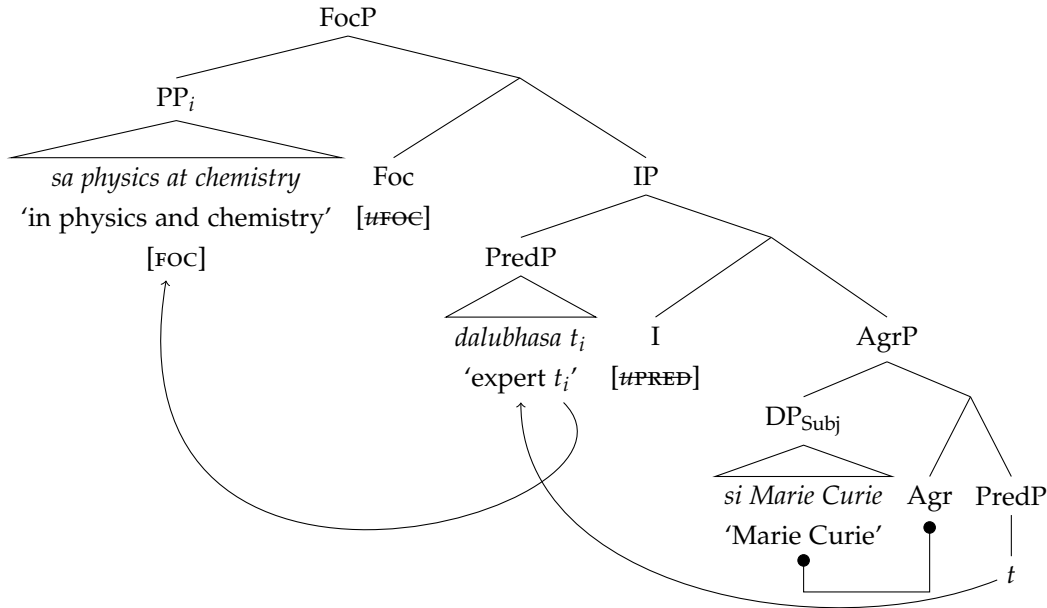

Let us then assume straightforwardly that Foc^0 does not assign Case, and therefore that Spec-FocP is not a Case-checking position. Following the extension proposed above to the MCC analysis of Béjar and Massam 1999, we predict that DPs that move to this position will not have a Case value, regardless of whether they have received Case previously in lower positions, and will therefore not be licensed. An example derivation is shown in (24b), which takes a verbally predicated clause as its base structure. The intended focus DP, (*ang*) *pusa ni Eddie* ‘Eddie’s cat’, receives Case in two positions: genitive in Spec-*v*P and nominative in Spec-AgrP, since it is the pivot of the clause. However, once this DP moves higher, it effectively leaves behind these previously assigned values of Case, and because its final landing site is not a Case position, it ends up without a Case value, causing the derivation to crash.

- (24) ILLICIT DP FOCUS FRONTING

- a. **Ang pusa ni Eddie ang nali~ligo sa ilog.*
 NOM cat GEN.P Eddie AV.IMPF~bathe OBL river

Intended: ‘It’s Eddie’s cat that’s bathing in the river.’

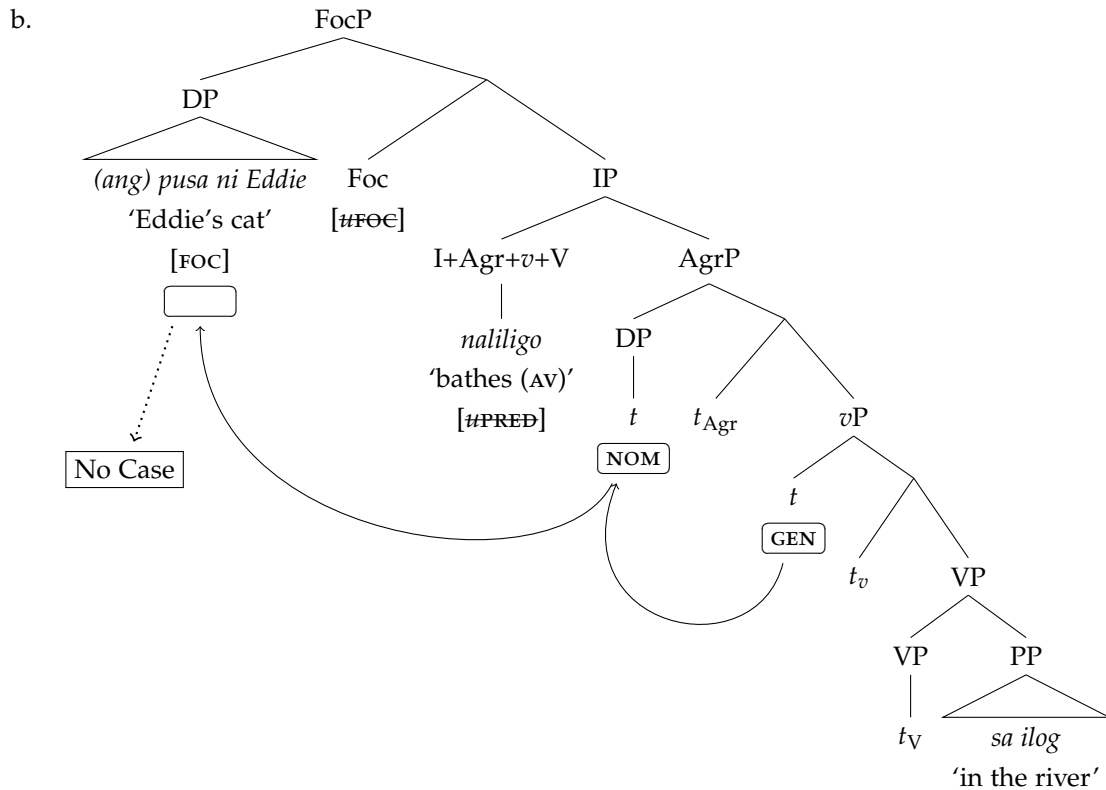

In contrast to the ill-formed derivation (24b), (25b) shows an alternative derivation where the focus constituent is a PP; compare also the well-formed (23). In this case, the derivation converges because PP does not require Case, and therefore may occupy Spec-FocP.

(25) LICIT PP FOCUS FRONTING (*cf.* 24)

- a. *Sa ilog ang nali~ligo ang pusa ni Eddie.*
 OBL river AV.IMPF~bathe NOM cat GEN.P Eddie
 'It's in the river that Eddie's cat is bathing.'

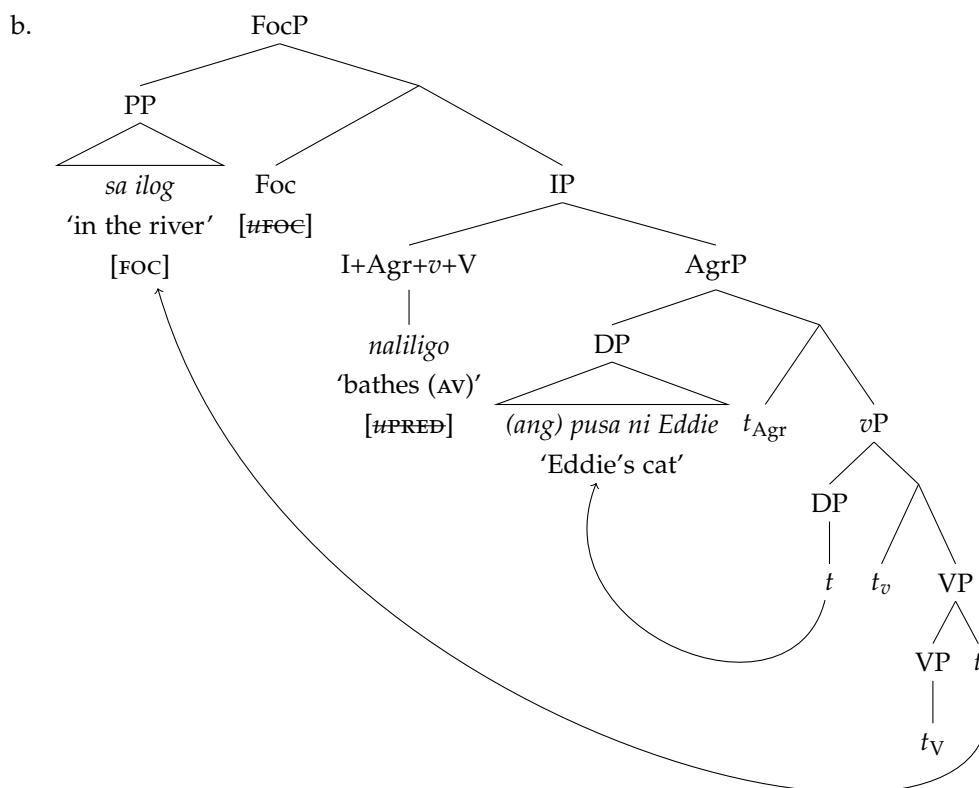

The structural split between DP and non-DP focus is thus captured as a problem of Case. The process of focus fronting involves movement to Spec-FocP. As this is not a position where Case is available, only those XPs that do not require Case may move here. Thus, focus fronting may apply to PPs, but not to DPs, as we see in (27). In these examples, the focus fronting structure is evidenced by the post-focus cliticization of the pronoun *ko* (underlined) and the lack of nominative marking on the presuppositional statement (i.e., *bibilhin ...*); recall Section 4.2.

(26) Bi~bilh-in ko ang harina sa supermarket.

FUT~buy-PV 1SG.GEN NOM flour OBL supermarket

'I'm going to buy the flour at the supermarket.'

Baseline sentence

(27) DPs CANNOT OCCUPY SPEC-FOC P

a. *[Ang harina]_i ko bi~bilh-in *t_i* sa supermarket.

NOM flour 1SG.GEN FUT~buy-PV OBL supermarket

Intended: 'It's the flour that I'm going to buy at the supermarket.'

*DP focus fronting

b. [Sa supermarket]_i ko bi~bilh-in ang harina *t_i*.

OBL supermarket 1SG.GEN FUT~buy-PV NOM flour

'It's at the supermarket that I'm going to buy the flour.'

✓PP focus fronting

Because DPs cannot occupy Spec-FocP, a different strategy must be used to form focus constructions. This strategy is the periphrastic pseudocleft construction, which I have analyzed here as a DP-DP

specificational copular clause whose syntactic predicate is the focus constituent, and whose syntactic subject is the presuppositional statement contained in a (headless) relative clause. (28) gives an example, where the pseudocleft structure is evidenced by the post-verbal cliticization of the pronoun and the presence of nominative marking on the presuppositional statement (both underlined). We also see that an overt relative clause head is optionally possible as well. As discussed above, this structure is in fact a more general type of clause available in the language, as evidenced by the possibility of DP-DP clauses that do *not* involve relative clauses; recall (10-15).

(28) DP FOCUS TAKES THE FORM OF A PSEUDOCLEFT

[_{Pred} Ang harina] [_{Subj} ang (sangkap na) bi~bilh-in ko sa supermarket].
 NOM flour NOM ingredient LK FUT~buy-PV 1SG.GEN OBL supermarket

‘{What/The ingredient that} I’m going to buy at the supermarket is the flour.’ DP pseudocleft

Finally, it is also worth discussing the behavior of non-DPs with the pseudocleft construction. As discussed in detail in Chapter 4, pseudoclefts cannot be used to focus non-DPs. More specifically, it is not possible to straightforwardly switch the positions of the PP *sa supermarket* and the focus DP in (28), as (29) shows.

(29) *{Sa /Ang} supermarket [_{Subj} ang (lugar na) bi~bilh-in ko ang harina].
 OBL NOM supermarket NOM place LK FUT~buy-PV 1SG.GEN NOM flour

Intended: ‘(The place) Where I’m going to buy the flour is at the supermarket.’

*PP-targeted “pseudocleft”

The ill-formedness of examples like (29) can be understood once we consider a number of factors. First, non-DPs (especially PPs) exhibit slightly different behavior from other types of phrases (such as NPs) when in predicate position. For example, we saw in Section 4.2.2 that bare PP predicates take on a particular type of denotation that is more restricted than what we find with oblique PPs in non-predicate positions, often conveying possession or a goal as in (30). We also saw that PPs must be marked with a prefix *na-* to function as plain locative predicates, as in (31).

(30) a. **Sa bata** ang bulaklak na iyan.
 OBL child NOM flower LK DIST

‘That flower *is* the child’s.’

b. **Sa supermarket** ang punta nila.
 OBL supermarket NOM go 3PL.GEN

‘Their going *is* to the supermarket.’

(31) a. **Na-sa bata** ang bulaklak na iyan.
 PRED-OBL child NOM flower LK DIST

‘That flower *is with* the child.’

b. **Na-sa supermarket** ang pu~puntah-an nila.
 OBL supermarket NOM FUT~go-LV 3PL.GEN

‘Where they’re going *is in* the supermarket.’

Second, we have also seen that linker RC targeting non-DPs, such as the constituent labeled Subj in (29), are generally ill-formed. In the next section, I propose that the formation of linker RCs involves binding of a null pronoun *pro*. Assuming that *pro* is of category D, then we do not expect it to be able to appear in positions normally occupied by PPs or other non-DP elements. There is thus no way to have the correct kind of pseudocleft subject for the intended focus construction, at least not with linker RCs.

Interestingly, once we take these two factors into account, it becomes possible to find constructions

that are, in a sense, pseudoclefts that target non-DPs. (32) shows an example of this, where a *kung*-RC (instead of an ill-formed linker RC) appears in the subject position and a DP (instead of a PP) appears in the clause-initial predicate position. Examples such as this provide further evidence that the DP-DP clause structure is in fact rather general, and consequently that the pseudocleft strategy, used for focusing DPs, is periphrastic rather than a dedicated construction for this purpose.

- (32) Ang supermarket [Subj ang lugar **kung saan** bi~bill-in ko ang harina].
 NOM supermarket NOM place if where FUT~buy-PV 1SG.GEN NOM flour
 ‘The place where I’m going to buy the flour is the supermarket.’ ✓“Pseudocleft” with *kung*-RC

On a broad conceptual level, the proposal developed here is parallel to (and in fact draws a lot from) the analyses of Aldridge (2002) and Mercado (2004) with regards to capturing the structural differences between pseudoclefts and focus fronting. All three analyses propose a pseudocleft analysis of DP focus (i.e., a copular clause structure composed of a referential DP predicate and a relative clause subject) as well as a more conventional A' -movement approach for deriving focus fronting, differing mostly in terms of specific formal assumptions. The incremental but crucial improvement contributed by the present analysis, then, is the principled explanation for the distributional split between these two constructions. While these previous analyses discuss this issue of distributional split, the proposed accounts essentially boil down to assuming different starting points for either focus construction. That is, they simply assume that (i) DP focus necessarily involves the derivation of a DP-targeted relative clause as a prerequisite step to arrive at a structure similar to (23); and (ii) non-DP focus involves A' -movement of the focus constituent out of a “plain” clause parallel to what (25b) shows. I do not discuss these analyses in detail, as such a discussion would mostly involve recasting the structures proposed here into conceptually equivalent structures but with slightly different formal assumptions. That said, it should be clear that without explaining why the two focus constructions have these distinct derivational starting points, the problem of ruling out DP focus fronting pointed out at the outset of this subsection remains for these previous analyses. In other words, both Aldridge’s and Mercado’s analyses incorrectly predict that their equivalents of the derivation in (24b) should be grammatical.⁵ As I have shown, the present proposal avoids this prediction by positing that movement of DPs to the focus position is blocked because they would not have a value of abstract Case in their landing site.⁶

Having discussed the pseudocleft structure of DP pseudoclefts in detail, let us now turn to an important building block for deriving such structures: the linker RC which appears in subject position. These are discussed in the remainder of this chapter, beginning with Section 5.3, which presents the basic components of an analysis of relative clauses that does not rely on traditional A' -movement.

⁵More specifically, it is Mercado’s (2004) proposal that predicts exactly this, while my understanding of Aldridge’s (2002) analysis is that it predicts a derivation equivalent to (24b) to be possible only for non-pivot DPs.

⁶A question can be raised here about the status of hanging topics, such as *ang nais ko* ‘my wish’ in (i), and similar constructions with respect to Case licensing under this view. We might account for the acceptability of such constructions by positing that such “high-generated” DPs do not need abstract Case licensing, in contrast to those generated lower in the structure (e.g., within vP). The presence of morphological *ang*-marking could then be treated as an instance of default *morphological* Case, which surfaces in the absence of an *abstract* Case value. One piece of evidence that *ang* is indeed a morphological default (in addition to the spell-out of abstract nominative Case) comes from the fact that it is the citation form for DPs (including pronouns and proper names) in isolation.

(i) **Ang nais ko**, ma-lusog ang mama ko.
 NOM wish 1SG.GEN ADJ-healthy NOM mom 1SG.GEN
 ‘My wish (is that), my mom is healthy.’

5.3 DP relativization with *pro*

Following the observed patterns of focus constructions discussed in the previous sections, I pursue the idea that Tagalog also does not utilize standard A'-movement to form relative clauses of DPs. Such a view follows from the idea developed in the previous section, that abstract Case on DPs is not preserved under movement in Tagalog. Assuming, then, that the landing site of relative pronouns is like the landing site of focus fronting in lacking abstract Case, we expect that DP relative pronouns should be unable to undergo A'-movement in the expected fashion.

Following this, I propose that the language uses a null pronoun, *pro*, which introduces a free variable of type *e* that is subsequently bound by an operator introduced at the periphery of the clause. Similar accounts have been proposed in other languages for relative clauses (e.g., McCloskey 2002, Irish) as well as other functionally similar individual-denoting nominalizations containing some degree of clause(-like) structure (e.g., Bliss 2014, Blackfoot; Salanova 2011, Mëbengokre; Toosarvandani 2014, Northern Paiute). However, a key difference lies in how the distribution of the null pronoun *pro* is restricted. I claim that the binding of *pro* is subject to a locality requirement such that (under most circumstances), *pro* must escape the thematic domain (i.e., *vP*) in order for binding to be established. I further claim that satisfaction of this locality requirement is fed by independent processes in the language. Here, we will see that pivot movement to Spec-AgrP is one such process, resulting in the behavior conforming to the pivot-only generalization.

Ultimately, I am unable to provide a concrete formalization of this locality requirement, so its use in this chapter may seem ad hoc. However in Chapter 6, I argue that this locality requirement can be observed in the behavior of DP A'-dependencies that violate the pivot-only restriction, but are nevertheless acceptable. We will see that binding may be fed not only by pivot movement, but also by at least one other independently available movement process as well as by reduced structure. In this regard, the claimed locality requirement constitutes a fairly robust generalization about the behavior of *pro*, for which potential formalizations are also discussed in Chapter 6.

Furthermore, this *pro*-based mechanism stands in contrast to A'-movement (which I propose is responsible for non-DP dependencies). The presence of both as distinct mechanisms for A'-dependency formation allows us to straightforwardly understand the different locality signatures we observe in Tagalog between DP- and non-DP dependencies. In particular, we find environments in Tagalog out of which only DP dependencies can be formed (Secs. 5.6.2 and 6.4.5), as well as environments where only non-DP dependencies may be formed (Sec. 7.1).

Having said this, the remainder of this chapter will be focused on presenting the basic aspects of the *pro*-based account of relative clauses as they relate to behavior that conforms to the pivot-only generalization. I show in this section and the next that this account correctly derives local (i.e., monoclausal) as well as long-distance linker relative clause, particularly accounting for some specific behavior exhibited by the latter type of construction.

5.3.1 Theme relative clauses

I illustrate the proposal with a simple theme relative clause example, like the one in (33). I assume that the selectional behavior of the null pronoun *pro* is just like any other pronoun in that it can merge with anything that selects a DP. For a theme relative clause, this would mean base-generation in thematic object position, complement of V^0 . Let us also assume for this first example that the feature [PIVOT] appears on *pro*. Recall that I assume that the distribution of [PIVOT] is, from the point of view of syntax, free among DPs. After merging the external argument, we have the structure in (34).

- (33) ang (kape=ng) i~inum-in ni Gina
 NOM coffee=LK FUT~drink-PV GEN.P Gina
 ‘the {coffee/one} that Gina will drink’

- (34) STRUCTURE AFTER MERGING EXTERNAL ARGUMENT (THEME RC)

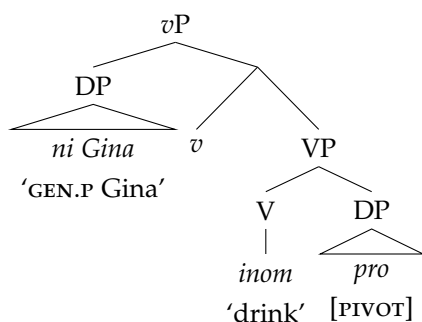

Next, Agr^0 is merged. Recall from Section 3.2 that I assume that Agr^0 probes its c-command domain for a DP bearing [PIVOT], triggering it to move to Spec-AgrP and assigning it nominative Case. This is shown in (35), and further results in Agr^0 being spelled-out as PV *-in*. Later in this section, we will see what happens if *pro* does not undergo pivot movement.

- (35) AGR^0 AGREES WITH THEME (THEME RC)

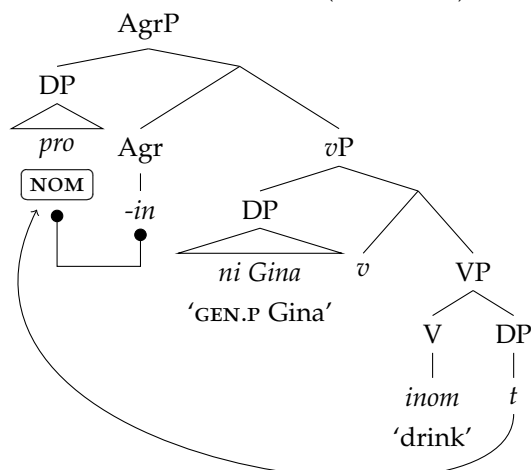

Finally, the phase head C^0 triggers the introduction of a null operator (represented as λ_x) co-indexed to *pro* above IP, as in (36).⁷ To simplify the tree, I have not shown the head movement from V^0 to

⁷An alternative to the high generation of the λ -operator that is left for future exploration is to have *pro* move to a similarly high

I^0 that I assume to derive the verb-initial word order in this language (following Massam and Smallwood 1997; Massam 2000). A semantic derivation is given in (37), showing that the resulting construction is a predicate of individuals (type $\langle e, t \rangle$).

(36) INTRODUCTION OF LAMBDA-OPERATOR (THEME RC)

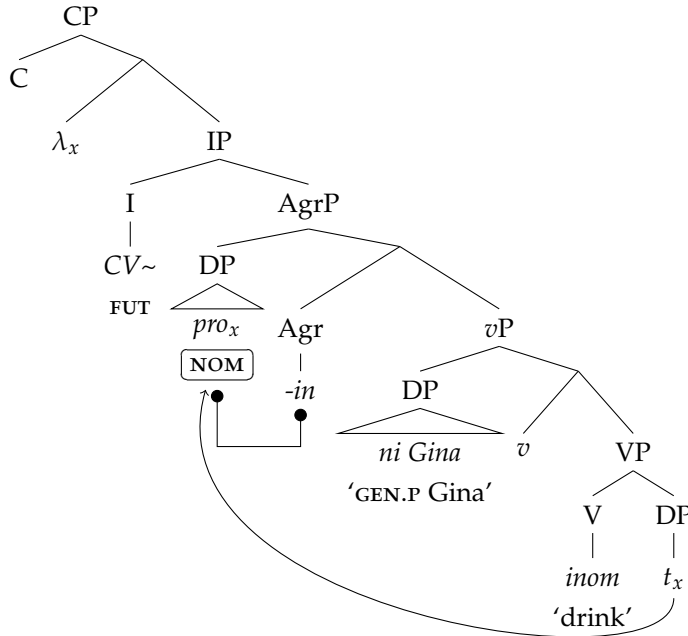

I assume a Davidsonian semantics following Kratzer (1996), in particular I assume that external arguments are introduced separately in the semantic derivation by a function agent and the semantic composition principle called Event Identification. The symbol v represents the semantic type corresponding to events. I also assume that Agr^0 is semantically vacuous, and use simplified semantic denotations for tense/aspect, assuming that this information is introduced by I^0 .

(37) SEMANTIC DERIVATION (THEME RC)

- a. $\llbracket \text{VP} \rrbracket = \lambda e [\text{drink}(x)(e)]^8$ $\langle v, t \rangle$
- b. $\llbracket v \rrbracket = \lambda y [\lambda e [\text{agent}(y)(e)]]$ $\langle e, vt \rangle$
- c. $\llbracket v' \rrbracket = \lambda y [\lambda e [\text{drink}(x)(e) \wedge \text{agent}(y)(e)]]$ $\langle e, vt \rangle$
- (by Event Identification)
- d. $\llbracket \text{ni Gina} \rrbracket = g$ e
- e. $\llbracket vP \rrbracket = \lambda e [\text{drink}(x)(e) \wedge \text{agent}(g)(e)]$ $\langle v, t \rangle$

position in the clause. A potential advantage of this alternative is that *pro* can be tied to the contrastive/emphatic *siyang*, described in Section 4.2.4, that appears in the periphery of linker RCs. The particular interpretative effect of *siyang* could also potentially be likened to the contrastive nature of overt pronouns in pro-drop languages of the Spanish type. However, this alternative has strong parallels to more standard A' -movement of a relative pronoun. Given the differences discussed in Chap. 7 between the *pro*-based mechanism and conventional A' -movement in Tagalog, pursuing the alternative outlined here would require ascertaining whether its parallels to A' -movement are superficial or indicate that a unified analysis should be pursued instead.

⁸Here, I am simplifying the presentation of how *inom* 'drink' composes with the trace of *pro*. I adopt the quantificational verbal semantics proposed by Collins (2019), which is presented in a less simplified form in (44) below. For traces to compose properly with verbs, Collins proposes that they undergo *ident*-shifting, going from a type e variable (x) to an object of type $\langle e, t \rangle$ ($\lambda x' [x' = x]$). The *ident*-shifted trace then composes with verb to result in the VP denotation given here.

- f. $\llbracket \text{AgrP} \rrbracket = (\lambda x \llbracket \text{vP} \rrbracket)(\llbracket \text{pro}_x \rrbracket) = \llbracket \text{vP} \rrbracket$
- g. $\llbracket \text{CV}\sim \rrbracket = \lambda P [\lambda e [P(e) \wedge \text{now} < \tau(e)]]$ $\langle vt, vt \rangle$
- h. $\llbracket \text{IP} \rrbracket = \lambda e [\text{drink}(x)(e) \wedge \text{agent}(g)(e) \wedge \text{now} < \tau(e)]$ $\langle v, t \rangle$
- i. $\llbracket \text{IP} \rrbracket = \exists e [\text{drink}(x)(e) \wedge \text{agent}(g)(e) \wedge \text{now} < \tau(e)]$ t
(by \exists -Closure of event var.)
- j. $\llbracket \text{CP} \rrbracket = \lambda x [\exists e [\text{drink}(x)(e) \wedge \text{agent}(g)(e) \wedge \text{now} < \tau(e)]]$ $\langle e, t \rangle$
(by Predicate Abstraction)

At this point, we have a CP that denotes a predicate of individuals (type $\langle e, t \rangle$).⁹ I assume that this CP may combine directly with a determiner to form a headless relative clause (38), or first combine with a head noun of type $\langle e, t \rangle$ before combining with a determiner to form a headed relative clause (39); only relevant projections are shown below.¹⁰ For concreteness, I assume that *ang* has the typical semantics of a definite determiner: $\llbracket \text{ang} \rrbracket = \lambda P [\iota x [P(x)]]$. Both possibilities result in individual-denoting expressions, with the latter option simply having the extra semantic restriction contributed by the nominal head.

(38) HEADLESS RELATIVE (THEME RC)

- a. *ang i~inum-in ni Gina*
 NOM FUT~drink-PV GEN.P Gina
 ‘{the one that/what} Gina will drink’
- b.
- ```

graph TD
 DP --> D[ang]
 DP --> CP
 CP --> Lambda["λ iinum-in ni Gina pro"]
 CP --> Gloss["that Gina will drink'"]

```
- c.  $\llbracket \text{DP} \rrbracket = \iota x [\exists e [\text{drink}(x)(e) \wedge \text{agent}(g)(e) \wedge \text{now} < \tau(e)]]$

<sup>9</sup>The full clausal structure adopted here contrasts with the nominalization approach adopted in some of the previous accounts mentioned (Bliss 2014; Salanova 2011; Toosarvandani 2014).

<sup>10</sup>Example (39) shows a head-initial relative clause, but I assume that the nominal head and relative clause modifier can combine in the opposite order to generate a head-final relative clause (i.e., *ang [iinum-in ni Gina] na [kape]*). It is not clear, however, how to derive head-internal relative clauses under this account. For more on the different word orders possible for Tagalog DP relative clauses, see Aldridge 2004b, 2017a; Law 2016.

## (39) HEADED RELATIVE (THEME RC)

- a. ang kape=*ng* i~inum-in ni Gina  
 NOM coffee=LK FUT~drink-PV GEN.P Gina  
 ‘the coffee that Gina will drink’

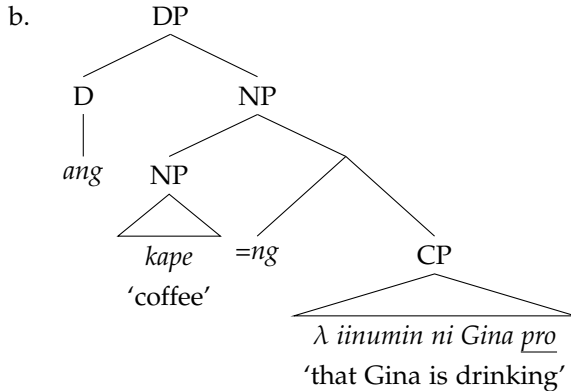

- c.  $\llbracket kape \rrbracket = \lambda x [\text{coffee}(x)]$   
 d.  $\llbracket DP \rrbracket = \iota x [\exists e [\text{coffee}(x) \wedge \text{drink}(x)(e) \wedge \text{agent}(g)(e) \wedge \text{now} < \tau(e)]]$

We have thus derived a voice-agreeing theme relative clause with the corresponding PV morphology on the verb by having  $\text{Agr}^0$  target *pro* for Agree (as mediated by [PIVOT]). Now I turn to another crucial ingredient in any analysis of Tagalog DP relatives, which is to show that it properly excludes voice-*disagreeing* relative clauses that are not attested. As I have mentioned previously, Tagalog *does* allow voice-*disagreeing* A'-dependencies, although only of certain types. These are discussed in detail in Chapter 6. The focus now will be to exclude the *ungrammatical* instances of such dependencies. I take the behavior of ungrammatical non-pivot theme dependencies to be representative.

Recall that I assume that the distribution of [PIVOT] is free (effectively allowing  $\text{Agr}^0$  to agree freely with DPs in its c-command domain). What would happen, then, if [PIVOT] appeared on a different DP such as the agent? In this situation, it is the agent that moves to Spec-AgrP and receives nominative Case, and  $\text{Agr}^0$  is spelled out as AV *m-*, as shown in (40). On the other hand, *pro* corresponding to the theme remains within *vP*. For now, I will simply claim that in this *vP*-internal position, *pro* cannot be bound by the clause-peripheral operator introduced above IP because it is not local enough. This accounts for the ill-formedness of theme relative clauses with AV clauses, as shown by the example in (41). As mentioned at the beginning of this section, I will show in Chapter 6 that this locality requirement is quite general and can be satisfied through means other than pivot-movement, which is what was shown here. These alternative means of satisfying the locality requirement allow for configurations where *pro* does not surface in Spec-AgrP (i.e., is not the pivot), thus generating the DP-targeting A'-dependencies that violate the pivot-only generalization on A'-dependency formation.

- (40) AGR
- <sup>0</sup>
- AGREES WITH EXTERNAL ARGUMENT (ATTEMPTED THEME RC)

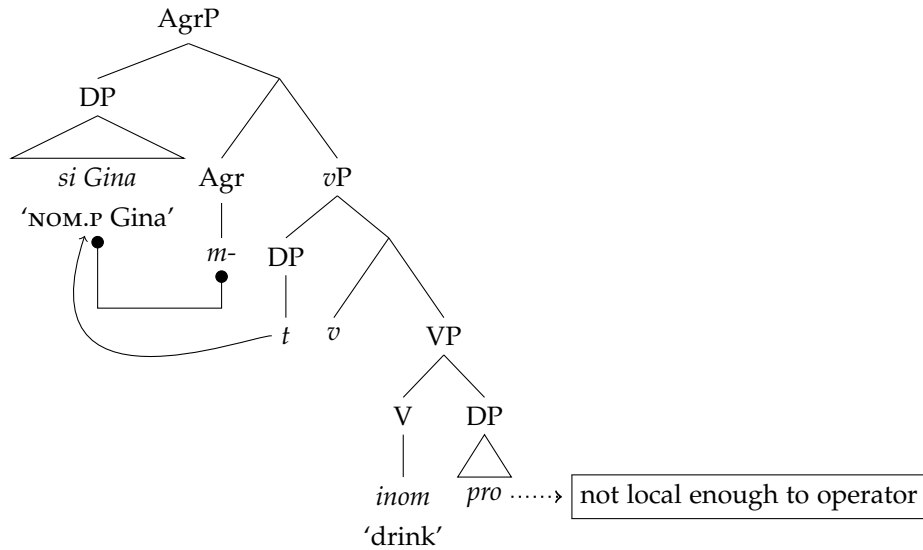

- (41) \*ang (kape=ng) i~inom si Gina  
 NOM coffee=LK FUT~drink[AV] NOM.P Gina  
 Intended: 'the {one/coffee} that Gina will drink'

### 5.3.2 Agent relative clauses

For agent relative clauses with AV morphology, we have a similar derivation, this time with *pro* generated in Spec-*vP*,  $v^0$  being the assumed external-argument-introducing head in this analysis. I adopt the semantics for Tagalog proposed by Collins (2019) which assigns inherently quantificational denotations for verb roots to derive the indefinite interpretation of non-pivot themes in this language. Thus, the root *luto* 'cook' has the denotation given in (44b).

- (42) ang (babae=ng) mag-lu~luto ng pinakbet  
 NOM woman=LK AV-FUT~cook GEN pinakbet  
 'the {woman/one} who will cook *pinakbet*'

## (43) AV RELATIVE CLAUSE DERIVATION

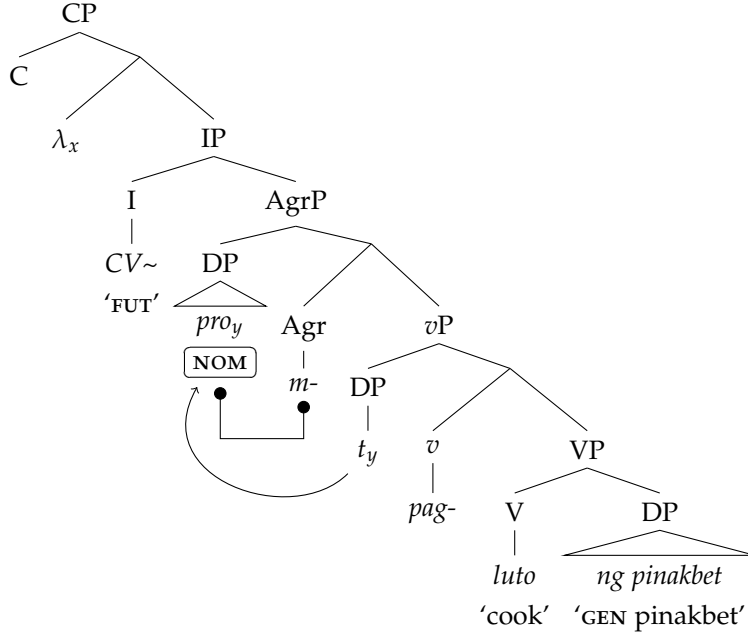

## (44) SEMANTIC DERIVATION (AGENT RC)

- a.  $\llbracket ng \text{ pinakbet} \rrbracket = \lambda x [\text{pinakbet}(x)]$   $\langle e, t \rangle$
- b.  $\llbracket luto \rrbracket = \lambda P [\lambda e [\exists x [P(x) \wedge \text{cook}(x)(e)]]]$   $\langle et, vt \rangle$
- c.  $\llbracket VP \rrbracket = \lambda e [\exists x [\text{pinakbet}(x) \wedge \text{cook}(x)(e)]]$   $\langle v, t \rangle$
- d.  $\llbracket pag- \rrbracket = \lambda y [\lambda e [\text{agent}(y)(e)]]$   $\langle e, vt \rangle$
- e.  $\llbracket v' \rrbracket = \lambda y [\lambda e [\exists x [\text{pinakbet}(x) \wedge \text{cook}(x)(e) \wedge \text{agent}(y)(e)]]]$   $\langle e, vt \rangle$
- (by Event Identification)
- f.  $\llbracket t_y \rrbracket = y$   $e$
- g.  $\llbracket vP \rrbracket = \lambda e [\exists x [\text{pinakbet}(x) \wedge \text{cook}(x)(e) \wedge \text{agent}(y)(e)]]$   $\langle v, t \rangle$
- h.  $\llbracket AgrP \rrbracket = (\lambda y [\llbracket vP \rrbracket])(\llbracket pro_y \rrbracket) = \llbracket vP \rrbracket$
- i.  $\llbracket CV\sim \rrbracket = \lambda P [\lambda e [P(e) \wedge \text{now} < \tau(e)]]$   $\langle vt, vt \rangle$
- j.  $\llbracket IP \rrbracket = \lambda e [\exists x [\text{pinakbet}(x) \wedge \text{cook}(x)(e) \wedge \text{agent}(y)(e) \wedge \text{now} < \tau(e)]]]$   $\langle v, t \rangle$
- k.  $\llbracket IP \rrbracket = \exists e [\exists x [\text{pinakbet}(x) \wedge \text{cook}(x)(e) \wedge \text{agent}(y)(e) \wedge \text{now} < \tau(e)]]]$   $t$
- ( $\exists$ -Closure of event var.)
- l.  $\llbracket CP \rrbracket = \lambda y [\exists e [\exists x [\text{pinakbet}(x) \wedge \text{cook}(x)(e) \wedge \text{agent}(y)(e) \wedge \text{now} < \tau(e)]]]]]$   $\langle e, t \rangle$
- (Predicate Abstraction)
- m.  $\llbracket CP \rrbracket = \lambda y [\exists e [\text{agent}(y)(e) \wedge \text{cook}(x)(e) \wedge \text{pinakbet}(x) \wedge \text{now} < \tau(e)]]]$

Having discussed local dependencies, I now turn to long-distance dependencies, and discuss how these can be derived under the analysis proposed here.



## 5.4 Long-distance relativization

Within the literature on Tagalog, it is well-known that the voice system interacts not only with local dependency formation, but with long-distance dependency formation as well (see e.g., Aldridge 2009; Kaufman 2011; Rackowski and Richards 2005; Richards 2009a). In fact, similar behavior has been reported for related languages, including Chamorro (Chung 1982), Madurese (Davies 2003), Malagasy (Pearson 2005), Malay (Cole and Hermon 1998), and Palauan (Chung and Georgopoulos 1988) to name a few. This interaction takes the form of a restriction whereby higher verbs crossed by such dependencies must appear in a particular voice form, resulting in apparently successive-cyclic behavior. In this section, I provide a summary of this interaction (limiting the discussion to DP dependencies) and then show how the *pro*-binding analysis developed here for local dependencies can be applied to account for this behavior through a kind of successive-cyclic binding.

### 5.4.1 Voice and long-distance dependencies

We have seen so far that with local A'-dependencies of DPs, the main verb of the clause must appear in a form that would have marked the argument corresponding to the gap nominative. We see this behavior for relativization in (45): with a verb marked AV, such as *nagnakaw* 'stole (AV)', the agent can be relativized but the theme cannot.

(45) VOICE AND LOCAL EXTRACTION

- a. Nag-nakaw ang duwende ng agimat.  
 AV.PFV-steal NOM dwarf GEN talisman  
 'The dwarf stole a talisman.' Baseline
- b. duwende=ng nag-nakaw ng agimat  
 dwarf=LK AV.PFV-steal GEN talisman  
 'dwarf that stole a talisman' ✓AV Agent RC
- c. \*agimat na nag-nakaw ang duwende  
 talisman LK AV.PFV-steal NOM dwarf  
 Intended: 'talisman that the dwarf stole' \*AV Theme RC

Similar behaviors are also known to exist in Tagalog long-distance dependencies (see e.g., Aldridge 2009; Kaufman 2011; Rackowski and Richards 2005; Richards 2009a). In these environments, voice restrictions affect the verb not only in the minimal clause containing the dependency gap, but also in all higher clauses up to the edge of the dependency. Whereas the form of the lowest verb is predicted by the thematic role of the relativized argument, the voice forms of the higher verbs must correspond, in some sense, to the complement clause. To facilitate this discussion, I will refer to this behavior as the Matrix Verb Constraint (MVC), summarized in (46).

## (46) MATRIX VERB CONSTRAINT

Higher verbs crossed by a long-distance (DP) A'-dependency must appear in the voice form that designates the clause containing the dependency gap as the pivot.

Let us consider the concrete examples in (47) to illustrate the MVC, which show (attempted) relativization of the theme argument out of an embedded clause. The four example sentences represent all logically possible ways to combine two forms of the embedded verb *huli* 'catch' (PV *hinuli* and AV *humuli/nanghuli*) with two forms of the matrix verb *panaginip* 'dream' (LV *napanaginipan* and AV *nanaginip*).<sup>11</sup> Among these, only (47a) is grammatical. Comparing this with the other three ungrammatical examples shows us that both the matrix and the embedded verb in a long-distance dependency must appear in a specific verb form.

We see familiar behavior when we compare the minimal pair of (47a) and (47b) differing only in the voice specification of the embedded verb. This pair shows us that the embedded verb must appear in the PV form, which is expected because relativization targets the theme of this clause. Wavy underlining in (47b) is provided to highlight that the embedded verb form (i.e., AV) is causing ungrammaticality. Additionally, we also see that the form of the matrix verb is constrained. This time, consider the minimal pair (47a) and (47c) differing only in the voice specification of the matrix verb. This pair shows clearly that the matrix verb must appear in the LV form *napanaginipan* and not the AV form *nanaginip*. In particular, notice that (47c) is ungrammatical despite the embedded verb being in the correct voice form (i.e., PV). Again, wavy underlining highlights the offending (matrix) verb form in this example. For completeness, (47d) shows that relativization is also ungrammatical if both matrix and embedded verbs appear in the wrong form.

(47) VOICE RESTRICTIONS IN LONG-DISTANCE DEPENDENCIES<sup>12</sup>

- a. duwende=ng [na-panaginip-an<sub>i</sub> ko=ng <sub>i</sub>[<sub>CP</sub> h<in>uli-Ø<sub>k</sub> ni Diego *pro*<sub>k</sub>]]  
 dwarf=LK PFV.NVOL-dream-LV 1SG.GEN=LK <PFV>catch-PV GEN.P Diego  
 'dwarf that I dreamt that Diego caught'
- b. \*duwende=ng [na-panaginip-an<sub>i</sub> ko=ng <sub>i</sub>[<sub>CP</sub> h<um>uli /nang-huli]<sub>k</sub> si Diego<sub>k</sub> *pro*]]  
 dwarf=LK PFV.NVOL-dream-LV 1SG.GEN=LK <AV>catch(PFV) AV.PFV-catch NOM.P Diego  
 Intended: 'dwarf that I dreamt that Diego caught' Embedded verb mismatch
- c. \*duwende=ng [n-anaginip<sub>i</sub> ako<sub>i</sub>=ng [<sub>CP</sub> h<in>uli-Ø<sub>k</sub> ni Diego *pro*<sub>k</sub>]]  
 dwarf=LK AV.PFV-dream 1SG.NOM=LK <PFV>catch-PV GEN.P Diego  
 Intended: 'dwarf that I dreamt that Diego caught' Matrix verb mismatch

<sup>11</sup>As a minor morphological aside, the behavior of *panaginip* suggests that it bears the prefix *paN-*. However, any potential root no longer seems to be independently attested as a free morpheme in the language. For example, the UP Filipino Dictionary (Almario 2010) does not provide a morphological decomposition for this lexical item. There are a handful of these verbs in Tagalog, another example being *pangarap* 'aspire, aspiration'.

<sup>12</sup>The AV and LV forms of *panaginip* in these examples also differ in whether they appear in the neutral form (AV *nanaginip*; see (52) below for a grammatical example) or the non-volitional form (LV *napanaginipan*). It just so happens that these forms are the most natural ones used when talking about dreaming. The neutral LV form *panaginipan* gives the impression that the matrix external argument somehow has intentional control over their dreaming. The non-volitional AV form *makapanaginip* gives the impression that the matrix external argument somehow overcame some obstacle to have the dream. Other embedding verbs exist which differ only in voice and not with this neutral/non-volitional distinction, but they introduce other confounds (see fn.14).

- d. \*duwende=ng [n-anaginip<sub>i</sub> ako<sub>i</sub>=ng [CP{h<um>uli /nang-huli}<sub>k</sub> si Diego<sub>k</sub> *pro*]  
 dwarf=LK AV.PFV-dream 1SG.NOM=LK <AV>catch(PFV) AV.PFV-catch NOM.P Diego

Intended: 'dwarf that I dreamt that Diego caught'

Both verbs mismatch

As previously mentioned, we can straightforwardly understand why the embedded verb in (47) must appear in PV, as it is the theme of this verb that is targeted for relativization. On the other hand, we can understand how the form of the matrix verb is constrained via the MVC stated in (46). To see how this works, let us consider more closely matrix clause argument marking patterns in (47). In the examples with the AV matrix verb *nanaginip*, which we have seen is incompatible with the long-distance dependency, the matrix agent *ako* 'I' is the argument designated the pivot, as evidenced by the nominative form of the pronoun. On the other hand, in the examples with the compatible form of the matrix verb, LV *napanaginipan*, no argument in the matrix clause is overtly nominative-marked. We can take this fact to indicate that the effective pivot in such cases is the embedded clause (Aldridge 2009; Rackowski and Richards 2005; Richards 2009a), with the absence of nominative marking on the clause explained as a result of a general incompatibility between CPs and (morphological) case. Such a view is corroborated by the fact nominative marking *is* overt when the complement of a verb like *napanaginipan* is a DP instead of a CP, as (48) shows.<sup>13</sup>

- (48) Na-panaginip-an ko {si Diego/ang duwende/iyon }.  
 PFV.NVOL-dream-LV 1SG.GEN NOM.P Diego NOM dwarf DIST.NOM

'I dreamt [about Diego / about the dwarf / (about) that].'

Thus, the LV form of the matrix verb in (47) is the one that designates the embedded clause as the pivot, it is the one that conforms to the MVC. To drive the point home, (49) provides schematic representations of the examples in (47), where the pivots of the embedded and matrix clauses are boxed. These show that a grammatical long-distance dependency requires that the dependency gap (*pro*) is the pivot of its clause, and that any containing clauses are the pivots of *their* clauses.

- (49) SCHEMATIC REPRESENTATION OF (47)

- a. ✓ [CP V DP ... [CP V DP pro ... ] ]  
 b. \* [CP V DP ... [CP V DP *pro* ... ] ]  
 c. \* [CP V DP ... [CP V DP pro ... ] ]  
 d. \* [CP V DP ... [CP V DP *pro* ... ] ]

Note that the schematics in (49) do not specify a specific voice form for the matrix verb, as this varies with the matrix verb. For example, we see in (50-51) that the voice forms of *sabi* 'say' and *pangako* 'promise' that conform to the MVC are the PV and CV forms, respectively.

<sup>13</sup>The fact that we have an LV form and not a PV form reflects the fact discussed in Sec. 3.1 that Tagalog voice morphology does not necessarily map to thematic role of the pivot in a totally direct way, and is affected by a number of factors including lexical properties of the root. For *panaginip* 'dream', the form used to designate the verbal complement as the pivot is LV (i.e., the one bearing the LV suffix *-an*). In fact, *panaginip* 'dream' does not have a PV form (i.e., one bearing the PV suffix *-in* in the neutral aspect).

- (50) a. kalabaw na [**s<in>abi** ng guro na [bi~bigy-an ng laláki ng bulaklak *pro*]]  
 water.buffalo LK <PFV>say[PV] GEN teacher LK FUT~give-LV GEN man GEN flower  
 ‘water buffalo [that the teacher said [that the man would give a flower to]]’  
 (Rackowski and Richards 2005, ex.51a)
- b. \*kalabaw na [**nag-sabi** ang guro na [bi~bigy-an ng laláki ng bulaklak *pro*]]  
 water.buffalo LK AV.PFV-say GEN teacher LK FUT~give-LV GEN man GEN flower  
 Intended: ‘water buffalo [that the teacher said [that the man would give a flower to]]’
- (51) a. kalabaw na [**i-p<in>angako** ng guro na [bi~bigy-an ng laláki ng bulaklak *pro*]]  
 water.buffalo LK CV-<PFV>promise GEN teacher LK FUT~give-LV GEN man GEN flower  
 ‘water buffalo [that the teacher promised [that the man would give a flower to]]’  
 (Rackowski and Richards 2005, ex.51b)
- b. \*kalabaw na [**n-angako** ang guro na [bi~bigy-an ng laláki ng bulaklak *pro*]]  
 water.buffalo LK AV.PFV-promise GEN teacher LK FUT~give-LV GEN man GEN flower  
 Intended: ‘water buffalo [that the teacher promised [that the man would give a flower to]]’

We also know that the restriction on matrix verb voice shown in (47) is due to the dependency, as outside of  $A'$ -dependency contexts, voice on both the matrix and embedded verbs is free.<sup>14</sup> This freedom is shown for the matrix verb in (52). Furthermore, (53) shows that the AV form is also used when forming a relative clause over the matrix agent position, as expected. In other words, the ill-formedness of (47c) and (47d), which have the AV form *nanaginip* as their matrix verb, is not simply due to the verb itself being ill-formed or unattested.

- (52) VOICE ON EMBEDDING VERBS IS NOT RESTRICTED IN DECLARATIVE CONTEXTS
- a. Na-panaginip-**an**<sub>i</sub> ko=ng [<sub>CP</sub> h<in>uli- $\emptyset$ <sub>k</sub> ni Diego ang duwende<sub>k</sub>].  
 PFV.NVOL-dream-LV 1SG.GEN=LK <PFV>catch-PV GEN.P Diego NOM dwarf  
 ‘I dreamt that Diego caught the dwarf.’
- b. N-anaginip<sub>i</sub> ako<sub>i</sub>=ng [<sub>CP</sub> h<in>uli- $\emptyset$ <sub>k</sub> ni Diego ang duwende<sub>k</sub>].  
 AV.PFV-dream 1SG.NOM=LK <PFV>catch-PV GEN.P Diego NOM dwarf  
 ‘I dreamt that Diego caught the dwarf.’
- (53) MATRIX AGENT RC WITH AV FORM *managinip*  
 bata=ng n-anaginip na [<sub>CP</sub> h<in>uli- $\emptyset$  ni Diego ang duwende]]  
 child=LK AV.PFV-dream LK <PFV>catch-PV GEN.P Diego NOM dwarf  
 ‘child who dreamt that Diego caught the dwarf’

Thus, we see that verbs that select CPs display similar voice alternations to those that do not, and that these voice alternations are subject to restrictions in long-distance dependencies in ways that

<sup>14</sup> Although note that there are verbs for which at least one voice form, usually AV, is highly marked when used in plain declarative clauses. For example, with *sabi* ‘say’ in (50), the AV form *magsabi* is generally only used with  $A'$ -dependencies targeting its agent (i.e., the sayer). Otherwise, the PV form *sabihin* is more natural.

are parallel to what we see with other verbs in local dependencies. The crucial difference is that such restrictions are not directly linked to the target of the dependency, but to the clause containing the target. Having shown that the voice restriction in Tagalog manifests in contexts outside of local A'-dependencies, the goal of this section is to extend the analysis for local dependencies presented in the previous section to account for the long-distance facts we have just seen. I present the analysis in the remainder of this section, and discuss it in the context of previous proposals in Section 5.6.

### 5.4.2 Assumptions for declarative embeddings

To set the stage for the analysis, I first lay out my assumptions as to how declarative embedded clauses are composed when no A'-dependency is involved. I assume that embedded declarative clauses are simply base-generated as the complement of a CP-selecting  $V^0$ . Semantically, the denotations of these verbs are of type  $\langle st, vt \rangle$ , having as their domain objects of propositional semantic type  $\langle \langle s, t \rangle \rangle$ . The syntax for this is shown in (54), with a semantic derivation given in (55).

(54) V + COMPLEMENT CLAUSE (NO GAP)

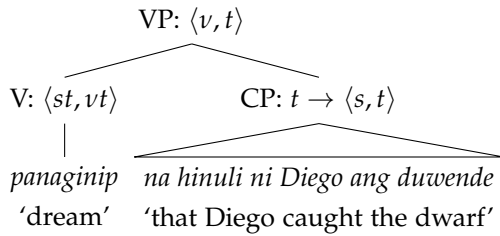

(55) SEMANTIC DERIVATION

- a.  $\llbracket \text{CP} \rrbracket^w = \exists e [\text{catch}_w(\text{dwarf})(e) \wedge \text{agent}(\text{Diego})(e) \wedge \tau(e) < \text{now}] \quad t$
- b.  $\llbracket \text{panaginip} \rrbracket^w = \lambda p [\lambda e [\forall v \in W [\text{dream}_w(e)(v) = 1 \rightarrow p(v) = 1]]] \quad \langle st, vt \rangle$   
 where  $\text{dream}_w = \lambda e_v [\lambda v_s [e \text{ is an event of dreaming in world } w \wedge$   
 $v \text{ is a possible world compatible with the contents of } e]]$
- c.  $\llbracket \text{VP} \rrbracket^w = \lambda e [\forall v \in W [\text{dream}_w(e)(v) = 1 \rightarrow$   
 $\exists e' [\text{catch}_v(\text{dwarf})(e') \wedge \text{agent}(\text{Diego})(e') \wedge \tau(e') < \text{now}]]] \quad \langle v, t \rangle$   
 (by Intensional Func. Appl.)

The result at the VP level is a predicate of events. This predicate holds for an event  $e$  if  $e$  is an event of dreaming such that for all possible worlds  $v$  that are compatible with what happens in  $e$  (dream worlds), there is a past event of catching of the salient dwarf by Diego in the dream world  $v$ .

With a basic structure for clausal complementation laid out, we can now turn to the analysis of DP-targeted long-distance dependencies.

### 5.4.3 Long-distance dependencies via *pro* as a repair

An adequate account of long-distance A'-dependencies of DPs in Tagalog requires not only that the correct semantics are predicted with regards to clausal embedding, but also that the MVC is correctly derived, as we saw at the beginning of this section. I show here that the *pro*-binding approach to relativization can be applied to the problem of long-distance dependencies to fulfill these two requirements. In particular, I claim that the MVC stems from a semantic type clash at the point of clausal complementation that is resolved through syntactic means.

I assume the derivation of a long-distance A'-dependency starts out with the same syntactic configuration for embedded declarative CPs shown in (54), where  $V^0$  selects a complement CP. The key difference in this case is that the complement CP contains an instance of *pro*, naturally corresponding to the dependency gap. Following the proposal in Section 5.3, I assume that the presence of *pro* triggers the insertion of an operator above IP once the phase head  $C^0$  enters the derivation. For our example, this means that the complement CP in (56) has the structure of a theme relative clause like (36) and a denotation of type  $\langle e, t \rangle$ . I assume that this structure is well-formed syntactically, but introduces a semantic type mismatch, as illustrated in (56). Specifically,  $\llbracket V \rrbracket$  and  $\llbracket CP \rrbracket$  have no way to compose semantically (e.g., by Functional Application or Intensional Functional Application).<sup>15</sup>

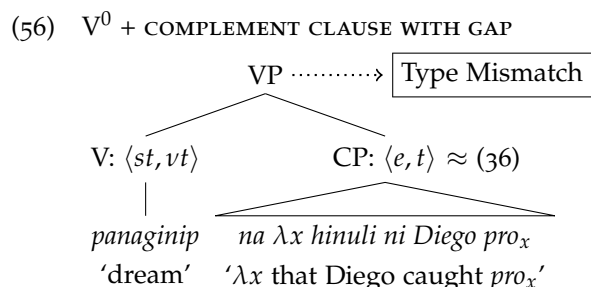

Here, there is a salient question regarding the mismatch is worth briefly pointing out. In (56), the conflicting types of  $\llbracket V \rrbracket$  and  $\llbracket CP \rrbracket$  can ultimately be tied to the presence of  $\lambda x$ , which results in the higher type of  $\langle e, t \rangle$  rather than the more typical type  $t$  for declarative CPs, as discussed in Section 5.4.2. The question is then if we can avoid the type mismatch altogether by simply assuming that  $\lambda x$  is absent in such constructions. I claim that the presence of the  $\lambda$ -operator results from the locality requirement on binding, which I claimed to be tied to the need for *pro* to escape *vP* in local dependencies (Sec. 5.3). That is,  $\lambda x$  is necessary because higher operators will be insufficiently local to  $pro_x$  in (the embedded) Spec-AgrP, and  $pro_x$  has no way to further move to a higher position. I will discuss this in detail later in Sections 5.5–5.6.

Given that the  $\lambda$ -operator must appear in the derivation, the type mismatch must be resolved. I propose that Tagalog does this by inserting another instance of *pro*. This second *pro* saturates the individual argument slot of the CP modifier, resulting in the correct semantic type ( $t$ ) to compose with  $V^0$  via Intensional Function Application.<sup>16</sup> The partial derivation is illustrated in (57–58).

<sup>15</sup>The presence of the  $\lambda$ -operator in the denotation of the embedded clause is crucial for generating the semantic type clash. I discuss the implications of this requirement in the next sections.

<sup>16</sup>There is potentially a question here regarding timing. The semantic type mismatch is presumably only relevant at the point where  $V^0$  with CP compose semantically. Assuming a cyclic derivation where semantic composition occurs only at the spell-out of a phase, this problematic composition would only occur at the spell-out of the higher phase. However, the higher instance of *pro* must be present in the structure at an earlier point in the derivation for Agr<sup>0</sup> to target it for Agree. I leave this issue open in this thesis.

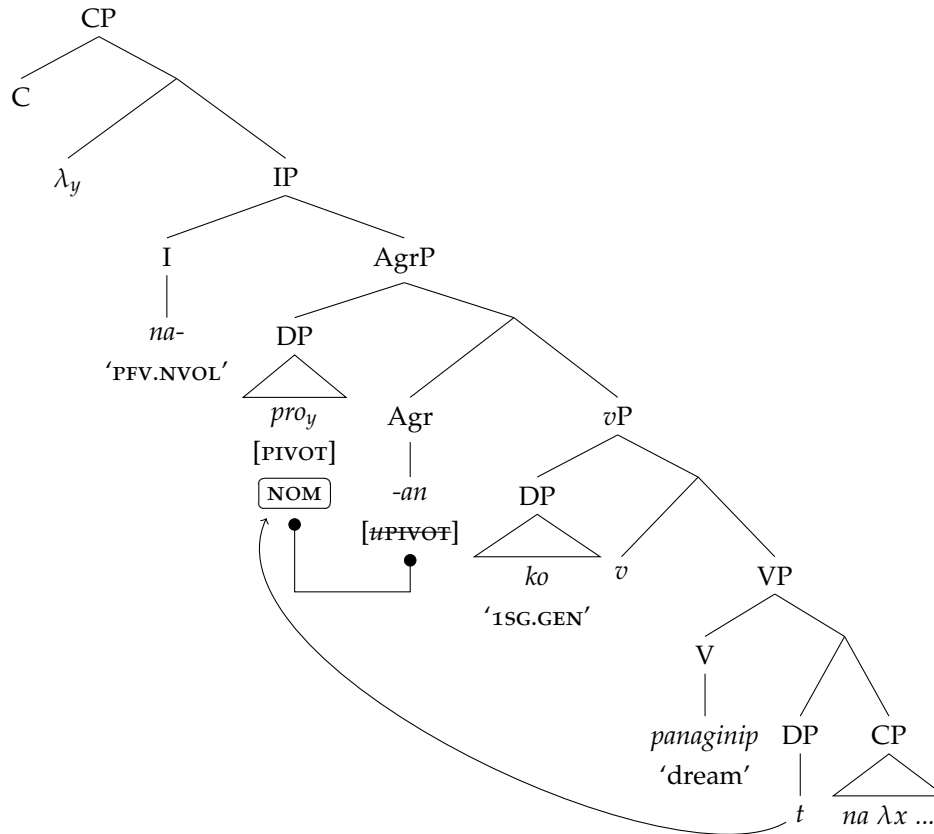

(59) MATRIX CLAUSE, LONG-DISTANCE DEPENDENCY<sup>17</sup>

(59) also shows that this agreement with  $pro_y$  results in matrix  $Agr^0$  being spelled out as the LV suffix *-an*, which gives us the voice form of *panaginip* ‘dream’ that conforms to the MVC. To see how this happens, recall from (48), repeated as (60a), that the LV form of this verb is also the voice form that designates DP themes of this verb as pivots. Assuming that,  $pro_y$  and the theme in (60a) have the same formal status in the structure before (matrix)  $Agr^0$  enters the derivation, we predict that subsequent Agree with  $Agr^0$  should have the same result, particularly with respect to the voice morpheme that is spelled out. Again, as with local dependencies, [PIVOT] may in principle appear on another argument, such as the matrix agent, causing  $Agr^0$  to agree with this DP instead, in turn resulting in the agent being the pivot and the verb appearing in the AV form. Such an alternative derivation is ultimately ruled out, however, as it would leave *pro* within *vP* and insufficiently local to the clause-edge operator.

- (60) a. Na-panaginip-**an** ko {si Diego/ang duwende/iyon }.  
 PFV.NVOL-dream-LV 1SG.GEN NOM.P Diego NOM dwarf DIST.NOM  
 ‘I dreamt {about Diego / about the dwarf / (about) that}.’ DP complement
- b. Na-panaginip-**an** ko [*pro* na h<in>uli ni Diego ang duwende].  
 PFV.NVOL-dream-LV 1SG.GEN LK <PFV>catch[PV] GEN.P Diego NOM dwarf  
 ‘I dreamt that Diego caught the dwarf.’ Declarative CP complement

<sup>17</sup>I am simplifying the representation of the non-volitional form here (realized as the morpheme *na-*). I assume that it does not change the crucial points of the current issue at hand.



Now, from the structure in (59), we have semantic denotation derived in (61). The result is a predicate that holds of an individual  $x$  if the speaker had a dream, and in the possible worlds compatible with the contents of that dream,  $x$  was caught by Diego.

(61) SEMANTIC DERIVATION OF (59)

- a.  $\llbracket \text{VP} \rrbracket^w = \lambda e [\forall v \in W [\text{dream}_w(e)(v) = 1 \rightarrow$   
 $\exists e' [\text{catch}_v(y)(e') \wedge \text{agent}(\text{Diego})(e') \wedge \tau(e') < \text{now}]]]$   $\langle v, t \rangle$   
from (58e)
- b.  $\llbracket vP \rrbracket^w = \lambda e [\text{agent}(\text{spkr})(e) \wedge \forall v \in W [\text{dream}_w(e)(v) = 1 \rightarrow$   
 $\exists e' [\text{catch}_v(y)(e') \wedge \text{agent}(\text{Diego})(e') \wedge \tau(e') < \text{now}]]]$   $\langle v, t \rangle$
- c.  $\llbracket \text{CP} \rrbracket^w = \lambda y [\exists e [\text{agent}(\text{spkr})(e) \wedge \tau(e) < \text{now} \wedge \forall v \in W [\text{dream}_w(e)(v) = 1 \rightarrow$   
 $\exists e' [\text{catch}_v(y)(e') \wedge \text{agent}(\text{Diego})(e') \wedge \tau(e') < \text{now}]]]]]$   $\langle e, t \rangle$

At this point, the derivation proceeds identically to local dependencies: the CP can combine directly with a determiner to produce a headless relative clause, or first with a noun phrase to produce a headed one, as in (62).

- (62) a. ang [na-panaginip-**an** ko=ng  $pro_y$  [<sub>CP</sub> h<in>uli- $\emptyset$  ni Diego  $pro_x$ ]]  
 NOM PFV.NVOL-dream-LV 1SG.GEN=LK <PFV>catch-PV GEN.P Diego  
 ‘The one that I dreamt that Diego caught’
- b. duwende=ng [na-panaginip-**an** ko=ng  $pro_y$  [<sub>CP</sub> h<in>uli- $\emptyset$  ni Diego  $pro_x$ ]]  
 dwarf=LK PFV.NVOL-dream-LV 1SG.GEN=LK <PFV>catch-PV GEN.P Diego  
 ‘dwarf that I dreamt that Diego caught’

Thus we arrive at a the desired result of a long-distance DP  $A'$ -dependency, specifically a relative clause. Other than the proposed semantic type clash that is resolved by the syntactic mechanism of *pro*-insertion, the analysis developed here relied mainly on assumptions independently needed to account for the simpler case of local dependencies discussed in Section 5.3. As such, much of the behavior between local and long-distance dependencies is derived in the same way, through the locality requirement on the binding of *pro*.

Note also that this analysis derives long-distance dependencies without resorting to long-distance  $A'$ -movement (i.e., movement crossing clause boundaries) as is otherwise conventional for many languages including English. Instead, the effect of long-distance dependencies is replicated with multiple semi-independent instances of operations that occur entirely within their immediate containing clause. As mentioned previously, the core of this alternative approach lies in the semantic type clash that I posit to occur in the composition of a verb and its clausal complement when that clausal complement contains an instance of *pro*. Given the centrality of this component of the analysis, I devote the rest of this chapter to arguing for its necessity, comparing it with existing proposals accounting for parallel phenomena.

## 5.5 Interim summary and discussion

Thus far, I have proposed an analysis for the formation of Tagalog DP relative clauses that relies not on the conventional mechanism of  $A'$ -movement, but rather a null pronoun, which I refer to as *pro*. This pronoun is bound by an operator that is introduced at the clause edge, and, I claim, that exhibits a locality constraint in what it can bind. The result of this locality constraint is that *pro* in its base (thematic) position within the  $vP$  of a typical declarative clause is not sufficiently local to the operator. I have showed in this chapter that one way this locality may be achieved is through pivot movement to Spec-AgrP, as facilitated by [PIVOT]. Thus if *pro* bears [PIVOT] and moves to Spec-AgrP, it can be bound by the operator, with the end result being a predicate of individuals (semantic type  $\langle e, t \rangle$ ). Otherwise, if a different argument bears [PIVOT] and *pro* remains in  $vP$ , binding fails. This derives the commonly observed pivot-only restriction, particularly in local dependencies. As previously mentioned, we will see alternative means for locality to be satisfied in Chapter 6.

In cases with long-distance dependencies (i.e., those crossing multiple clause boundaries), the derivation of the *embedded* clause containing the relativized position proceeds identically to the local dependency case, including the introduction of the operator, which I claimed was due to the locality of binding. As with local dependencies, this results in a construction of type  $\langle e, t \rangle$ . At this point in the derivation, the embedded clause is of the wrong semantic type to compose with the higher clause-embedding verb. I thus proposed that this semantic clash necessitates the introduction of another instance of *pro*, which itself must be bound by another operator in the matrix clause edge, subject to the same locality constraint that we have seen. The appearance of this intermediate *pro* accounts for the Matrix Verb Constraint, which is a restriction on the voice form that embedding verbs can take in these long-distance contexts.

At this point, we may ask two major questions. The first question concerns the identity of *pro* and its relationship to the  $\lambda$ -operator. So far we have only seen cases where these two elements co-occur. The question is then whether or not *pro* is formally distinct from other types of null pronouns previously proposed. Answering this question requires further research, but there is some indication that the answer is ‘no’, and that *pro* may in fact have other uses as a null pronoun and is in fact independent from the  $\lambda$ -operator. Two possibilities pointed out by Toosarvandani (2011, 2014) for Northern Paiute appear to apply to Tagalog as well. First, null pronouns can occur independently of the  $\lambda$ -operator in contexts such as discourse-based *pro*-drop or arbitrary PRO shown in (63).

- (63) a. Q: May ice cream pa ba? ..... A: Ubós na *pro*.  
           EXIS ice cream still Q                   depleted already  
           ‘Q: Is there still ice cream? ..... A: (It’s) All gone.’
- b. Hindi biro [ang mag-tanim PRO (ng palay)].  
           NEG joke NOM AV-plant                   GEN rice.plant  
           ‘To {plant/farm} (rice) is no joke.’

Second, the  $\lambda$ -operator appearing without a null pronoun could be relevant for deriving internally headed relative clauses such as (64). Toosarvandani (2011) proposes that in Northern Paiute, bare nouns introduce variables (following (Heim 1982)), and thus can also be bound by  $\lambda$  to result in this type of relative clause.<sup>18</sup>

<sup>18</sup>See also Aldridge 2017b for an account intuitively along these lines for Tagalog that is couched in different base assumptions.

- (64) ang  $\lambda_x$  [b<in>ili=ng **bolpen**<sub>x</sub> ng guro sa tindahan]  
 NOM <PFV>buy[PV] pen GEN teacher OBL store  
 ‘the pen that the teacher bought at the store’

The other major question has to do with how the proposed analysis fits in with previous analyses of A'-dependency formation. The analysis of relative clauses proposed in this chapter is in some sense a hybrid, intuitively having attributes of both traditional movement and non-movement analyses. As discussed at the beginning of this chapter, a true movement analysis is ultimately eschewed due to the structural differences between DP and non-DP A'-dependencies (see Chapter 4), which are accounted for through a strong locality requirement on Case licensing. However, in at least two other respects, the current proposal strongly resembles standard movement-based accounts.

First is the locality constraint, which was relevant to the derivation of the pivot-only restriction in local dependencies, as well as its manifestation in long-distance dependencies, the MVC. The effect of this locality constraint in the examples considered thus far was that *pro* needed to move out of the thematic domain (*vP*) in order to be sufficiently local to the operator. Such situations are strongly reminiscent of XPs undergoing standard A'-movement needing to escape the *vP* phase. Second is the successive-cyclic signature stemming from locality of binding that is illustrated schematically in (65). The current analysis is represented as (65a), where we see two instances of *pro*. In this structure, the  $\lambda$ -operator at the edge of the embedded clause and subsequent intermediate instance of *pro* are strongly reminiscent of the configuration typically assumed for successive-cyclic long-distance movement (65b). This approach moreover contrasts with previously proposed non-movement analyses of relativization (e.g., McCloskey 2002), where the variable-introducing pronoun may be bound long-distance across multiple clause boundaries, as (65c) illustrates.

- (65) a. [<sub>CP</sub>  $\lambda_y$  ... *pro*<sub>y</sub> [<sub>CP</sub>  $\lambda_x$  ... *pro*<sub>x</sub> ... ]] “Successive-cyclic” binding  
 b. [<sub>CP</sub> *Op*<sub>x</sub> ... [<sub>CP</sub> *t*<sub>x</sub> ... *t*<sub>x</sub> ... ]] Successive-cyclic movement  
 c. [<sub>CP</sub>  $\lambda_x$  ... [<sub>CP</sub> ... *pro*<sub>x</sub> ... ]] Long-distance binding

Given these two points of similarity with more conventional A'-movement analyses, a reasonable concern to raise at this point is thus whether or not we are in fact reinventing the wheel. Are the additional pieces of machinery (*pro*, locality of binding) warranted, or are these A'-dependencies in fact better analyzed as constructions involving true movement? In the next section, I address this question as it relates to the successive cyclic behavior of long-distance dependencies by considering alternative accounts for Tagalog A'-dependencies, including those involving conventional A'-movement, and show that they do not derive the correct behavior for Tagalog. Specifically, it will be claimed that true movement out of CP in Tagalog is impossible. On the other hand, the locality constraint on the binding of *pro* is explored in more detail in Chapter 6. Particularly, in Section 6.5, we will see that in certain constructions with reduced clausal structure, binding *pro* in *vP* becomes possible, which is unexpected under the view that *vP* is a phase.

## 5.6 Comparison to alternative approaches

So far, I have demonstrated that the current proposal derives the voice-agreeing subset of local and long-distance relativization patterns in Tagalog. The analysis accounts for this behavior without appealing to standard  $A'$ -movement, instead introducing a complication in the form of a null *pro* with a particular set of properties. Given these complications, the question was raised in the previous section of what advantage this approach has over previous accounts, particularly ones that appeal to movement, to justify rejecting them.

In comparing the various analyses of DP  $A'$ -dependencies in Tagalog, the area of long-distance dependencies is important to consider, as these environments provide the clearest evidence to adjudicate between the different approaches. In particular, we will see that different analyses account for the Matrix Verb Constraint in different ways, which vary in their specific predictions for long-distance  $A'$ -dependencies more generally.

In this section, I discuss two main analyses and compare them to the current proposal. First, as a representative for successive-cyclic movement analyses, I consider the proposal by Rackowski and Richards (2005) and show that such approaches overgenerate in terms of what kinds of long-distance dependencies should be possible. Specifically, I present data showing that long-distance *non-DP* dependencies are not universally accepted by speakers. I argue that such data suggests that true long-distance movement across multiple clause boundaries is in fact impossible in Tagalog. Second, I consider a non-movement analysis proposed by Kaufman (2011), which adopts a different account for the Matrix Verb Constraint that does not require positing the successive-cyclic *binding* previously discussed in Section 5.5. However, we will see that such an approach does not straightforwardly derive the expected semantics for clausal embeddings.

Before discussing these analyses in detail, let us first set the stage by briefly discussing the possibility of long-distance binding, and considering why this approach fails to account for the Matrix Voice Constraint.

### 5.6.1 Long-distance binding

In the formation of  $A'$ -dependencies, movement and non-movement approaches are known to show different characteristic patterns (see, e.g., McCloskey 1990, 2002). Movement approaches are expected to show successive-cyclic effects as the result of movement to intermediate landing sites at phase edges. On the other hand non-movement approaches typically assume a pronoun introduced in a relevant thematic position that can then be bound by an operator that is arbitrarily high. In this case, we expect no successive-cyclic effects.

The typical long-distance binding mechanism in non-movement approaches contrasts with the proposal in Section 5.4, where intermediate instances of *pro* ( $pro_y$ ) are introduced around intervening CP edges. As mentioned in Section 5.5, these intermediate instances of *pro* are strongly reminiscent of a successive-cyclic effect. This difference is repeated in the schematized structures in (66).

(66) a.  $[_{CP} \lambda_y \dots pro_y [_{CP} \lambda_x \dots pro_x \dots ]]$  “Successive-Cyclic” Binding

- b.  $[_{CP} Op_x \dots [_{CP} t_x \dots t_x \dots ]]$  Successive-cyclic movement
- c.  $[_{CP} \lambda_x \dots [_{CP} \dots pro_x \dots ]]$  Long-Distance Binding

Under the current non-movement approach, intermediate instances of *pro* (e.g.,  $pro_y$  in (66a)) are necessary to derive the Matrix Verb Constraint, as these are posited to restrict the voice forms of higher verbs in a long-distance dependency. This constraint is not readily captured by long-distance binding, as the examples in (67) illustrate. As in previous examples, subscripts on the verb indicate the relevant argument controlling voice morphology. If *pro* is assumed to appear only in the relative clause gap position, then we do not have a straightforward way to restrict the form of the matrix verb, and we incorrectly predict examples like (67a) to be possible.

(67) LONG-DISTANCE BINDING DOES NOT CAPTURE THE MATRIX VERB CONSTRAINT

- a. \**puno=ng*  $\lambda_x$ [**n-anaginip**<sub>y</sub> ang laláki<sub>y</sub> na [<sub>y</sub>t<in>i~tirh-an<sub>x</sub> ng isa=ng tikbalang *pro*<sub>x</sub>]]  
 tree=LK AV.PFV-dream NOM man LK IMPF~reside-LV GEN one=LK *tikbalang*  
 Intended: ‘tree [that the man dreamt [that a *tikbalang*<sup>19</sup> lives in]]’
- b. *puno=ng*  $\lambda_x$ [**na-panaginip-an**<sub>y</sub> ng laláki na [<sub>y</sub>t<in>i~tirh-an<sub>x</sub> ng isa=ng tikbalang *pro*<sub>x</sub>]]  
 tree=LK PFV.NVOL-dream-LV GEN man LK IMPF~reside-LV GEN one=LK *tikbalang*  
 ‘tree [that the man dreamt [that a *tikbalang* lives in]]’

In the current analysis, the intermediate instances of *pro* are introduced as a repair for a semantic type mismatch, which in turn is due to an intermediate  $\lambda$ -operator introduced at the edge of embedded clauses. I assume that these intermediate operators arise due to the locality constraint on the binding of *pro*. That is, *pro* in the embedded clause is insufficiently local to the operator in the matrix clause to be bound, so an intermediate operator must be inserted. However, while I argue for the validity of this locality constraint as a robust generalization in Chapter 6, I stop short of proposing a formal account of it. It may thus be contended that this part of the analysis relies on a stipulation to simulate the successive-cyclic signature of a movement-based analysis. This raises the questions of whether the non-movement approach is a non-starter, and whether we should pursue a movement-based analysis instead. I argue in the negative in the next subsection by showing that movement approaches overgenerate when considering the broader range of *A'*-dependencies in Tagalog.

### 5.6.2 Successive-cyclic movement

Having seen that the typical formulation of a non-movement approach is inadequate for capturing the Matrix Verb Constraint in Tagalog long-distance *A'*-dependencies, let us now consider how a movement-based analysis accounts for the behavior we find in Tagalog. The crucial data for this discussion comes from long-distance *A'*-dependencies of non-DPs. We will see that such constructions are more equivocal than previously thought, and once we control for confounding factors, it becomes doubtful whether non-DPs may be targeted for long-distance *A'*-dependencies at all. I argue here that such data is problematic

<sup>19</sup>A *tikbalang* is a mythical creature in Philippine folklore that has the torso and general body shape of a human, but the head, legs, and tail of a horse.

for successive-cyclic movement-based approaches, since predict parallel behavior from both DPs and non-DPs.

On the other hand, the analysis developed in this thesis handles this asymmetry fairly readily if we assume that CP is a phase that nothing may move out of. Given the A'-movement-based analysis of non-DP dependencies proposed in Chapter 7, the impossibility of long-distance non-DP dependencies can be tied to the presence of the CP phase edge. On the other hand, because long-distance DP dependencies crucially do *not* rely on (successive-cyclic) movement out of CP, as laid out in Section 5.4, we predict that the CP phase edge should not block their formation. Put differently, long-distance A'-dependencies are one environment where we can detect the different locality signatures of the two mechanisms (*pro*-binding and A'-movement) adopted in this thesis for A'-dependency formation.

For the current discussion, let us take the analysis by Rackowski and Richards (2005) as representative of movement approaches generally, as it makes concrete proposals for the behavior of long-distance dependencies. This movement-based approach makes use of an Agree relation probed by  $v^0$ . Similar to the function of my proposed  $\text{Agr}^0$ , the Agree relation that they propose is responsible for assigning *ang*-marking<sup>20</sup> on an argument and is spelled out as voice morphology on the verb. They characterize this relation as Case agreement, which is to say that the morphological form of  $v^0$  co-varies with the value of abstract Case that the pivot bears. For them, however, Case agreement is also responsible for feeding further A'-movement.

Rackowski and Richards propose that CPs can receive abstract Case (although this does not result in overt morphological case marking) and that they can participate in Case agreement. When they do so (i.e., enter into an Agree relation with a c-commanding  $v^0$ ), they become “unlocked”, and subsequent probes on the same head may access material within the CP. Thus, once Case agreement has taken place, a *wh*-probe on  $v^0$  may probe inside the CP to agree with the intended goal in the embedded clause. Because Case agreement is tied to the realization of voice, this proposal derives the Matrix Verb Constraint.<sup>21</sup>

Part of the evidence that Rackowski and Richards provide to support their analysis comes from the reported behavior of non-DP A'-dependencies. Recall from Chapter 4 that local non-DP A'-dependencies do not interact with voice. As a reminder, the examples in (68) show that the oblique location/goal argument can be focused or relativized despite nominative appearing on a different argument in the clause (underlined).

(68) LOCAL EXTRACTION OF NON-DPs DOES NOT INTERACT WITH VOICE

- a. I-la~lagay ni Benjie ang bulaklak sa pasô.  
 CV-FUT~put GEN.P Benjie NOM flower OBL pot  
 ‘Benjie will put the flower in the pot.’ Baseline
- b. {Sa pasô/Saan } i-la~lagay ni Benjie ang bulaklak.  
 OBL pot where CV-FUT~put GEN.P Benjie NOM flower  
 ‘It’s in the pot that Benjie will put the flower.’  
 ‘Where will Benjie put the flower?’ Focus fronting

<sup>20</sup>They assume that this marking is *not* nominative case.

<sup>21</sup>Rackowski and Richards (2005, pp.587–8) also propose that Case agreement feeds local extraction, since Case agreement triggers movement to Spec-*v*P, which serves as an escape hatch for the *v*P phase.

- c. ang pasô kung saan i-la~lagay ni Benjie ang bulaklak  
 NOM pot if where CV-FUT~put GEN.P Benjie NOM flower  
 ‘the pot where Benjie will put the flower’ Kung-relative

In contrast to this behavior in the context of local dependencies, Rackowski and Richards (2005) present data showing that the Matrix Verb Constraint nevertheless holds for non-DP extraction. They argue that this data shows that the step of Case agreement with the complement CP is not only required for long-distance DP extraction, but also for long-distance non-DP extraction. The proposed unlocking operation is thus a general part of extraction in Tagalog. Some of the data they provide is given below.

(69) LD-EXTRACTION OF NON-DPs INTERACTS WITH VOICE ON THE MATRIX VERB

(Rackowski and Richards 2005, exx.49–50, judgements as reported)

- a. Kailan [i-p<in>angako nang sundalo [na Ø-u~uwi ang pangulo e]]?  
 when CV-<PFV>promise GEN soldier LK AV-FUT~go.home NOM president  
 ‘When did the soldier promise that the president would go home?’
- b. \*Kailan [n-angako ang sundalo [na Ø-u~uwi ang pangulo e]]?  
 when AV.PFV-promise NOM soldier LK AV-FUT~go.home NOM president  
 ‘When did the soldier promise that the president would go home?’
- c. Kailan [p<in>aniwala-an nang sundalo [na Ø-u~uwi ang pangulo e]]?  
 when <PFV>believe-LV GEN soldier LK AV-FUT~go.home NOM president  
 ‘When did the soldier believe that the president would go home?’
- d. \*Kailan [n-aniwala ang sundalo [na Ø-u~uwi ang pangulo e]]?  
 when AV.PFV-believe NOM soldier LK AV-FUT~go.home NOM president  
 ‘When did the soldier believe that the president would go home?’

However, the data is not as clear-cut as reported by Rackowski and Richards (2005). Speakers I have consulted with have expressed variable acceptance for the embedded construal of the A'-extracted non-DP. For example, these speakers report that the pair of questions (69a-b) can only be asking about the time the promise was made and not the time of the president's returning.<sup>22</sup> Notably, they did not appear to judge the two sentences as different.

It is possible that processing factors are at play here. For example, if both matrix and embedded construals are equally plausible, then speakers may prefer the easier matrix construal, even to the point of judging the embedded construal to be impossible or ungrammatical. However, closer investigation suggests that this hypothesis does not hold up.

In cases where matrix construal is dispreferred, say for pragmatic reasons or because the relevant

<sup>22</sup>Consultant A volunteered the following to get construal of *kailan* ‘when’ with *uwi* ‘go home’. We see that the verb has been rendered as a gerund, with the former matrix verb *ipinangako* now modifying it as a relative clause.

(i) Kailan ang i-p<in>ang-áko=ng pag-uwi ng pangulo?  
 when NOM CV-<PFV>paN-promise=LK pag-go.home[GER] GEN president  
 ‘When is the promised return of the president?’

non-DP is a semantic argument of the embedded verb, embedded construal is often still unavailable. For example, (70) was judged by two out of three speakers consulted to be ill-formed.

(70) Saan na-balita-an ng guro [na p<um>unta si Jenny]?  
 where PFV.NVOL-news-LV GEN teacher LK <AV>go(PFV) NOM.P Jenny

‘Where did the teacher hear that Jenny went?’

a. Consultant A: ✓

Comment:<sup>23</sup> Can be asking about where the teacher heard the news or where Jenny (reportedly) went

b. Consultant B: \*?

Comment: Confusing

c. Consultant C: \*

My Comment: Hard to get the embedded association, even if the embedded clause needs an argument

Consultant C in particular indicated that the embedded clause in this example seemed to be missing something, and volunteered the two sentences in (71) that resolved the perceived ill-formedness of (70). In both cases, *saan* ‘where’ has matrix construal (associated with *nabalitaan* ‘heard (LV)’), and the goal argument slot of the embedded verb *punta* ‘go’ is independently saturated. In (71a), we have a goal-targeted headless relative, while in (71b), we have a second instance of *saan* ‘where’, suggesting either an embedded question or a free relative.

(71) FIXES TO (70) VOLUNTEERED BY CONSULTANT C (MATRIX CONSTRUAL ONLY)

a. Saan<sub>i</sub> na-balita-an ng guro *t<sub>i</sub>* [ang p<in>untah-an ni Jenny]?  
 where PFV.NVOL-news-LV GEN teacher NOM <PFV>go-LV GEN.P Jenny

‘Where did the teacher hear about [the place where Jenny went]?’

‘What *x* is such that the teacher heard in *x* about [the place Jenny went to]?’

b. Saan<sub>i</sub> na-balita-an ng guro *t<sub>i</sub>* [kung saan p<um>unta si Jenny]?  
 where PFV.NVOL-news-LV GEN teacher if where <AV>go(PFV) NOM.P Jenny

‘Where did the teacher hear [about where Jenny went]?’

‘What *x* is such that the teacher heard in *x* [where Jenny went]?’

We also find cases where the matrix construal is pragmatically strange. The examples in (72), show attempted long-distance extraction of the embedded location shown in the baseline (72a). It is unusual to modify an event of believing with a location, so we expect the embedded construal with *tago* ‘hide’ to be more salient. However, (72b-c) show that this expectation is not borne out.

(72) EMBEDDED CONSTRUAL UNAVAILABLE WITH *paniwala* ‘believe’

a. Nani~niwala ang pulis [na nagta~tago ang magnanakaw doon].  
 AV.paN.IMPF-believe NOM police LK AV.IMPF~hide NOM thief DIST.OBL

‘The police believe that the thief is hiding there.’

Baseline

<sup>23</sup>I have paraphrased these comments to some extent.



- b. \*Doon<sub>i</sub> p<in>ani~niwala-an ng pulis [na nagta~tago ang magnanakaw t<sub>i</sub>].  
 DIST.OBL paN.IMPF~believe-LV GEN police LK AV.IMPF~hide NOM thief

Intended: 'It's there<sub>i</sub> that the police believe [that the thief is hiding t<sub>i</sub>].'

Comment: 'I know what you mean, but it doesn't sound right'

- c. \*Doon<sub>i</sub> nani~niwala ang pulis [na nagta~tago ang magnanakaw t<sub>i</sub>].  
 DIST.OBL AV.paN.IMPF~believe NOM police LK AV.IMPF~hide NOM thief

Intended: 'It's there<sub>i</sub> that the police believe [that the thief is hiding t<sub>i</sub>].'

Comment: 'Pinaniniwalaan sounds weirder, but this one is also bad'

We find a similar situation in (73), showing attempted long-distance focus of an embedded location in the baseline sentence (73a). In this case, the example with focus (73b) was judged by Consultant C as pragmatically strange, but was accepted by Consultant B. This variability nevertheless contrasts with the consistent grammatical judgment given to the baseline sentence.

(73) PRAGMATICALLY STRANGE CONSTRUAL WITH *sinabi* 'said (PV)'

- a. S<in>abi niya [na nag-pa-tattoo siya sa braso].  
 <PFV>say[PV] 3SG.GEN LK AV.PFV-CAUS-tattoo 3SG.NOM OBL arm

'She said that she got a tattoo on the arm.'

Baseline

- b. [Sa braso]<sub>i</sub> niya s<in>abi [na nag-pa-tattoo siya t<sub>i</sub>].  
 OBL arm 3SG.GEN <PFV>say[PV] LK AV.PFV-CAUS-tattoo 3SG.NOM

Intended: 'It was [on the arm]<sub>i</sub> that she said [she got a tattoo t<sub>i</sub>].'

Consultant B: ✓; "It's OK."

Consultant C: #; "It sounds like this person told her arm that she got a tattoo."

Also contrasting with this variability is the consistent acceptability of even multiply embedded long-distance DP dependencies, as (74) shows.

- (74) Iyon ang [akala ko=ng [s<in>abi mo=ng [ga~gaw-in mo]]], pero iba pala.  
 DIST NOM thought 1SG.GEN=LK <PFV>say[PV] 2SG.GEN=LK FUT~do-PV 2SG.GEN but different after.all

'That's [what I thought [you said [you would do]]], but it was something else after all.'

The data presented here for long-distance non-DP dependencies, while not strongly showing ungrammaticality, shows us that long-distance dependencies of DPs and of non-DPs (if possible), behave differently in a way that we would not expect if the same mechanisms governed their formation, as Rackowski and Richards (2005) propose.<sup>24</sup> More concretely, a general movement approach cannot capture the differential behavior of DPs and non-DPs discussed in this section.<sup>25</sup> Movement approaches for A'-dependencies commonly assume that some kind of A'-feature (e.g., [WH] or [REL]) is lexically specified on

<sup>24</sup>Future work on this topic would likely benefit from a more controlled method of investigation than simple elicitation in order to whether such dependencies are indeed ill-formed or some other explanation holds (e.g., long-distance dependencies are more difficult to process generally).

<sup>25</sup>Rackowski and Richards (2005) briefly discuss the behavior of bridge and non-bridge verbs, presenting data that appears parallel to the data discussed here. That is, the sentences in their (73) show that a non-bridge verb like English *deny* allows long-distance extraction of an embedded DP (*What did they deny that...*) but not of a non-DP (*\*When did they deny that...*). They speculate that one might account for these facts by positing that "the features on the v associated with a non-bridge verb have some kind of privileged association with DP". However, they leave the investigation and formulation of such a proposal for future work.

the dependency target and is subsequently establishes an Agree relation with a c-commanding A'-probe. Furthermore, in long-distance contexts, it is usually assumed that the moved XP is able to evacuate phases (embedded CP in particular) either by first occupying intermediate landing sites at the edge of the phase, or by the phase itself being "unlocked" (as in Rackowski and Richards's analysis).

A crucial standard assumption about A'-features is that they are not sensitive to DP-hood, so the differential behavior cannot be derived in a principled manner by simply positing variation in this probe/feature. Appealing to the mechanism for crossing phase boundaries also does not readily derive the correct results. This would amount to either positing that non-DPs do not move to the intermediate landing site, or that the phase remains opaque just in case the XP to be A'-moved out of it is not a DP. The first option runs into a problem that we have already encountered, as intermediate movement is also standardly driven by A'-features. As for the second option, it is not clear how to derive this kind of conditional opacity for the phase, as at the relevant unlocking step, the probe presumably only has access to information at or outside the phase edge (i.e., it should not be able to look ahead). Specifically for Rackowski and Richards (2005), the proposed unlocking behavior is a side-effect of Case agreement, which crucially occurs independently from A'-extraction. It seems conceptually incompatible to propose that information relevant only for A'-extraction by assumption to affect a process that occurs independently from it.<sup>26</sup>

Following the analysis proposed here, the differential behavior of DPs and non-DPs with respect to long-distance dependencies can be understood as a natural consequence of the different mechanisms that derive them. I assume that the phase-unlocking mechanism proposed by Rackowski and Richards (2005) is unavailable in Tagalog, so no long-distance dependencies can be formed through (A'-)movement out of CP.<sup>27</sup> Following the movement-based analysis of non-DP dependencies proposed in Chapter 7 then provides us a starting point for deriving the ungrammatical cases that we find. The variable behavior of these dependencies, while still unaccounted for, is less problematic for the analysis of long-distance DP dependencies, as they involve a distinct mechanism of successive-cyclic *pro*-binding.

### 5.6.3 (Putative) Long-distance dependencies through relative clause stacking

We have just seen an argument against movement approaches for long-distance DP dependencies in Tagalog, thus supporting the adoption of a the successive-cyclic *pro*-binding approach. However, recall that this proposal relies on a stipulation that essentially simulates the successive cyclic signature of movement approaches to derive the Matrix Verb Constraint. We might thus reasonably ask whether or not the Matrix Verb Constraint can be derived in an alternative manner with a true non-movement approach, notwithstanding the discussion in Section 5.6.1. Here, I consider one such alternative proposed by Kaufman (2011), and show that while it successfully derives the MVC, it does not correctly account for the

<sup>26</sup>In contrast, it may be possible to derive the aforementioned conditional opacity under recent proposals that tie the assignment of nominative Case to C<sup>0</sup> or another functional head in the clause periphery (e.g., Aldridge 2017b; Erlewine et al. 2015). We might assume, for example, that in the process of (embedded) C<sup>0</sup> assigning nominative to a DP, it may copy other features (following Deal 2015), such as a *wh*-feature. We might then posit that the embedded CP is somehow transparent or unlockable if it bears a *wh*-feature. Crucially, if the *wh*-feature appears not on the eventual nominative DP, but on a non-DP, then the embedded CP will not be able to copy the *wh*-feature, and thus would not be transparent or unlockable. Given that I argue for the locus of nominative being syntactically lower in Tagalog (i.e., Agr<sup>0</sup>), I do not pursue this line of inquiry further here.

<sup>27</sup>Further arguments against this unlocking mechanism are presented in Sec. 6.4.

intensional semantics of clausal embedding.<sup>28</sup>

As part of a broader proposal arguing against a formal distinction between nouns and verbs in Tagalog (Kaufman 2009), Kaufman (2011) proposes that Tagalog does not form true long-distance A'-dependencies at all. Instead, he argues that all putative long-distance A'-dependencies in Tagalog actually involve a flatter, non-hierarchical stacking of two (or more) modifiers.<sup>29</sup> This structure is illustrated by the bracketing in (75), where the two verbs *panaginip* 'dream' and *tirá* 'reside' form two separate modifiers, with the linker *na* mediating between them. Recall that the linker is used not only in clausal embedding, but also in modification.

(75) NON-HIERARCHICAL STRUCTURE FOR APPARENT LONG-DISTANCE DEPENDENCIES

- a. puno=ng [na-panaginip-an<sub>y</sub> ng laláki *pro*<sub>y</sub>] na [t<in>i~tirh-an<sub>x</sub> ng isa=ng tikbalang *pro*<sub>x</sub>]  
 tree=LK PFV.NVOL-dream-LV GEN man LK IMPF~reside-LV GEN one=LK *tikbalang*  
 'tree [that the man dreamt [that a *tikbalang* lives in]]'
- b. \*puno=ng [n-anaginip<sub>y</sub> ang laláki<sub>y</sub> *pro*] na [t<in>i~tirh-an<sub>x</sub> ng isa=ng tikbalang *pro*<sub>x</sub>]  
 tree=LK AV.PFV-dream NOM man LK IMPF~reside-LV GEN one=LK *tikbalang*  
 Intended: 'tree [that the man dreamt [that a *tikbalang* lives in]]'

The plausibility of this stacked relative clause analysis is supported by the fact that embedding predicates in Tagalog can take clear DP (i.e., non-clausal, non-prepositional) arguments. We saw this previously in Section 5.4.1, with relevant examples given again in (76). In (76a), we see that *napanaginipan* 'dreamt (LV)' can take a DP or a clausal object, while (76b) shows that this verb can also appear in a relative clause on its own without an embedded verb, in contrast to (75a). Furthermore, modifiers predicated by the apparent embedding verb can appear linearly second. Thus compare (75a) to (77).

(76) CLAUSE-EMBEDDING VERBS CAN TAKE DP OBJECTS

- a. Na-panaginip-an ko {si Diego/na l<um>i~lipad ako}.  
 PFV.NVOL-dream-LV 1SG.GEN NOM.P Diego LK AV.IMPF~fly 1SG.NOM  
 'I dreamt {about Diego/that I was flying}.'
- b. puno=ng [na-panaginip-an ng laláki *pro*]  
 tree=LK PFV.NVOL-dream-LV GEN man  
 'tree that the man dreamt about]

(77) SWITCHED ORDER OF MODIFIERS

- puno=ng [t<in>i~tirh-an<sub>x</sub> ng isa=ng tikbalang *pro*<sub>x</sub>] na [na-panaginip-an<sub>y</sub> ng laláki *pro*<sub>y</sub>]  
 tree=LK IMPF~reside-LV GEN one=LK *tikbalang* LK PFV.NVOL-dream-LV GEN man  
 'tree [that a *tikbalang* lives in] [that the man dreamt about]'

<sup>28</sup>See also Hsieh 2019.

<sup>29</sup>Kaufman (2009) assumes that Tagalog does not have relative clauses, as a consequence of his proposed collapsing of nouns and verbs in this language. Instead, modifiers that look like relative clauses are in fact complex nominals that denote predicates of individuals.

The clear advantage of this approach is that it straightforwardly derives the Matrix Verb Constraint as just an instance of the regular pivot-only restriction as it manifests in local dependencies. Thus, the reason why embedding verbs like *panaginip* ‘dream’ require a specific voice form in (apparent) long-distance dependencies is because the dependency *directly targets* the relevant argument of such verbs. In terms of the analysis proposed in this thesis, this can be formalized as introducing independent instances of *pro* in the relevant positions, as illustrated in (75) and (77). Examples (75a) and (77) are then grammatical because the *pro* argument of *panaginip* ‘dream’ is the pivot of that clause, whereas (75b) is ungrammatical because an argument other than *pro* is the pivot.

This approach to deriving the Matrix Verb Constraint is thus mostly similar to the main approach proposed in this chapter in that both rely on the matrix verb having *pro* as one of its arguments. The presence of *pro* then determines the voice form of the verb. Where the two approaches differ is in why the matrix *pro* is introduced. While the main approach proposed relies on a stipulated mechanism that simulates successive-cyclic behavior, the non-hierarchical stacking approach discussed here accounts for the presence of a second *pro* as the result of having the matrix verb forming an independent modifier. Considering these differences, the non-hierarchical approach appears to be the superior analysis between the two, as it is arguably better motivated.

That said, the non-hierarchical stacking approach is problematic when we consider the associated semantics, which reflects the syntactically non-hierarchical relationship of the two modifiers in constructions like (75) and (77). Kaufman (2011) assumes that both modifiers are of type  $\langle e, t \rangle$ , and can thus compose semantically by a mechanism like Predicate Modification (Heim and Kratzer 1998). This process is identical to how a relative clause composes with a nominal head, as (39) in Section 5.3 showed for a local dependency. The composition is shown more concretely in (78), where we see three separate predicates of type  $\langle e, t \rangle$  that compose via Predicate Modification. Some detail, such as tense information, has been omitted for simplicity.

- (78) [puno]=ng [na-panaginip-an<sub>y</sub> ng laláki *pro*<sub>y</sub>] na [t<in>i~tirh-an<sub>x</sub> ng isa=ng tikbalang *pro*<sub>x</sub>]  
 tree=LK PFV.NVOL-dream-LV GEN man LK IMPF~reside-LV GEN one=LK *tikbalang*  
 ‘[tree] [that the man dreamt] [that a *tikbalang* lives in]’  
 a.  $\llbracket \text{puno} \rrbracket = \lambda x [\text{tree}(x)]$   
 b.  $\llbracket \text{napanaginipan ...} \rrbracket = \lambda x [\exists e [\text{dream}(x)(e) \wedge \text{experiencer}(\text{Man})(e)]]$   
 c.  $\llbracket \text{tinitirhan ...} \rrbracket = \lambda x [\exists y [\exists e [\text{reside}(x)(e) \wedge \text{tikbalang}(y) \wedge \text{agent}(y)(e)]]]$   
 d.  $\llbracket (78) \rrbracket = \lambda x [\text{tree}(x) \wedge \exists e [\text{dream}(x)(e) \wedge \text{experiencer}(\text{Man})(e)] \wedge \exists y [\exists e' [\text{reside}(x)(e') \wedge \text{tikbalang}(y) \wedge \text{agent}(y)(e')]]]$

As expected, the result is a complex predicate of individuals that is true if the component predicates are individually true. That is, (78) holds true of an individual  $x$  if and only if: (i)  $x$  is a tree, (ii) the conversationally salient man dreamt about  $x$ , and (iii) a *tikbalang* lives in  $x$ . Here, we can see the problems in the resulting semantic denotation that stem from the non-hierarchical structure. Because the matrix predicate does not take scope over the embedded one, the semantic contribution of the latter (78c) is not relativized to the appropriate set of (alternative) possible worlds. This has two undesirable effects.

First, the semantic contributions of the embedded and matrix predicates, (78c) and (78b) respectively, are asserted to hold of an individual  $x$  simultaneously in the same set of possible worlds. Concretely, this would mean that if  $x$  is an actual tree that the conversationally salient man actually dreamed about, then a *tikbalang* must also *actually* live in  $x$  for (78) to hold of  $x$ . This is too strong.

Second, the semantic contribution of the matrix predicate (78b) is itself independent of the embedded predicate and cannot “see” its semantic contribution. That is, the contents of the conversationally salient man’s dream do not necessarily have to involve a *tikbalang* residing somewhere. Thus, (78) holds of some entity  $x$  if the conversationally salient man dreamt of  $x$ , but says nothing about the role of  $x$  in this man’s dream. For example, the tree could have been barren in the dream with no creatures living in it. In contrast to the first problem, this result is too weak.

This result thus contrasts with standard analyses of intensional predicates more generally, which assume that embedding predicates take semantic scope over their complements (von Stechow and Heim 2011; Heim and Kratzer 1998). This scope in turn allows the semantic content of the embedded clause to be evaluated relative not to the world of evaluation, but to a set of possible worlds specified by the matrix predicate. In our example, this amounts to the embedded predicate, that a *tikbalang* lives in some  $x$ , being evaluated with respect to the set of possible worlds consistent with what the conversationally salient man dreamt. This set may or may not include the actual world, so the resulting denotation can hold of an individual  $x$  even if no *tikbalang* actually lives in  $x$ .

As was discussed in detail in Section 5.4, the successive-cyclic binding approach is compatible with a standard formulation of intensional semantics. In contrast, it is hard to see how such a semantics can be applied to the non-hierarchical approach, as by assumption, the relevant predicates do not stand in a hierarchical relationship. Therefore, one cannot take scope over the other.<sup>30</sup>

The upshot of this discussion is then that while the successive-cyclic binding approach proposed in this chapter to account for long-distance DP  $A'$ -dependencies and the Matrix Verb Constraint is arguably stipulative, it avoids problems that other straightforward alternatives encounter. On one hand, I showed that movement-based analyses that assume  $A'$ -movement for both DP and non-DP  $A'$ -dependencies are ill-equipped to explain the highly variable grammaticality of long-distance non-DP dependencies, which stand in contrast to the straightforward grammaticality of long-distance DP dependencies. On the other, I considered an alternative non-movement analysis that accounted for the Matrix Verb Constraint without the successive-cyclic stipulation proposed in this chapter, and showed that it resulted in the wrong semantic denotation.

## 5.7 Chapter Summary

In this chapter, I proposed an analysis of the most well-studied types of  $A'$ -dependencies in Tagalog: those that conform to the pivot-only restriction on  $A'$ -dependency formations, where only the nominative-

<sup>30</sup>Interestingly, the non-intensional semantics predicted by the non-hierarchical approach appears to be correct in certain situations, particularly in cases like (77), where the linear order of the predicates is reversed. That is, the salient interpretation for this example (under my own native speaker intuitions) is that it is talking about a tree that a *tikbalang* lives in, and that the conversationally salient man dreamt about. The *tikbalang* is suggested to actually live in the tree, and the man need not have dreamt about the *tikbalang* itself.

marked DP (i.e., the pivot) in a clause can be targeted for focus or relativization.

The main observation that informed the theoretical approach taken in this chapter was the structural difference observed between focus constructions of DPs and non-DPs, previously discussed in Chapter 4. In particular, the fact that DP focus takes the form of a periphrastic pseudocleft was taken to indicate that A'-movement of DPs is impossible in Tagalog. I proposed a formalization of this idea by generalizing Béjar and Massam's (1999) analysis of Multiple Case Checking initially adopted in Chapter 3 to account for the nominal marking patterns found in this language. Specifically, I proposed that the locality condition on PF-interpretability of Case assumed under the MCC analysis is active with any type of movement, and that this broadening of scope has implications for DP licensing. The result is that DPs may only move to positions where Case is assigned. This restriction thus explains why DPs cannot move to the same clause-peripheral focus position that non-DPs can, and therefore why DP focus in this language must be realized periphrastically.

Following this, I proposed an analysis of DP relative clauses in Tagalog that eschews the conventional mechanisms of A'-movement, instead using a null *pro* as a free variable that is bound by an operator higher in the structure. I claimed that the binding relationship between *pro* and the operator is subject to a locality constraint such that in the examples considered in this chapter, *pro* in the thematic domain is insufficiently local to the operator and must therefore escape. I posited that pivot movement constitutes one such escape strategy, thus deriving the behavior conforming to the pivot-only restriction. I further posited that the locality constraint on binding is also ultimately responsible for the Matrix Verb Constraint in long-distance dependencies, as it leads to the semantic type mismatch, necessitating the insertion of the intermediate instance of *pro* that controls the voice form of the matrix verb. Finally, I argued that the successive-cyclic binding approach developed here makes different predictions from alternative proposals—specifically a successive-cyclic movement approach and a true non-movement approach—ultimately showing that the current proposal is better able to account for the attested behavior.

Overall, in this chapter, I have proposed a mechanism for forming DP A'-dependencies in Tagalog that is distinct from conventional A'-movement approaches, which in turn is the mechanism that generates non-DP dependencies, as I will propose in Chapter 7. Given these distinct mechanisms, a natural consequence would be that they display different locality signatures. So far, we have seen that the locality signature of the non-movement approach requires *pro* to evacuate *vP* via pivot movement in order to be bound by the operator. I have also argued that while true movement out of CP is impossible in Tagalog, long-distance DP dependencies can nevertheless be formed through the successive-cyclic binding mechanism.

In Chapter 6, we will see that other mechanisms for achieving locality are possible. Specifically, I show that (i) external arguments have an independently available movement operation that allows them to evacuate their thematic domains (i.e., *vP* and, as we will see *nP*), and (ii) a reduction in clausal structure allows binding *pro* without it needing to evacuate its thematic domain. These account for the DP A'-dependencies that violate the pivot-only restriction (i.e., those that target genitive-marked DPs). Subsequently in Chapter 7, I compare the locality signature of the *pro*-binding approach for DPs with the A'-movement approach for non-DPs. In particular, we will see that *vP* does not clearly inhibit the formation of non-DP dependencies in the same way that it does the formation of DP dependencies.

## Chapter 6

# Non-agreeing DP Dependencies

### 6.1 Introduction

The previous chapter introduced a proposal for analyzing the most well-known types of A'-dependencies in Tagalog. These dependencies target DP positions and conform to the observed pivot-only restriction such that the dependency target must be the pivot co-referenced by voice. Thus, I referred to these as voice-agreeing dependencies, examples of which are given in (1). We have also seen ungrammatical examples that conform to the aforementioned restriction, as in (2) where a non-pivot (i.e., genitive-marked) theme is targeted.

(1) BASIC VOICE-AGREEING DP DEPENDENCIES

- a. Nag-taním ang magsasaká ng pálay.  
AV.PFV-plant NOM farmer GEN rice.plant  
'The farmer planted rice.' Baseline Declarative
- b. Nag-pa-hingá ang magsasaká=ng [nag-taním \_\_\_ ng pálay].  
AV.PFV-CAUS-breathe NOM farmer=LK AV.PFV-plant GEN rice.plant  
'The farmer who planted rice rested.' Linker RC
- c. Si Juanita ang [nag-taním \_\_\_ ng pálay].  
NOM.P Juanita NOM AV.PFV-plant GEN rice.plant  
'The one who planted rice is Juanita.' Pseudocleft

(2) UNGRAMMATICAL VOICE-DISAGREEING DP DEPENDENCIES

- a. \*K<in>ain ng uod ang palay na [nag-taním ang magsasaká \_\_\_].  
<PFV>eat[PV] GEN worm NOM rice.plant LK AV.PFV-plant NOM farmer  
Intended: 'Worms ate the rice plants that the farmer planted.' Linker RC

- b. \*Ang palay na ito ang [nag-taním ang magsasaká \_\_\_].  
 NOM rice.plant LK PROX NOM AV.PFV-plant NOM farmer

Intended: ‘What the farmer planted was these rice plants.’

Pseudocleft

For DP dependencies, the pattern illustrated by (1-2), where (nominative-marked) pivots but not genitive-marked phrases are valid targets for A'-dependencies, is a well-established generalization, and is often taken as a given in research that deals with this area of Tagalog syntax (see Kroeger 1993; Aldridge 2002; Rackowski and Richards 2005; Kaufman 2009, among others). However, various researchers over the years have noted exceptions to this generalization, showing that *some* genitive-marked positions may also be targeted by DP A'-dependencies.<sup>1</sup>

The discussion in this chapter divides these exceptional cases into three subclasses, based on the kind of construction that the dependency is formed over. Representative examples are given in (3). In each example, the dependency gap represented by a blank corresponds to a genitive-marked DP, thus violating the pivot-only restriction. GENITIVE AGENT DEPENDENCIES (3a) target non-pivot external arguments of a clause (i.e., genitive-marked agents), SUBEXTRACTION DEPENDENCIES (3b) target the necessarily genitive-marked possessor of a pivot DP, and FREE DEPENDENCIES (3c) target DP arguments in certain reduced clause types, such as the Recent Perfective (recall Sec. 2.3.1), which lack a nominative-marked pivot argument.

(3) THREE TYPES OF NON-AGREEING DP DEPENDENCIES

- a. ?Nagta~tago ang manok na [h<in>a~habol \_\_\_ ang bata kanina].  
 AV.IMPF~hide NOM chicken LK IMPF~chase[PV] NOM child earlier

‘The chicken [that was chasing the child earlier] is hiding.’

Genitive agent dependency

- b. ?Nag-sulat ng liham ang bata=ng [bago [ang lapis \_\_\_]].  
 AV.PFV-write GEN letter NOM child=LK new NOM pencil

‘The child [who (his) pencil is new] wrote a letter.’

Subextraction dependency

- c. Lu~lutu-in ko ang isda=ng [kahu~huli lang ni Shirley \_\_\_].  
 FUT~COOK-PV 1SG.GEN NOM fish=LK RPFV~catch only GEN.P Shirley

‘I will cook the fish [that Shirley has just caught].’

Free dependency

As we will see, these subclasses show differences with respect to the relative grammaticality of the dependency, as well as the positions that can be targeted. The third subclass, the free dependency subclass, is generally judged by speakers to be unremarkable and exhibits more flexibility in which DP positions may be targeted by the dependency (i.e., internal and external arguments). The first two on the other hand, the genitive agent and subextraction dependency subclasses, tend to elicit more variable acceptability judgments from speakers, and show structural restrictions on what constitutes a valid dependency target. For example, as noted above, only external arguments—agents in (3a) and possessors in (3b)—are valid

<sup>1</sup>Recall from Chapter 4 that non-DPs relativize using different strategies that result in structurally different constructions from DP dependencies. Thus, I do not view these as true exceptions to the pivot generalization. Non-DP dependencies are discussed in Chapter 7.



targets. Table 6.1 summarizes the distribution of possible exceptional DP dependencies in relation to the impossible ones.

Table 6.1: Distribution of genitive-targeted DP A'-dependencies

| ENVIRONMENT          | POSSIBLE               | IMPOSSIBLE                                                 |
|----------------------|------------------------|------------------------------------------------------------|
| Non-pivot arguments  | ✓ Agents, Causers      | ✗ Themes                                                   |
| DP-internal          | ✓ Possessors of pivots | ✗ Complements of pivots<br>✗ DPs within <i>non</i> -pivots |
| Reduced clause types | ✓ All DP arguments     |                                                            |

To illustrate concretely, let us briefly consider the case of genitive agent dependencies, which I will discuss more thoroughly in Section 6.3. As just mentioned, these constructions are characterized by a dependency gap that corresponds to a non-pivot agent. Compare, for example the gap in the relative clause in (4b) to the corresponding position in the baseline declarative (4a). Note that this type of A'-dependency is often judged to have marginal acceptability compared to dependencies that conform to the pivot-only restriction, which are straightforwardly grammatical. Nevertheless, the marginal acceptability of genitive agent dependencies contrasts with the straightforward ill-formedness of genitive *theme* dependencies, as shown experimentally by Pizarro-Guevara and Wagers (2018). Thus, compare the genitive agent dependency in (4) to the genitive theme dependency exemplified in (5) (see also (2) above).

## (4) GRAMMATICAL VOICE-DISAGREEING AGENT DEPENDENCY

- a. I-t<in>anim **ng magsasaká** ang palay ni Barbara.  
 CV-<PFV>plant GEN farmer NOM rice.plant GEN.P Barbara  
 'The farmer planted Barbara's rice plants.' Baseline
- b. ?<Um>uwî na ang **magsasaká**=ng [i-t<in>anim ang palay ni Barbara]  
 <AV>go.home(PFV) already NOM farmer=LK CV-<PFV>plant NOM rice.plant GEN.P Barbara  
 'The farmer that planted Barbara's rice plants has gone home.' Genitive agent linker RC

## (5) UNGRAMMATICAL VOICE-DISAGREEING THEME DEPENDENCY

- a. Nag-tanim **ng palay** (**ni Barbara**) ang magsasaká.  
 AV.PFV-plant GEN rice.plant GEN.P Barbara NOM farmer  
 'The farmer planted (some of Barbara's) rice plants.' Baseline
- b. \*Na-bulok ang **palay** na [nag-tanim ang magsasaká].  
 PFV-rot NOM rice.plant LK AV.PFV-plant NOM farmer  
 Intended: 'The rice plants that the farmer planted rotted.' Genitive theme linker RC (cf. 4b)

Various instances of these voice-disagreeing A'-dependencies have been reported in the literature over the years. For example, subextraction dependencies were discussed as early as Ceña 1979 and mentioned in some shape or form by subsequent authors such as Kroeger (1993) and Nakamura (1996). Despite these constructions being known, they do not commonly factor into analyses of A'-phenomena in Tagalog

(although see Branan 2018, to be discussed further in Sec. 6.4.5). In fact, many proposals explicitly rule out dependency formation on non-pivot DPs (e.g., Aldridge 2002; Rackowski and Richards 2005). Moreover, no systematic and unified discussion or investigation into voice-disagreeing dependencies as a whole has been carried out, although some scholars such as Ceña (1979), Kroeger (1993), and Nakamura (1996), previously mentioned, have provided accounts for a subset of the relevant constructions.

The goal of this chapter is thus two-fold. First, I discuss a range of environments where  $A'$ -dependencies target a genitive-marked phrase in a construction. Taking this broad view of the landscape of voice-disagreeing DP dependencies, we will see that there are sub-generalizations that point to structural factors determining when a genitive-marked phrase can serve as an  $A'$ -dependency target. Second, I take the analysis for voice-agreeing  $A'$ -dependencies, introduced in Chapter 5, and extend it to account for the patterns we find in the disagreeing dependencies. In doing so, I show that the proposal advanced in this thesis is able to correctly account for a broader range of data than previously proposed analyses for Tagalog  $A'$ -phenomena.

In this chapter, I show that the posited locality requirement on binding *pro* can be satisfied in more ways than proposed in the previous chapter, where we saw *pro* evacuating the thematic domain via pivot movement to Spec-AgrP. On one hand, I show that there exists an alternative movement to pivot movement, which I term GENITIVE INVERSION (discussed in Sec. 6.2), that can also evacuate *pro* out of the thematic domain to satisfy the locality requirement. This movement has different characteristics from pivot movement, thus deriving the observed distributions of genitive agent dependencies (Sec. 6.3) as well as subextraction dependencies (Sec. 6.4). On the other hand, I also show that *pro* may instead remain in-situ just in case the containing structure is significantly reduced, deriving the behavior of free dependencies (Sec. 6.5).

Thus, taking this chapter with the previous one, the overall picture that I present is one of a robust locality generalization relating to the formation of DP  $A'$ -dependencies. As previously mentioned, I am unable in this thesis to provide a concrete formalization of this locality generalization. However, the more complete picture of DP  $A'$ -dependencies provided in this chapter allows us to step back and speculate on possible directions for such a formalization. I discuss this in Section 6.6.

With that said, let us begin by considering the operation of genitive inversion, which I argue provides an alternative means for *pro* to escape the thematic domain.

## 6.2 Genitive inversion and structural height

Recall that the analysis for  $A'$ -dependencies presented in Chapter 5 proposes a null pronoun *pro* which serves as a semantic variable that must be bound by an operator, subject to a locality constraint. I argued that this constraint was such that *pro* had to escape the thematic domain via an independent mechanism, and that pivot movement was such a mechanism. In the introduction, it was proposed that the same *pro* is also involved in the formation of the non-agreeing dependencies. However, considering that these dependencies target *genitive*-marked positions, we are faced with a question of how binding of *pro* despite it not having undergone pivot movement. The proposed answer is that an alternative operation, genitive inversion, is available.

In this section, it will be shown that genitive inversion applies to a very specific set of DPs: those that are (i) pronominal, (ii) genitive, (iii) external arguments. Such arguments typically surface after the semantic head of an XP, but may undergo genitive inversion to instead precede the head, appearing in the oblique form. The alternation is schematized in (6).

- (6) GENITIVE INVERSION (SCHEMATIC)  
 [ (PL/NEG) N/V  $\boxed{pro_{GEN}}$  XP ... ]  $\rightarrow$  [  $\boxed{pro_{OBL=ng}}$  (PL/NEG) N/V XP ... ]

I analyze this process of inversion as movement and propose that it allows satisfaction of the locality requirement on binding *pro*. This broadens the range of possible DP-targeted A'-dependencies from what we have seen in the previous chapter, but crucially in a restricted way. Specifically, because genitive inversion is only possible with external argument pronouns, as sketched in (7), we derive that the broadened range of DP A'-dependencies only includes ones that target external arguments (i.e., the genitive agent and subextraction dependencies).<sup>2</sup>

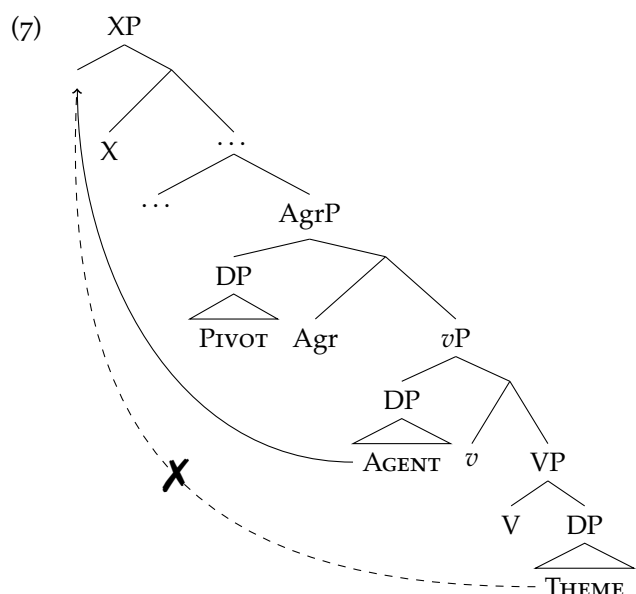

In this section, I provide a description of genitive inversion, and argue that the pre-head pronoun occupies a syntactically high position, specifically preceding functional elements such as negation and the plural marker (also shown in (6)). While a full analysis of this phenomenon ultimately lies outside the scope of this thesis, I provide some discussion of potential approaches that can be explored in future work.

### 6.2.1 Overview

To begin, I describe the process in nominal constructions, where it is most productive. Recall that possessors (or external arguments more generally) of nouns are marked genitive. Example (8) shows four different types of possessors: a pronoun, a demonstrative (which can have a third person pronoun-like use), a proper name, and a common noun. As we can see, these appear post-nominally.

<sup>2</sup>This range will be expanded again when we consider free dependencies in Sec. 6.5

- (8) ang bahay {**mo** /**nito** /**ni** **Chester**/**ng propesor**} sa Davao  
 NOM house 2SG.GEN GEN.PROX GEN.P Chester GEN professor OBL Davao  
 ‘{your/this one’s/Chester’s/the professor’s} house in Davao’

However, when the possessor is pronominal, it may instead surface *pre-nominally* and in the (bare) *oblique* form; a linker also mediates between the now-initial pronoun and the head noun, as (9a) illustrates. This kind of inversion is possible but marked with proper names, and is generally ill-formed with demonstratives and other full nouns, as we see in (9b-d). See also Ramos 1971, §10.1 and Schachter and Otnes 1972, §3.20.<sup>3</sup> A schematized description of this alternation is given in (10).

(9) GENITIVE INVERSION IN NOMINAL CONSTRUCTIONS

- a. ang **iyo=ng** bahay sa Davao  
 NOM 2SG.OBL=LK house OBL Davao  
 ‘your house in Davao’ Pronoun
- b. \*ang {**nito** /**dito** }=**ng** bahay sa Davao  
 NOM GEN.PROX PROX.OBL =LK house OBL Davao  
 Intended: ‘{this one’s/their<sub>SG</sub>} house in Davao’ Demonstrative
- c. ?ang **kay Chester na** bahay sa Davao  
 NOM OBL.P Chester LK house OBL Davao  
 ‘Chester’s house in Davao’ Proper Name
- d. \*ang **sa propesor na** bahay sa Davao  
 NOM OBL professor LK house OBL Davao  
 Intended: ‘the professor’s house in Davao’ Common Noun

(10) GENITIVE INVERSION (SCHEMATIC)

$$[ N/V \boxed{pro_{GEN}} XP \dots ] \rightarrow [ \boxed{pro_{OBL=ng}} N/V XP \dots ]$$

We also observe parallel behavior in verbal constructions, but little work over the years appears to have been done on this, with the notable exceptions of Culwell-Kanarek 2005 and Schachter and Otnes 1972, §5.25.<sup>4</sup> The patterns are mostly similar to what we have just seen for the nominal domain, but are more restricted in certain ways.

As in nominal constructions, the process applies to genitive pronominal external arguments across different clause types. Three pairs of examples showing this are given below, using different forms of *bili* ‘buy’: (11) shows a PV monotransitive, (12) shows an LV low applicative/double object construction, and (13) shows a CV causative.

<sup>3</sup>These authors simply present genitive inversion in nominal constructions as one of the possible strategies for possessive modification (i.e., it is not treated as a transformation). Additionally, Schachter and Otnes state that examples like (9d), where a common noun has undergone genitive inversion, are grammatical, contra what is reported here from my own elicitation work. Interestingly, Ramos only mentions the construction applying to pronouns, and does not provide evidence (positive or negative) regarding other kinds of DPs.

<sup>4</sup>This situation may be due in part to the fact that genitive inversion is comparatively less common or productive in verbal constructions.

## (11) PV TRANSITIVE

- a. Bi~bilh-in {niya /nito /ni Cheska/ng bata} ang tinapay para sa kaibigan  
 FUT~buy-PV 3SG.GEN GEN.PROX GEN.P Cheska GEN child NOM bread for OBL friend  
 mo.  
 2SG.GEN

'{The child/this one/Cheska/They<sub>SG</sub>} will buy the bread for your friend.' Baseline

- b. **Kanya=ng** bi~bilh-in ang tinapay para sa kaibigan mo.  
 3SG.OBL=LK FUT~buy-PV NOM bread for OBL friend 2SG.GEN  
 'They<sub>SG</sub> will buy bread for your friend.'

## (12) LV LOW APPLICATIVE

- a. Bi~bilh-an {niya /nito /ni Cheska/ng bata} ng tinapay ang kaibigan mo.  
 FUT~buy-LV 3SG.GEN GEN.PROX GEN.P Cheska GEN child GEN bread NOM friend 2SG.GEN  
 '{The child/this one/Cheska/They<sub>SG</sub>} will buy bread for your friend.' Baseline

- b. **Kanya=ng** bi~bilh-an ng tinapay ang kaibigan mo.  
 3SG.OBL=LK FUT~buy-LV GEN bread NOM friend 2SG.GEN  
 'They<sub>SG</sub> will buy bread for your friend.'

## (13) CV CAUSATIVE

- a. I-pa~pa-bili {niya /nito /ni Cheska/ng bata} sa kapatid mo ang tinapay.  
 CV-FUT~CAUS-buy 3SG.GEN GEN.PROX GEN.P Cheska GEN child OBL sibling 2SG.GEN NOM bread  
 '{The child/this one/Cheska/They<sub>SG</sub>} will have your sibling buy the bread.' Baseline

- b. **Kanya=ng** i-pa~pa-bili sa kapatid mo ang tinapay.  
 3SG.OBL=LK CV-FUT~CAUS-buy OBL sibling 2SG.GEN NOM bread  
 'They<sub>SG</sub> will have your sibling buy the bread.'

One difference we find in the verbal domain is that inversion is strictly limited to pronouns; proper names cannot invert. Compare the examples in (14) with the nominal example (9c). The examples below also show ungrammatical common noun and demonstrative inversion for completeness. Note also that the proper name and common noun examples are ungrammatical regardless of how they are marked (oblique *kay/sa* or genitive *ni/ng*).

## (14) GENITIVE INVERSION IS IMPOSSIBLE WITH NON-PRONOMINAL ARGUMENTS

- a. \*{**Dito** /(Kay) Cheska/(Sa) bata}=ng bi~bilh-in ang tinapay para sa kaibigan mo.  
 PROX.OBL OBL.P Cheska OBL child=LK FUT~buy-PV NOM bread for OBL friend 2SG.GEN

Intended: '{This one/The child/Cheska} will buy the bread for your friend.' (cf. 11a)

- b. \*{**Dito** /(**Kay**) **Cheska**/(**Sa**) **bata**}=ng bi~bilh-an ng tinapay ang kaibigan mo.  
 PROX.OBL OBL.P Cheska OBL child =LK FUT~buy-LV GEN bread NOM friend 2SG.GEN  
 Intended: ‘{This one/The child/Cheska} will buy bread for your friend.’ (cf. 12a)
- c. \*{**Dito** /(**Kay**) **Cheska**/(**Sa**) **bata**}=ng i-pa~pa-bili sa kapatid mo ang tinapay.  
 PROX.OBL OBL.P Cheska OBL child =LK CV-FUT~CAUS-buy OBL sibling 2SG.GEN NOM bread  
 Intended: ‘{This one/The child/Cheska} will have your sibling buy the bread.’ (cf. 13a)

Genitive inversion also interacts with the Tagalog voice system. As we see in (15), pivots cannot undergo inversion, even if they are pronominal external arguments. Note that this example shows the restriction for a transitive agent (with *bibili* ‘will buy’) and for a causer (with *magpapabili* ‘will have something bought’). Furthermore, the inversion is ungrammatical regardless of the form of the pronoun.

(15) NOMINATIVE PRONOUNS CANNOT UNDERGO INVERSION

- a. {Bi~bili /Mag-pa~pa-bili} **siya** ng tinapay para sa kaibigan mo.  
 FUT~buy[AV] AV-FUT~CAUS-buy 3SG.NOM GEN bread for OBL friend 2SG.GEN  
 ‘They<sub>SG</sub> will {buy bread / have bread bought} for your friend.’ Baseline
- b. \*{**Siya** /**Kanya**}=ng {bi~bili /mag-pa~pa-bili} ng tinapay para sa kaibigan mo.  
 3SG.NOM 3SG.OBL =LK FUT~buy[AV] AV-FUT~CAUS-buy GEN bread for OBL friend 2SG.GEN  
 Intended: ‘They<sub>SG</sub> will {buy bread / have bread bought} for your friend.’

It is also worth noting that genitive inversion is also possible in gerunds. This is perhaps not so surprising given that we have seen that inversion can apply to both verbal and nominal constructions. The example in (16) shows both a transitive (*pagbili*) and a causative (*pagpapabili*) gerund.<sup>5</sup>

(16) GENITIVE INVERSION IN GERUNDS

- a. ang {pag-bili/pag-pa~pa-bili} **niya** ng tinapay para sa kaibigan mo  
 NOM pag-buy pag-RED~CAUS-buy 3SG.GEN GEN bread for OBL friend 2SG.GEN  
 ‘Their<sub>SG</sub> {buying of bread / having bread bought} for your friend.’ Baseline
- b. ang **kanya=ng** {pag-bili/pag-pa~pa-bili} ng tinapay para sa kaibigan mo  
 NOM 3SG.OBL=LK pag-buy pag-RED~CAUS-buy GEN bread for OBL friend 2SG.GEN  
 ‘Their<sub>SG</sub> {buying of bread / having bread bought} for your friend.’

## 6.2.2 Genitive inversion and other fronting constructions

The fact that genitive inversion fronts an element that typically follows the semantic head of a construction is reminiscent of what we see with other clause-level operations which have a semantic or information-structural effect. Despite this similarity, speakers do not report such intuitions, and instead tend to say

<sup>5</sup>Here, I include the behavior of genitive inversion with gerunds for completeness. Given the claim made at the beginning of this section about the role of genitive inversion in A'-dependency formation, the data presented here would suggest that gerunds should allow subextraction (Sec. 6.4). However, the data relating to this remains equivocal, and it is not clear if the arguments of gerunds can (marginally) be targeted by an A'-dependency, or if we find similar internal/external-argument asymmetries for such targeting.

that constructions with inversion sound more formal or more poetic than the non-inverted counterpart, especially with verbal constructions. The more formal register of inversion may lead some speakers to reject these constructions, but naturally occurring examples can be found, such as those provided in (17), one from a Tagalog Bible translation, and one from a memo issued to an association of Filipino (Tagalog) teachers.

- (17) a. Sapagka't **ami[n]=ng** na-kita ang **kaniya=ng** bituin sa silanganan  
 because 1PL.EXCL.OBL=LK NVOL.PFV-see[PV] NOM 3SG.OBL=LK star OBL east  
 'For we saw his star in the east' Matt. 2:2 (Ang Biblia 1978)<sup>6</sup>
- b. Dahilan sa **inyo=ng** pag-suporta at pag-kalinga, **ami[n]=ng** na-i-sa-gawa  
 reason OBL 2PL.OBL=LK pag-support and pag-care 1PL.EXCL.OBL=LK NVOL.PFV-CV-sa-do  
 noo[n]=ng tao[n]=ng 2014...  
 that.time=LK year=LK 2014  
 'Because of your support and care, we were able to implement in the year 2014...' Web<sup>7</sup>

Note in particular that despite the appearance of an oblique-marked element pre-verbally, genitive inversion is distinct from focus fronting (i.e., non-DP focus), not only in its information structure as just discussed, but also in its surface structure and the type of XP it targets. With genitive inversion, the target is a genitive external argument pronoun, which, when fronted, must surface as a bare oblique pronoun and be followed by the linker. With focus fronting on the other hand, the target is a non-DP that need not be pronominal, which, when fronted, surfaces with the same marking and does not appear with the linker. Table 6.2 summarizes the differences between these constructions.

Table 6.2: Differences between genitive inversion and focus fronting

|             | GENITIVE INVERSION                                              | FOCUS FRONTING                                                    |
|-------------|-----------------------------------------------------------------|-------------------------------------------------------------------|
| TARGET TYPE | Pronominal external arguments                                   | Various non-DPs (pronominal and not)                              |
| MARKING     | GEN → Bare OBL<br>(e.g., 3SG <i>niya</i> → <i>(*sa) kanya</i> ) | No change<br>(e.g., 3SG <i>*(sa) kanya</i> → <i>*(sa) kanya</i> ) |
| LINKER      | Obligatory                                                      | Ungrammatical                                                     |

Thus, we see that there is no overlap between focus fronting and genitive inversion, other than the fact that both constructions involve an oblique-marked expression linearly preceding the semantic head of a phrase. I illustrate this non-overlap with concrete examples. In (18), we see that an oblique-marked argument, in this case a causee, can be focus fronted, regardless of whether it is pronominal (i.e., *sa akin*) or a full nominal expression (i.e., *sa bata*). Notice also that there is no change in marking on the causee between the fronted and non-fronted examples, (18b) vs (18a). In contrast, genitive inversion of this same argument is ungrammatical, as (18c) shows.

<sup>6</sup><https://www.biblegateway.com/passage/?search=Mateo+2%3A2&version=ABTAG1978>.

<sup>7</sup>Alday to Diosdado M. San Antonio, memorandum, June 24, 2015, in *Issuances of the Department of Education Region IV-A (CAL-ABARZON)*, <http://depedcalabarzon.ph/wp-content/uploads/2015/06/Memorandum-6726.pdf>.

## (18) FOCUS FRONTING VS GENITIVE INVERSION OF OBLIQUE CAUSEE

- a. I-pa~pa-bili ni Tomas sa {akin /bata} ang tinapay.  
 CV-FUT~CAUS-buy GEN.P Tomas OBL 1SG.OBL child NOM bread  
 ‘Tomas will have {me/the child} buy the bread.’ Baseline
- b. Sa {akin /bata} i-pa~pa-bili ni Tomas ang tinapay.  
 OBL 1SG.OBL child CV-FUT~CAUS-buy GEN.P Tomas NOM bread  
 ‘It’s {me/the child} that Tomas will have buy the bread.’ ✓Focus Fronting
- c. \*Aki[n]=ng i-pa~pa-bili ni Tomas ang tinapay.  
 1SG.OBL=LK CV-FUT~CAUS-buy GEN.P Tomas NOM bread  
 Intended: ‘Tomas will have me buy the bread.’ \*Genitive Inversion

Compare now the behavior of oblique causees that we have just seen with that of non-pivot (i.e., genitive) causers shown in (19).<sup>8</sup> We see in (19b) that the causer cannot undergo focus fronting, regardless of the form it takes when fronted in this way. This ungrammaticality is expected from previous discussion in 4.1.2 establishing that DPs in general cannot undergo focus fronting. On the other hand, (19c) shows that the causer may undergo genitive inversion (and as we will see later, pseudoclefting). We thus see that the distributions of focus fronting and genitive inversion do not overlap.

## (19) FOCUS FRONTING VS GENITIVE INVERSION OF NON-PIVOT AGENT

- a. I-pa~pa-bili niya sa bata ang tinapay.  
 CV-FUT~CAUS-buy 3SG.GEN OBL child NOM bread  
 ‘They<sub>SG</sub> will have the child buy the bread.’ Baseline
- b. \*{(Sa) Kanya /Niya } i-pa~pa-bili sa bata ang tinapay.  
 OBL 3SG.OBL 3SG.GEN CV-FUT~CAUS-buy OBL child NOM bread  
 Intended: ‘It’s them<sub>SG</sub> that will have the child buy the bread.’ \*Focus Fronting
- c. Kanya=ng i-pa~pa-bili sa bata ang tinapay.  
 3SG.OBL=LK CV-FUT~CAUS-buy OBL child NOM bread  
 ‘They<sub>SG</sub> will have the child buy the bread.’ ✓Genitive Inversion

## 6.2.3 Inversion and external arguments

So far, I have established some basic properties of genitive inversion. In particular, the grammatical examples of inversion we have seen so far involve arguments satisfying three properties listed in (20).

<sup>8</sup>Similar data was also shown previously in (13).



## (20) CRITERIA FOR GENITIVE INVERSION

An argument may undergo genitive inversion if it is:

- a. pronominal,
- b. marked genitive, and
- c. an external argument.

Given this, a natural question to ask is which of these three properties are necessary for an argument to be eligible for genitive inversion. We have seen, for example, that pronounhood (20a) is necessary, as genitive external arguments that are *non*-pronominal cannot be inverted, with some exceptions (recall (9b-d) and (14)). On the other hand, we have also seen to some extent that genitive marking (20b) is necessary, as pronominal external arguments that are *nominative* cannot be inverted (recall (15)). Furthermore *oblique* arguments like non-pivot causees in (18) cannot be inverted either. What about external argument status (20c)? We will see here that this question is not a trivial one to answer fully, as genitive pronouns are necessarily external arguments in Tagalog. Thus, it is not possible to isolate this property from the others. We turn to a discussion of the issue here.

First, we see that internal arguments and adjuncts that are non-DPs cannot undergo genitive inversion. This is unsurprising, since oblique-marked pronouns must appear with the oblique-marker *sa* in argument and adjunct positions. In other words, they are contained within a PP, following the discussion in Section 2.4.2. Examples are given in (21-24) showing different types of oblique-marked arguments and adjuncts in a number of environments. We also saw an example with an oblique causee in (18).

## (21) AV CLAUSE

- a. Ma-ki~kinig siya    **sa inyo.**  
 AV-FUT~listen 3SG.NOM OBL 2PL.OBL

'They<sub>SG</sub> will listen to you.'

Baseline

- b.\* (Sa) **Inyo=ng** ma-ki~kinig siya.  
 OBL 2PL.OBL=LK AV-FUT~listen 3SG.NOM

Intended: 'They<sub>SG</sub> will listen to you.'

\*Non-DP Inversion

## (22) PV CLAUSE

- a. Bi~bilh-in ng mga kusinero ang mga gulay    **sa amin.**  
 FUT~buy-PV GEN PL cook    NOM PL vegetable OBL 1PL.EXCL.OBL

'The chefs will buy the vegetables from us.'

Baseline

- b.\* (Sa) **Ami[n]=ng** bi~bilh-in ng mga kusinero ang mga gulay.  
 OBL 1PL.EXCL.OBL=LK FUT~buy-PV GEN PL cook    NOM PL vegetable

Intended: 'The chefs will buy the vegetables from us.'

\*Non-DP Inversion

## (23) GERUND

- a. ang pa-ki~kinig niya **sa inyo**  
 NOM *pa-RED~listen* 3SG.GEN OBL 2PL.OBL  
 ‘their<sub>SG</sub> listening to you’ Baseline
- b. \*ang (sa) **inyo=ng** pa-ki~kinig niya  
 NOM OBL 2PL.OBL=LK *pa-RED~listen* 3SG.GEN  
 Intended: ‘their<sub>SG</sub> listening to you’ \*Non-DP Inversion

## (24) NOMINAL

- a. ang gálit mo **sa akin**  
 NOM anger 2SG.GEN OBL 1SG.OBL  
 ‘your anger at me’ Baseline
- b. \*ang (sa) **aki[n]=ng** gálit mo  
 NOM OBL 1SG.OBL=LK anger 2SG.GEN  
 Intended: ‘your anger at me’ \*Non-DP Inversion

On the other hand, DP internal arguments, specifically themes, present a more complicated picture due to patterns of differential object marking and restrictions on their definiteness, as previously mentioned in Section 2.4.3. Most relevant for our current purposes is the fact that genitive personal pronouns cannot occur in theme position, as (25) shows. We see in (25a-b) that definite non-pivot themes are possible in some contexts, but they must be marked oblique.<sup>9</sup> The restriction is stronger in unmarked verb-initial clauses, where definite themes are generally ungrammatical, even when oblique, as (25c) shows.<sup>10</sup> Since pronominal themes cannot be genitive-marked, it should be unsurprising that they cannot undergo genitive inversion, as (26) illustrates.

## (25) GENITIVE THEMES CANNOT BE GENITIVE PRONOUNS

- a. ang mga manunulát na [mag-i~imbíta {\*nila /sa kanila }]  
 NOM PL writer LK AV-FUT~invite 3PL.GEN OBL 3PL.OBL  
 ‘the writers who will invite them’ Relative clause
- b. ang pag-i~imbíta namin {\*nila /sa kanila }  
 NOM *pag-RED~invite* 1PL.EXCL.GEN 3PL.GEN OBL 3PL.OBL  
 ‘our inviting them’ Gerund
- c. Mag-i~imbíta kami {ng mga kaibigan/\*nila /\*sa kanila }.  
 AV-FUT~invite 1PL.EXCL.NOM GEN PL friend 3PL.GEN OBL 3PL.OBL  
 ‘We will invite {friends/\*them/\*them}.’ Verb-initial declarative clause

<sup>9</sup>The environments in which this kind of differential object marking are possible appear to be AV clauses with agent-targeted A'-dependencies as well as verbal constructions that do not assign nominative Case (e.g., gerunds, recent perfective clauses).

<sup>10</sup>Although see Sabbagh 2016 for detailed discussion of cases where genitive non-pronominal themes are specific indefinites.

## (26) UNGRAMMATICAL GENITIVE INVERSION OF THEMES

- a. \*ang mga manunulát na [**kanila=ng** mag-i~imbita]  
 NOM PL writer LK 3PL.OBL=LK AV-FUT~invite  
 Intended: 'the writers who will invite them' Relative Clause
- b. \*ang **kanila=ng** pag-i~imbita namin  
 NOM 3PL.OBL=LK pag-RED~invite 1PL.EXCL.GEN  
 Intended: 'our inviting them' Gerund
- c. \***Kanila=ng** mag-i~imbita kami.  
 3PL.OBL=LK AV-FUT~invite 1PL.EXCL.NOM  
 Intended: 'We will invite them.' Unmarked verb-initial Clause

Note also that while demonstratives, which have pronoun-like uses, can appear as genitive themes,<sup>11</sup> as (27) shows, we have already seen that they cannot invert, even if they are the external argument. Therefore, the ill-formedness of genitive inversion with demonstrative themes shown in (28) should be unsurprising.

## (27) GENITIVE THEME DEMONSTRATIVES

- a. B<um>ili ang mga magulang ko **niyan**.  
 <AV>buy(PFV) NOM PL parent 1SG.GEN GEN.MED  
 'My parents bought {some/one} of that.' Unmarked verb-initial Clause
- b. ang mga guro=ng [**b<um>ili niyan**]  
 NOM PL teacher=LK <AV>buy(PFV) GEN.MED  
 'the teachers who bought {that/it}' Relative Clause

## (28) GENITIVE THEME DEMONSTRATIVES CANNOT INVERT

- a. \*{Niyan /Diyan }=ng b<um>ili ang mga magulang ko.  
 GEN.MED OBL.MED =LK <AV>buy(PFV) NOM PL parent 1SG.GEN  
 Intended: 'My parents bought {some/one} of that.' Unmarked verb-initial Clause
- b. \*ang mga guro=ng [{niyan /diyan }=ng b<um>ili]  
 NOM PL teacher=LK GEN.MED OBL.MED =LK <AV>buy(PFV)  
 Intended: 'the teachers who bought {that/it}' Relative Clause

Thus, while we have seen that inversion only applies to genitive pronouns, we see that only external arguments may be genitive pronouns. Consequently, we cannot definitively rule out or confirm the role

<sup>11</sup>Although note the partitive or kind reading in the verb-initial example (27a), which is likely also tied to the definiteness restriction on genitive themes, since the reading disappears in the relevant A'-dependency construction, as in (i).

(i) Ang mga magulang ko [ang b<um>ili niyan].  
 NOM PL parent 1SG.GEN NOM <AV>buy(PFV) MED.GEN  
 '[The ones who bought that] were my parents.'

of structural height in directly determining eligibility for genitive inversion. What is clear, however, is that external arguments are syntactically privileged in some way that allows genitive inversion to occur, either directly or by virtue of allowing genitive pronoun forms. This fact is significant, as it mirrors the distribution of possible targets for the first two classes of non-agreeing DP dependencies discussed in this chapter.

Having discussed the basic behavior and distribution of genitive inversion, I now turn to its structure. Specifically, I will consider the question of the syntactic position that the inverted pronoun occupies.

### 6.2.4 The structure of inversion

As we have seen, genitive inversion causes a normally post-verbal or post-nominal genitive pronoun to surface pre-verbally or pre-nominally. Here, we consider the structural position occupied by the pronoun when it surfaces pre-verbally or pre-nominally. Following the claim at the beginning of this section, I argue that the pronoun has moved to a higher position in the extended projection of the relevant phrase.

The clearest evidence we have that the inverted pronoun occupies this higher position is the fact that it must precede certain heads from the extended nominal and verbal projections. Specifically, inverted pronouns appear before the plural marker *mga*, as in (29a-b), and the negator *hindi*, as in (29b-c).<sup>12</sup> In (30), we see that reversing the relative order of these elements is ungrammatical.

#### (29) INVERTED PRONOUNS PRECEDE PLURAL MARKER AND NEGATION

- a. Ma-ba~bait ang **ami[n]=ng mga** guro dito.  
 ADJ-PL~nice NOM 1PL.EXCL.OBL=LK PL teacher OBL.PROX  
 ‘Our teachers are nice.’ Nominal
- b. ...s<in>a~sabi ni Duterte sa **kanya=ng mga** talumpati [na **kanya=ng hindi** pa~payag-an  
 IMPF~say[PV] GEN.P Duterte OBL 3SG.OBL=LK PL speech LK 3SG.OBL=LK NEG FUT~allow-LV  
 ang pag-renew ng ABS-CBN]...  
 NOM pag-renew GEN ABS-CBN  
 ‘...Duterte has been saying in his speeches that he would not allow the renewal of ABS-CBN...’  
Nominal Phrase + Verbal Clause (Web<sup>13</sup>)
- c. ...at s<in>a~samantala nila ang **ati[n]=ng hindi** pagka~ka-sundo...  
 and IMPF~take.advantage[PV] 3PL.GEN NOM 1PL.INCL.OBL=LK NEG pagka~RED-agree  
 ‘...and they take advantage of our not agreeing (with each other)...’ Gerund (Web<sup>14</sup>)

<sup>12</sup>Culwell-Kanarek (2005) claims that, in the verbal domain, the opposite is true: negation blocks genitive inversion. He provides an example (his (10b)) that he marks as marginal, which are similar to the ones I provide here, and concludes that pronouns cannot invert past negation. Similarly, Schachter and Otones (1972, p.381) report that the co-occurrence negation and genitive inversion is ungrammatical, regardless of the relative positions of the two. While I have also encountered some degree of marginal judgments with these constructions, some speakers accept the constructions, and I have also provided naturally occurring examples in (29), which were found online from Tagalog sources (a tabloid and old congressional records). To my knowledge, the interaction of the plural marker and genitive inversion is less uncertain and conforms to the data I provide here.

<sup>13</sup>RPFV, “Wala namang balak gumanti! Duterte inis lang sa ABS-CBN – Panelo,” *Abante TNT*, n.d., accessed October 24, 2019, <http://tnt.abante.com.ph/wala-namang-balak-gumanti-duterte-inis-lang-sa-abs-cbn-panelo/>.

<sup>14</sup>Philippines. 4 Cong. Rec.: Senate 2037 (1959), [https://books.google.ca/books?id=gHj\\_SJPYvX0C&pg=PA2164#v=onepage&q=%22ating%20hindi%22&f=false](https://books.google.ca/books?id=gHj_SJPYvX0C&pg=PA2164#v=onepage&q=%22ating%20hindi%22&f=false)

## (30) INVERTED PRONOUNS CANNOT FOLLOW PLURAL MARKER AND NEGATION

- a. \*Ma-ba~bait ang **mga ami[n]=ng** guro dito.  
 ADJ-PL~nice NOM PL 1PL.EXCL.OBL=LK teacher OBL.PROX  
 Intended: ‘Our teachers are nice.’ (cf. 29a)
- b. \*...sa **mga kanya=ng** talumpati na **hindi kanya=ng** pa~payag-an...  
 OBL PL 3SG.OBL=LK speech LK NEG 3SG.OBL=LK FUT~allow-LV  
 Intended: ‘...in his speeches that he would not allow...’<sup>15</sup> (cf. 29b)
- c. \*...at s<in>a~samantala nila ang **hindi ati[n]=ng** pagka~ka-sundo...  
 and IMPF~take.advantage[PV] 3PL.GEN NOM NEG 1PL.INCL.OBL=LK pagka~RED-agree  
 Intended: ‘...and they take advantage of our not agreeing (with each other)...’ (cf. 29c)

If we assume that the plural marker *mga* and the negator *hindi* both c-command the base positions of external arguments (i.e., Spec-*nP* and Spec-*vP*), then the fact that these arguments precede the relevant functional heads when inverted suggests that the arguments are no longer in their base positions. For concreteness, I assume that *mga* instantiates Num<sup>0</sup> and *hindi* instantiates Neg<sup>0</sup>.<sup>16</sup>

On the other hand, we can also ask how high the inverted pronouns are in the structure. This turns out to be easier to ascertain in verbal environments, where we see that genitive inversion occurs below clause-level operations such as DP relativization and *ay*-inversion, as in (31).

## (31) INVERSION OCCURS UNDER CERTAIN CLAUSE-LEVEL OPERATIONS

- a. **Ati[n]=ng** ma-ki~kita sa gubat ang mga tarsier.  
 1PL.INCL.OBL=LK NVOL-FUT~see[PV] OBL jungle NOM PL tarsier  
 ‘We will see the tarsiers in the jungle.’ Baseline
- b. Mag-ingat tayo sa mga tarsier na **ati[n]=ng** ma-ki~kita sa gubat  
 AV-be.careful 1PL.INCL.NOM OBL PL tarsier LK 1PL.INCL.OBL=LK NVOL-FUT~see[PV] OBL jungle  
 ‘Let’s be careful of the tarsiers that we will see in the jungle.’ DP Relative Clause
- c. Ang mga tarsier ay **ati[n]=ng** ma-ki~kita sa gubat.  
 NOM PL tarsier TOP 1PL.INCL.OBL=LK NVOL-FUT~see[PV] OBL jungle  
 ‘As for the tarsiers, we will see them in the jungle.’ *Ay*-inversion

The relatively low position of the inverted pronoun in the left periphery of the clause can also be seen in the placement behavior of second-position clitics, which was previously discussed to be an indicator of structure (Sec. 4.2.3). We see in (32) that the inverted pronoun (italicized) serves as a host

<sup>15</sup>This example has been shortened from its grammatical counterpart to show only the crucial differences. Furthermore, it is ungrammatical if at least one instance of *kanyang* follows either *mga* or *hindi*.

<sup>16</sup>There is some evidence that, within Rizzi’s (1997) articulated left periphery proposal, *hindi* (or negation in general) is associated with Fin<sup>0</sup> or FinP. Most prominently, sentential negation appears consistently clause-initially, linearly preceded only by genitive inversion (as we see here), and constituents associated with left-peripheral operations (e.g., focus, topic). The form of the negator also shows sensitivity to clause type. We have *huwag* in negative imperatives, the negative existential verb *wala*, and in certain reduced clauses like recent perfective, negation is impossible. Finally, negation also licenses the aspectless form of non-volitional (or ability/involuntary action) verbs to produce anti-ability attributions (e.g., *\*(hindi) makita* ‘can’t see’).

for second-position clitic pronouns. In this regard, genitive inversion patterns with focus fronting of non-DPs (33), and again contrasts with other fronting processes that do not attract pronominal clitics, such as *ay*-inversion in (34).

## (32) INVERTED AGENT PRONOUN SERVES AS CLITIC HOST

- a. Kaya't *akin* **siya=ng** a~akit-in...  
 therefore 1SG.OBL 3SG.NOM=LK FUT~entice-PV  
 'Therefore I will entice them<sub>SG...</sub>' Hosea 2:14 (Ang Biblia 2001)<sup>17</sup>
- b. ...na-banggit ni Maris Racal nang *amin* **siya=ng**  
 NVOL.PFV-mention[PFV] GEN.P Maris Racal back.when 1PL.EXCL.OBL 3SG.NOM=LK  
 na-ka-panayam sa Tonight with Boy Abunda na...  
 NVOL.PFV-COM-interview OBL *Tonight with Boy Abunda* LK  
 '...Maris Racal mentioned when we got to interview her on *Tonight with Boy Abunda* that...' Web<sup>18</sup>

## (33) PRONOUNS ENCLITICIZE TO FOCUSED NON-DPs

- Sa gubat {**natin**} ma-ki~kita {**\*natin**} ang mga tarsier.  
 OBL jungle 1PL.INCL.GEN NVOL-FUT~see[PV] 1PL.INCL.GEN NOM PL tarsier  
 'It's in the jungle that we will see the tarsiers.'

(34) CLITIC BEHAVIOR WITH *ay*-INVERSION

- Sa gubat {**\*natin**} ay ma-ki~kita {**natin**} ang mga tarsier.  
 OBL jungle 1PL.INCL.GEN TOP NVOL-FUT~see[PV] 1PL.INCL.GEN NOM PL tarsier  
 'In the jungle, we will see the tarsiers.'<sup>19</sup>

Interestingly, simultaneous non-DP focus fronting and genitive inversion appears to be degraded, even for speakers who accept genitive inversion readily. Both relative orders of the fronted non-DP and the inverted pronoun are ungrammatical, although there may be a slight preference for the pronoun to follow the focus constituent.<sup>20</sup> The fact that inversion is possible with pseudoclefts (i.e., DP focus), as in (36), suggests that the ungrammaticality of (35) is not information- or discourse-structural in nature. Rather this ungrammaticality likely has a syntactic explanation, following the discussion in Chapter 4 on the structurally distinct natures of focus fronting and pseudoclefts. Most straightforwardly, we might posit that the inverted pronoun and the focus constituent occupy the same syntactic position.

- (35) {**\*Ati[n]=ng**} sa gubat {**\*<sup>2</sup>ati[n]=ng**} ma-ki~kita ang mga tarsier.  
 1PL.INCL.OBL=LK OBL jungle 1PL.INCL.OBL=LK NVOL-FUT~see[PV] NOM PL tarsier  
 Intended: 'It's in the jungle that will we see the tarsiers.'

<sup>17</sup><https://www.biblegateway.com/passage/?search=Hosea+2%3A14&version=ABTAG2001>.

<sup>18</sup>Boy Abunda, "Inigo: 'I was heart broken as well!'," *Diaryo Bomba*, September 3, 2019, <https://diaryobomba.com/celebrities/inigo-i-was-heartbroken-as-well/>.

<sup>19</sup>The sentence with *natin* preceding *ay* is grammatical, but must mean 'In *our* jungles, the tarsiers will be seen' (i.e., the pronoun must be interpreted as being part of the topic constituent).

<sup>20</sup>This may be because when the fronted non-DP (i.e., *sa gubat*) is clause-initial, it can be reinterpreted more easily as a prosodic topic (i.e., 'In the jungle, we will see the tarsiers').

- (36) Ang mga tarsier ang **ati[n]=ng** ma-ki~kita sa gubat.  
 NOM PL tarsier NOM 1PL.INCL.OBL=LK NVOL-FUT~see[PV] OBL jungle  
 ‘What will we see in the jungle are the tarsiers.’

In nominal constructions, the exact position of the inverted possessor is harder to pinpoint, as not many types of phrases can appear in the Tagalog extended nominal projection, unlike what we see with the left-peripheral field of a clause (*cf.* *ay*-topics). In fact, other than the inverted pronoun, few things may linearly precede the plural marker. We do see in (37) that adjectives may precede *mga*, although such a word order is somewhat marked, and it is more typical for adjectives to follow *mga*. Nevertheless, this marginal pre-*mga* position for adjectives contrasts with the straightforwardly ungrammatical position preceding the inverted possessor that (37) also shows. This again suggests that the pronoun is syntactically high within DP.<sup>21</sup>

- (37) INVERTED POSSESSOR PRONOUNS PRECEDE ADJECTIVES  
 Naka-lagay sa bookshelf [ang {**\*ma-bi~bigat na**} aki[n]=ng {**?ma-bi~bigat na**} mga  
 STAT-put OBL bookshelf NOM 1SG.OBL=LK PL  
 {**ma-bi~bigat na**} libro].  
 ADJ-PL~heavy LK book  
 ‘My heavy books are placed on the shelf.’

The data that we have seen so far puts the inverted pronoun in a high position clearly above *vP* and *nP*, which I assume introduce external arguments in their respective specifiers. We also see that, at least within verbal constructions, the inverted pronoun occupies a low enough position in the clause that it remains within the clitic placement domain of clausemate clitic pronouns. The positions occupied by inverted pronouns are schematized in (38).

- (38) RELATIVE POSITION OF INVERTED PRONOUN
- a. C > *Ay*-topic > *pro*<sub>OBL</sub> > Clitics > LK > NEG > Verb (=Infl+Agr+v+V) Verbal environments
- b. D > *pro*<sub>OBL</sub> > LK > {PL, Adj} > N Nominal environments

<sup>21</sup>Inverted possessors, like inverted agents, function as clitic hosts. However, this behavior is only observable with clitics associated with higher positions. The examples in (i) show the mirative(-like) particle *pala* and the question particle *ba*. These clitics almost certainly originate *outside* of the bracketed DPs. Furthermore, Tagalog clitics are known to be able to “penetrate” into phrasal constituents as (ii) illustrates with *ba* appearing within a DP (see Kaufman 2010 for further discussion), so their attachment to the inverted pronoun (as opposed to a lower position) is perhaps expected. Unfortunately, genitive inversion in nominal constructions does not co-occur with a second DP-mate pronoun, so we cannot test the interaction of genitive inversion and pronominal clitics in this environment.

(i) INVERTED POSSESSOR PRONOUNS HOST CLITICS

- a. [Ang **akin pala=ng** anak] ang na-nalo sa paligsahan!  
 NOM 1SG.OBL MIR=LK offspring NOM PFV-win OBL contest  
 ‘Turns out it was my child who won the contest!’
- b. [Ang **akin ba=ng** tibay] ay tibay ng mga bato?  
 NOM 1SG.OBL Q=LK sturdiness TOP sturdiness GEN PL stone  
 ‘Is my strength the strength of stones?’

Job 6:12 (Ang Biblia 1978)

<https://www.biblegateway.com/passage/?search=Job+6:12&version=ABTAG1978>

- (ii) [Ang kapatid **ba** ni Maria] ang nagwa~walis?  
 NOM sibling Q GEN.P Maria NOM AV.IMPF~sweep  
 ‘Is the one who is sweeping Maria’s sibling?’





as sketched in (41).<sup>22</sup>

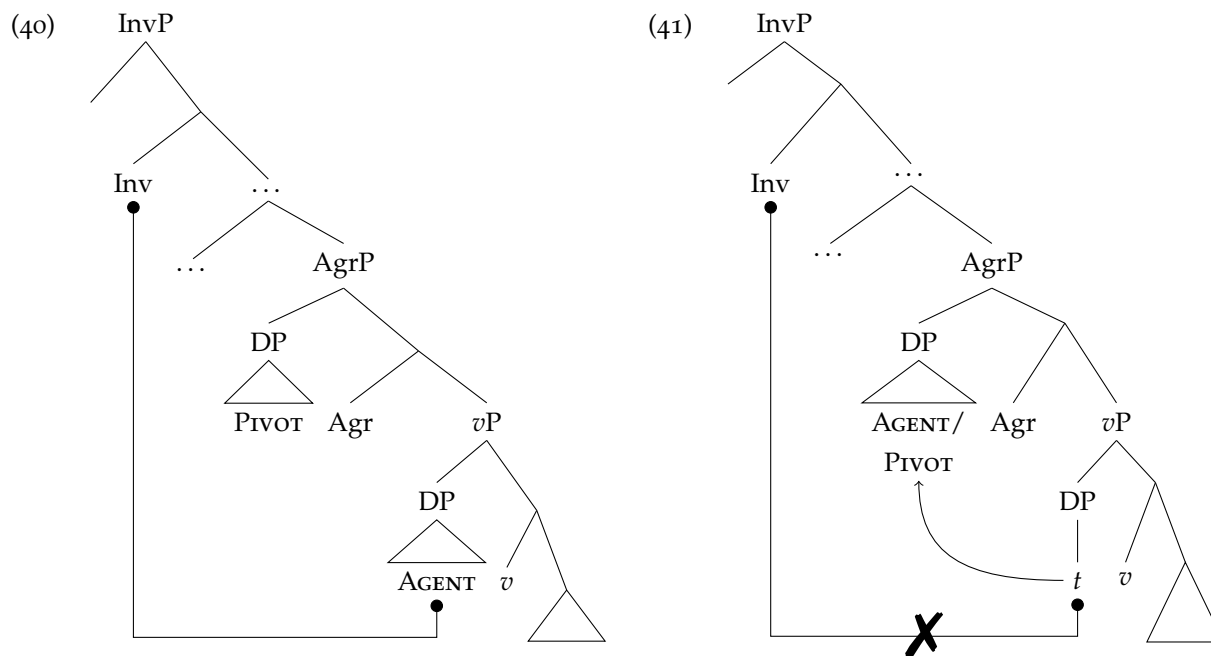

A second question relates to the form alternation exhibited by the inverted pronoun. For now, I simply assume that  $\text{Inv}^0$  assigns abstract oblique Case to its specifier, to address the theory-internal Case licensing needs of *pro* after movement (recall the extension to Béjar and Massam's (1999) MCC analysis proposed in Sec. 5.2.2). Importantly, this structural oblique Case should be distinguished from *sa*-marking elsewhere in the language, which we saw in Section 2.4.2 is prepositional.

That said, Culwell-Kanarek (2005) proposes an alternative view where the observed alternation is purely morphological (see also Kaufman 2010). He notes that the genitive pronouns are all second position clitics, while the series traditionally labeled oblique consists of free pronouns. Following this, he proposes that the so-called oblique pronouns are better analyzed as the free pronoun forms of the genitive clitic pronouns. In other words, the claim is that pairs like *ko~akin* should be characterized as different forms (clitic and free, respectively) of the first person singular genitive pronoun, rather than as different case forms (genitive and oblique). Some support for this claim comes from an independently attested instance of clitic-free alternation with the *nominative* second person singular pronoun *ka~ikaw*. I do not pursue a concrete implementation of this approach here, but one prominent detail that would need addressing is that under this view, prepositional *sa* would select a genitive-marked form when its complement is pronominal but a morphologically caseless DP/NP otherwise (recall from Sec. 2.4.2.2 that *sa* is never followed by *ng*, for instance).

Lastly, there is also the question of why the linker surfaces with genitive inversion. For this question, I have nothing of substance to speculate on, except to mention that further study of this construction may be informative for our general understanding of this particle, which has quite a wide distribution in

<sup>22</sup>Daniel Kaufman (p.c.) points out that the fact that nominative pronouns are excluded from genitive inversion can be straightforwardly understood under an alternative view of Tagalog clause structure where the nominative-marked pivot lies *outside* the predicate constituent containing the verb and all of its other dependents. Under such a configuration, the external argument would be the highest DP accessible to a potential high predicate-internal probe.

the language.

Despite these issues listed for future research, we have nevertheless seen that genitive inversion is a process targeting external arguments that moves them from their base position in the thematic domain to higher ones. In a sense, this process shows us that external arguments are not as “frozen in place” as we might otherwise suspect given the traditional formulation of the Tagalog pivot-only extraction restriction. In fact, I show in the next two sections that this alternative movement possibility has implications for the formation of DP-targeted  $A'$ -dependencies in this language. We will see how genitive inversion allows for the formation of genitive agent dependencies (representing a more straightforward application) and subextraction dependencies (which are slightly more complex).

### 6.3 Genitive agent dependencies

I refer to the first subclass of non-agreeing DP  $A'$ -dependencies under discussion as the genitive agent dependency subclass. These constructions are in some sense minimally different from the canonical voice-agreeing dependencies discussed in Section 5 because they involve typical verbally-predicated clauses where the dependency simply targets a non-pivot external argument. Following the discussion on genitive inversion, I propose that these constructions are possible because external argument *pro* may undergo this movement to escape the thematic domain and become sufficiently local to the clause-edge  $\lambda$ -operator.

An example of this dependency is provided in (42b), where the genitive-marked agent of the base-line sentence corresponds to the head of the relative clause. This example contrasts with the voice-agreeing dependencies in (43): (43a) shows a theme RC using the same PV verb form, while (43b) shows an AV form with the same agent dependency target.

(42) GENITIVE AGENT DEPENDENCY

- a. H<in>a~habol ng bata ang manok.  
 IMPF~chase[PV] GEN child NOM chicken

‘The child is chasing the chicken.’

Baseline PV Sentence

- b. <sup>?</sup>Nagta~tago ang bata=ng [h<in>a~habol ang manok (kanina)].  
 AV.IMPF~hide NOM child=LK IMPF~chase[PV] NOM chicken earlier

‘The child [who is/was chasing the chicken (earlier)] is hiding.’

Genitive Agent RC

- (43) a. Nagta~tago ang manok na [h<in>a~habol ng bata (kanina)].  
 AV.IMPF~hide NOM chicken LK IMPF~chase[PV] GEN child earlier

‘The chicken [that the child is/was chasing (earlier)] is hiding.’

Nominative Theme RC

- b. Nagta~tago ang **bata**=ng [nagha~habol ng manok (kanina)].  
 AV.IMPF~hide NOM child=LK AV.IMPF~chase GEN chicken earlier

‘The child [who is/was chasing the chicken (earlier)] is hiding.’

Nominative Agent RC

As these constructions represent exceptions to the widely accepted generalization about DP  $A'$ -dependencies in Tagalog, I first dedicate some discussion to the behavior exhibited by this construction.

In particular, notice that I have indicated that (42b) is judged by speakers as being marginally acceptable with a “?”. Given this marginal grammaticality, one may wonder to what extent it is valid to consider such examples “real” cases of *A'*-dependencies, as opposed to, say, some kind of occasional disfluency or production error. In what follows, I present evidence showing that despite their marginal grammaticality, genitive agent dependencies in fact behave quite consistently.

### 6.3.1 Background and distribution

In this section, I show that the behavior of genitive agent dependencies is in fact rather consistent in a number of ways. First, we will see that the intermediate grammaticality of these dependencies, specifically with relative clauses, goes beyond the realm of introspective grammaticality judgments in an elicitation setting. Second, we will also see that these dependencies can be formed over external arguments of various types of clauses. I argue that this behavior shows that there is something special about external arguments (in contrast with internal arguments) that allows the formation of these dependencies.

Let us first turn to issues relating to grammaticality. In the context of introspective grammaticality judgments in a typical elicitation setting, many speakers I have worked with tend to hesitate to reject or accept genitive agent dependencies like (42b) outright, offering comments such as “it’s understandable, but it doesn’t sound the most natural”. In contrast to such responses, the same speakers are quick to reject examples with genitive *theme* dependencies like the relative clause in (44b), provided for comparison. On other occasions, speakers may more readily judge the genitive agent dependency as ungrammatical, but when explicitly asked to compare to a similar genitive theme dependency (e.g., (42b) vs (44b)), they judge the agent dependency as more acceptable.

#### (44) UNGRAMMATICAL GENITIVE THEME DEPENDENCY

a. Nagha~habol ang bata ng manok.

AV.IMPF~chase NOM child GEN chicken

‘The child is chasing a chicken.’

Baseline

b. \*Nagta~tago ang manok na [nagha~habol ang bata (kanina)].

AV.IMPF~hide NOM chicken LK AV.IMPF~chase NOM child earlier

Intended: ‘The chicken [that the child is/was chasing (earlier)] is hiding.’

Genitive Theme RC (cf. 42b)

Within the literature on Tagalog (and other Philippine languages to some extent), genitive agent dependencies have recently received increasing amounts of attention (see, e.g., Tanaka et al. 2016; Pizarro-Guevara and Wagers 2018; Erlewine and Lim 2018; Erlewine 2018). Pizarro-Guevara and Wagers (2018) in particular have provided important initial experimental evidence for the robustness of the intermediate grammaticality of such dependencies. They investigated the range of logically possible *A'*-dependency targets in monotransitive clauses, crossing case marking on the target (NOM vs GEN) and thematic role (agent vs theme), and found that the acceptability of genitive agent dependencies like (42b) fell between that of pivot dependencies like (43) (regardless of theta-role), which were the most acceptable, and that of genitive *theme* dependencies like (44b), which were the least acceptable. These results mirror the judgments

from my elicitation work, which were presented above.

Also in line with the fact that these constructions are judged by speakers to not be totally ungrammatical, we find genitive agent dependencies attested in natural language use as well. For example, (45a), which is an excerpt from a tweet from a Filipino comedian, contains a relative clause headed by the nominal *single parent*. Given that there are two gaps in this relative clause, one for the agent of *binubuhay* ‘provides for’ and one for the possessor of *anak* ‘offspring’, one indication that we are dealing with an agent gap in this datapoint is the fact that an overt pronoun is grammatical as the possessor but not as the agent, as shown in (45b). As shown in (46), overt resumptive pronouns are generally ill-formed in Tagalog, so we can take the ungrammaticality of the agent pronoun in (45b) to indicate that the dependency gap corresponds to the agent.

- (45) a. Ang tawag sa **single parent** na [pa-túloy na b<in>u~búhay ang mga anak] ay  
 NOM call OBL single parent LK ADV-continue LK IMPF~life[PV] NOM PL offspring TOP  
 “responsáble=ng táo”.  
 responsible=LK person  
 ‘What we call a single parent who continually provides for their<sub>SG</sub> children is “responsible person”.’  
 Tweet<sup>23</sup>
- b. Ang tawag sa single parent na [pa-túloy na b<in>u~búhay (\*niya) ang mga anak  
 NOM call OBL single parent LK ADV-continue LK IMPF~life[PV] 3SG.GEN NOM PL offspring  
 (niya)] ay “responsáble=ng táo”.  
 3SG.GEN TOP responsible=LK person  
 ‘What we call a single parent who continually provides for their<sub>SG</sub> children is “responsible person”.’  
 With overt pronouns
- c. Pa-túloy na b<in>u~búhay ng **single parent** ang mga anak (niya).  
 ADV-continue LK IMPF~life[PV] GEN single parent NOM PL offspring 3SG.GEN  
 ‘The single parent continually provides for their<sub>SG</sub> children.’  
 Baseline

(46) UNGRAMMATICAL RESUMPTIVE PRONOUNS

- a. \*Nagta~tago ang bata=ng [h<in>a~habol niya ang manok (kanina)].  
 AV.IMPF~hide NOM child=LK IMPF~chase[PV] NOM chicken earlier  
 Intended: ‘The child [who he is/was chasing the chicken (earlier)] is hiding.’  
 Genitive resumptive (cf. 42b)
- b. \*Nagta~tago ang manok na [h<in>a~habol {siya /ito } ng bata (kanina)].  
 AV.IMPF~hide NOM chicken LK IMPF~chase[PV] 3SG.NOM PROX(NOM) GEN child earlier  
 Intended: ‘The chicken [that the child is/was chasing it (earlier)] is hiding.’  
 Nominative resumptive (cf. 43a)

<sup>23</sup>Ethel Booba (@IamEthylGabison), “Sa street kasi namin ang tawag sa single parent na patuloy na binubuhay ang mga anak ay “responsableng tao”. Charot,” Twitter, May 3, 2017, 2:45 p.m., <https://twitter.com/IamEthylGabison/status/859841263062761472>.

The robustness of genitive agent dependencies also generalizes to different structures. For example, long-distance genitive agent dependencies are possible. (47) shows us that the same contrast between targeting a genitive agent and a genitive theme is preserved when the target is in an embedded clause. The ungrammatical (48) also shows that the Matrix Verb Constraint (Sec. 5.4.1) is also active with this type of dependency.

## (47) LONG-DISTANCE GENITIVE AGENT DEPENDENCIES

- a. ?Nagta~tago ang bata=ng [na-panaginip-an ko=ng [h<in>a~habol ang duwende]].  
 AV.IMPF~hide NOM child=LK PFV.NVOL-dream-LV 1SG.GEN=LK IMPF~chase[PV] NOM dwarf

'The child [who I dreamt [was chasing the dwarf]] is hiding.'

Embedded genitive agent dependency

- b. \*Nagta~tago ang duwende=ng [na-panaginip-an ko=ng [nagha~habol ang bata]].  
 AV.IMPF~hide NOM dwarf=LK PFV.NVOL-dream-LV 1SG.GEN=LK AV.IMPF~chase NOM child

Intended: 'The dwarf [who I dreamt [the child was chasing]] is hiding.'

\*Embedded genitive theme dependency

## (48) MATRIX VERB CONSTRAINT IS ACTIVE WITH GENITIVE AGENT DEPENDENCIES

- \*Nagta~tago ang bata=ng [**n-anaginip** ako=ng [h<in>a~habol ang duwende]].  
 AV.IMPF~hide NOM child=LK PFV.NVOL-dream-LV 1SG.GEN=LK IMPF~chase[PV] NOM dwarf

Intended: 'The child [who I dreamt [was chasing the dwarf]] is hiding.'

(cf. 47a)

Furthermore, clause types of different valencies and different non-AV voice specifications. That is, this type of dependency is possible outside of monotransitive clauses or PV clauses. The examples below show this for monotransitive clauses that use a non-PV form for theme pivots (49), low applicatives (50), and causatives (51). The (a) examples show genitive agent dependencies, while the (b) examples (and (50c)) show genitive theme dependencies for comparison. We see the same pattern as before: while genitive agent dependencies may be marginal, genitive theme dependencies are totally ill-formed.

## (49) LV MONOTRANSITIVE CLAUSE

- a. ?Ma-busisi=ng mag-linis ang bata=ng [h<in>ugas-**an** ang paborito ko=ng plato].  
 ADJ-meticulous=LK AV-clean NOM child=LK <PFV>wash-LV NOM favorite 1SG.GEN=LK plate

'The child [who washed my favorite plate] cleans meticulously.'

?Genitive agent RC

- b. \*Gáling sa lola ko ang plato=ng [nag-hugas ang bata].  
 from OBL grandmother LK NOM plate=LK AV.PFV-wash NOM child

Intended: 'The plate [that the child washed] is from my grandmother.'

\*Genitive theme RC

## (50) LOW APPLICATIVE CLAUSE

- a. ?Kuripot ang kaibiga[n]=ng [b<in>ilh-**an** kami ng pasalubong].  
 stingy NOM friend=LK <PFV>buy-LV 1PL.EXCL.NOM GEN souvenir<sup>25</sup>

'The friend [who bought us souvenirs] is (normally) stingy.'

?Genitive agent RC

<sup>25</sup>A *pasalubong* is a gift given in the context of traveling, either after returning from a destination, or to people at the destination.

- b. \*Ma-sarap ang pasalubong na [b<in>ilh-an kami ng kaibigan namin].  
 ADJ-delicious NOM souvenir LK <PFV>buy-LV 1PL.EXCL.NOM GEN friend 1PL.EXCL.GEN  
 Intended: ‘The souvenir/gift [our friend bought us] was delicious.’ \*Genitive theme RC (LV)
- c. \*Ma-sarap ang pasalubong na [b<um>ili ang kaibigan namin para sa  
 ADJ-delicious NOM souvenir LK <AV>buy(PFV) NOM friend 1PL.EXCL.GEN for OBL  
amin].  
 1PL.EXCL.OBL  
 Intended: ‘The souvenir/gift [our friend bought for us] was delicious.’ \*Gen. theme RC (AV)

## (51) CAUSATIVE CLAUSE

- a. P<um>unta na sa mall ang laláki=ng [i-pa~pa-ayos ang kanya=ng sapatos].  
 <AV>go(PFV) NOW OBL mall NOM man=LK CV-FUT~CAUS-fix NOM 3SG.OBL=LK shoe  
 ‘The man [who is going to have his shoes repaired] has gone to the mall.’ Genitive causer RC
- b. \*Kulay itim daw ang sapatos na [mag-pa~pa-ayos si Ben].  
 color black QUOT NOM shoe LK AV-FUT~CAUS-fix NOM.P Ben  
 Intended: ‘The shoes [that Ben is going to have repaired] are reportedly black.’  
 \*Genitive theme RC

The patterns illustrated above are summarized schematically in (52), showing the base position of *pro*. These examples demonstrate not only that genitive agent dependencies are quite general, but also that their formation is sensitive to structural factors. That is, rather than being exceptional behavior exhibited by of monotransitive- and/or PV clauses, we see that these dependencies are possible because of the accessibility of the external argument, as (52a,c) show. Similarly, the *inaccessibility* of the genitive theme cannot be reduced to a quirk about AV clauses, as (50b) provides an ill-formed genitive theme relative clause with a non-AV verb, suggesting that, as summarized in (52b,d), the ungrammaticality we observe stems from a property intrinsic to genitive themes. Despite their reduced grammaticality compared to the canonical voice-agreeing DP dependencies discussed in Chapter 5, we thus see that genitive agent dependencies nevertheless show systematic behavior that should be accounted for. The next section addresses this need.

- (52) a. ✓[ PIVOT<sub>THM</sub> Agr<sup>0</sup> [<sub>vP</sub> pro<sub>GEN</sub> v<sup>0</sup> [<sub>VP</sub> V<sup>0</sup> t<sub>THM</sub>]]] cf. (49a), (51a)
- b. \*[ PIVOT<sub>AGT</sub> Agr<sup>0</sup> [<sub>vP</sub> t<sub>AGT</sub> v<sup>0</sup> [<sub>VP</sub> V<sup>0</sup> pro<sub>GEN</sub>]]] cf. (49b), (50c), (51b)
- c. ✓[ PIVOT<sub>GOAL</sub> Agr<sup>0</sup> [<sub>vP</sub> pro<sub>GEN</sub> v<sup>0</sup> [<sub>VP</sub> V<sup>0</sup> [<sub>AppIP</sub> t<sub>GOAL</sub> AppI<sup>0</sup> THM]]]]] cf. (50a)
- d. \*[ PIVOT<sub>GOAL</sub> Agr<sup>0</sup> [<sub>vP</sub> AGT v<sup>0</sup> [<sub>VP</sub> V<sup>0</sup> [<sub>AppIP</sub> t<sub>GOAL</sub> AppI<sup>0</sup> pro<sub>GEN</sub>]]]]] cf. (50b)

6.3.2 Derivation by *pro*

Here, I present an account of genitive agent dependencies, extending the analysis previously proposed in Chapter 5 for voice-agreeing dependencies. As mentioned at the beginning of this chapter, I propose

the formation of these dependencies also involves *pro*. The major difference these dependencies have with the voice-agreeing ones is that in these constructions, an argument other than *pro* has undergone pivot movement to Spec-AgrP. This means that pivot movement is no longer a possible strategy for satisfying the locality requirement on  $\lambda$ -operator binding posited in Chapter 5. Instead, I propose here that the process of genitive inversion (Sec. 6.2) provides an alternative to pivot movement for achieving locality with the operator. Since we have seen that genitive inversion only applies to (pronominal) external arguments, we account for the fact that genitive external arguments are possible targets for this dependency, but genitive internal arguments are not, as (52) above schematizes. Let us begin the discussion by reviewing the role of *pro* in deriving DP A'-dependencies.

Recall from the previous chapter that I proposed a non-A'-movement analysis for the more well-studied subset of DP A'-dependencies, where the dependency gap corresponds to the nominative-marked pivot of the clause, shown in (53b). This analysis relies on a null pronoun *pro* that is bound by an operator introduced at the clause edge. In Section 5.3, I claimed that the binding relationship between the operator and *pro* exhibited a locality requirement, so that in regular declarative clauses, a *pro* in the thematic domain would not be local enough to the clause-edge operator. Subsequently, one way of resolving the locality requirement was posited to be pivot movement, thus deriving the behavior conforming to the commonly noted pivot-only restriction in Tagalog. More specifically, resolving the locality requirement via pivot movement was proposed to derive the difference in grammaticality between examples like (53b) with an agent pivot relative clause and (53c) with a genitive theme relative clause.

- (53) a. Naki~kinig ang pinsan ko ng podcast.  
 AV.IMPF~listen NOM cousin 1SG.GEN GEN podcast  
 'My cousin listens to podcasts.' Baseline declarative
- b. Ma-talino ang pinsan ko=ng [naki~kinig pro ng podcast].  
 ADJ-smart NOM cousin 1SG.GEN=LK AV.IMPF~listen GEN podcast  
 'My cousin who listens to podcasts is smart.' Voice-agreeing RC
- c. \*Nakakaantok ang mga podcast na [naki~kinig ang pinsan ko].  
 sleep-inducing NOM PL podcast LK AV.IMPF~listen NOM cousin 1SG.GEN  
 Intended: 'The podcasts that my cousin listens to are sleep-inducing.' Genitive theme RC

I propose here that the same mechanism of a null pronoun *pro* and a clause-edge operator derives the observed cases of genitive dependencies, including those of genitive agents. That is, a shared core mechanism is responsible for generating *all* DP-targeted dependencies, whether the dependency target is a nominative pivot or otherwise. The primary motivation for such an approach lies in the fact that genitive dependencies take the same surface forms as other DP dependencies (i.e., linker relative clauses and pseudoclefts). This surface structure contrasts with those of non-DP A'-dependencies, which I argue in Chapter 7 are derived by conventional A'-movement. As the examples in (54-55) show, genitive agent dependencies cannot be formed using *kung*-RCs or focus fronting (see also Chapter 4).

## (54) GENITIVE AGENT RELATIVE CLAUSES

- a. ?Ma-talino ang pinsan ko=**ng** [pinaki~kingg-an ang mga podcast ng NPR].  
 ADJ-smart NOM cousin 1SG.GEN=LK pa.IMPF~listen-LV NOM PL podcast GEN NPR  
 ‘My cousin who listens to NPR’s podcasts is smart.’ Linker RC
- b. \*Ma-talino ang pinsan ko **kung** {sino /nino } [pinaki~kingg-an ang mga podcast  
 ADJ-smart NOM cousin 1SG.GEN if who.NOM who.GEN pa.IMPF~listen-LV NOM PL podcast  
 ng NPR].  
 GEN NPR  
 Intended: ‘My cousin who listens to NPR’s podcasts is smart.’ \*Kung-RC

## (55) GENITIVE AGENT FOCUS CONSTRUCTIONS

- a. ?Sino **ang** [pinaki~kingg-an ang mga podcast ng NPR]?  
 who NOM pa.IMPF~listen-LV NOM PL podcast GEN NPR  
 ‘Who listens to NPR’s podcasts?’ Pseudocleft
- b. \*{Sino /Nino } [pinaki~kingg-an ang mga podcast ng NPR]?  
 who.NOM who.GEN pa.IMPF~listen-LV NOM PL podcast GEN NPR  
 Intended: ‘Who listens to NPR’s podcasts?’ \*Focus Fronting

Having said this, a major question presents itself in the process of extending the account of DP A'-dependencies. To see this, let us walk through an example. Let us assume, as with other DP dependencies, that *pro* is generated in the relevant base position, in this case the external argument position. In a voice-agreeing dependency like (53b), the external argument *pro* bears the feature [PIVOT] and is thus targeted by  $\text{Agr}^0$  for movement to Spec-AgrP, as (56a) illustrates. As previously mentioned, this movement satisfies the proposed locality requirement between *pro* and the clause-edge operator as it moves *pro* out of the thematic domain (*v*P). On the other hand, in a genitive agent dependency like (54a), a different argument moves to Spec-AgrP leaving *pro* in the thematic domain. (56b) shows the resulting structure when the theme is the pivot argument.

(56) DERIVATIONAL POSSIBILITIES WITH AGENT *pro*

- a. AV CLAUSE (
- pro*
- PIVOT)

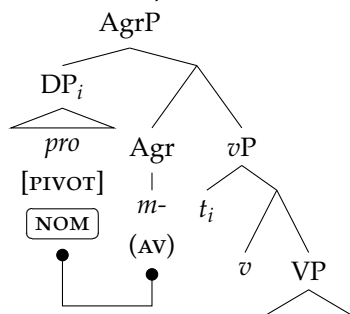

- b. NON-AV CLAUSE (OTHER PIVOT)
- <sup>26</sup>

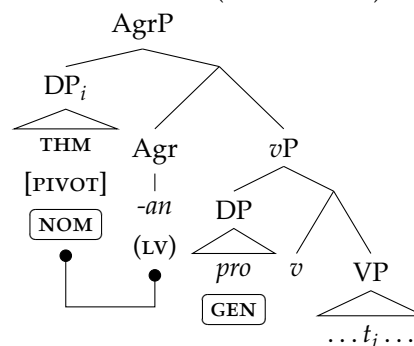

<sup>26</sup>In (56b),  $\text{Agr}^0$  is shown spelling out the LV morpheme *-an* to reflect the morphology on *pinakikinggan* ‘listens to (LV)’ in (54a).



If the derivation in (56b) were to continue with *pro* remaining in this position, then we would expect binding to be unsuccessful due to the posited locality requirement. This locality issue was the explanation proposed in Section 5.3 for the ill-formedness of genitive theme dependencies like (53c), so we should predict genitive *agent* dependencies to also be ill-formed. However, we have just seen in Section 6.3.1 that this prediction is not borne out. Thus, there must be some other mechanism by which the genitive agent is able to achieve locality to the clause-edge operator that is unavailable to the genitive theme. I propose that this other mechanism is genitive inversion.

Recall from Section 6.2 that genitive inversion targets pronominal genitive (i.e., non-pivot) external arguments, moving them to a position higher in their containing extended projection. In verbally predicted clauses for example, we saw that the inverted pronoun precedes negation, as (57) shows. In relative clause contexts, then, I propose that an external argument *pro* can undergo genitive inversion to become local to a clause-edge  $\lambda$ -operator. The result is shown in (58), which continues the derivation from (56b). I use *InvP* to indicate the projection involved in genitive inversion, and assume that abstract oblique Case is assigned in its specifier; see Section 6.2.5.

- (57) ...s<in>a~sabi ni Duterte sa kanya=ng mga talumpati [na **kanya=ng hindi** pa~payag-an  
 IMPF~say[PV] GEN.P Duterte OBL 3SG.OBL=LK PL speech LK 3SG.OBL=LK NEG FUT~allow-LV  
 ang pag-renew ng ABS-CBN]...  
 NOM pag-renew GEN ABS-CBN

‘...Duterte has been saying in his speeches that he would not allow the renewal of ABS-CBN...’  
 (repeated from 29b)

- (58) EXTERNAL ARGUMENT *pro* UNDERGOES GENITIVE INVERSION (continued from 56b)

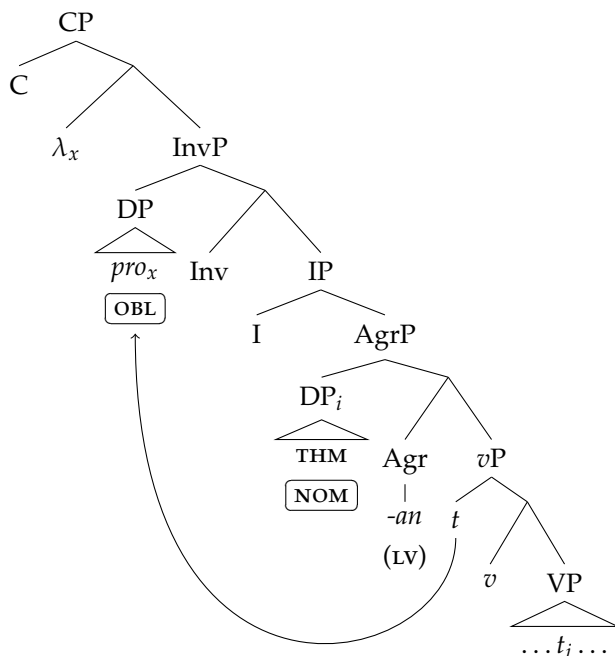

As mentioned in Sec. 3.1, the mapping between voice morphology and thematic role exhibits numerous sub-patterns that I do not discuss in detail in this thesis.

The result of this structure is a predicate of individuals that can function as a relative clause modifier. I assume, as with the voice-agreeing dependencies, that this modifier may combine with an NP to form a local dependency (following Sec. 5.3), or become the complement of a clause-embedding verb to create a long-distance dependency (following Sec. 5.4).

We have now seen two strategies in Tagalog for satisfying the locality requirement in binding between *pro* and a  $\lambda$ -operator, which was first posited in Section 5.3. The first of these strategies is pivot movement to Spec-AgrP, discussed in Chapter 5, while the second is genitive inversion, discussed here. Both strategies are independently available to agents, leading to distinct outcomes. If an agent *pro* undergoes pivot movement, the result is a voice-agreeing linker relative clause with AV morphology on the verb. On the other hand, if the agent *pro* undergoes genitive inversion (i.e., because a different argument has undergone pivot movement), then the result is a genitive agent dependency with non-AV morphology on the verb. In contrast, we have seen that, empirically speaking, internal arguments cannot undergo genitive inversion, so I posit that pivot movement is the only strategy possible in typical declarative clauses for this kind of argument to become sufficiently local to the  $\lambda$ -operator for binding.<sup>27</sup> The result is that themes and other internal arguments may only participate in voice-agreeing dependencies.<sup>28</sup>

From the picture of Tagalog DP relative clauses we have so far, two questions can be raised. The first relates to the difference just highlighted between the behavior of internal and external arguments. Under an alternative analysis, this difference could be readily captured by adopting the common assumption that  $v^0$  is a phase head, and thus its complement (containing the internal arguments) is not accessible to probing while its specifier (i.e., the external argument) is. Given this, we might ask if positing movement of the external argument *pro* via genitive inversion is even necessary. Put differently, given the alternative approach appealing to the phasehood of  $vP$ , could we not instead say that *pro* can be bound by the operator in its base Spec- $vP$  position? Part of the issue is the lack of formal concreteness in this thesis regarding the locality of binding. However, I propose in the next subsection (Sec. 6.4) that the behavior of subextraction dependencies suggests that the answer to this first question is “no”. Specifically, we will see that dependencies cannot be formed if *pro* is “trapped” in Spec- $vP$ , as would be the case if it corresponds to the possessor *within* a non-pivot agent DP.

The second question relates to movement. We have so far seen that the locality requirement between *pro* and the operator can be satisfied by a few movement processes. We might therefore ask: is movement necessary, or is it also possible in some instances for *pro* to be bound in its base position? As I argue in Section 6.5, the behavior of free dependencies provide evidence that movement is in fact *not* necessary, strictly speaking. In that subsection, it will be argued that reduced clausal structure allows binding of *pro*, even if it appears in-situ.

<sup>27</sup>Note also that we do not expect this movement to be available to (non-pronominal) full DPs, as we have seen that they cannot undergo genitive inversion.

<sup>28</sup>So far in this chapter, I have discussed how the external argument is privileged over internal arguments (particularly themes) and how this privileged status drives a number of effects that we see with non-agreeing DP dependencies. An alternative approach that is worth pursuing, but which I will not be able to in this thesis, would be to take this contrast between external and internal arguments and flip it on its head. That is, under an approach that builds DP A'-dependencies in Tagalog using a null pronoun (*pro*) that introduces a semantic variable to be bound later in the derivation, to what extent are the different patterns that we find explained not by some intrinsic property of *pro* (i.e., the proposed nominative licensing requirement), but instead by the incompatibility of certain positions (e.g., (non-pivot) themes) with pronouns.

## 6.4 Subextraction

The second subclass of voice-disagreeing dependencies will be referred to as the subextraction class.<sup>29</sup> As the name suggests, these are *A'*-dependencies where the gap corresponds not to a dependent of the main predicate of the relative clause, but instead to a sub-dependent of such a dependent. Concretely, I discuss possessor subextraction, which has been noted at least as early as Schachter and Otnes (1972). In (59), we see that the head of the relative clause, *doktor* ‘doctor’ is construed as the possessor of the pivot of the relative clause. A second example is provided in (60). Note that the possessor in the baseline examples cannot be marked nominative, as (59a) and (60a) show, making it clear that subextraction dependencies indeed target genitive positions.

(59) SUBEXTRACTION DEPENDENCY (Ceña 1979)

a. Pa-lagi=ng umi~iyak [ang anak {ng /\*ang} doktor].  
 ADV-always=LK AV.IMPF~cry NOM offspring GEN NOM doctor  
 ‘The child of the doctor is always crying.’ Baseline (ex.10, modified)

b. Na-dismaya ang doktor na [pa-lagi=ng umi~iyak [ang anak \_\_\_]].  
 PFV-disappoint NOM doctor LK ADV-always=LK AV.IMPF~cry NOM offspring  
 ‘The doctor whose child is always crying was disappointed.’  
 Possessor Subextraction RC (ex.12)

(60) a. Bago [ang lapis {ng /\*ang} bata].  
 new NOM pencil GEN NOM child  
 ‘The child’s pencil is new.’ Baseline

b. bata=ng [bago ang lapis \_\_\_]  
 child=LK new NOM pencil  
 ‘child with the new pencil’ Possessor Subextraction RC (Schachter and Otnes 1972, p.135)

This section discusses the behavior and distribution of subextraction dependencies, and provides an analysis for their derivation following the previous proposal for genitive agent dependencies. Like genitive agent dependencies, subextraction dependencies exhibit some degree of marginal grammaticality, with seemingly more variability in the judgements. Also like genitive agent dependencies, I propose that the distribution of subextraction dependencies reflects the posited locality requirement on the binding of *pro*. In this case, we will see that *both* movement operations discussed previously, pivot movement and genitive inversion, are required to form the dependency, due to the fact that *pro* appears within a DP.

### 6.4.1 Background

Subextraction dependencies are similar to genitive agent dependencies in a few ways. First, they use the same type of construction. We have seen, for example, that subextraction dependencies use the linker

<sup>29</sup>This process has also been referred to as *possessor ascension*. For example Kroeger (1993, pp.32-3) borrows the term from Bell’s (1983) Relational Grammar analysis of a similar phenomenon in Cebuano.

strategy for relativization. Similarly, pseudoclefts are used for *wh*-questions, shown in (61), and focus constructions.

## (61) SUBEXTRACTION WITH PSEUDOCLEFTS

- a. Sino ang pa-lagi=ng umi~iyak [ang anak \_\_\_ ]?  
 who NOM ADV-always=LK AV.IMPF~cry NOM offspring  
 ‘Whose child is always crying?’
- b. Sino ang bago [ang lapis \_\_\_ ]?  
 who NOM new NOM pencil  
 ‘Whose pencil is new?’

As shown in (62), *kung*-RCs and focus fronting cannot be used. Notably, we cannot attribute the ungrammaticality of these examples simply to the lack of an appropriate (i.e., non-DP) *wh*-expression. We see in (62) that the examples are ungrammatical not only with *sino* but also with *kanino* ‘who.OBL’, which, in addition to questioning oblique-marked proper nouns, is used elsewhere in the language for questions regarding possessors. For example, (63) shows that *kanino* can be used in the clause-initial predicate position, either within a larger nominal expression as in (63a), or as a predicate on its own as in (63b). Note that in these examples, the possessum is the subject/pivot of the clause.

## (62) SUBEXTRACTION CANNOT TAKE THE FORM OF A NON-DP DEPENDENCY

- a. \*{Kanino /Sino} pa-lagi=ng umi~iyak [ang anak \_\_\_ ]?  
 who.OBL who.NOM ADV-always=LK AV.IMPF~cry NOM offspring  
 Intended: ‘Whose child is always crying?’
- b. \*Na-dismaya ang doktor kung {kanino /sino} pa-lagi=ng umi~iyak [ang anak \_\_\_ ].  
 PFV-disappoint NOM doctor if who.OBL who.NOM ADV-always=LK AV.IMPF~cry NOM offspring  
 Intended: ‘The doctor whose child is always crying was disappointed.’

(63) *Kanino* IN POSSESSOR QUESTIONS

- a. {**Kanino**=ng anak /Anak **nino**}<sup>31</sup> ang pa-lagi=ng umi~iyak?  
 who.OBL=LK offspring offspring who.GEN NOM ADV-always=LK AV.IMPF~cry  
 ‘Whose child is always crying?’ / ‘The one always crying is whose child?’
- b. **Kanino** ang bago=ng lapis?  
 who.OBL NOM new=LK pencil  
 ‘Whose is the new pencil?’ / ‘The new pencil is whose?’

<sup>31</sup>Note that the alternation between *kaninong* and *nino* shown here could be considered an instance of genitive inversion (see Sec. 6.2). Interestingly, genitive inversion of *wh*-expressions is only possible in nominal constructions, and not in verbal ones as (63) shows.

(63) {\*Kanino=ng k<in>uha /K<in>uha nino } ang mga itlog?  
 who.OBL=LK <PFV>take[PV] <PFV>take[PV] who.GEN NOM PL egg  
 ‘Who took the eggs?’ (as an echo question)

Second, subextraction dependencies also show a restriction on dependency formation similar to what we saw with genitive agent dependencies, whereby external arguments are accessible. That is, the dependency gap may only correspond to the possessor of a nominal phrase, and not a complement, even though complements are also marked genitive. The examples in (65) show ungrammatical attempts to relativize the complements of *sako* ‘sack’ and *kahon* ‘box’; compare these with the possessor-targeted relatives in (66) and the baseline sentences in (67). Note that as with genitive agent dependencies, subextraction dependencies can exhibit some degree of marginality in their acceptability, which potentially improves depending on the context. This marginality nevertheless contrasts with the clearly ungrammatical cases.

## (65) NOUN COMPLEMENTS CANNOT BE RELATIVIZED

- a. \*Gáling sa Batangas ang bigas na [pula ang sako \_\_\_ ng magsasaká].  
 from OBL Batangas NOM rice LK red NOM sack GEN farmer  
 Intended: ‘The rice, the farmer’s sack of which is red, is from Batangas.’
- b. \*Luma na ang mga damit na [i-ni-labas ni Helen ang kahon \_\_\_ ni Fred].  
 old now NOM PL clothes LK CV-PFV-out GEN.P Helen NOM box GEN.P Fred  
 Intended: ‘The clothes, Fred’s box of which Helen took out, are old.’

## (66) POSSESSORS CAN BE RELATIVIZED

- a. Gáling sa Batangas ang magsasaká=ng [pula ang sako ng bigas \_\_\_].  
 from OBL Batangas NOM farmer=LK red NOM sack GEN rice  
 ‘The farmer [whose sack of rice is red] is from Batangas.’
- b. ?Ma-tangkad ang laláki na [i-ni-labas ni Helen ang kahon ng damit \_\_\_].  
 ADJ-tall NOM man LK CV-PFV-out GEN.P Helen NOM box GEN clothing  
 ‘The man [whose box of clothes Helen took out] is tall.’

## (67) NOUN WITH DEPENDENTS IN-SITU

- a. Pula ang sako **ng bigas** ng magsasaká.  
 red NOM sack GEN rice GEN farmer  
 ‘The farmer’s sack of rice is red.’
- b. I-ni-labas ni Helen ang kahon **ng damit** ni Fred.  
 CV-PFV-out GEN.P Helen NOM box GEN clothes GEN.P Fred  
 ‘Helen took out Fred’s box of clothes.’

Subextraction exhibits additional properties not found with genitive agent dependencies, however. Most clearly, these dependencies exhibit an interaction with Case. Previous work has established that the DP from which subextraction occurs must be the nominative-marked pivot of the clause (Branan 2018; Kroeger 1993; Nakamura 1996; see also Schachter and Otones 1972, pp.135–6 on examples with adjectival predicates). The examples in (68) show that the relative clause head *laláki* ‘man’ can only be construed as the possessor of the theme *aso* ‘dog’ if the theme is the pivot, as in (68a).<sup>32</sup>

<sup>32</sup>Subextraction has also been noted to be sensitive to alienability of possession and the affectedness of the DP subextracted from,

(68) SUBEXTRACTION GAP MUST BE IN PIVOT (adapted from Kroeger 1993, p.33)

a. Alalá=ng alalá ang laláki=ng [k<in>agat ng ahas [ang aso \_\_\_]].  
 worried=LK worried NOM man=LK <PFV>bite[PV] GEN snake NOM dog

‘The man [who a snake bit the (i.e., his) dog] is very worried.’

b. \*Alalá=ng alalá ang laláki=ng [k<um>agat ang ahas [ng aso \_\_\_]].  
 worried=LK worried NOM man=LK <AV>bite(PFV) NOM snake GEN dog

Intended: ‘The man [who a snake bit the (i.e., his) dog] is very worried.’

Let us now turn to the analysis of these dependencies, starting with a more detailed discussion of the two distributional properties of the dependency gap that we have just seen: that it must be a possessor, and that it must be contained within the pivot of a clause. These properties will point us in the direction of an account.

### 6.4.2 Two distributional properties of subextraction dependencies

As with the other linker RCs considered thus far (voice-agreeing in Chapter 5 and genitive agent dependencies in Section 6.3), I propose that while *pro* plays a crucial role in the derivation of subextraction dependencies, it is generated in a position that is insufficiently local to the clause-edge operator. In this instance, *pro* appears *within* a DP that is itself generated in the thematic domain of a clause. The question is therefore how this locality problem is resolved in this type of construction. This turns out to be fairly straightforward given previous discussion. Two restrictions exhibited by subextraction dependencies, listed in (69), inform the analysis.

(69) In a subextraction dependency, *pro* must

- a. be the highest argument in a DP and
- b. be contained in the pivot DP of the immediately containing clause

These properties find parallels in the behavior of genitive agent dependencies and (long-distance) voice-agreeing dependencies, respectively. Thus, the analysis of subextraction dependencies combines the proposals for both to derive the attested behavior for this dependency subtype. In this section, I discuss these properties, and compare them to the parallel behaviors found in the other environments.

---

such that dependencies are more acceptable when the possessor is inalienable and the possessum is more affected (Kroeger 1993, pp.32–3). A potential contrast due to affectedness can be seen with the minimal pair below. These examples differ in how affected the possessed theme (i.e., *ang anak* ‘the offspring’) is by the verb; compare *binagsak* ‘flunked (pv)’ in (i) with *nakita* ‘saw (pv)’ in (ii).

(i) K<in>ausap ko ang nanay na [b<in>agsak ni Juan [ang anak \_\_\_]].  
 <PFV>Speak.with[PV] 1SG.GEN NOM mother LK <PFV>fail[PV] GEN.P Juan NOM offspring  
 ‘I spoke with the mother whose child Juan flunked.’

Affected theme

(ii) \*<sup>2</sup>K<in>ausap ko ang nanay na [na-kita ni Juan [ang anak \_\_\_]].  
 <PFV>Speak.with[PV] 1SG.GEN NOM mother LK NVOL.PFV-see[PV] GEN.P Juan NOM offspring  
 ‘I spoke with the mother whose child Juan saw.’

Un-/Less affected theme

However, such effects appear to not be so clear cut. Examples like (60) exist, where it is hard to see how affected *lapis* ‘pencil’ is by the predicate *bago* ‘new’ or how inalienable its possession relation is with *bata* ‘child’. More detailed work on these particular behaviors should be undertaken. For the purposes of this thesis, I will assume that the effects of affectedness and alienability are secondary.

The restriction to possessors in subextraction dependencies is parallel to what we have seen with genitive agent dependencies, as exemplified in (70) and (71), respectively. Both restrictions privilege external arguments over other types of arguments, one being operative in the nominal domain while the other in the verbal domain. This parallelism suggests that the derivation of subextraction dependencies involves the same mechanism proposed for genitive agent dependencies. That is, *pro* must move out of its base position in the thematic domain to be sufficiently local to the operator at the edge of the clause. However, *pro* is only able to undergo such movement if it is an external argument, as diagnosed by genitive inversion in nominals (Section 6.2).

## (70) EXTERNAL ARGUMENT RESTRICTION FOR SUBEXTRACTION DEPENDENCIES

- a. <Um>alis na ang babae=ng [ma-laki [ang sako ng bigas]].  
 <AV>leave(PFV) already NOM woman=LK ADJ-big NOM sack GEN rice  
 ‘The woman [whose sack of rice is big] has left.’ Possessor gap
- b. \*Gáling sa Benguet ang bigas na [ma-laki [ang sako ng babae]].  
 from OBL Benguet NOM rice LK ADJ-big NOM sack GEN woman  
 Intended: ‘The rice, [the woman’s sack of which is big], is from Benguet.’ \*Noun comp. gap

## (71) EXTERNAL ARGUMENT RESTRICTION FOR GENITIVE AGENT DEPENDENCIES

- a. Hu~hulih-in ko ang pusa=ng [h<in>a~habol ang aso].  
 FUT~catch-PV 1SG.GEN NOM cat=LK IMPF~chase[PV] NOM dog  
 ‘I will catch the cat [that is chasing the dog].’ Agent gap
- b. \*Hu~hulih-in ko ang aso=ng [h<um>a~habol ang pusa].  
 FUT~catch-PV 1SG.GEN NOM dog=LK AV.IMPF~chase NOM cat  
 ‘I will catch the dog [that the cat is chasing].’ \*Theme gap

Given this parallel, I propose that genitive inversion is also involved in subextraction dependencies. However, genitive inversion in the nominal domain does not move a pronoun out of its containing DP, as (72) illustrates. This limitation of genitive inversion in nominal contexts thus leads us to the second restriction of subextraction dependencies.

## (72) GENITIVE INVERSION WITH NOMINAL CONSTRUCTIONS IS DP-BOUND

(cf. 70a)

- a. Ma-laki [DP ang kanya=ng sako ng bigas].  
 ADJ-big NOM 3SG.OBL=LK sack GEN rice  
 ‘Her sack of rice is big.’
- b. \*{Kanya=ng} ma-laki {kanya=ng} [DP ang sako ng bigas].  
 3SG.OBL=LK ADJ-big NOM sack GEN rice  
 Intended: ‘Her sack of rice is big.’

The requirement that the DP containing *pro* be the pivot of a clause can be straightforwardly tied to the parallel behavior found in the voice-agreeing dependencies of Chapter 5. In particular, we find strong

similarities with long-distance dependencies (Sec. 5.4), which cross multiple *clause* boundaries rather than DP boundaries. Recall from Section 5.4 that these kinds of dependencies exhibited a property that I referred to as the Matrix Verb Constraint (MVC), which requires that intervening (clause-embedding) verbs between the operator and the minimal clause containing the gap appear in specific voice forms. For example, the minimal pair in (73) shows long-distance dependencies out of a clause embedded under the verb *banggit* ‘mention’. The embedded verb *bibili* ‘will buy’ appears in AV as expected, as we have an agent gap, but we also see that the *embedding* verb must appear in the PV form *binanggit*, and not the AV form *nagbanggit*.

## (73) VOICE RESTRICTIONS WITH LONG-DISTANCE A'-DEPENDENCIES

- a. D<um>ating na ang bata=ng [**b<in>anggit** ng manininda na [bi~bili \_\_\_\_  
 <AV>arrive(PFV) already NOM child=LK <PFV>mention[PV] GEN vendor LK FUT~buy[AV]  
 ng kamias]].  
 GEN kamias

‘The child [who the vendor mentioned [would buy *kamias*]] has arrived.’

- b. \*D<um>ating na ang bata=ng [**nag-banggit** ang manininda na [bi~bili \_\_\_\_ ng  
 <AV>arrive(PFV) already NOM child=LK AV.PFV-mention NOM vendor LK FUT~buy[AV] GEN  
 kamias]].  
 kamias

Intended: ‘The child [who the vendor mentioned [would buy *kamias*]] has arrived.’

As previously discussed, the MVC in these trans-clausal long-distance dependencies can be understood as a requirement that the embedded clause containing *pro* must be the (effective) pivot of the matrix clause. This is the case in (73a) but not in (73b). Note in particular that the matrix clause of the relative clause modifier (predicated by *binanggit/nagbanggit*) bears a nominative-marked DP (*ang manininda* ‘the vendor’) in the latter but not the former. In this regard, the pivothood requirement in subextraction dependencies can be considered a nominal counterpart of the MVC. This is the same generalization that we have seen for subextraction dependencies, shown in (74) and previously in (68).<sup>33</sup> The parallelism is presented schematically in (75), where the effective pivot argument of the matrix clause is boxed.

## (74) VOICE RESTRICTIONS WITH POSSESSOR SUBEXTRACTION

- a. Natu~tulog na ang bata=ng [**naglu~luto** ng lechon [ang tatay \_\_\_\_]].  
 AV.IMPF~sleep already NOM child=LK AV.IMPF~COOK GEN lechon NOM father

‘The child [whose father is cooking *lechon*] is already sleeping.’

- b. \*Natu~tulog na ang bata=ng [**nilu~luto** [ng tatay \_\_\_\_] ang lechon].  
 AV.IMPF~sleep already NOM child=LK IMPF~COOK[PV] GEN father NOM lechon

Intended: ‘The child [whose father is cooking *lechon*] is already sleeping.’

<sup>33</sup>Branan (2018) also discusses this parallelism between subextraction and long-distance dependencies in Tagalog, and proposes an analysis of subextraction dependencies by extending Rackowski and Richards’s (2005) proposal for long-distance dependencies in Tagalog. I discuss his proposal in the context of my proposal later on in Section 6.4.5.



(75) SUBEXTRACTION DOMAIN (CP OR DP) MUST BE THE PIVOT (BOXED)<sup>34</sup>

- a.  $\checkmark$  HEAD LK  $\lambda_i$  [ V ... DP<sub>GEN</sub> ... [ DP/CP ... *pro*<sub>i</sub> ... ] ]
- b. \*HEAD LK  $\lambda_i$  [ V ... DP<sub>NOM</sub> ... [ DP/CP ... *pro*<sub>i</sub> ... ] ]

In Section 5.4, it was proposed that the MVC was tied to the locality requirement on the binding of *pro*. Specifically, I claimed that pivot movement of *pro* in (only) the embedded clause did not put it in a position local enough to the operator at the matrix clause edge. Thus, I proposed a mechanism for introducing an instance of *pro* in the matrix clause to itself undergo pivot movement and be bound by the operator in question. Here, I propose that a similar situation holds for subextraction dependencies: movement of *pro* in the embedded clause (i.e., genitive inversion) is not itself enough to satisfy locality, thus requiring pivot movement in the matrix clause as well. We will also see that due to the difference in the embedded environment (CP vs DP) the details of what happens in the matrix clause differ between trans-clausal long-distance dependencies and subextraction dependencies.

Subextraction dependencies thus represent a context where we find attested both types of movement previously proposed to be involved in the formation of linker RCs. The remainder of this section is dedicated to spelling out this proposal more concretely and considering its advantages over previously proposed accounts. I begin by discussing some background on the internal structure of nominals.

### 6.4.3 Background on nominal structure

Like clauses, nominal phrases in Tagalog have a structure that is strongly head-initial. As we have seen, the head nominal precedes both possessors as well as complements, as (76) illustrates. On the other hand, functional material, particularly the plural marker *mga* and the various nominal markers precede the head nominal.

- (76) a. ang mga **sako** [ng bigas] [ni Juan]  
 NOM PL sack GEN rice GEN.P Juan  
 ‘[Juan’s] sacks [of rice].’
- b. ang **balita**=ng [nang-anak na ang asawa ko]  
 NOM news=LK AV.PFV-offspring already NOM spouse 1SG.GEN  
 ‘the news that [my spouse has given birth]’

Among the dependents of a nominal phrase, there is a preference for the complements to precede possessors. Thus, (76a) is grammatical, while (77) is highly marked, if not totally ungrammatical. This behavior interestingly contrasts with what we find in verbal constructions, where external arguments either tend to surface adjacent to the verb as in (78) (see Bondoc and Schafer 2019 for experimental verification), or have freer word order as in (79). I take this word order preference as evidence that N<sup>0</sup> and its complement form a constituent on the surface (i.e., NP).

<sup>34</sup>Note that I do not indicate a voice specification for V in these schematics. The specific voice form used is only significant insofar as it determines which dependent serves as the pivot of the clause. That is, no voice form is ungrammatical for subextraction/long-distance dependencies across all verbs. For example, (73) shows an ungrammatical example with the AV form *nagbanggit* ‘mentioned (AV)’, but (74) has the AV form *nagluluto* ‘is cooking (AV)’ as the grammatical example of the pair.

(77)\*?ang mga **sako** [ni Juan] [ng bigas]

NOM PL sack GEN.P Juan GEN rice

Intended: '[Juan's] sacks [of rice].'

(78) AGENT-FIRST PREFERENCE IN VERBAL CLAUSES

a. Bi~bigy-an ka [ng guro] [ng kendi].

FUT~give-LV 2SG.NOM GEN teacher GEN candy

'The teacher will give you candy.'

b.??Bi~bigy-an ka [ng kendi] [ng guro].

FUT~give-LV 2SG.NOM GEN candy GEN teacher

Intended: 'The teacher will give you candy.'

(79) WORD ORDER FLEXIBILITY IN GERUNDS

a. ang pag-inom [ng pasyente] [ng gamot]

NOM pag-drink GEN patient GEN medicine

'the patient's taking of medicine.'

b. ang pag-inom [ng gamot] [ng pasyente]

NOM pag-drink GEN medicine GEN patient

'the patient's taking of medicine.'

Further evidence for the constituent status of NP can be found with adjectival placement. Adjectives in Tagalog may appear in multiple positions in a nominal phrase. In cases where only a head noun is modified, it is typically possible for the adjective to either precede or follow the noun, as in (80). However, (81) shows that the immediately post-nominal position in (81b) is not available if a complement is present. Other positions are, in contrast, possible although (81a) with the adjective appearing pre-nominally is the least marked.

(80) FLEXIBLE ADJECTIVE ORDER

a. ang **ma-laki**=ng sako

NOM ADJ-big=LK sack

'the big sack'

b. ang sako=ng **ma-laki**

NOM sack=LK ADJ-big

'the big sack'

(81) ADJECTIVE PLACEMENT IN COMPLEX NOMINALS

a. ang mga **ma-la-laki**=ng sako ng bigas ni Juan.

NOM PL ADJ-PL~big=LK sack GEN rice GEN.P Juan

- b. \*ang mga sako=ng **ma-la~laki** ng bigas ni Juan.  
 NOM PL sack=LK ADJ-PL~big GEN rice GEN.P Juan
- c. ?ang mga sako ng bigas na **ma-la~laki** ni Juan.  
 NOM PL sack GEN rice LK ADJ-PL~big GEN.P Juan
- d. ?ang mga sako ng bigas ni Juan na **ma-la~laki**.  
 NOM PL sack GEN rice GEN.P Juan LK ADJ-PL~big  
 ‘Juan’s big sacks of rice’

To derive the head-initial word order as well as the close association between the noun and its complement, I adopt the structure in (82). Here, the NP constituent moves past the possessor generated in Spec-*nP* to a position between NumP and *nP*, in a projection I label XP. I assume the existence of XP mainly for concreteness and do not propose a specific account regarding its nature, as it ultimately does not affect the analysis of *A'*-dependencies developed here. For example, we might alternatively assume that the attested word order reflects a right-side specifier for *nP*, with NP staying in-situ.<sup>35</sup> I further assume that *mga* spells out Num<sup>0</sup>, and, following Sec. 2.4, that *ang*, *ng*, and their allomorphs spell out D<sup>0</sup>.

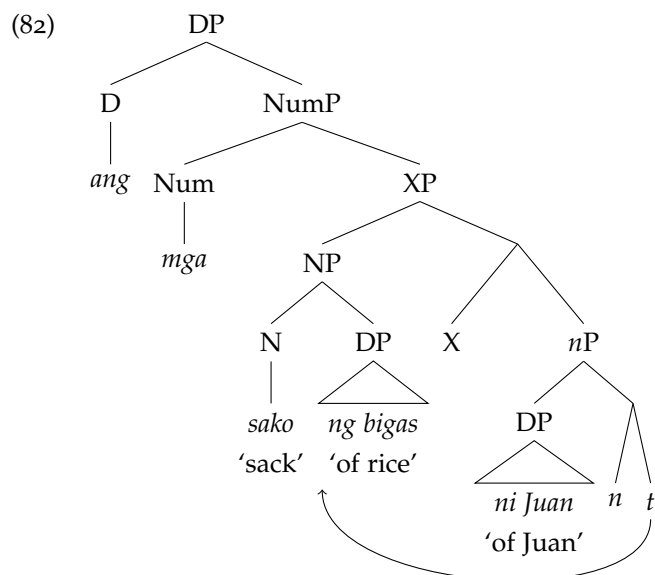

Recall from Section 6.2.4 that genitive inversion in the nominal domain precedes both adjectives and the plural marker, as (83a) shows. I thus assume that InvP is also found in nominal structures, appearing between DP and NumP as in (83b).

- (83) a. ang aki[n]=ng {<sup>?</sup>ma-ta~taba-ng} mga {ma-ta~taba=ng} pusa  
 NOM 1SG.OBL=LK ADJ-PL~fat=LK PL ADJ-PL~fat=LK cat  
 ‘my fat cats’

<sup>35</sup>Yet another alternative that avoids positing the intermediate XP projection might be to posit that N<sup>0</sup> undergoes head movement to Num<sup>0</sup>. We can accommodate such an analysis by positing that the plural marker *mga* appears in Spec-NumP. However, this alternative does not straightforwardly capture the surface position of nominal complements.

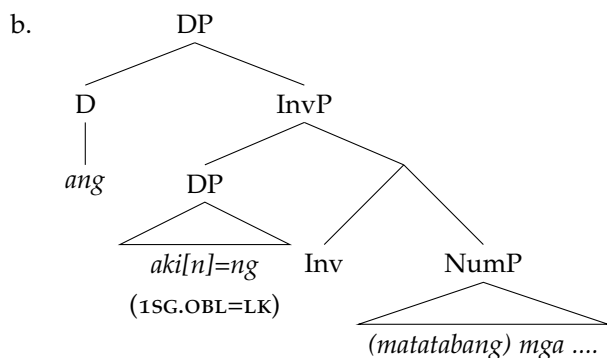

Having established this background, let us turn to the account of subextraction dependencies.

#### 6.4.4 Derivation by *pro*

I now lay out my proposal for the derivation of subextraction dependencies. For concreteness, I walk through the derivation for (84).

- (84) P<um>unta sa tindahan ang magsasaká=ng [na-butás [ang mga sako ng bigas \_\_\_]].  
 <AV>go(PFV) OBL store NOM farmer=LK PFV-hole NOM PL sack GEN rice  
 'The farmer [whose sacks of rice got punctured] went to the store.'

First, as with other dependencies involving this null pronoun, I assume that *pro* is base-generated in the relevant thematic position. Thus, in (85), *pro* appears in Spec-*nP*, taking the possessor role. As discussed in Section 6.4.3, I assume that NP moves to the specifier of a higher projection to generate the attested word order facts.

- (85) BASE GENERATION OF *pro* IN SPEC-*nP*

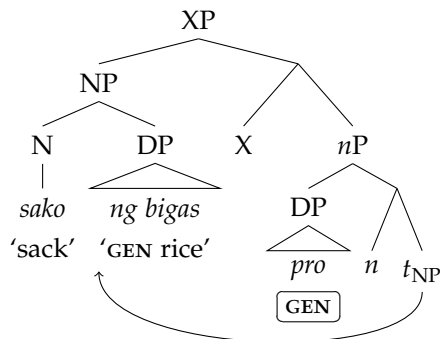

I propose that the locality requirement on binding also has implications for *pro* that appear within larger DPs, such that they must also escape their thematic domain, in this case *nP*. Thus, I propose that *pro* can undergo genitive inversion for this purpose, parallel to what was proposed for genitive agent dependencies in Section 6.3. Furthermore, genitive inversion is the only DP-internal strategy available, as pivot movement within the DP is impossible. Thus, *pro* can be bound by the clause-edge operator only if it can undergo genitive inversion (i.e., only if it is an external argument).<sup>36</sup> (86) shows the resulting DP structure.

<sup>36</sup>Similar speculation to that in fn.28 regarding an alternative account is applicable here. That is, we might speculate that

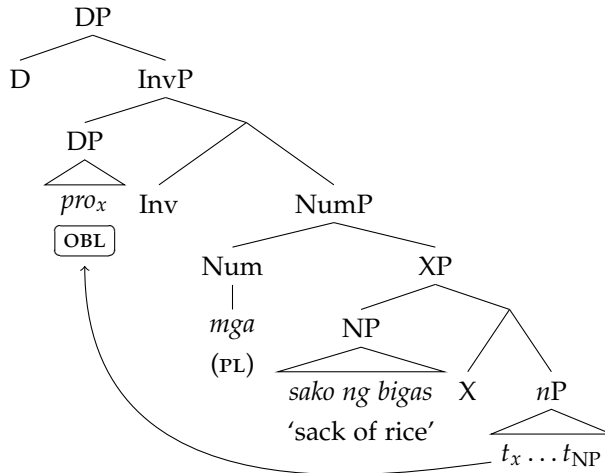
(86) DP STRUCTURE WITH GENITIVE INVERSION OF *pro*

Let us now consider what happens in the matrix clause. When the DP containing *pro* is introduced into the structure, it appears in a thematic position, as (87) shows. As with the previously considered constructions, I assume that the position of this DP internal to the thematic domain renders *pro* (this time contained within the DP) insufficiently local to the clause-edge operator, despite *pro* itself being in a higher position within the DP. Therefore, this DP must escape *v*P.

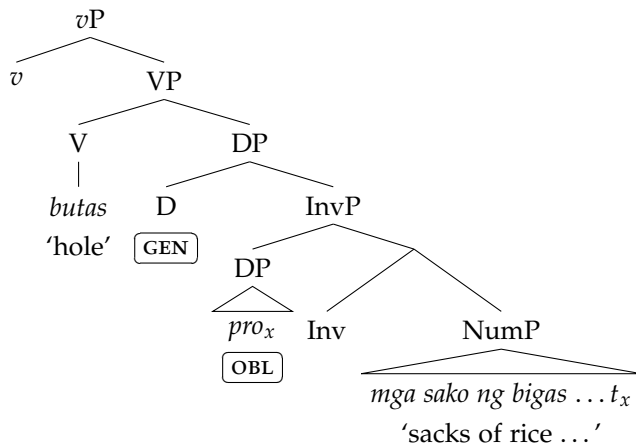
(87) BASE POSITION OF DP HOSTING *pro*

As in other clausal contexts, escape is possible through pivot movement to Spec-AgrP, as (88) shows. This is different from what we saw with trans-clausal long-distance dependencies in Section 5.4, where *pro* was contained within a CP. There, I proposed a mechanism of successive-cyclic binding that introduced an intermediate instance of *pro* to indirectly satisfy the posited locality requirement of binding. In this case, I assume that the DP-hood of the constituent containing *pro* allows for more straightforward movement to Spec-AgrP.

---

the asymmetry between possessors and noun complements may be primarily because pronouns are generally ill-formed as noun complements (i.e., the position of *ng bigas* 'GEN rice' in the example here). Exploration of this possibility is left to future work, partially because the internal structure of nominal constructions in Tagalog is less well-understood than that of verbal constructions, and partially because the implications of this alternative on the rest of the analysis presented in this thesis are potentially non-trivial.

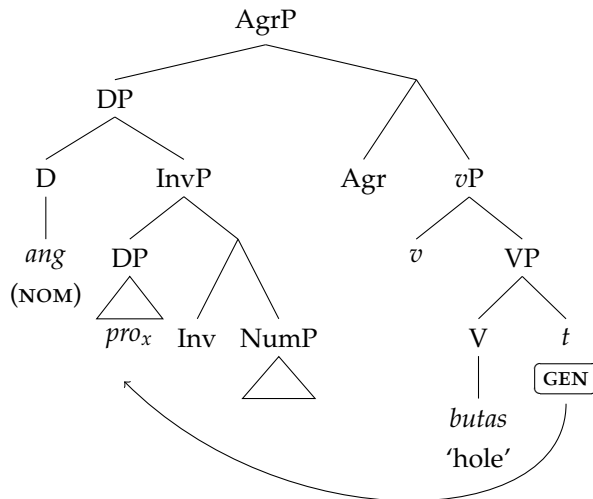
(88) PIVOT MOVEMENT OF DP HOSTING *pro*

From this point, the remainder of the derivation proceeds as has been previously proposed for other DP-targeted A'-dependencies in this language. That is, higher projections are introduced until the CP level, where a  $\lambda$ -operator is introduced. This operator binds the semantic variable introduced by *pro*, resulting in the expected predicate of individuals (type  $\langle e, t \rangle$ ), as the abbreviated semantic derivation in (90) shows.

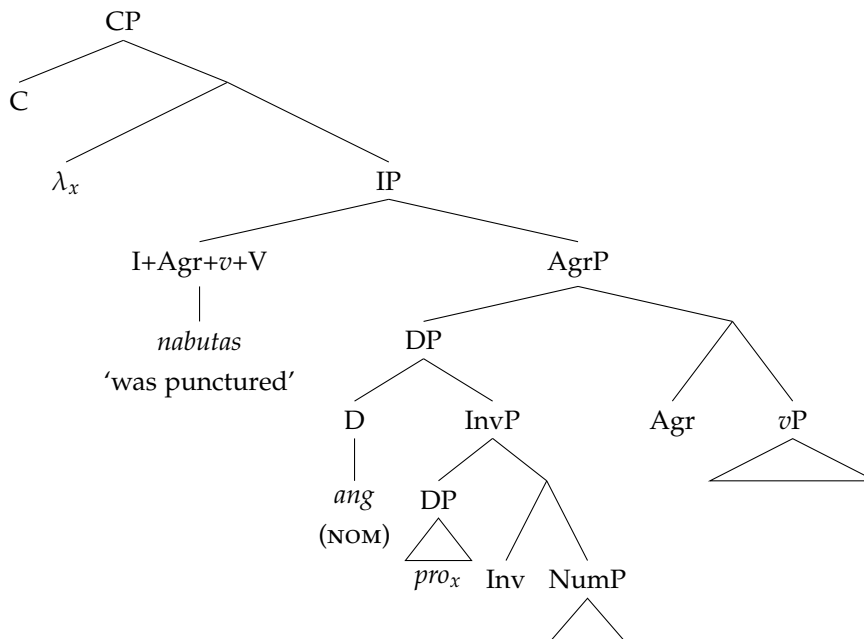
(89) INTRODUCTION OF  $\lambda$ -OPERATOR

## (90) ABBREVIATED SEMANTIC DERIVATION (SUBEXTRACTION DEPENDENCY)

a.  $\llbracket vP \rrbracket = \lambda e [\text{puncture}(y)(e)]$

b.  $\llbracket DP \rrbracket = \iota z [\text{sack}(z) \wedge \text{possr}(z)(x) \wedge \text{contains}(z)(\text{rice}) \wedge |z| > 1]$ <sup>37</sup>

<sup>37</sup>Here, I make simplistic assumptions about the semantics of plurality ( $|z| > 1$ ) and of the interpretation of the noun complement ( $\text{contains}(x)(\text{rice})$ ) for the sake of exposition.

- c.  $\llbracket \text{AgrP} \rrbracket = (\lambda y \llbracket \llbracket vP \rrbracket \rrbracket)(\llbracket \text{DP} \rrbracket)$   
 $= \lambda e [\text{puncture}(\iota z [\text{sack}(z) \wedge \text{possr}(z)(x) \wedge \text{contains}(z)(\text{rice}) \wedge |z| > 1])(e)]$
- d.  $\llbracket \text{CP} \rrbracket = \lambda x [\exists e [\text{puncture}(\iota z [\text{sack}(z) \wedge \text{possr}(z)(x) \wedge \dots])(e) \wedge \tau(e) < \text{now}]]$

We thus derive the correct denotation of the relative clause modifier, which is a predicate that holds of an individual  $x$  if there is a past event of a puncturing of sacks of rice possessed by  $x$ . This modifier may then proceed to compose with other components in the derivation, such as a relative clause head.

The analysis of subextraction dependencies just presented posited that two operations were necessary to establish locality between *pro* and the  $\lambda$ -operator at the clause edge. First, we saw that *pro* moves out of the thematic domain within its containing DP via genitive inversion. In this environment, genitive inversion is the only process available out of the two that we have seen for feeding the posited locality requirement on binding. This then restricts the valid dependency targets within a DP to possessors, as they are the only ones that can undergo genitive inversion.

Second, we saw that the DP containing *pro* undergoes pivot movement out of *its* own thematic domain in the matrix clause, thus deriving that valid dependency targets are contained in a nominative-marked pivot. Unlike in DP-internal environments however, we have seen that a second escape option—genitive inversion—is generally available in the verbal domain, and is involved in deriving genitive agent dependencies (Sec. 6.3). For subextraction dependencies, such an option is straightforwardly unavailable because the target of movement in the matrix clause is not a pronoun, but rather the full DP that *contains* the pronoun. As we have seen (Sec. 6.2), genitive inversion cannot target full DPs. The main consequence is then that valid dependency targets are restricted to only those that are contained within pivots.

This restriction to pivot movement in the matrix clause also has indirect implications for the analysis of genitive agent dependencies. Recall that at the end of Section 6.3, I discussed the possibility of the locality requirement on binding being the result of  $v^0$  being a phase head. That is, under the view that *Spec-vP* lies outside the phase boundary introduced by  $v^0$ , could the locality of binding be satisfied with the external argument *pro* in-situ rather than having to undergo genitive inversion as proposed? I argue that the behavior we find with subextraction dependencies suggests an answer in the negative. To see this, let us consider what happens when the dependency gap corresponds to the possessor of an external argument.

As (91) shows, relativizing the possessor of the agent is only grammatical if the agent is the pivot of the clause. Following the analysis proposed here, the trees in (92-93) sketch the structures of these two examples up to *AgrP*. We thus see that grammaticality correlates to the position of the agent DP, which contains *pro*. When this DP is in *Spec-AgrP*, the result is grammatical, but when it is in *Spec-vP*, the result is ill-formed. We also know that when the agent DP is a non-pivot, it must surface in *Spec-vP* and no higher, as genitive inversion is unavailable, in contrast to what we saw with genitive agent dependencies. Given that *pro* is accessible for binding when it (or its containing DP) is in *Spec-AgrP*, but not when it is unambiguously in *Spec-vP*, we must conclude that *pro* in a genitive agent dependency must also evacuate the *Spec-vP* position rather than remain in-situ for the dependency to be well-formed.

(91) VOICE RESTRICTIONS WITH POSSESSOR SUBEXTRACTION

repeated from (74)

- a. Natu~tulog na ang bata=ng [naglu~luto ng lechon [ang tatay \_\_\_]].  
 AV.IMPF~sleep already NOM child=LK AV.IMPF~COOK GEN *lechon* NOM father  
 'The child [whose father is cooking *lechon*] is already sleeping.'
- b. \*Natu~tulog na ang bata=ng [nilu~luto [ng tatay \_\_\_] ang lechon].  
 AV.IMPF~sleep already NOM child=LK IMPF~COOK[PV] GEN father NOM *lechon*  
 Intended: 'The child [whose father is cooking *lechon*] is already sleeping.'

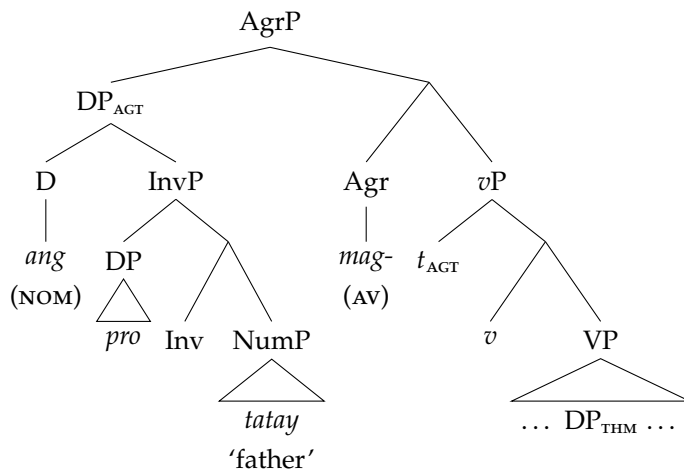
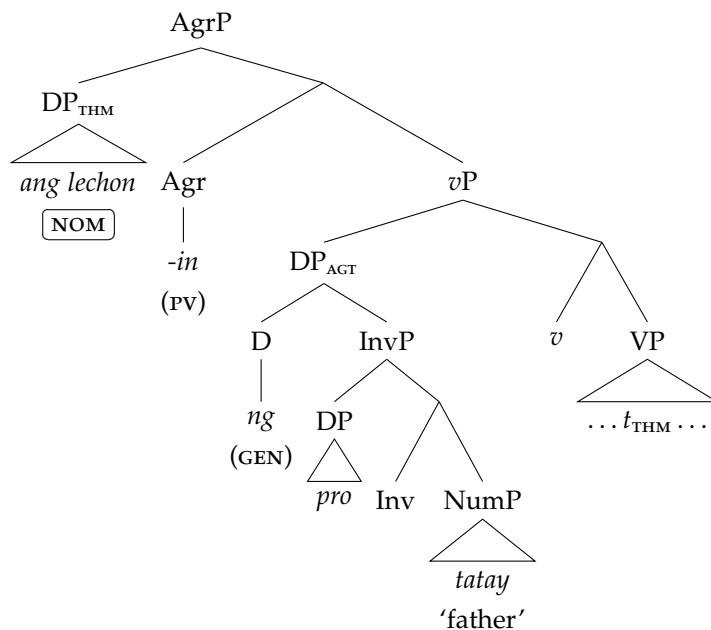
(92) NULL *pro* WITHIN PIVOT AGENT (cf. 91a)(93) NULL *pro* WITHIN NON-PIVOT AGENT (cf. 91b)

Having presented the analysis for subextraction dependencies and discussed some of its implications, I now consider it in the context of previous proposals that have been put forth for the same



phenomenon.

### 6.4.5 Advantages over previous analyses

The analysis of subextraction dependencies proposed here relies on *pro* and the posited locality requirement on its binding to derive the behavior observed with this construction. This results in a highly restricted system that determines what kinds of DPs can host *pro*, as well as what the status of *pro* is *within* its host DP. To my knowledge, this second property of subextraction dependencies has been under-described in the previous work on this construction. Instead, these existing analyses focus on capturing the pivot-only host restriction. Here, I discuss some of these existing analyses and show that they do not readily capture the restriction to external arguments accounted for by the *pro*-based analysis put forward in this thesis.

Two broad types of analysis will be considered: those based on economy, and those based on a mechanism of unlocking phases. I first discuss in turn how these approaches derive the pivot-only restriction on the DP host. Following this, I argue that these approaches fail to capture the aforementioned external argument restriction.

#### 6.4.5.1 Economy-based analyses

Economy-based analyses of *A'*-dependencies in Tagalog argue that many of the patterns exhibited by these constructions should be derived as the result of constraints on derivational economy. For concreteness, let us consider the analysis proposed by Nakamura (1996). He proposes that Tagalog optimizes its *A'*-movement operations for length, with a derivation being preferred if it involves shorter individual movement operations than alternative derivations within a specific set. This economy requirement is proposed to be active generally within the language, thus manifesting in a number of areas. For example, Nakamura shows that economy derives the basic extraction restriction facts in Tagalog, exemplified by the minimal pair in (94).

(94) BASIC EXTRACTION RESTRICTION CONTRAST

- a. \*sabaw na [CP  $\boxed{Op_i}$  [IP <si Johnkim> b<um>ili si Johnkim  $\boxed{t_i}$  ]]  
 soup LK <AV>buy(PFV) NOM.P Johnkim

Intended: 'soup that Johnkim bought'

\*AV Theme RC

- b. sabaw na [CP  $\boxed{Op_i}$  [IP  $\boxed{t_i}$  b<in>ili ni Johnkim  $t_i$  ]]  
 soup LK <PFV>buy[PV] GEN.P Johnkim

'soup that Johnkim bought'

PV Theme RC

Nakamura assumes that relative clauses in Tagalog are formed by movement of an operator from a base position to a clause-peripheral position. Thus, the examples in (94) represent two logically possible derivations for a theme relative clause. Both cases have *Op* base-generated in theme position (i.e., at the rightmost trace), and differ in the path taken to the clause periphery. In (94a), *Op* moves directly

from its base position to the clause periphery. In (94b) on the other hand, *Op* first undergoes an initial movement step to the pivot position (which Nakamura assumes to be Spec-IP) before proceeding to the same clause-peripheral landing site.

Nakamura (1996) argues that the two derivations in (94) are formal alternatives of each other. Specifically, he (pp.80–4) proposes a formulation of the Minimal Link Condition such that evaluation for economy in (94) is narrowed down to just the *wh*-chains (i.e., between the two boxed positions). Since the PV theme RC in (94b) involves a shorter *wh*-chain than the AV theme RC in (94a), it is more economical and thus wins out over the latter derivation, resulting in the observed difference in grammaticality.<sup>38</sup>

For subextraction dependencies, the reasoning is fairly similar. Nakamura assumes that *Op* may be generated as a possessor and moves out of its host DP to the edge of CP. Given this, two alternative derivations are possible for, say, relative clauses of possessors of themes, as (95) shows. In the AV clause in (95a), the theme stays in-situ, and *Op* moves from its base position to the CP edge. On the other hand, the PV clause in (95b) shows the theme moving (covertly at LF, as Nakamura proposes) to Spec-IP, shortening the distance between the base position of *Op* and its clause-peripheral landing site.<sup>39</sup> Thus, the PV derivation is more economical than the AV derivation, deriving the pivot-only DP host restriction.

- (95) a. \*bata=ng [CP  $\boxed{Op_i}$ ] [IP <ako> h<um>iram ako [ng lapis  $\boxed{t_i}$ ]]]  
 child=LK <AV>borrow(PFV) 1SG.NOM GEN pencil  
 Intended: ‘child whose pencil I borrowed’ \*AV Theme Possessor RC
- b. bata=ng [CP  $\boxed{Op_i}$ ] [IP <ang lapis  $\boxed{t_i}$ > h<in>iram ko [ang lapis  $t_{THM}$ ]]]  
 child=LK <PFV>borrow[PV] 1SG.GEN NOM pencil  
 ‘child whose pencil I borrowed’ PV Theme Possessor RC

#### 6.4.5.2 Unlocking-based analyses

A second type of proposal for deriving subextraction dependencies in Tagalog relies on a formalized notion of “unlocking” phases. This type of approach is proposed by Branan (2018), who extends the proposal by Rackowski and Richards (2005) for long-distance extraction out of embedded clauses in Tagalog. In linking possessor subextraction to multi-clausal long-distance extraction, Branan’s proposal operates on a similar intuition as the proposal put forth here in this section. I first recap the original analysis by Rackowski and Richards before discussing Branan’s extension to it.

As previously discussed in this thesis (see, primarily, Section 5.6), Rackowski and Richards (2005) propose an analysis of long-distance extraction out of embedded CPs that accounts for the restriction on the voice forms of the higher (clause-embedding) verbs along the path of the dependency. This restriction

<sup>38</sup>For him, the movement of *Op* within IP in (94b) is irrelevant for comparisons of economy as there is no chain link in the alternative derivation (94a) that is *comparable*, a term that he provides a formal definition of in the context of these economy comparisons.

<sup>39</sup>The covert movement of the pivot in these derivations appears to be due to particular assumptions Nakamura (1996, pp.85–7) adopts about absolutive (i.e., *ang*) Case checking occurring after Spell-Out in Tagalog. He thus uses the pivot restriction on possessor subextraction to argue that LF movement can move entire categories, instead of just features as Chomsky (1995) proposes. More specifically, because possessor subextraction—which is treated as a *wh*-movement phenomenon subject to economy considerations—is sensitive to the absolutive Case status—determined at LF—of the extraction domain, Nakamura argues that economy (i.e., the length of the *wh*-chain as relevant to the Minimal Link Condition) is evaluated at LF and that movement at LF in these examples must be of the full extraction domain rather than only of features.

was discussed in detail in Section 5.4, and reviewed in Section 6.4.2, from which the minimal pair example is repeated in (96).

(96) VOICE RESTRICTIONS WITH LONG-DISTANCE A'-DEPENDENCIES

- a. D<um>ating na ang bata=ng [**b<in>anggit** ng manininda na [bi~bili \_\_\_\_  
 <AV>arrive(PFV) already NOM child=LK <PFV>mention[PV] GEN vendor LK FUT~buy[AV]  
 ng kamias]].  
 GEN *kamias*
- 'The child [who the vendor mentioned [would buy *kamias*]] has arrived.'
- b. \*D<um>ating na ang bata=ng [**nag-banggit** ang manininda na [bi~bili \_\_\_\_ ng  
 <AV>arrive(PFV) already NOM child=LK AV.PFV-mention NOM vendor LK FUT~buy[AV] GEN  
 kamias]].  
*kamias*

Intended: 'The child [who the vendor mentioned [would buy *kamias*]] has arrived.'

The crux of Rackowski and Richards's proposal is that extraction out of the embedded CP first requires it to be "unlocked" because it is a phase. They formalize this concept of unlocking as an independent Agree operation initiated by a distinct probe on the same head that bears the A'-movement probe. Concretely, they claim that  $v^0$  in Tagalog has two probes: one for (intermediate) A'-movement, and one responsible for probing for and agreeing with the pivot argument of the clause. For purposes of exposition, let us call the second probe the voice-agreement probe. For the A'-probe to be able to access material internal to the CP phase, the voice-agreement probe must first Agree with this CP. The crucial reflex of this voice-agreement is the spell-out of voice morphology on the associated clause-embedding verb, which can be seen in (96a) as PV morphology on the verb *binanggit* 'mentioned'.

Extending Rackowski and Richards's (2005) proposal, Branan (2018) provides an analysis of the cross-linguistic patterns of possible possessor subextraction behavior. Here, I focus on the claims and predictions he makes for Tagalog, specifically. The modification Branan proposes is straightforward: in addition to unlocking CPs, voice agreement can also unlock DP phases. This straightforwardly derives the pivot-only restriction on the DP host with the same mechanism that is active with long-distance clausal dependencies. That is, subextraction may only occur out of the pivot because it is precisely the pivot that has been unlocked by voice-agreement.

### 6.4.5.3 A shared problem

The common problem shared by these two types of approaches is one of overgeneration. While we have seen that both approaches successfully derive the pivot-only host restriction, we will see here that they do not readily derive the restriction to only external arguments previously discussed.

Both types of approaches can be thought of as positing an extra step that must occur in the derivation in addition to what is otherwise typical A'-movement. For economy, this step is movement to Spec-IP, while for unlocking, this step is voice-agreement. If these steps have been fulfilled, then A'-movement out of the unlocked DP is predicted to show parallel behavior to A'-movement in the basic case. However, this

is the wrong prediction, not only for the inaccessibility of internal arguments (i.e., noun complements) as we have seen previously, but especially for the behavior of non-DP extraction. In fact, this problem is parallel to the one discussed in Section 5.6.2 for successive-cyclic movement accounts of long-distance dependencies out of embedded clauses.

The examples in (97) show that oblique dependents of nominals cannot be targeted for extraction (specifically focus), even if associated with a nominative-marked pivot (enclosed in square brackets). Corresponding baseline examples with the oblique in-situ are provided in (98).

(97) UNGRAMMATICAL SUBEXTRACTION OF NON-DPs FROM PIVOTS

- a. \*Saan(=[n]g subject) k<in>ausap ng kapatid ko [ang guro niya \_\_\_] sa mall?  
 what.OBL=LK subject <PFV>Speak.with[PV] GEN sibling 1SG.GEN NOM teacher 3SG.GEN OBL mall  
 Intended: ‘What (subject) is such that my sibling speaks to [his teacher of {it/that subject}] at the mall?’
- b. \*Sa ICU ga~gawa [ang mga nars \_\_\_] ng mga holiday card para sa mga pasyente.  
 OBL ICU FUT~make[AV] NOM PL nurse GEN PL holiday card for OBL PL patient  
 Intended: ‘It’s the ICU that is the unit such that the nurses in that unit will make holiday cards for the patients.’  
 OK as: ‘It’s in the ICU that the nurses (from any unit) will make holiday cards for the patients.’

(98) BASELINE SENTENCES

- a. K<in>ausap ng kapatid ko [ang guro niya **sa Filipino**] sa mall.  
 <PFV>Speak.with[PV] GEN sibling 1SG.GEN NOM teacher 3SG.GEN OBL Filipino OBL mall  
 ‘My sibling spoke with his {Filipino teacher/teacher of Filipino} at the mall.’
- b. Ga~gawa [ang mga nars **sa ICU**] ng mga holiday card para sa mga pasyente.  
 FUT~make[AV] NOM PL nurse OBL ICU GEN PL holiday card for OBL PL patient  
 ‘The nurses at the ICU will make holiday cards for the patients.’

Significantly, these obliques can be shown to be otherwise accessible to A'-dependency formation when their nominal phrase host is a clausal predicate (i.e., they are in a non-subextraction configuration). This kind of focus fronting can be rather marked out of the blue, but is quite natural given the right context, as with the examples in (99). In these examples, the clauses under discussion are enclosed in square brackets. We see that within these clauses, the relevant oblique phrases appear clause-initially. We also see that clausemate clitic pronouns immediately follow the fronted obliques, consistent with other instances of focus fronting. For comparison, (100) provides corresponding examples where the oblique phrases are in-situ.<sup>40</sup>

<sup>40</sup>There is a possibility that the fronting in examples like (99-100) can be explained by the relevant PPs not originating from within the nominal expression. This turns out to be difficult to resolve definitively with more straightforward examples. For instance, we cannot check the behavior of genitive-marked noun complements, because we independently expect them to *not* be able to undergo focus fronting. Evidence of a more indirect nature against the aforementioned possibility can be found in examples with *aging* ‘become’ that differ minimally from (99-100). We see with (i) that the focus fronted PP *sa Filipino* can only be interpreted as modifying the event of becoming, which naturally corresponds to a position outside the nominal *guro* ‘teacher’. In contrast, the fronted PP cannot be interpreted as a specification of the kind of teacher. Nevertheless, (ii) shows that the specification interpretation is not in

## (99) FOCUS FRONTING FROM A NOMINAL PREDICATE

- a. Guro nga namin si Vanessa, pero [sa Filipino namin siya guro],  
 teacher EMPH 1PL.EXCL.GEN NOM.P Vanessa but OBL Filipino 1PL.EXCL.GEN 3SG.NOM teacher  
 hindi sa biology.  
 NEG OBL biology  
 ‘Vanessa is indeed our teacher, but it’s in Filipino that she is our teacher, not in biology.’
- b. Nars nga ang kapatid ko, pero [sa ICU siya nars], hindi sa clinic.  
 nurse EMPH NOM sibling 1SG.GEN but OBL ICU 3SG.NOM nurse NEG OBL clinic  
 ‘It’s at the ICU that my sibling is a nurse, not at a clinic.’

## (100) NOMINAL PREDICATES WITH IN-SITU OBLIQUE DEPENDENTS

- a. [Guro namin sa Filipino] si Vanessa, hindi sa biology.  
 teacher 1PL.EXCL.GEN OBL Filipino NOM.P Vanessa NEG OBL biology  
 ‘Vanessa is our teacher in Filipino, not in biology.’
- b. [Nars sa ICU] ang kapatid ko, hindi sa clinic.  
 nurse OBL ICU NOM sibling 1SG.GEN NEG OBL clinic  
 ‘My sibling is a nurse in the ICU, not in a clinic.’

The difference in grammaticality between (99), showing focus fronting out of nominal predicates, and (97), showing focus fronting subextraction out of pivots, is problematic for the previous approaches to subextraction dependencies under discussion. As previously mentioned, we expect that subextraction should behave similarly to the basic cases once the mechanism accounting for the pivot-only restriction has taken effect. That is, for Nakamura’s (1996) economy approach, extraction from a DP that has moved to Spec-IP should behave like extraction out of a simple clause. On the other hand, for Branau’s (2018) unlocking approach, probing into an unlocked DP should show the same behavior as probing for a clausemate goal. The data and problems discussed here thus mirror those I discussed in Section 5.6.2 for long-distance dependencies originating within embedded CPs. For both dependencies out of CP and out of DP, existing analyses overgenerate with respect to the range of valid dependency targets.

In contrast, the approach I put forth here derives the limited behavior of Tagalog subextraction straightforwardly. Parallel to what I assumed for long-distance dependencies out of CPs, I assume that DPs (e.g., nominal expressions that bear overt determiners) are phases, and therefore that nothing may move out of them. Consequently, material within a DP that forms A’-dependencies through A’-movement

---

principle unavailable with *maging*. One way we can explain the interpretative differences between (i-ii) would be to say that *maging* blocks focus fronting of XPs that are internal to its nominal complement.

- (i)#[Sa Filipino naging guro] si Vanessa, hindi sa biology.  
 OBL Filipino PFV.become teacher NOM.P Vanessa NEG OBL biology  
 ‘It’s Filipino that Vanessa became a teacher of, not biology.’  
 Acceptable as: ‘It’s in Filipino (class) that Vanessa became a teacher, not in biology (class).’
- (ii) [Naging guro sa Filipino] si Vanessa.  
 PFV.become teacher OBL Filipino NOM.P Vanessa  
 ‘Vanessa became a teacher in Filipino.’

(i.e., non-DPs) will be unable to escape the DP phase, deriving the impossibility of non-DP-targeted dependencies out of DPs. On the other hand, material that relies on the *pro*-binding mechanism to form A'-dependencies (i.e., DPs) should still be targetable for such dependencies despite the DP phase edge. Crucially, this binding is not totally free, but for reasons unrelated to the DP phase edge. The locality requirement on binding *pro*, which plays a key role in deriving the behavior of other DP A'-dependencies such as the pivot-only restriction, also derives the very limited distribution of subextraction dependencies that we have seen here. That is, this locality requirement derives not only the restriction that only pivots may host *pro*, but also the restriction to external arguments, the latter resulting from an interaction with the internal mobility of different kinds of constituents within the DP.

We have thus seen two types of DP A'-dependencies where, as in voice-agreeing DP dependencies, *pro* must undergo movement through an independently available operation in order to be sufficiently local to an operator at the clause edge. In this chapter, we have seen that in addition to pivot movement (discussed in Chap. 5), *pro* may also undergo genitive inversion to satisfy locality. In genitive agent dependencies (Sec. 6.3), we saw that if a different clausemate argument of *pro* was targeted for movement to Spec-AgrP, *pro* could still escape the thematic domain via genitive inversion. On the other hand, with subextraction dependencies in the section above, we saw cases where both genitive inversion and pivot movement were necessary. Within a DP, only genitive inversion was possible, accounting for the restriction of this type of dependency to possessors. Within the matrix clause on the other hand, the DP hosting *pro* could only undergo pivot movement, as we saw that genitive inversion was only possible with pronouns. Thus, we see a range of possibilities that result from different combinations of movement operations and structures. These possibilities are summarized in Table 6.3.

Table 6.3: Summary of possible DP dependencies based on the types of movement

| <i>pro</i> undergoes... | Matrix <i>pro</i>         | Embedded <i>pro</i> ...           |                                                         |
|-------------------------|---------------------------|-----------------------------------|---------------------------------------------------------|
|                         |                           | within CP                         | within DP                                               |
| PIVOT MOVEMENT          | Voice-agreeing dependency | Long-distance voice-agreeing dep. | <i>Impossible</i><br>(no DP-internal Agr <sup>0</sup> ) |
| GENITIVE INVERSION      | Genitive agent dependency | Long-distance genitive agent dep. | Subextraction dependency                                |

Having explored the possibilities of satisfying the locality requirement through movement, let us now turn to the next section, where we will see that locality can also be satisfied without movement if the structures involved are syntactically reduced.

## 6.5 Free dependencies

I refer to the third and final subclass of non-agreeing DP dependencies as the free dependency subclass. We find this subclass of dependencies with types of clauses that characteristically do not mark nominative on any of their arguments, particularly RECENT PERFECTIVE clauses and EXCLAMATIVE ADJECTIVE clauses. These types of clauses are associated with specific semantic interpretations and show evidence of reduced

syntactic structure, diagnosed primarily by the reduced compatibility of a number of left-peripheral operations such as negation, focus fronting, and significantly genitive inversion. I show in this section that this reduced syntactic structure results in greater number of positions being valid targets for (DP) A'-dependency formation.

The most salient example of this kind of dependency involves recent perfective (RPFV) clauses, which expresses the recent completion of an event, shown in (101). This clause type contrasts with other types of verbal clauses in Tagalog in standardly not marking nominative on any of its arguments and not having voice morphology on the verb. Nevertheless, it allows extraction of not only the external argument, as we might expect from the previous sections, but also the internal argument (see also McGinn 1988; Schachter 1996).

## (101) RECENT PERFECTIVE

- a. Kai~inom lang **ng** bisita **ng** tubig.  
RPFV~drink only GEN guest GEN water  
'The guest has just drunk water.' Baseline
- b. B<in>igy-an ko ng kendi ang bisita=ng [kai~inom lang ng tubig].  
<PFV>give-LV 1SG.GEN GEN candy NOM guest=LK RPFV~drink only GEN water  
'I gave candy to the guest who has just drunk water.' Agent Relative Clause
- c. Ni-lagy-an ko ng lemon ang tubig na [kai~inom lang ng bisita].  
PFV-put-LV 1SG.GEN GEN lemon NOM water LK RPFV~drink only GEN guest  
'I had put lemon in the water that the guest has just drunk.' Theme Relative Clause

In addition to recent perfectives, we also find a number of exclamative adjective forms that show similar behavior. In (102), we have an example showing adjectives marked with the prefix *napaka-* which I gloss as *very* (see also Kroeger 1993, pp.48–54). Like RPFV clauses, clauses with *napaka-*adjective predicates do not mark nominative on the subject (or any internal arguments). This contrasts with the behavior of regular declarative adjectives, shown in (103), which *do* mark their subjects nominative. Despite the subject of the *napaka-*adjective lacking nominative marking, we see in (102b) that it may nevertheless be targeted for an A'-dependency.

(102) *Napaka-* EXCLAMATIVE ADJECTIVE

- a. Napaka-hilig **ng** mga Pinoy sa kanin!  
very-fond GEN PL Filipino OBL rice  
'Filipinos are very fond of rice!' Baseline
- b. Na-kita ko ang pinsan mo=ng [napaka-hilig sa kanin].  
NVOL.PFV-see[PV] 1SG.GEN NOM cousin 2SG.GEN=LK very-fond OBL rice  
'I saw your cousin [who is very fond of rice].' Relative Clause

(103) Ma-hilig **ang** mga Pinoy sa kanin.

ADJ-fond NOM PL Filipino OBL rice

‘Filipinos are fond of rice.’

Declarative adjectival predicate

These dependencies are distinct from the previous two subtypes of non-agreeing DP dependencies in a handful of ways. First, while the first two subtypes, particularly genitive agent dependencies, may be judged marginal at times by many speakers, free dependencies are judged more consistently to be grammatical. Second, they show less restricted behavior in comparison to the other two subtypes. That is, the structural asymmetry in the arguments that can be targeted no longer holds. In other words, genitive-marked internal and external arguments are equally valid targets for A'-dependencies, as can be seen with RPFV clauses (but not exclamatives).

In this section, I propose that the same *pro*-based mechanism that derives the DP A'-dependencies that we have seen so far also accounts for the behavior of free dependencies. The major difference in this case is that reduced structure allows *pro* to appear in a wider range of positions while still being sufficiently local to the clause-edge operator. To begin, I first present evidence for the reduced nature of the clause types that allow the formation of free dependencies (henceforth, *free dependency clauses*).

### 6.5.1 The reduced nature of free dependency environments

Free dependency clauses exhibit behavior that suggests they are syntactically reduced or defective in some way. The first of these behaviors, which has already been mentioned, is the lack of nominative Case assignment, despite the apparently clausal structure. The examples in (104) show that nominative Case is ungrammatical both in RPFV clauses (*pace* Odango and Otsuka 2015), as well as in the three exclamative forms—marked *ang*, *kay*, and *napaka*—that I focus on in this chapter. These exclamative forms will be introduced more thoroughly in Section 6.5.3. I take the lack of nominative Case in these clauses to indicate the lack of Agr<sup>0</sup>. For RPFV clauses, the lack of voice morphology (otherwise typically present on verbs) is also an indicator for the lack of Agr<sup>0</sup>.

(104) NO NOMINATIVE CASE IN FREE DEPENDENCY CLAUSES

a. Kasa~sara {**ko** /\*ako } lang {**ng** /\*ang } pinto.

RPFV~close 1SG.GEN 1SG.NOM only GEN NOM door

‘I have just closed the door.’

Recent Perfective

b. {Ang /Kay /Napaka-}hirap buks-an {**ng** /\*ang } pinto=ng ito.

*ang kay* very- difficult open-LV GEN NOM door=LK PROX

‘This door is {so/very} hard to open.’

Exclamatives

Furthermore, we also find that a number of constructions that make use of the clausal left periphery are incompatible with these clause types. First, sentential negation is incompatible, or at least marked, in free dependency clauses, as shown in (105).<sup>41</sup> Minimally different non-free-dependency clauses are

<sup>41</sup>Although Sabbagh (2005, p.106) claims that negation in recent perfective is merely marked, not ungrammatical, saying that such examples improve when uttered in a context. I have not been able to replicate this datapoint.



provided for comparison in (106), where we see that sentential negation *is* possible. I take this data to be evidence for the absence of NegP in free dependency environments.<sup>42</sup>

## (105) NO NEGATION WITH FREE DEPENDENCY ENVIRONMENTS

- a. \*Hindi ko lang kaba~basa ng liham gáling kay Nestor.  
 NEG 1SG.GEN only RPFV~read GEN letter from OBL.P Nestor  
 Intended: 'I have not just read a letter from Nestor.' RPFV
- b. \*Hindi {ang /kay /napaka-}galíng ng lola ko sa golf!  
 NEG ang kay very- skill GEN grandmother 1SG.GEN OBL golf  
 Intended: 'It's not the case that my grandmother is {so/very} good at golf!' Exclamative

## (106) NEGATION WITH NON-FREE-DEPENDENCY CLAUSES

- a. Hindi ko ba~basah-in ang liham gáling kay Nestor.  
 NEG 1SG.GEN FUT~read-PV NOM letter from OBL.P Nestor  
 'I will not read the letter from Nestor.' Voice-marked clause
- b. Hindi ma-galíng ang lola ko sa golf!  
 NEG ADJ-skill NOM grandmother 1SG.GEN OBL golf  
 'My grandmother is not good at golf!' Declarative adjective

An alternative view of these facts might argue that the ill-formedness of negation is better understood as a semantic effect. For example, if we assume that the actual asserted meaning of these expressions without negation is very specific (e.g., that the completion time of an event was recent), then negation would result in a denotation that would be almost vacuously true, and consequently an utterance that is uninformative to the point of unacceptability. There is some evidence for this with RPFV, as discussed briefly in Section 7.3.6, where a salient reading of an RPFV *why* question is one that asks for a reason for only the recentness of the action, not for the action in general, as exemplified in (107a). The intuition would then be that negating this statement of recentness might result in something highly uninformative (i.e., 'It is not just now that you've read that letter.'). explaining the ungrammaticality of (105a). However, it is not clear whether a similar explanation appealing to semantic vacuity can be applied to exclamative adjective forms such as (107b). Following this reasoning, I take the behavior shown with negation in (105) as one piece of evidence indicating reduced structure.

## (107) 'WHY' QUESTIONS

- a. Bakit kaba~basa mo lang ng liham na iyan?  
 why RPFV~read 2SG.GEN only GEN letter LK MED  
 'Why is it just now that you've read that letter?' RPFV
- b. Bakit ang galíng ng lola mo sa golf?  
 why ang skill GEN grandmother 2SG.GEN OBL golf  
 'Why is your grandmother so good at golf?' Exclamative

<sup>42</sup>Alternatively, given the speculation in fn.16, these constructions may instead lack FinP.

Moving higher in the clause periphery, we see that focus fronting of non-DPs out of these clauses is ill-formed. Compare the ungrammatical examples in (108), showing RPFV and exclamative adjectives, to the grammatical examples in (109) with a regular voice-marked verbal predicate and a plain declarative adjective. I take this contrast as evidence for the absence of the left-peripheral focus projection FocP, the general existence and position of which I discuss in more detail in Chapter 7.

## (108) UNGRAMMATICAL FOCUS FRONTING FROM FREE DEPENDENCY ENVIRONMENTS

- a. \*{Saan /Sa probinsya} lang kau~uwi ni Matthew.  
 where OBL province only RPFV~go.home GEN.P Matthew  
 Intended: 'Where has Matthew just returned to?'  
 Intended: 'It's to the provinces (i.e., a rural area) that Matthew has just returned to.'" RPFV
- b. \*{Kanino /Sa bago=ng mag-aarál} {ang /kay /napaka-}saya ng guro  
 who.OBL OBL new=LK student ang kay very- happy GEN teacher  
 Intended: 'Who is the teacher {so/very} happy with?'  
 Intended: 'It's the new student that the teacher is {so/very} happy with.'" Exclamative

## (109) GRAMMATICAL FOCUS FRONTING IN NON-FREE-DEPENDENCY CLAUSES

- a. {Saan /Sa probinsya} u~uwi si Matthew.  
 where OBL province FUT~go.home[AV] NOM.P Matthew  
 'Where is Matthew going to return to?'  
 'It's to the provinces (i.e., a rural area) that Matthew is going to return.'" Voice-marked clause
- b. {Kanino /Sa bago=ng mag-aarál} ma-saya ang guro  
 who.OBL OBL new=LK student ADJ-happy NOM teacher  
 'Who is the teacher happy with?'  
 'It's the new student that the teacher is happy with.'" Declarative adjective

Significantly, the ill-formedness of focus fronting in (108) is not simply due to having used the wrong construction. The pseudocleft strategy is also not available for focusing non-DPs in free dependency environments, even though it is available for the (genitive-marked) DPs. This fact is shown in (110) for pseudocleft questions, but declarative pseudoclefts show the same behavior as well. Note that the examples below are ungrammatical regardless of the case marking (oblique or nominative) of the focus constituent, and that DP pseudoclefts are generally possible as (111) shows for *kay*- and *napaka*-exclamatives.<sup>43</sup> We will see later in Section 6.5.3 that *ang*-exclamatives cannot form DP A'-dependencies.

## (110) NO NON-DP PSEUDOCLEFTS IN FREE DEPENDENCY CLAUSES

- a. \*{Saan /Ano } ang kau~uwi lang ni Matthew?  
 where(OBL) what(NOM) NOM RPFV~go.home only GEN.P Matthew  
 Intended: 'Where has Matthew just returned to?' Recent Perfective

<sup>43</sup>As I argue in Section 7.1.3, this evidence shows us that the distinction between DP and non-DP A'-dependencies in Tagalog is intrinsically tied to the DP- or non-DP-hood of the targets, and not to some secondary factor.

- b. \*{Kanino /Sino } ang {ang /kay /napaka-}saya ng guro?  
 who.OBL who.NOM NOM *ang kay* very- happy GEN teacher

Intended: 'Who is the teacher {so/very} happy with?'

Exclamative

(111) DP PSEUDOCLEFTS IN FREE DEPENDENCY CLAUSES

- a. Sino ang kau~uwi lang sa probinsya?  
 who.NOM NOM RPFV~go.home only OBL province

'Who has just returned to the provinces?'

Recent Perfective

- b. Sino ang {<sup>?</sup>kay /napaka-}saya sa bago=ng mag-aarál?  
 who.NOM NOM *kay* very- happy OBL new=LK student

'Who is {so/very} happy with the new student?'

Exclamative

Finally, and in contrast to the genitive agent and subextraction dependencies, free dependency clauses do not allow genitive inversion. We can see this for RPFV clauses in (112), which shows that the pronominal non-pivot agent must remain post-verbal as *ko* and cannot surface pre-verbally as *akin*. An example of genitive inversion with a voice-marked clause is also provided for comparison.

(112) NO GENITIVE INVERSION IN RECENT PERFECTIVE

- a. Kaba~basa **ko** lang ng liham gáling kay Nestor.  
 RPFV~read 1SG.GEN only GEN letter from OBL Nestor

'I have just read a letter from Nestor.'

Baseline

- b. \***Aki[n]=ng** kaba~basa lang ng liham gáling kay Nestor  
 1SG.OBL=LK RPFV~read only GEN letter from OBL Nestor

Intended: 'I have just read a letter from Nestor.'

\*Genitive inversion

- c. **Aki[n]=ng** ba~basah-in ang liham gáling kay Nestor  
 1SG.OBL=LK FUT~read-PV NOM letter from OBL Nestor

'I will read the letter from Nestor.'

Genitive inversion with voice-marked clause

To the extent that we can test the compatibility of genitive inversion in adjectival contexts, the examples in (113) show that it is also impossible. Again, we see that the genitive pronoun cannot invert to the clause-initial position. In the case of adjectives, however, we have no point of comparison where genitive inversion is licit, as genitive pronouns do not appear with adjectives that assign nominative to their subjects. Interestingly, Sabbagh (2005, chap.4) argues that adjectives that are compatible with *napaka-* have an unergative argument structure. That is, their subjects are external arguments in the same sense that agents and possessors are. We might then expect that the subjects of such adjectives should be able to invert, contrary to what we see in (113).

## (113) NO GENITIVE INVERSION WITH EXCLAMATIVE ADJECTIVES

- a. {Ang /Kay /Napaka-}galíng **niya** sa golf!  
*ang kay very- skill 3SG.GEN OBL golf*

‘She’s {so/very} good at golf!’

Baseline

- b. \***Kanya=ng** {ang /kay /napaka-}galíng sa golf!  
*3SG.OBL=LK ang kay very- skill OBL golf*

Intended: ‘She’s {so/very} good at golf!’

\*Genitive inversion

We thus see that a number of higher projections along the clausal spine from AgrP up are missing from the derivation, with the consequence that free dependency environments have drastically reduced structure compared to their regular counterparts. The intuition I pursue here, then, is that this reduced structure allows for freer movement of argument DPs, eliminating the structural asymmetry we have seen for the previous subtypes of non-agreeing DP dependencies. In particular, this reduced structure will allow even an internal argument *pro* to escape its base position and receive nominative Case. I formalize this in the next subsections.

## 6.5.2 Dependencies with Recent Perfective

Here I present the derivation of free dependencies with RPFV clauses, which I propose proceeds slightly differently from what we have seen with the previously discussed DP A'-dependencies. As with these previous examples, I assume that *pro* is introduced in the relevant thematic position, to be bound by a clause-edge operator. Where the difference lies for the constructions discussed in this section is in how the posited locality requirement on binding *pro* is satisfied. Instead of needing to move to achieve locality as we have seen previously, I propose here that the reduced structure of free dependency clauses allows *pro* to be bound in-situ. Formalizations of the reduced structure are also proposed here.

Let us begin with the derivation for RPFV clauses. I assume that the general structure for this clause type resembles its voice-marked counterparts up to the *vP* projection. This is because, as discussed previously in Section 3.1, RPFV clauses are compatible with argument-introducing heads like *pa-*, as shown by the RPFV causative example in (114).

- (114) Kapa~**pa**-ayos ko lang kay Benjie ng relo=ng ito.  
*RPFV~CAUS-fix 1SG.GEN only OBL.P Benjie GEN wristwatch=LK PROX*

‘I {have/had} just made Benjie fix this watch.’

Following the discussion in the previous subsection, I assume that AgrP and higher projections are absent in RPFV clauses. This assumption raises the question of what syntactic head might correspond to the *ka+RED* morphology that marks this form. One possible approach, which I assume for concreteness, is that this morphology is the reflex of a syntactic head occupying a position on the clausal spine between AgrP and *vP* that is associated roughly with telic events or result states. Supporting evidence for this approach comes from a number of constructions where *ka-* surfaces.

First, we have a morphologically identical construction to RPFV shown in (115a) that has the syntactic distribution of a nominal. This construction means something to the effect of “having done X to an extreme extent” and usually appears as an oblique-marked adjunct. *Ka-* also appears in AV forms of the non-volitional (or ability/involuntary action) verb form, as pointed out by Travis (2000a). An example is given in (115b). Dell (1983) shows that this verb form is used to express culminating accomplishments (or telic events), in contrast to the so-called neutral form, which expresses non-culminating accomplishments, and which constitutes most of the verbal examples in this thesis. Finally *ka-* also appears in gerund forms that denote result states (see also Schachter and Otnes 1972, §3.26, where these forms are called *perfective gerunds*). We see in (115c) an example, *pagkasulat*, that is compatible with an adjective describing the result state of the writing, but not the process. Compare this with *pagsulat* in (116), which shows the opposite pattern.

(115) OTHER ENVIRONMENTS WITH *ka-*

a. Na-ubos ang tinta ng bolpen [sa {kaka-sulat/kasu~sulat} ko ng liham].  
 PFV-USE.UP NOM ink GEN pen OBL *kared*-write *kared*~write 1SG.GEN GEN letter  
 ‘The pen’s ink ran out [from all my writing of letters].’ *sa kaka-* construction

b. Naka-inom si Juan ng alak.  
 AV.NVOL.PFV-drink NOM.P Juan GEN liquor  
 ‘Juan {managed to drink/accidentally drank} liquor.’ Non-volitional form

c. {Ma-ganda/\*?Ma-bilis } ang pag-ka-sulat niya ng liham.  
 ADJ-beauty ADJ-speed NOM *pag-ka*-write 3SG.GEN GEN letter  
 ‘Their<sub>SG</sub> writing of the letter was {beautiful/\*fast}.’  
 ≈‘They<sub>SG</sub> wrote the letter beautifully.’ Result gerund

(116) {\*?Ma-ganda/Ma-bilis } ang pag-Ø-sulat niya ng liham.  
 ADJ-beauty ADJ-speed NOM *pag-Ø*-write 3SG.GEN GEN letter  
 ‘Their<sub>SG</sub> writing of the letter was {\*beautiful/fast}.’  
 ≈‘They<sub>SG</sub> wrote the letter quickly.’ Event gerund (cf. 115c)

These examples also show us that *ka-* can co-occur with Agr<sup>0</sup>, as with the AV non-volitional form in (115b), but can also surface in voiceless (i.e., Agr<sup>0</sup>-less) environments, as in (115a) and (115c). The causative example (114) furthermore shows that such voiceless environments may nevertheless contain overt instances of *v*<sup>0</sup>. I thus assume the structure given in (117) for the RPFV clause in (114), where *ka*+RED spells out the head that I label Tel<sup>0</sup>.<sup>44</sup>

<sup>44</sup>For the purposes of this thesis, I assume that CV-reduplication is part of the spell-out of Tel<sup>0</sup>, although it is more likely that this reduplication spells out a different syntactic head altogether. For example Travis (2000a, et seq.) proposes that this morpheme corresponds to an inner aspect head. Alternatively Schachter and Otnes (1972, pp.160–1) tie the presence or absence of this morpheme in gerunds (which, like RPFV, are voiceless) to whether or not the corresponding AV form is marked with *mag-* (instead of <*um*>). Following other work on the Tagalog *mag-/<um>* alternation (e.g., Travis 2000a), we might take this instance of reduplication to be tied to transitivity.

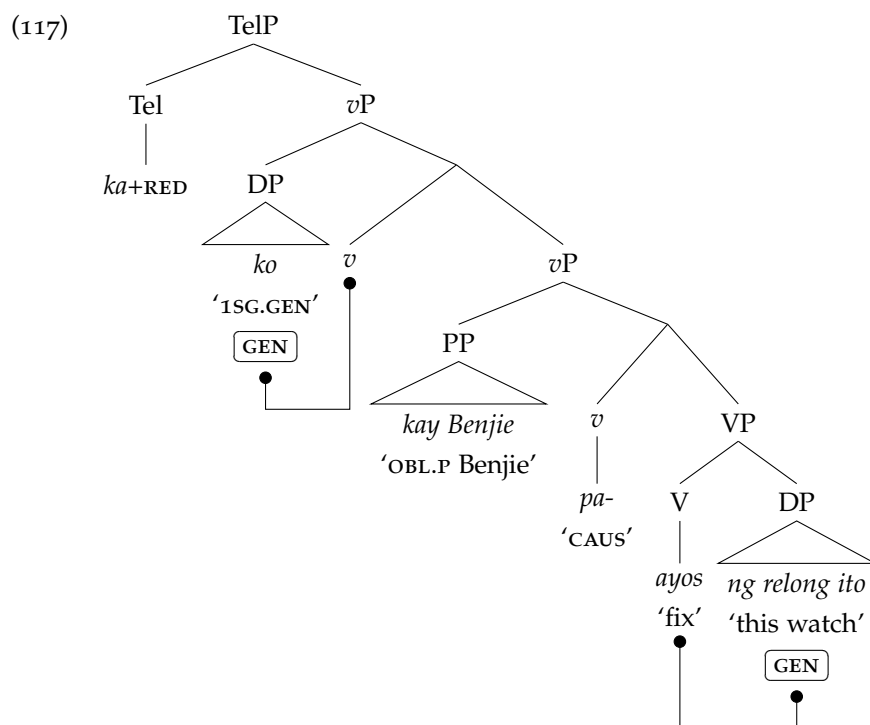

I assume that (117) shows the upper limit of structure found in RPFV clauses. That is, RPFV clauses lack the structure of the inflectional domain (e.g., AgrP, IP), as well as the left-peripheral domain (e.g., NegP; FocP for focus fronting, see Chap. 7; InvP for genitive inversion, see Secs. 6.2.4–6.2.5). This radically reduced structure of RPFV clauses has implications for the *pro*-based formation strategy for DP A'-dependencies. Specifically, I argue that because of this reduced structure, *pro* generated within the thematic domain (*vP*) of a clause does not need to undergo movement to a higher position in order to be local to the high  $\lambda$ -operator. In fact, neither of the operations previously proposed to allow *pro* to escape the thematic domain—pivot movement or genitive inversion—are available in RPFV clauses. In other words, *pro* can (or must) be bound in-situ, deriving the increased freedom we find in RPFV clauses.

Straightforwardly, I propose to derive relative clauses from the structure (117) by the generation of *pro* in the relevant thematic position and by  $C^0$  directly selecting TelP. Following the proposal first introduced in Section 5.3, I assume that the introduction of  $C^0$  also introduces a  $\lambda$ -operator to the structure that binds *pro*. (118) shows the relevant structure for a theme relative clause. With this binding established, the derivation can continue on as we have previously seen (e.g., composing with a nominal expression, etc.).

(118) THEME RELATIVIZATION WITH RPFV CLAUSE

- a. Na-sira na naman ang relo=ng [kapa~pa-ayos ko lang kay Benjie]  
 PFV-break again NOM wristwatch=LK RPFV~CAUS-fix 1SG.GEN only OBL.P Benjie  
 'The wristwatch [that I had just made Benjie fix] broke again!'

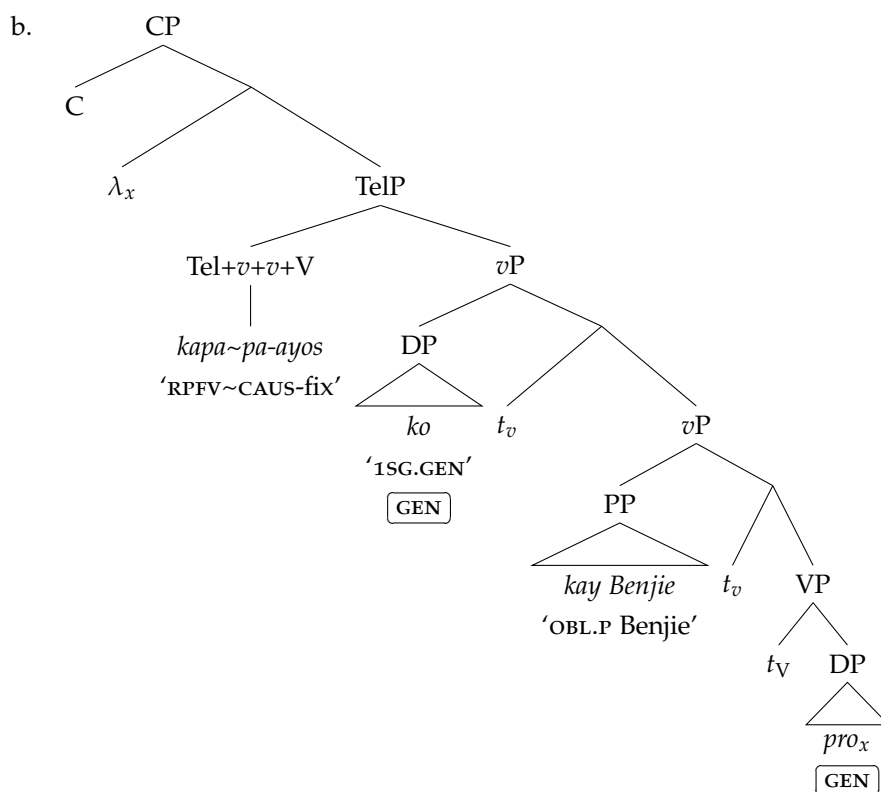

The behavior of RPFV clauses thus expands our understanding of the nature of *pro*, the clause-edge operator, and the proposed locality requirement on their binding. As previously discussed, the exact nature of this locality requirement remains a mystery, and I am unable to provide a concrete formalization of it. However, I hope to have thus far shown that the generalizations surrounding this locality requirement are robust and that there are multiple ways to satisfy it (i.e., pivot movement, genitive inversion, reduced structure). In Section 6.6, I summarize the data we have seen so far and speculate on potential ways to formalize the proposed locality requirement. For now, let us turn to another type of construction, the exclamative adjectives, that I argue also allow freer binding of *pro* through reduced structure.

### 6.5.3 Background on (exclamative) adjectives

We now turn to the behavior of exclamative adjectives. I first present some relevant background on the exclamative adjective forms, comparing them with other non-exclamative forms. We will see that in addition to the morphological and Case-assigning differences between these two types of adjectives, other structural differences are also detectable. We will also see that the exclamative adjective forms do not form a natural class in terms of their ability to function as nominal modifiers/relative clauses. While two of these forms—*napaka*- and *kay*-exclamatives—can be used in attributive modification, a third—*ang*-exclamatives—cannot. I argue that this asymmetry within the exclamative adjectives reflects differences in the amount of structure between the exclamative forms. Particularly, while I will show that *ang*-exclamatives have adjectival structure internally, their morphological form suggests the presence of an outer DP layer. I claim that this additional DP layer interferes with the required locality between *pro* and the  $\lambda$ -operator.

## 6.5.3.1 Predicative behavior

Tagalog has a number of morphological strategies for modifying the degree of an adjective. As we have seen with *napaka-* at the beginning of this section, some of these strategies have an exclamative flavor to them, and, more relevant for our purposes, assign genitive Case, not nominative, to their clausal subjects. We have also seen two other forms that show this behavior: the *ang*-exclamative and the *kay*-exclamative.<sup>45</sup> These exclamative forms are shown in (119). For comparison, (120) shows the corresponding regular declarative adjectival form as well as another morphological degree modification strategy that has the form “ADJ LK ADJ” and retains nominative Case on the subject.

## (119) GENITIVE-SUBJECT ADJECTIVE FORMS

- a. {Ang taba/Kay taba/Napaka-taba} **ng** pusa=ng ito!  
*ang* fat *kay* fat very-fat GEN cat=LK PROX  
 ‘This cat is {so/very} fat!’ / ‘How fat this cat is!’
- b. {Ang luma/Kay luma/Napaka-luma} na **ng** sapatos mo!  
*ang* old *kay* old very-old already GEN shoe 2SG.GEN  
 ‘Your shoes are {so/very} old now!’ / ‘How old your shoes are now!’

## (120) NOMINATIVE-SUBJECT ADJECTIVE FORMS

- a. Ma-taba(=ng ma-taba) **ang** pusa=ng ito.  
 ADJ-fat=LK ADJ-fat NOM cat=LK PROX  
 ‘This cat is (really) fat.’
- b. Luma(=ng luma) na **ang** sapatos mo.  
 old=LK old already NOM shoe 2SG.GEN  
 ‘Your shoes are (really) old.’

Comparing (119) and (120), we also see that the morphemes *ang*, *kay*, and *napaka-* attach to adjectival stems, replacing the prefix *ma-*. The *ma-* prefix marks the plain declarative form of many but not all basic adjectives in Tagalog, and its distribution within this class of adjectives appears to be lexically determined (see also Schachter and Otnes 1972, §4.2–3). Thus, *mataba* is the correct adjectival form, but *taba* on its own refers either to the abstract notion of fatness or to “physical” fat (e.g., lard, grease, oil). On the other hand, we have *luma*, while *\*maluma* is unattested.

With respect to exclamative constructions, Sabbagh (2005, chap.4) also shows that not all adjectives can appear as such forms. He argues that this is not an issue of semantic gradability, but rather of argument structure. Contrasting what he terms unaccusative and unergative adjectives, he demonstrates that exclamatives may be formed from unergatives, which include the types of adjectives we have seen so far in this section. On the other hand, unaccusative adjectives like *pagód* ‘tired’ in (121) cannot form

<sup>45</sup>These adjectival forms are conventionally written with the marker as an orthographically separate word, in contrast to *napaka-* which is written as a prefix. However, these morphemes are most likely formally enclitics (like their homophonous noun-marker counterparts), if not prefixes. I leave the determination of their morphosyntactic status for future work.



exclamatives (121a), even though they are otherwise gradable through other constructions (121b).<sup>46</sup> This class of adjectives is thus set aside for this thesis.

(121) UNACCUSATIVE ADJECTIVES ARE INCOMPATIBLE WITH EXCLAMATIVES

- a. \*{Ang/Kay/Napaka-} pagód na ng sanggol.  
*ang kay* very tired already GEN baby

Intended: ‘The baby is {so/very} tired.’

- b. Pagód (na pagód) na ang sanggol.  
 tired LK tired already NOM baby

‘The baby is (really) tired.’

### 6.5.3.2 Modificational behavior

With the exception of the *ang*-exclamative, the adjective forms under discussion can also be used in attributive modification, as we see in (122). This behavior is expected for the plain declarative form and the linker-reduplicated (ADJ LK ADJ) form, but the behavior shown by the exclamatives presents something of a puzzle. Why can *kay*- and *napaka*-exclamatives, but not *ang*-exclamatives, function as modifiers?

(122) VARIOUS ADJECTIVAL FORMS AS NOUN MODIFIERS

- a. Ba~bawas-an namin ang pagkain ng pusa=ng [{\*ang/kay/napaka-/(ma~taba=ng)  
 FUT~reduce-LV 1PL.EXCL.GEN NOM food GEN cat=LK *ang kay* very- ADJ-fat=LK  
 ma-} taba pa rin daw].  
 ADJ- fat still also QUOT

‘We’re going to reduce the food of the cat [that is reportedly still ((so/very/really)) fat].’

- b. Dapat na=ng i-tapon ang sapatos mo=ng [{\*ang/kay/napaka-/luma=ng/Ø}  
 must already=LK CV-dispose NOM shoe 2SG.GEN=LK *ang kay* very- old=LK  
 luma na raw talaga].  
 old already QUOT truly

‘Your shoes that [are reportedly truly ((so/very/really)) old now] should be thrown away already.’

To illustrate the problem, it is helpful to consider that the line between adjectival and relative clause modification in Tagalog is blurry. Because both types of modification make use of the linker morpheme and Tagalog lacks an overt copula, we do not have straightforward evidence to say that apparent cases of adjectival modification are just that, or if they involve a fuller clausal structure. Thus, the modified NP *mga malalaking cookies* in (123) is equally plausibly translated as either ‘big cookies’ or ‘cookies that are big’. Furthermore, (123-124) show that both types of modification use the linker morpheme and have similar word-order patterns that are sensitive to the syntactic size of the modifier.

<sup>46</sup>Sabbagh’s (2005) unaccusative adjectives are reminiscent of adjectival passives and appear to correspond to the first subclass of what Schachter and Otones (1972, §4.2) call the unaffixed adjectives. Schachter and Otones observe that adjectives of this class are transparently related to (or derived from) a noun or verb via vowel length reduction (or stress shift). For example, the adjective *pagód* ‘tired’ corresponds to the noun *págod* ‘tiredness’, which also appears verbally as *mapágod* ‘to become tired’.

## (123) MODIFIERS REQUIRE THE LINKER AND SHOW FLEXIBLE WORD ORDER

- a. Ma-init pa ang mga {g<in>awa ko /ma-la~laki}=ng cookies.  
 ADJ-hot still NOM PL <PFV>make[PV] 1SG.GEN ADJ-PL~big cookies  
 ‘The {big cookies/cookies that are big/cookies that I made} are still hot.’
- b. Ma-init pa ang mga cookies na {g<in>awa ko /ma-la~laki}.  
 ADJ-hot still NOM PL cookies LK <PFV>make[PV] 1SG.GEN ADJ-PL~big  
 ‘The {big cookies/cookies that are big/cookies that I made} are still hot.’

## (124) PREFERENCE FOR HEAVY MODIFIERS TO BE POST-NOMINAL

- a. Nag-bakasyon ang babae=ng [{nagla~laro ng /ma-galíng sa } golf].  
 AV.PFV-vacation NOM woman=LK AV.IMPF~play GEN ADJ-skill OBL golf  
 ‘The woman [who {plays/is good at} golf] went on vacation.’
- b.<sup>??</sup> Nag-bakasyon ang [{nagla~laro ng /ma-galíng sa } golf] na babae.  
 AV.PFV-vacation NOM AV.IMPF~play GEN ADJ-skill OBL golf LK woman  
 ‘The woman [who {plays/is good at} golf] went on vacation.’

However, some hints of a distinction can be found with non-intersective adjectives like *dati* ‘former’. As (125) shows, such adjectives do not have a predicative use, as expected. Furthermore, (126) shows that in modificational contexts, *dati* may only appear pre-nominally. Straightforwardly, this suggests that if true adjectival modification exists in Tagalog, then it must use the prenominal position. Consequently, if a modifier appears post-nominally, then it must be a relative clause (i.e., not true adjectival modification). Note that this conclusion is compatible with the post-nominal preference for heavy modifiers shown in (124), as well as the possibility for post-nominal modifiers to include adverbial material that is presumably introduced at the clause level, such as the reportative clitic *daw* in (122).<sup>47</sup>

- (125) \*Dati ang presyo ng bawang na ito.  
 former NOM price GEN garlic LK PROX  
 Intended: ‘This price of garlic is former.’

## (126) WORD ORDER RESTRICTION FOR NON-INTERSECTIVE ADJECTIVES

- a. Mas ma-bábà ang **dati=ng** presyo ng bawang.  
 more ADJ-low NOM former=LK price GEN garlic  
 ‘The former price of garlic is lower.’
- b. \*Mas ma-bábà ang presyo=**ng dati** (ng bawang).  
 more ADJ-low NOM price=LK former GEN garlic  
 Intended: ‘The former price (of garlic) is lower.’

I will thus take as an operational assumption that modifiers appearing post-nominally have a relative clause structure. Under this relative clause lens, we can recast the question of the contrast between

<sup>47</sup>However, (123) seems to suggest that the pre-nominal position can also be occupied by relative clauses.

*ang*-exclamatives and *napaka-/kay*-exclamatives as one involving *pro*. Specifically, why is the binding of *pro* successful when it is the subject of a *kay*- or *napaka*-exclamative, but not when it is the subject of an *ang*-exclamative?

To account for the behavior of *kay*- and *napaka*-exclamatives, I follow the approach previously taken for RPFV clauses, and assume that these exclamatives have reduced structures (as argued in Section 6.5.1). This reduced structure means that *pro* introduced as the subject of an exclamative adjective is sufficiently local to the clause edge without undergoing movement. Subsequently, it may be bound by the  $\lambda$ -operator in-situ. In drawing this parallel, a major difference between RPFV clauses and exclamative adjective constructions should be noted. In the latter, we typically only find a single DP argument, corresponding to the subject of the clause. As we have seen in examples like (123), complements of adjectives are prepositional and bear oblique marking.<sup>48</sup> Thus, the exclamative adjectives do not provide us the correct environment for testing or detecting the predicted increased flexibility of relativization that we saw with RPFV clauses, which can have two DP arguments.

However, what the exclamative adjectives *do* show us is an environment where reduced internal structure leads to reduced movement possibilities (i.e., pivot movement and genitive inversion), but additional external structure interferes with locality between *pro* and the  $\lambda$ -operator. This environment is the *ang*-exclamative. As argued in Section 6.5.1, these also have reduced structures in a similar way to the other two exclamative constructions. Nevertheless, *ang*-exclamatives cannot be used attributively, so some property specific to them must be responsible for blocking the binding of *pro*. A way forward is strongly suggested by the form of the *ang*-exclamative. That is, the *ang*-marking on these constructions is homophonous with the nominative common noun determiner *ang*, suggesting that these exclamative constructions involve a DP layer. Crucially, I show in the next subsection that the DP status of *ang*-exclamatives is different from more typical DPs in Tagalog, which we have seen allow subextraction dependencies (Sec. 6.4). Specifically, I will show that despite the presence of *ang*, the internal structure of these exclamatives is still adjectival, as they show certain adjectival behaviors that are not possible with true nominal constructions. Thus, these cases should be distinguished from true DPs, which we have seen. After discussing the adjectival/non-nominal properties found in *ang*-exclamatives, I discuss in detail the analysis for exclamative adjectives.

### 6.5.3.3 The *ang*-exclamative is not totally nominal

Given the form of the *ang*-exclamative, a natural first instinct might be to posit that these are formally DPs that are used in an exclamative manner (see, e.g., Nagaya 2011, §2.6). Under such a view, the “subject” of the adjective is its possessor, explaining its genitive marking. This alternative view is illustrated by the second free translation in (127). This view is further supported by the fact that the string in (127) can appear in other nominal positions, whether *ang*-marked or otherwise. In such cases, shown in (128), we have the expected nominal interpretation, and not the exclamative one.

<sup>48</sup>Schachter and Otones (1972, pp.247–8) list a handful of adjectives in Tagalog that do take genitive-marked complements. However, these appear to be incompatible with the exclamative expressions under discussion.

## (127) EXCLAMATIVE ADJECTIVE OR EXCLAMATIVE DP?

Ang galíng ni lola sa golf!

*ang* skill GEN.P grandma OBL golf

‘Grandma is so good at golf!’

‘Grandma’s skill at golf!’

## (128) “EXCLAMATIVE ADJECTIVE” IN NOMINAL ENVIRONMENTS

a. Na-kita namin [ang galíng ni lola sa golf].

NVOL.PFV-see[PV] 1PL.EXCL.GEN NOM skill GEN.P grandma OBL golf

‘We saw [Grandma’s skill at golf].’

b. Na-gulat kami [sa galíng ni lola sa golf].

PFV-surprise 1PL.EXCL.NOM NOM skill GEN.P grandma OBL golf

‘We were surprised by [Grandma’s skill at golf].’

Under this view of *ang*-exclamatives as a typical nominal that has a conventionalized exclamative interpretation, we predict that this construction should show other nominal behaviors. In particular, we expect from the discussion on subextraction dependencies that A'-dependencies targeting the possessor (i.e., the genitive-marked subject) of the exclamative construction should be possible, as the DP-internal mechanisms for establishing locality between *pro* and the  $\lambda$ -operator should be the same. This expectation is not borne out. Compare the examples in (129) which show that with the same string, subextraction is possible in a typical nominal context (i.e., pivot/argument) position, whereas the same attempted “subextraction” is impossible in an environment associated with the exclamative interpretation (as we saw in Sec. 6.5.3.2).

(129) “SUBEXTRACTION” IS NOT POSSIBLE FOR *ang*-EXCLAMATIVES

a. <sup>?</sup>K<in>ausap ko ang atleta=ng [na-pansin ko [ang galíng sa golf]].

<PFV> speak.with[PV] 1SG.GEN NOM athlete=LK NVOL.PFV-notice[PV] 1SG.GEN NOM skill OBL golf

‘I spoke to the athlete [who I noticed (her) skill in golf].’

Subextraction in a true DP

b. \*K<in>ausap ko ang atleta=ng [ang galíng sa golf].

<PFV> speak.with[PV] 1SG.GEN NOM athlete=LK *ang* skill OBL golf

Intended: ‘I spoke to the athlete [who is so good at golf].’

*Ang*-exclamative

The contrast in (129) thus suggests that there must be some difference between *ang*-exclamatives and the string-identical full DPs. Here, I present three pieces of evidence arguing that the internal structure of the *ang*-exclamative in (127) is different from that of string-identical regular nominal constituents like in (128). Thus, while *ang*-exclamatives may have historically originated as a nominalization of some kind, their internal structure in the modern language is in fact adjectival.

The first piece of evidence for the adjectival internal structure of *ang*-exclamatives comes from adjectival number agreement. We see in (130a) that regular declarative adjectives may optionally agree in number with a plural subject through CV-reduplication of the stem; (130b) confirms that this optional

plural agreement is only possible if the subject is overtly marked plural. We observe the same pattern in *ang*-exclamatives, as (131) demonstrates.<sup>49</sup>

## (130) NUMBER AGREEMENT IN ADJECTIVES

- |                                                                                              |                                                                          |
|----------------------------------------------------------------------------------------------|--------------------------------------------------------------------------|
| a. Ma-( <b>ta~</b> )taba ang mga pusa.<br>ADJ-PL~fat    NOM PL    cat<br>'The cats are fat.' | b. Ma-*(ta~)taba ang pusa.<br>ADJ-PL~fat    NOM cat<br>'The cat is fat.' |
|----------------------------------------------------------------------------------------------|--------------------------------------------------------------------------|

(131) NUMBER AGREEMENT IN *ang*-EXCLAMATIVES

- |                                                                                                        |                                                                                    |
|--------------------------------------------------------------------------------------------------------|------------------------------------------------------------------------------------|
| a. Ang ( <b>ta~</b> )taba ng mga pusa!<br><i>ang</i> PL~fat    GEN PL    cat<br>'The cats are so fat!' | b. Ang *(ta~)taba ng pusa!<br><i>ang</i> PL~fat    GEN cat<br>'The cat is so fat!' |
|--------------------------------------------------------------------------------------------------------|------------------------------------------------------------------------------------|

In contrast, this kind of CV-reduplication is ill-formed in string-identical constituents that appear in clearly nominal contexts. For example, see (132) where the string in (131a) serves as an argument to a verb like *napansin* 'noticed (PV)'. Only the non-reduplicated form is grammatical, despite the relevant nominal *pusa* 'cat' being marked plural. I take this to be evidence that the root *taba* 'fat' functions as an adjective in the exclamative construction, but not in the argument context of (132).

## (132) NO NUMBER AGREEMENT IN ARGUMENT POSITIONS

- Na-pansin            namin            [ang \*(**ta~**)taba ng mga pusa].  
NVOL.PFV-notice[PV] 1PL.EXCL.GEN    NOM    PL~fat    GEN PL    cat  
'We noticed [the fat(ness) of the cats].'

Another process that may occur in *ang*-exclamatives but not in string-identical nominal constructions is bi-syllabic reduplication of the stem.<sup>50</sup> In *ang*-exclamatives, this reduplication has the effect of making the exclamation more emphatic in some way, as in (134). As with CV-reduplication, (134) shows that this kind of reduplication is also ill-formed in clearly nominal contexts.

(133) EMPHATIC BI-SYLLABIC REDUPLICATION IN *ang*-EXCLAMATIVES

- Ang **tali~talino** ng pusa!  
*ang*    RED~smart    GEN cat  
'The cat is so very smart!'

## (134) NO BI-SYLLABIC REDUPLICATION IN ARGUMENT POSITIONS

- Na-pansin            namin            [ang \*(**tali~**)**talino** ng pusa].  
NVOL.PFV-notice[PV] 1PL.EXCL.GEN    NOM    RED~smart    GEN cat  
'We noticed [the cat's intelligence].'

<sup>49</sup>For basic adjectives that do not take *ma-*, plural marking is unavailable in the declarative form (i), but is interestingly available in the *ang*-exclamative form (ii). I leave the account of this contrast for future work.

|                                                                                                                         |                                                                                                                                          |
|-------------------------------------------------------------------------------------------------------------------------|------------------------------------------------------------------------------------------------------------------------------------------|
| (i) *(Lu~)Luma na    ang mga sapatos mo.<br>PL~old    already    NOM PL    shoe    2SG.GEN<br>'Your shoes are all old.' | (ii) Ang (lu~)luma na    ng mga sapatos mo!<br><i>ang</i> PL~old    already    GEN PL    shoe    2SG.GEN<br>'Your shoes are all so old!' |
|-------------------------------------------------------------------------------------------------------------------------|------------------------------------------------------------------------------------------------------------------------------------------|

<sup>50</sup>Note a number of morphophonological details of this general reduplication strategy in Tagalog are not discussed as they are not relevant for current purposes. For details, see e.g., Schachter and Otanes 1972, §5.16. In roots with more than two syllables, full reduplication (e.g., *ang talino talino*) also seems to be possible to varying degrees, based on cursory Google search results.

Bi-syllabic reduplication thus sets the *ang*-exclamative apart from string-identical nominals. Unlike number agreement however, this particular bi-syllabic reduplication process appears to be specific to *ang*-exclamatives, and thus does not necessarily support the claim that *ang*-exclamatives have an adjectival internal structure. While a number of morphologically similar reduplication processes are possible in declarative adjectives, they differ in various ways from the process available to *ang*-exclamatives. In *ma*-adjectives, for example, bi-syllabic reduplication has a kind of softening or moderating effect, rather than an intensification or emphatic effect (see also Schachter and Otnes 1972, §4.13). This softening is illustrated by (135), which also shows a case where stress appears root-finally. Other contexts, such as the non-reduplicated declarative and reduplicated *ang*-exclamative in (136), preserve the penultimate stress of the root *ínit* ‘hot’.<sup>51</sup>

## (135) BI-SYLLABIC REDUPLICATION IN DECLARATIVE ADJECTIVES

Ma-ínit-ínit pa ang sabaw.

ADJ-hot-hot still NOM soup

‘The soup is still somewhat hot.’

## (136) STRESS PLACEMENT IN OTHER ADJECTIVAL CONSTRUCTIONS

a. Ma-{ínit/\*ínit} pa ang sabaw.

ADJ- hot hot still NOM soup

‘The soup is still hot.’

b. Ang {ínit ínít/\*ínit ínít} pa ng sabaw!

*ang* hot hot hot hot still GEN soup

‘The soup is still so hot!’

Aside from these adjective-like properties shown by *ang*-exclamatives, we also find that these constructions do *not* show properties that are otherwise shown by DPs. Thus, our final piece of evidence comes from genitive inversion. We saw previously in Section 6.5.1 that genitive pronouns in an *ang*-exclamative could not undergo inversion to a pre-*ang* position. Given this apparent parallelism with true DPs, we can also ask about the possibility of inversion to a post-*ang* position. Recall that in true DPs, possessor pronouns may either appear as genitive clitics appearing after the head noun, or as oblique pronouns preceding the head noun. We see in (137) that this alternation is possible with true DPs that are string-identical to *ang*-exclamatives; the pronominal possessor may surface after *galíng* ‘skill’ or before it (but crucially after *ang*).

## (137) GENITIVE INVERSION IN ARGUMENT POSITIONS

a. I-p<in>a-kita niya sa amin [ang galíng niya sa golf].

CV-<PFV>CAUS-SEE 3SG.GEN OBL 1PL.EXCL.OBL NOM skill 3SG.GEN sa golf

<sup>51</sup>Perhaps a closer instance of this process can be found with the unaffixed or unaccusative adjectives briefly discussed in (121). Schachter and Otnes (1972, p.234) note that bi-syllabic reduplication adds a meaning of intensification to many such adjectives (e.g., *baliktad* ‘upside down’ ~ *bali~baliktad* ‘all topsy-turvy’). However, they also observe that this construction sometimes exhibits vowel length (i.e., stress) alternations, and always denotes some kind of plurality (although this is not as straightforward as requiring a plural subject). It is perhaps also interesting that these unaccusative adjectives are incompatible with exclamative constructions, as shown previously in (121), considering the similarity of the two reduplication processes.

- b. I-p<in>a-kita niya sa amin [ang **kanya=ng** galíng sa golf].  
 CV-<PFV>CAUS-see 3SG.GEN OBL 1PL.EXCL.OBL NOM 3SG.OBL=LK skill sa golf  
 ‘They<sub>SG</sub> showed us [their<sub>SG</sub> skill at golf].’

In contrast, this alternation is impossible in *ang*-exclamatives. As we see in (138), the pronominal subject of this clause type may only appear in the genitive form following *galíng*, and not in the oblique form preceding *galíng*. This behavior suggests that the subject does not have the formal status of possessor that the genitive pronoun in (137) does. Here, we have no point of comparison with regular declarative adjectives, as they mark their subjects nominative, not genitive, and thus we do not expect genitive inversion to be possible at all, following the discussion in Section 6.2.

(138) NO GENITIVE INVERSION IN *ang*-EXCLAMATIVES

- a. Ang galíng **niya** sa golf!  
*ang* skill 3SG.GEN OBL golf  
 ‘They<sub>SG</sub> are so skilled at golf!’
- b. \*Ang **kanya=ng** galíng sa golf!  
*ang* 3SG.OBL=LK skill OBL golf

The evidence discussed here is summarized in Table 6.4. We see clearly that morphological processes available to *ang*-exclamatives are unavailable in string-identical nominal constructions and vice versa. Additionally, for at least number agreement, we find that the behavior of *ang*-exclamatives aligns with that of regular declarative adjectives. This evidence thus supports the view that the internal structure of *ang*-exclamatives must be different from that of string-identical DPs appearing in clear nominal positions. The former are more clearly adjectival, whereas the latter are more clearly nominal.

Table 6.4: Contrasts between string-identical full DPs and *ang*-exclamatives

|                           | Full DPs | <i>Ang</i> -exclamatives | <i>Ma</i> -adjectives |
|---------------------------|----------|--------------------------|-----------------------|
| Number agreement          | ✗        | ✓                        | ✓                     |
| Bi-syllabic reduplication | ✗        | ✓ (emphatic)             | (✓; softening)        |
| Genitive inversion        | ✓        | ✗                        | —                     |

So far, we have seen some relevant background on adjectives, including how exclamatives alternate with non-exclamatives and which of these exclamatives can and cannot form A'-dependencies. It was suggested that the account for *kay*- and *napaka*-exclamatives mirrors that of RPFV clauses, whereas *ang*-exclamatives have a kind of hybrid structure that prevents the formation of such dependencies. In the next section, I present an analysis of the different exclamative forms that derives the patterns we have observed in relation to A'-dependency formation.

#### 6.5.4 Dependencies with exclamative adjectives

We now turn to the derivation of free dependencies with exclamative adjectives. I begin by discussing concrete structural assumptions about these constructions, highlighting the differences between *kay/napaka*-

exclamatives and *ang*-exclamatives. I then show how these differences interact with the locality requirement on the binding of *pro* to derive the differences we find with respect to  $A'$ -dependency formation.

### 6.5.4.1 Base structure

I assume the structure for exclamatives generally is the same as previously proposed for regular declarative adjectives in Section 3.5 up to *aP*, following the structure proposed by Sabbagh (2005). In this structure, the subject of the adjective is introduced in Spec-*aP*, where I propose that it receives genitive Case from  $a^0$ .<sup>52</sup> An example and corresponding *aP* structure are shown in (139).

- (139) a. {*Ang/Kay/Napaka*}-*galíng* ni lola sa golf!  
*ang kay* very- skill GEN.P grandma OBL golf  
 ‘How good grandma is at golf!’ / ‘Grandma is {so/very} good at golf!’

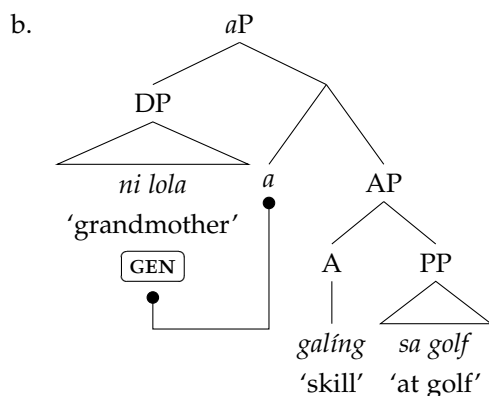

In a declarative adjectival clause, we would typically find the adjective marked with the adjectival prefix *ma-*. I assume this prefix is the joint spell-out of  $\text{Agr}^0$  and  $a^0$ . This accounts for the presence of *ang*-marking on subjects of *ma*-marked adjectives, illustrated by the alternation in (140), as well as the adjectivalizing properties of *ma-*, as demonstrated in (141) showing this prefix attaching to concrete nouns.

(140) *Ma-* CORRELATES WITH NOMINATIVE ASSIGNMENT

- a. **Ma**-*galíng* **si** lola sa golf.  
 ADJ-skill NOM.P grandma OBL golf  
 ‘Grandma is skilled at golf.’
- b. **Napaka**-*galíng* **ni** lola sa golf.  
 very-skill GEN.P grandma OBL golf  
 ‘Grandma is very skilled at golf.’

<sup>52</sup>It is also necessary to adopt *aP* instead of a perhaps more conventional PredP projection due to the particular licensing properties I assume for  $\text{Pred}^0$  in Section 5.2, particularly that it assigns nominative Case to its specifier.



(141) ADJECTIVALIZING FUNCTION OF *ma-*

- a. *tao* ‘person’ → *ma-tao* ‘crowded, populous’
- b. *bundok* ‘mountain’ → *ma-bundok* ‘mountainous’
- c. *umbok* ‘lump, bulge’ → *ma-umbok* ‘lumpy’

I take the absence of nominative Case in exclamative constructions to indicate the lack of an AgrP projection. Since I treat *ma-* as the joint spell-out of Agr<sup>0</sup> and *a*<sup>0</sup>, the lack of AgrP also accounts for the absence of this prefix in exclamative constructions. The structure so far (i.e., *aP*, lack of AgrP) is shared between the three exclamative constructions discussed here. However, we will now see differences between *ang*-exclamatives and the other two.

For *ang*-exclamatives, we have seen evidence suggesting the existence of more structure than just *aP*. We saw in Section 6.5.3.3 that various inflectional forms that are possible in regular declarative adjectives (i.e., plural marking and bi-syllabic reduplication) are also found with this type of exclamative. I assume that these are introduced by syntactic heads above *aP*. The precise nature of the projection(s) that host these morphemes is less important than the fact that they are present, so let us take plural marking as representative of adjectival inflection in general and assume that it is introduced by a head Num<sup>0</sup>, which takes *aP* as its complement. In turn, I assume that NumP is selected by D<sup>0</sup>, which spells out *ang*. An example of this construction in (142) with a corresponding tree.

(142) *Ang*-EXCLAMATIVE CLAUSE

- a. *Ang ga~galíng ng mga lola sa golf!*  
*ang* PL-skill GEN PL grandmothers OBL golf  
 ‘The grandmothers are so skilled at golf!’

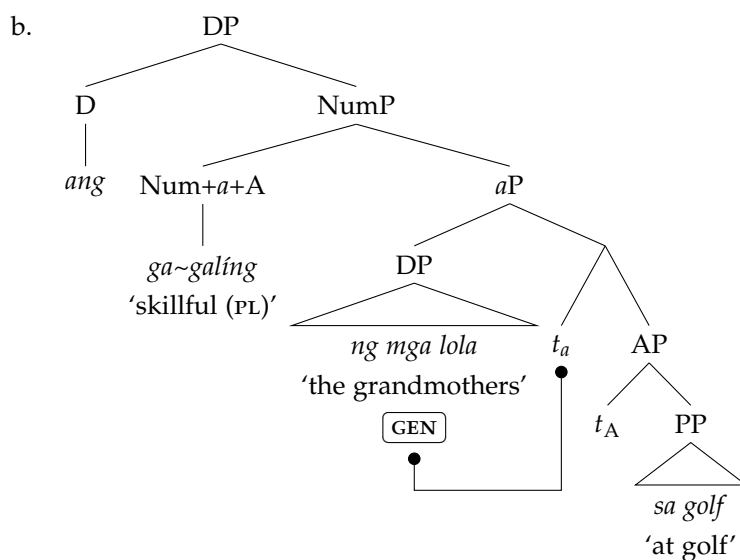

In contrast, evidence suggests that *kay-* and *napaka-*exclamatives do not contain the inflectional structure found in declarative adjectives and *ang*-exclamatives. For example, (143) shows that plural

marking is impossible with these constructions, even with the same adjectival stem and a plural subject.<sup>53</sup> I thus propose that these exclamatives involve *aP* directly selected by a syntactic head *Excl*<sup>0</sup> which spells out *kay* and *napaka-*, as (144) illustrates.<sup>54</sup>

(143) NO PLURAL MARKING FOR *kay/napaka*-EXCLAMATIVES

{Kay/Napaka-} (\*ga~)galíng ng mga lola sa golf!

*kay* very- PL-skill GEN PL grandmothers OBL golf

'How skilled the grandmothers are at golf!' / 'The grandmothers are very skilled at golf!'

(cf. 142a)

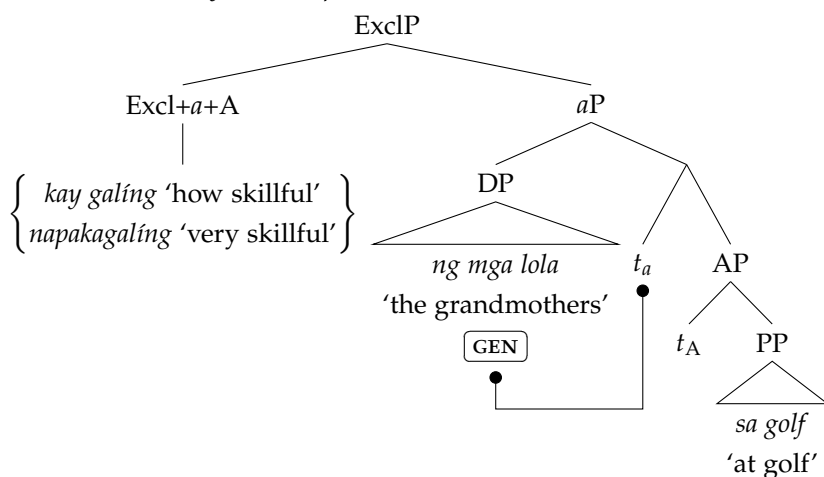
(144) STRUCTURE FOR *kay-* AND *napaka-*EXCLAMATIVES

As with RPFV clauses, I assume that (142b) and (144) show the upper limits of structure for the respective exclamative constructions, and that the impossibility of a number of operations involving the left periphery (i.e., negation, focus fronting, genitive inversion) suggests the absence of the relevant projections. With these structures, we can now consider what happens when we attempt to form *A'*-dependencies.

6.5.4.2 Derivation by *pro*

Recall that dependencies with *ang*-exclamatives are ungrammatical, while those with *kay/napaka*-exclamatives are well-formed, as exemplified in (145). I propose, as with previous constructions, that this difference in behavior that we see boils down to differences in locality between *pro* and the  $\lambda$ -operator. The relevant structures with are shown in (146-147). In both, *pro* is introduced in *Spec-aP*, and a  $\lambda$ -operator is introduced once *C*<sup>0</sup> is merged.

<sup>53</sup>Note that Schachter and Otnes (1972, pp.232–3) indicate that such pluralized forms are possible, at least for *napaka*-exclamatives. However, my consultants judge these examples as ill-formed.

<sup>54</sup>This analysis admittedly leaves unaccounted a number of finer details about the behavior of adjectives that lie outside the scope of this thesis. For example, at least *napaka-* appears to not have the same adjectivalizing capabilities as *ma-*. Thus, while the forms in (141) involving concrete nouns are possible, forms like *napaka-bundok* (intended 'very mountainous'), *napaka-tao* (intended 'very crowded/populous'), and *napaka-umbok* (intended 'very lumpy') are either ungrammatical, marginal, or have a shifted meaning (see also Schachter and Otnes 1972, p.198). Interestingly, in some of these concrete noun cases, *napaka-* and *ma-* can marginally co-occur. For example, from *ma-balahibo* 'furry, hairy', *napaka-ma-balahibo* 'very furry, very hairy' seems to be possible to some extent. Further exploration of these adjective-specific patterns is left for future research.

- (145) T<in>alo ako ng babae=ng [*{\*ang/kay/napaka-}*galíng sa golf].  
 <PFV>lose[PV] 1SG.NOM GEN woman=LK *ang kay* very- skill OBL golf  
 ‘The woman [who is {so/very} good at golf] defeated me.’

- (146) RELATIVIZATION WITH *ang*-EXCLAMATIVE

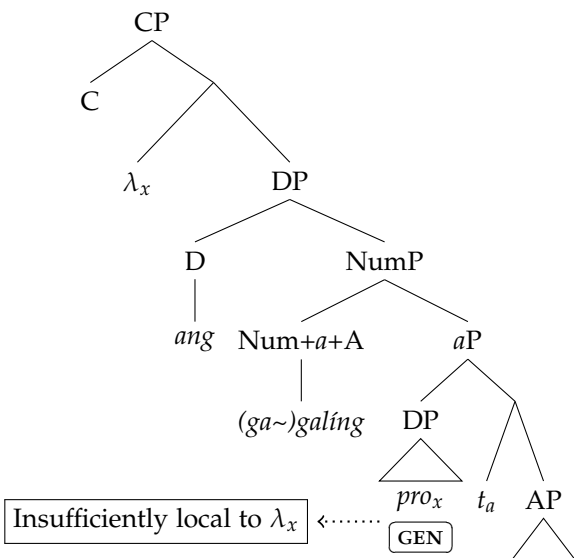

- (147) RELATIVIZATION WITH *kay/napaka*-EXCL.

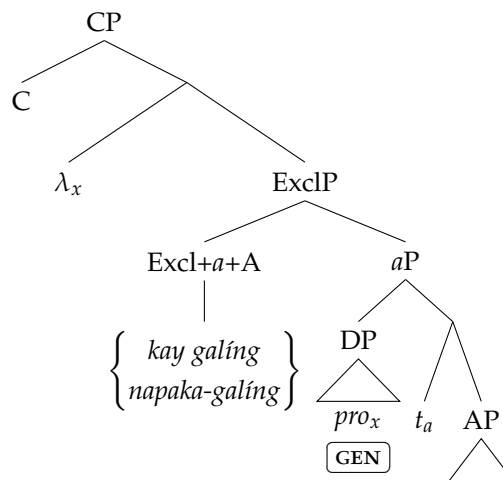

In what way is *pro* sufficiently local to the  $\lambda$  operator in (147), but not in (146)? As we have just seen, *kay*- and *napaka*-exclamatives lack the adjectival inflectional structure (e.g., NumP) that is possible in other adjectival contexts. Furthermore, we have seen previously (Sec. 6.5.1) that the left-peripheral structure of these constructions is similarly reduced (i.e., no NegP, FocP, InvP). In this regard, these exclamatives are an adjectival parallel to the verbal RPFV clauses (Sec. 6.5.2), so I posit that the reduced structure of these exclamatives also allows *pro* to be bound in-situ.

What about the *ang*-exclamatives? We also saw in Section 6.5.1 that these exclamatives show similarly reduced structure as the other two, since they are not compatible with various constructions involving the left periphery of the clause. Despite lacking this left-peripheral structure, however, we have also seen that *ang*-exclamatives *do* have more structure than the other two, which is shown in (146). Crucially, we can distinguish *ang*-exclamatives from both *kay/napaka*-exclamatives as well as RPFV clauses by the fact that the former bears inflectional structure, which the latter cases lack. In this regard, *ang*-exclamatives have more in common with the non-reduced environments that we have considered previously to this section. Thus, I propose that in *ang*-exclamatives, as in other non-reduced environments, the presence of inflectional structure prevents *pro* in the thematic domain (here *aP*) from being bound by the clause edge operator, so *pro* must escape by independent means. As we have seen, however, no mechanism for such an escape (neither pivot movement nor genitive inversion) is available in *ang*-exclamatives, so attempted A'-dependencies with this construction are predicted to be ill-formed.

Having contrasted the differences in structure between *ang*- and *kay/napaka*-exclamatives, we can also contrast the difference in availability of the aforementioned escape mechanisms between *ang*-exclamatives and two other constructions that are in some ways minimally different: declarative adjectives and

true DPs. These environments are like *ang*-exclamatives in having inflectional structure, but are different in having mechanisms for allowing *pro* to escape the thematic domain.

First, we have seen that declarative adjectives may undergo similar inflectional processes as *ang*-exclamatives (Sec. 6.5.3.3), suggesting that they also have at least a NumP projection. Unlike *ang*-exclamatives, however, clauses with declarative adjective predicates also have an AgrP projection, as evidenced by the presence of a pivot argument in examples like (148a). Pivot movement is thus available to facilitate *pro* escaping the thematic domain (*a*P), following a derivation parallel to the voice-agreeing dependencies of Chapter 5, shown in (148c). This correctly predicts that relativization with this kind of construction is possible, as (148b) exemplifies.

(148) RELATIVIZATION WITH DECLARATIVE ADJECTIVAL PREDICATE

- a. Ma-(ga~)galíng pala ang mga babae=ng iyon sa golf.  
 ADJ-PL~skill      MIR    NOM PL    woman=LK    DIST    OBL    golf  
 ‘Those women turned out to be skillful at golf.’      Adjectivally-predicated clause
- b. T<in>alo      ako      ang mga babae=ng [ma-(ga~)galíng pala sa golf].  
 <PFV>lose[PV] 1SG.NOM GEN PL    woman=LK    ADJ-PL~skill      MIR    OBL    golf  
 ‘The women [who turned out to be skillful at golf] defeated me.’  
 Relativized adjectivally-predicated clause

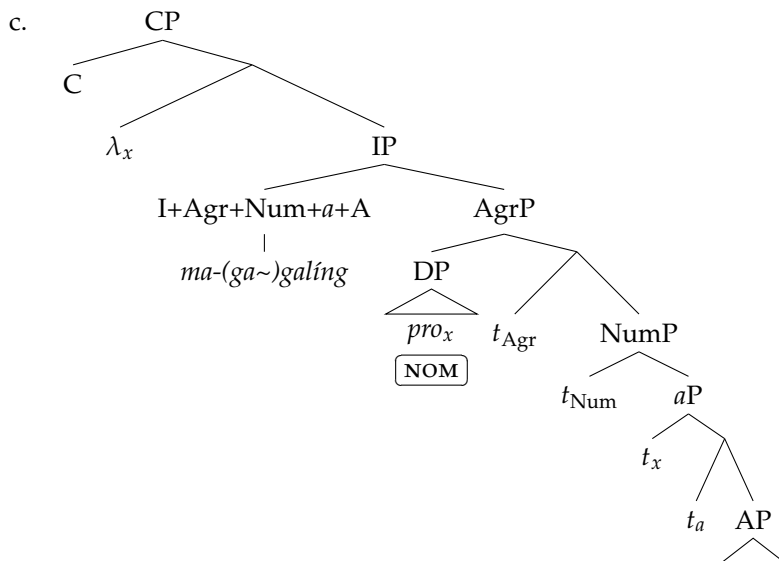

Second, we have true DPs, which are similar to *ang*-exclamatives in possessing a DP layer as well as inflectional structure from the nominal and adjectival domains, respectively. These structures are illustrated in (150-151). Following the proposal so far, such structures require *pro* generated in the thematic domain to escape it. Here again, as with declarative adjectives, true DPs differ from *ang*-exclamatives in having a means for *pro* to escape the thematic domain. In this case, the mechanism is genitive inversion. (149) illustrates again the fact discussed in Section 6.5.3.3 that genitive inversion is impossible in *ang*-exclamatives despite being otherwise string-identical to the parallel true DP. Thus, instances of *pro* within true DPs can undergo genitive inversion to a higher position within the DP to (partially) satisfy

locality with a clause-edge operator and resulting in subextraction dependencies (Sec. 6.4). In contrast, in *ang*-exclamatives, *pro* must stay in-situ and cannot be bound by the operator. As with the above comparison with declarative adjectives, we clearly see the role of movement in satisfying the locality requirement when structure is not reduced.<sup>55</sup>

(149) GENITIVE INVERSION IN *ang*-EXCLAMATIVES VS TRUE DPs

- a. Dapat tular-an ng iba [ang {inyo=ng} sipag {ninyo} sa pag-li~linis].  
 should emulate-LV GEN other NOM 2PL.OBL=LK diligence 2PL.GEN OBL pag-RED~clean  
 ‘Others should emulate [your diligence at cleaning].’ True DP
- b. Ang {\*inyo=ng} sipag {ninyo} sa pag-li~linis!  
*ang* 2PL.OBL=LK diligence 2PL.GEN OBL pag-RED~clean  
 ‘You’re all so diligent at cleaning!’ Ang-exclamative

## (150) RELATIVIZATION FROM TRUE DP

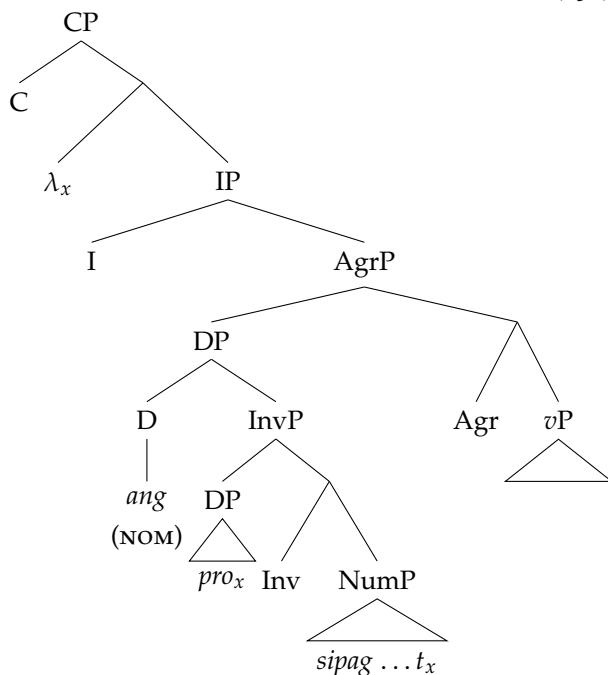
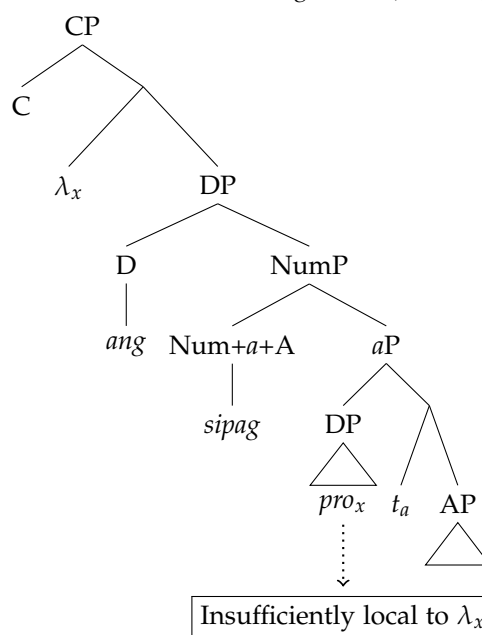
(151) RELATIVIZATION WITH *ang*-EXCL. (from 146)

In this section, I discussed environments where reduced structure allowed in-situ instances of *pro* to be bound by a clause-edge  $\lambda$ -operator, resulting in a greater range of positions being possible A'-dependency targets. These environments were Recent Perfective clauses and *kay/napaka*-exclamatives. We saw that in these constructions, neither of the movement strategies that move *pro* out of the thematic domain (i.e., pivot movement and genitive inversion) were possible. Nevertheless, I argued that *pro* could

<sup>55</sup>We may also ask whether or not  $D^0$  plays a role in the behavior of *ang*-exclamatives, especially given the common assumption that it is a phase head. For example, we might speculate that some kind of phase-(like) boundary is created when a functional head from one extended projection (in the sense of Grimshaw 2000) selects a phrase from a different extended projection. This would be the case for *ang*-exclamatives as proposed:  $D^0$ , which is nominal, selects NumP, which (in this case) is adjectival. Such an explanation might also be applicable elsewhere in the language. For example, preliminary data suggests that subextraction out of gerunds (verbal to nominal) is ill-formed, or at least less well-formed than subextraction involving prototypical nominals. Determining whether such an approach is ultimately viable requires further research.

be bound in-situ due to the reduced structure of these constructions. In particular, I argued that these environments crucially lacked structure in the inflectional domain (e.g., AgrP, IP, NumP, etc.).

In the area of exclamatives, *ang*-exclamatives provided an interesting corner case that supported this idea. I showed that this exclamative construction was like the others in lacking AgrP and higher projections, as well as the aforementioned movement operations of pivot movement and genitive inversion. However, we saw that this exclamative nevertheless had some structure from the inflectional domain (i.e., NumP). I thus suggested that this fact was to blame for the inability of this exclamative construction to form A'-dependencies with *pro*. Under this view, *ang*-exclamatives have neither the kind of reduced structure that allows *pro* to be bound in-situ (in contrast to *kay/napaka*-exclamatives), nor the movement options to allow *pro* to move out of the thematic domain (in contrast to declarative adjectives and true DPs).

## 6.6 Conclusion and discussion

In this chapter, we discussed examples of DP A'-dependencies that go against the descriptive generalization that only nominative-marked positions may be targeted for A'-dependency formation. These constructions, which targeted genitive-marked positions, were divided into three different classes based on behaviors they exhibited. The first two of these showed a number of restrictions such that not all genitive positions were valid targets for A'-dependency formation. The third, in contrast, was more free in this regard. I showed that considering the behavior of these apparently exceptional cases helps us to better understand the mechanisms behind the formation of DP-targeted A'-dependencies previously proposed in Chapter 5.

In essence, the discussion in this chapter has focused on showing the generality of the kind of locality that posited in Chapter 5 to be relevant in the formation of DP A'-dependencies in Tagalog. In that chapter, it was proposed that *pro* needed to escape its base position in the thematic domain in order to be sufficiently local to the operator in the clause edge, and that this escape was facilitated by pivot movement. Here, we saw that the need for *pro* to escape the thematic domain was general, as it could be fulfilled by an alternative movement operation: genitive inversion. This movement was proposed to derive the behavior of the genitive agent and subextraction dependencies, since it allowed pronominal external arguments to escape their base positions in the thematic domain without relying on pivot movement.

Furthermore, I discussed the case of free dependencies, involving Recent Perfective clauses and *kay/napaka*-exclamatives. We saw that these environments were syntactically reduced and independently lacked both pivot movement and genitive inversion. Nevertheless, they allowed the formation of DP-targeted A'-dependencies. I thus argued that in these constructions, reduced structure—specifically reduced inflectional structure—intervening between *pro* and the binder obviated the need for *pro* to escape the thematic domain, allowing it to remain in-situ and still be sufficiently local to the A'-dependency operator. Supporting evidence for this claim came from *ang*-exclamatives, which we saw were similar to RPFV clauses and the other exclamatives in lacking the aforementioned movement operations, but differed in that they *did* exhibit inflectional structure. This construction thus represented an environment where *pro* was insufficiently local to the A'-dependency operator (due to the inflectional structure) yet

“trapped” within the thematic domain (due to restricted movement possibilities), correctly accounting for the incompatibility of this construction with DP-targeted  $A'$ -dependencies.

The overall picture, then, is that whether or not *pro* must escape from the thematic domain depends not on properties of the thematic domain itself (which stays the same between constructions), but on the kind of structure that dominates this domain. This kind of pattern is most naturally captured in terms of locality. However, such a characterization is at odds with the general idea that pronoun-binding approaches should not exhibit the kinds of locality effects argued for here (recall Sections 5.5–5.6). Certainly, there is no straightforward semantic reason to assume that such effects should exist. How, then, might we formalize this generalization? In lieu of a concrete analysis, I offer some speculation here.

Perhaps the most straightforward way we might capture the locality requirement between *pro* and the clause-edge operator is through an Agree relation that is interrupted by a phase boundary that is present in the presence of inflectional structure, but absent otherwise. Under this approach, one major question that must be answered is how this Agree relation differs from the kind that is involved in conventional  $A'$ -movement (ignoring potential distinctions between different types of  $A'$ -movement). That is, are we not simply restating  $A'$ -movement with a different formalization under this approach? Some indication that we are dealing with distinct processes comes from their different locality signatures. As will be discussed in more detail in Chapter 7 (particularly Secs. 7.1 and 7.4.2),  $A'$ -probes can freely access  $vP$ -internal material, while we have seen that such material is only accessible for *pro*-binding in certain cases with reduced structure. Assuming that we are justified in this positing of two distinct types of Agree operations ( $A'$ -probing generally vs “*pro*-binding”), these locality differences might then be accounted for under the general theory of selective opacity proposed by Keine (2016, 2020).

Alternatively, we might reject the locality-based view and entertain the idea that whether or not *pro* moves out of the thematic domain is determined by differences in this domain. Under this alternative, the locality requirement between the operator and *pro* would be illusory; the operator would be able to bind instances of *pro* within the thematic domain, as this is a purely semantic operation. Instead, the movement of *pro* would be necessitated by some property of the thematic domain that is modulated by the type of structure dominating it (i.e., inflectional structure or otherwise). For example, we might imagine that *pro* is incompatible with a value of abstract Case or particular definiteness constraints found within the thematic domain, but only in cases where this domain is dominated by inflectional structure. Although evidence for such alternations exists, it is either weak or does not correspond neatly to the behavior summarized above, so analyses taking this route are less straightforward.

Under the general approach just outlined, an attractive possibility would be to assume that *pro* must appear in an environment that allows a definite interpretation. (152) shows that definite (non-pivot) themes (especially pronouns and personal names) are ungrammatical in regular declarative clauses (152a), but are well-formed in other contexts such as Recent Perfective clauses (152b), among others.<sup>56</sup>

- (152) a. Ta~tawag ako {ng tubero /\*mo /\*sa iyo } mamaya.  
 FUT~call[AV] 1SG.NOM GEN plumber 2SG.GEN OBL 2SG.OBL later  
 ‘I will call {a plumber/\*you} later.’

<sup>56</sup>We have seen this definiteness restriction at various points throughout this thesis, usually framed in slightly different ways.

- b. Kata~tawag ko lang {ng tubero /\*mo /sa iyo } kanina.  
 RPFV~call 1SG.GEN only GEN plumber 2SG.GEN OBL 2SG.OBL earlier  
 ‘I had just called {a plumer/you} a while ago.’

For the data above, the grammaticality of a definite non-pivot theme correlates with the grammaticality of relativizing that position, but to what extent this correlation holds remains to be determined. However, a more serious problem relates to the behavior of external arguments, which may generally receive definite interpretations without restriction. While this freedom correctly accounts for some of the data discussed here, including the genitive agent dependencies as well as the free dependencies with Recent Perfective clauses and *kay/napaka*-exclamatives, subextraction dependencies and *ang*-exclamatives pose problems. For the former, we predict that the DP that hosts *pro* should be able to remain in-situ (i.e., not undergo pivot movement) if it is an external argument, contrary to what was shown in Section 6.4.4. For the latter, we straightforwardly but incorrectly predict that the sole argument of the exclamative should be a valid target for A'-dependency information.

Overall then, we see that a few analytical options are available for formalizing the distribution of *pro* and the nature of its relationship to the clause-edge operator. However, significant details must be ironed out before one of these options can be adopted. I thus leave these issues for future work.



## Chapter 7

# Non-DP Dependencies

This chapter discusses A'-dependencies in Tagalog where the dependency gap corresponds to a non-DP constituent, focusing specifically on *kung* relative clauses (*kung*-RCs) and focus fronting. As discussed in Chapter 4, these constructions can be readily distinguished from their DP-targeting counterparts through their surface structures. *Kung*-RCs, as in (1a), exhibit a complementizer *kung* and an overt *wh*-expression, in contrast to linker RCs like (1b) which have a linker *na/=ng* instead of *kung* and no *wh*-expression. Schematic structures are also provided on the right hand side.

- (1) a. paléngke **kung saán** b<um>ilí ang gúrò ng isdâ  
market if where <AV>buy(PFV) NOM teacher GEN fish  
'market where the teacher bought fish'

*kung*-RC: HEAD *kung* WH V ...

- b. gúrò=**ng** b<um>ilí ng isdâ sa paléngke  
teacher=LK <AV>buy(PFV) GEN fish OBL market  
'teacher who bought fish at the market'

Linker RC: HEAD LK V ...

We also see a difference with respect to focus constructions.<sup>1</sup> Focus fronting, as in (2a) can be most readily distinguished from a pseudocleft like (2b) by the lack of a determiner (commonly *ang*) marking the presuppositional statement. In cases with pronouns or other second position clitics that originate from within the presuppositional statement, we see an additional difference in terms of cliticization position, also shown in (2). With focus fronting, second position is determined with respect to the entire clause, resulting in cliticization to the focus constituent if nothing precedes it. On the other hand with pseudoclefts, second position is determined with respect to only the presuppositional statement, resulting in cliticization to the verb in the example given.<sup>2</sup>

<sup>1</sup>Recall from Ch. 4 that I follow other scholars in assuming that *wh*-questions are a type of focus construction in Tagalog, as the two constructions are structurally parallel.

<sup>2</sup>Note that there is a distinct topicalization construction that can be string-identical to focus fronting. With this kind of topicalization, shown in (i), a topic constituent is fronted to clause-initial position, and no determiner marks the remainder of the clause. Speakers often place a prosodic break after the topic constituent, which I indicate with a comma, but this break may be harder to detect in less careful speech. On the other hand, clitic placement can more consistently identify this construction, as it shows the same signature as pseudoclefts.

- (2) a. Sa palengke {**ninyo**} (\***ang**) b<in>ili {\*ninyo} ang isda.  
 OBL market 2PL.GEN NOM <PFV>buy[PV] NOM fish  
 ‘It was at the market that y’all bought the fish.’ Focus Fronting: FOC CL V ...
- b. Ang isda {\*ninyo} \*(**ang**) b<in>ili {**ninyo**} sa palengke.  
 NOM fish NOM <PFV>buy[PV] 2PL.GEN OBL market  
 ‘What y’all bought at the market was the fish.’ Pseudocleft: FOC *ang* V CL ...

As shown in Chapter 4, the differences just described between the DP-targeting and non-DP-targeting constructions are not merely surface-level, but instead reflect structural differences between these constructions. I thus argued that Tagalog has two distinct sets of strategies for forming A'-dependencies, conditioned on the category of the targeted constituent. We also saw that along with this structural difference, there were also significant differences in terms of the accessibility of dependency targets. In particular, it was shown that non-DP A'-dependencies do not interact with the Tagalog voice system in the same way that DP A'-dependencies prominently do. The existence of these two sets of dependency formation strategies and their differences thus lead to a number of questions that have significant implications for Tagalog syntax. What restricts the application of the DP dependency constructions (i.e., linker RCs and pseudoclefts) to DPs and non-DP dependency constructions (i.e., *kung*-RCs and focus fronting) to non-DPs? How are non-DP dependencies able to circumvent the restriction that is the major feature of the other half of Tagalog A'-dependencies?

These questions have been the underlying focus of this thesis, and in the previous two chapters, I proposed partial answers to them. The main idea, developed in Chapter 5, was that DPs in Tagalog cannot undergo conventional A'-movement because of Case licensing reasons—movement of DPs must always be to positions where Case is assigned. Assuming that focus fronting and *kung*-RCs involve positions in the clausal left periphery that are not assigned abstract Case, we understand why these constructions cannot target DPs. Thus, instead of movement, I proposed that the formation of linker RCs—and consequently of pseudoclefts, which are formed from linker RCs—involves a null pronoun *pro*, which introduces a semantic variable and is bound by an operator that appears at the clause edge. In Chapters 5 and 6, it was shown that the binding of *pro* was subject to a locality requirement that could be satisfied by *pro* undergoing an independently available movement operation (i.e., pivot movement or genitive inversion) out of the thematic domain or if the intervening structure between in-situ *pro* and the operator was significantly reduced. In this way, we derived not only the behavior conforming to the Tagalog pivot-only restriction, but also the apparent exceptions to this restriction.

In this chapter, I present the other half of the picture for Tagalog A'-dependencies. The central claim in this chapter is that A'-dependencies that target non-DPs are formed via conventional A'-movement rather than the *pro*-based mechanism previously developed. Unlike DPs, non-DPs do not require Case licensing, so they may undergo movement to A'-positions, where no Case is assigned. I begin by providing a description of the constructions under discussion, including a number of key properties that I argue are

(i) Sa palengke {\*ninyo} , b<in>ili {**ninyo**} ang isda.  
 OBL market <PFV>buy[PV] 2PL.GEN NOM fish  
 ‘At the market, y’all bought the fish.’

important for any analysis of Tagalog  $A'$ -dependencies to account for. In this description, I also focus in particular on the *kung*-RC, and discuss a number of other constructions that may appear similar, but in fact exhibit different behavior from *kung*-RCs, and thus are excluded from the analysis. I then present a formal analysis for the non-DP  $A'$ -dependencies under discussion here, which makes use of Rizzi's (1997) articulated left periphery proposal.

## 7.1 On the DP/non-DP split

In this section, I discuss a handful of properties exhibited by Tagalog non-DP dependencies that have important implications for the analysis of  $A'$ -dependencies generally in this language. First, we will see that non-DP  $A'$ -dependencies can be formed from non-DPs (primarily oblique-marked PPs) originating from a range of positions with different syntactic heights. Such behavior represents a different locality signature from what we have seen with DP dependencies in Chapters 5–6, and is easily understood under the view advanced here that Tagalog has distinct mechanisms for generating DP and non-DP dependencies. In contrast, I show that this behavior presents a problem for common locality- or phase-based approaches to Tagalog  $A'$ -dependencies that do not distinguish between the DP-targeting and non-DP targeting ones. Second, we will see that the non-DP strategy persists over a number of construction types, even those that allow more freedom in target choice for DP dependencies as we saw with the free genitive dependencies in Section 6.5. I argue that this persistence shows us that the split between DP and non-DP  $A'$ -dependencies in Tagalog is ultimately due to the DP- or non-DP-hood of the dependency target, and not due to some other factor. This conclusion thus supports the view that an intrinsic difference between DPs and non-DPs, such as the need for Case licensing, lie at the heart of the structural split between DP-targeting and non-DP-targeting  $A'$ -dependency constructions.

### 7.1.1 Non-DP dependencies are voice-agnostic

In Chapter 4, we saw that one way in which non-DP  $A'$ -dependencies are more free than those of DPs is the fact that they are not restricted by the voice system. For example, the locative argument *sa lamesa* 'on the table' of *lagay* 'put' in (3) may be focused or relativized in any voice that does not applicativize it, as shown by the AV and CV forms in (4-5).

(3) LOCATIVE ARGUMENT OF *lagay* 'PUT'

- a. Nag-lagay ang kusinero ng kaldero sa lamesa.  
AV.PFV-put NOM cook GEN pot OBL table  
 'The cook put a pot on the table.'
- b. I-ni-lagay ng kusinero ang kaldero sa lamesa.  
CV-PFV-put GEN cook NOM pot OBL table  
 'The cook put the pot on the table.'

(4) LOCATIVE *kung*-RC

- a. Hindi ma-tibay ang lamesa kung saan [nag-lagay ang kusinero ng kaldero].  
 NEG ADJ-sturdy NOM table if where AV.PFV-put NOM cook GEN pot  
 ‘The table where [the cook put a pot] is not sturdy.’
- b. Hindi ma-tibay ang lamesa kung saan [i-ni-lagay ng kusinero ang kaldero].  
 NEG ADJ-sturdy NOM table if where CV-PFV-put GEN cook NOM pot  
 ‘The table where [the cook put the pot] is not sturdy.’

## (5) LOCATIVE FOCUS FRONTING

- a. {Saan /Sa lamesa} nag-lagay ang kusinero ng kaldero.  
 where OBL table AV.PFV-put NOM cook GEN pot  
 ‘Where did the cook put a pot?’  
 ‘It was on the table that the cook put a pot.’
- b. {Saan /Sa lamesa} i-ni-lagay ng kusinero ang kaldero.  
 where OBL table CV-PFV-put GEN cook NOM pot  
 ‘Where did the cook put the pot?’  
 ‘It was on the table that the cook put the pot.’

The fact that the low locative argument in the preceding examples can be focused or relativized poses a general problem for locality- or phase-based approaches to the Tagalog pivot-only extraction restriction or to other similar phenomena under the umbrella of syntactic ergativity (e.g., Aldridge 2004a; Rackowski and Richards 2005; Coon et al. 2014). Taking the proposals by Aldridge (2004a) and Rackowski and Richards (2005) specifically, they assume that the nominative-marked pivot occupies the Spec-*v*P phase edge position, either through movement (for internal arguments) or by base generation (for external arguments). The pivot argument being in this position then blocks the extraction of lower XPs for one of two reasons: either the pivot occupies the escape hatch of the phase, thus blocking lower XPs from moving out (Aldridge 2004a); or the pivot is the most local goal for a relevant *A'*-probe, which is relativized to a [D] feature Rackowski and Richards (2005). The data in (4-5) is generally problematic for such approaches because, as sketched in (6), these represent cases where an internal argument (PP) is somehow accessible to the *A'*-probe (*C*<sup>0</sup>) despite its presumably phase-internal position and/or the intervening nominative pivot (*DP*<sub>1</sub>).<sup>3</sup>

<sup>3</sup>Coon et al. (2014) deal with Mayan languages and propose slightly different theoretical machinery to derive the behaviors in the languages considered. However, they also make the prediction that phase-internal material should not be accessible to an *A'*-movement without independently escaping the phase.

## (6) LOCALITY-/PHASE-BASED APPROACHES TO TAGALOG EXTRACTION

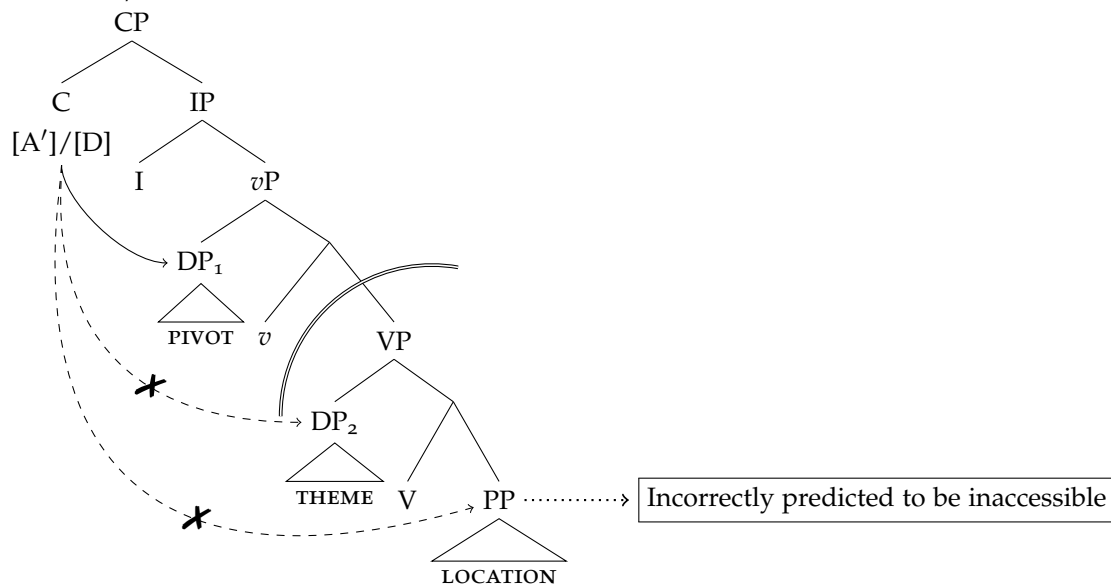

Note that non-pivot DP arguments (particularly themes) are generally inaccessible. This inaccessibility is correctly accounted for by locality- and phase-based approaches, but in doing so, these approaches also exclude a few potential approaches to account for the extraction of non-DPs. For a phase-based approach, the phase cannot be weakened or eliminated to allow non-DP extraction, as it would predict that other arguments internal to the phase should also be accessible. For a locality-based approach, the problem is similar if slightly more subtle. Assuming an approach that derives locality effects through an additional [ $\mu$ D] feature on an  $A'$ -probe, we might attempt to derive the accessibility of the non-DP as an “unbundling” of this [ $\mu$ D] feature and the relevant  $A'$ -feature presumably on the probe. Without the [ $\mu$ D] feature, the pivot no longer acts as an intervener if it does not bear the correct  $A'$ -feature, however, we encounter the same problem as the phase-based approach. That is, while we would predict non-DPs to be accessible, we would also predict non-pivot DPs to be accessible as well, contrary to evidence.

The crux of the problem described above is that the mechanisms that restrict accessibility undergenerate (with respect to non-DP dependencies) when applied, but overgenerate (with respect to non-pivot dependencies) when loosened. This situation suggests that we must rely on a different syntactic property to derive the asymmetry in behavior between DPs and non-DPs. This observation supports the main objective of this thesis, which has been to advance the idea, based on the previously discussed structural differences between  $A'$ -dependencies of DPs and non-DPs, that Tagalog possesses fundamentally different strategies for forming  $A'$ -dependencies conditioned on the syntactic category (DP or not) of the dependency target.<sup>4</sup> The previous chapters have argued that DP dependency formation does not proceed through conventional mechanisms of  $A'$ -movement, but instead through a null pronoun *pro*, which has

<sup>4</sup>Another approach that does not rely on locality is proposed by Erlewine (2018) for another Austronesian language, Toba Batak. On this analysis, a property particular to non-pivots in this language is to blame for their non-extractability: that they must be licensed by adjacency (Levin 2015) to the verb. This in turn predicts that Toba Batak should behave like Tagalog in allowing  $A'$ -dependencies to target structurally low non-DPs, which appears to be correct (see Erlewine 2018, ex.21).

Although they are formally distinct, there are broad conceptual similarities between the Case licensing system proposed here and the idea of licensing by adjacency (especially with regards to their effects on movement), such that unifying the two notions may be possible. That said, there does not seem to be strong evidence for non-pivots requiring licensing by adjacency in Tagalog, so application of this analysis to Tagalog seems unlikely.

particular licensing requirements. Here, I propose that non-DPs *do* undergo conventional A'-movement.

### 7.1.2 Non-DP dependencies are structure-agnostic

In addition to their voice-agnostic behavior just shown, there is another way in which non-DP A'-dependencies are freer than DP dependencies. We have previously seen examples involving a low PP argument in (4-5), but non-DPs originating from a diverse range of syntactic positions can be focused and relativized using the same construction. The examples below show focus and relativization of causees (7), locative adjuncts (8), and sources/causes of states of emotion (9), which are all marked oblique when not the pivot of the clause.<sup>5</sup>

#### (7) CAUSEE FOCUS AND RELATIVE CLAUSE

- a. I-p<in>a-sulat niya sa bago=ng mag-aarál ang sagot sa pisara.  
 CV-<PFV>CAUS-write 3SG.GEN OBL new=LK student NOM answer OBL blackboard  
 'They<sub>SG</sub> had the new student write the answer on the blackboard.' Baseline
- b. {Sa bago=ng mag-aarál/Kanino } niya i-p<in>a-sulat ang sagot sa pisara.  
 OBL new=LK student who.OBL 3SG.GEN CV-<PFV>CAUS-write NOM answer OBL blackboard  
 'It's the new student who they<sub>SG</sub> had write the answer on the blackboard.'  
 'Who did they<sub>SG</sub> have write the answer on the blackboard?'
- c. <sup>?</sup>Bago=ng mag-aarál ang bata [kung kanino niya i-p<in>a-sulat ang sagot sa  
 new=LK student NOM child if who.OBL 3SG.GEN CV-<PFV>CAUS-write NOM answer OBL  
 pisara].  
 blackboard  
 'The child who they<sub>SG</sub> had write the answer on the blackboard is a new student.'<sup>6</sup>

#### (8) LOCATIVE ADJUNCT FOCUS AND RELATIVE CLAUSE

- a. {Sa pisara /Saan } niya i-p<in>a-sulat sa bago=ng mag-aarál ang sagot.  
 OBL blackboard where 3SG.GEN CV-<PFV>CAUS-write OBL new=LK student NOM answer  
 'It's on the blackboard that they<sub>SG</sub> had the new student write the answer.'  
 'Where did they<sub>SG</sub> have the new student write the answer?' cf. Baseline (7a)
- b. Li~linis-in mamaya ang pisara [kung saan niya i-p<in>a-sulat sa bago=ng  
 FUT~clean-PV later NOM blackboard if where 3SG.GEN CV-<PFV>CAUS-write OBL new=LK  
 mag-aarál ang sagot].  
 student NOM answer  
 'The blackboard where they<sub>SG</sub> made the new student write the answer will be cleaned later.'

<sup>5</sup>These types of arguments can be promoted to pivot, in which case, they form DP dependencies (i.e., linker RCs and pseudo-clefts); see chap. 4. In (7-9), however, focus fronting and *kung*-RCs are involved. Recalling (1-2), we see cliticization to the focus phrase and absence of *ang*-marking on the presuppositional statement in (7b), (8a), (9b) and the signature *kung+wh* sequence in (7c), (8b), (9c).

<sup>6</sup>Examples like (7c) that involve a *kung*-RC of an individual (here a causee) may have slightly reduced acceptability overall for some speakers, however the data does not appear clear-cut.



So far, we have seen that non-DP dependencies can be said to be freer than their DP counterparts. They ignore the Tagalog voice system (modulo cases where the non-DP has been “promoted” to a DP pivot through the voice system), and they freely apply to anything that is a non-DP. The generality of application to non-DPs is further supported by the persistence of non-DP dependencies across various environments, which I turn to next.

### 7.1.3 Persistence of the non-DP form

A natural hunch one may have when presented with the behavior of non-DP A'-dependencies is that these constructions are different from DP dependencies because they represent a kind of circumvention of the pivot-only restriction. In the previous subsection, I presented some evidence arguing against this view by showing that accessibility for A'-dependencies generalizes across non-DPs in various structural configurations. Here, I present additional evidence against this view, showing that the non-DP dependency forms persist even in environments where extraction is freer.

Under the view that non-DP dependencies differ in structure because they somehow allow circumvention of the voice system and the pivot-only restriction, we might expect to find that in environments where this restriction is loosened, the distinction between DP and non-DP A'-dependencies collapses. In Section 6.5 we saw one such environment with the Recent Perfective (RPFV) form. Recall that in an RPFV clause as in (11), the verb bears no voice morphology and no argument is marked nominative.

- (11) Kala~lagay lang ng nars ng gamot sa lamesa.  
 RPFV~put only GEN nurse GEN medicine OBL table  
 ‘The nurse has just put (some) medicine on the table.’

Despite these details, we saw that A'-dependencies are not only possible with RPFV clauses, they can furthermore freely target any DP argument within the clause, as shown with relativization in (12). Note that in both examples shown are linker relative clauses, as expected from the relevant dependency targets being DPs. As we see in (13), *kung* relative clauses targeting DPs in RPFV clauses are ungrammatical.

- (12) LINKER RELATIVE CLAUSES WITH RECENT PERFECTIVE
- a. Ma-hilig sa halaman ang nars na [kala~lagay lang ng gamot sa lamesa].  
 ADJ-liking OBL plant NOM nurse LK RPFV~put only GEN medicine OBL table  
 ‘The nurse [who has just put (some) medicine on the table] is fond of plants.’ Agent RC
- b. Kulay puti ang gamot na [kala~lagay lang ng nars sa lamesa].  
 color white NOM medicine LK RPFV~put only GEN nurse OBL table  
 ‘The medicine [that the nurse has just put on the table] is white.’ Theme RC



(13) UNGRAMMATICAL *kung* RELATIVE CLAUSES WITH RECENT PERFECTIVE

- a. \*Ma-hilig sa halaman ang nars kung {sino /nino } (ang) [kala~lagay lang ng  
 ADJ-liking OBL plant NOM nurse if who.NOM who.GEN NOM RPFV~put only GEN  
 gamot sa lamesa].  
 medicine OBL table

Intended: 'The nurse [who has just put (some) medicine on the table] is fond of plants.'

(cf. 12a)

- b. \*Kulay puti ang gamot kung ano (ang) [kala~lagay lang ng nars sa lamesa].  
 color white NOM medicine if what NOM RPFV~put only GEN nurse OBL table

Intended: 'The medicine [that the nurse has just put on the table] is white.'

(cf. 12b)

On the other hand, the behavior of non-DPs is the reverse of that of DPs. In contrast to its agent and theme arguments, the locative argument of *lagay* 'put' must be relativized with a *kung*-RC, even in an RPFV clause, as we see in (14a). The linker RC strategy remains unavailable, as (14b) shows. Parallel behavior can be seen with other kinds of oblique phrases, such as causees, as shown in (15).

(14) LOCATIVE ARGUMENT IN RPFV RELATIVIZES WITH *kung*-RC

- a. Itim ang lamesa [kung saan kala~lagay lang ng nars ng gamot].  
 black NOM table if where RPFV~put only GEN nurse GEN medicine

'The table [where the nurse has just put (some) medicine] is black.'

✓*Kung*-RC

- b. \*Itim ang lamesa[=ng kala~lagay lang ng nars ng gamot].  
 black NOM table =LK RPFV~put only GEN nurse GEN medicine

Intended: 'The table [where the nurse has just put (some) medicine] is black.'

\*Linker RC

(15) CAUSEE IN RPFV RELATIVIZES WITH *kung*-RC

- a. Kaka-pa-bili lang nila sa amin ng bago=ng uniporme.  
 RPFV-CAUS-buy only 3PL.GEN OBL 1PL.EXCL.OBL GEN new=LK uniform

'They have just had us buy new uniforms.'

Baseline

- b. Na-irita ang mga empleyado [kung kanino kaka-pa-bili lang nila ng bago=ng  
 PFV-irritate NOM PL employee if who.OBL RPFV-CAUS-buy only 3PL.GEN GEN new=LK  
 uniporme].  
 uniform

'The employees [who they have just had buy new uniforms] got irritated.'

✓*Kung*-RC

- c. \*Na-irita ang mga empleyado[=ng kaka-pa-bili lang nila ng bago=ng uniporme].  
 PFV-irritate NOM PL employee =LK RPFV-CAUS-buy only 3PL.GEN GEN new=LK uniform

Intended: 'The employees [who they have just had buy new uniforms] got irritated.'

\*Linker RC

The picture is similar for focus constructions, but with a slight complication. DPs are focused with pseudoclefts, as in (16), which require a determiner marking the presuppositional content.

## (16) PSEUDOCLEFTS WITH RECENT PERFECTIVE

- a. {Ang nars /Sino} \*(ang) [kala~lagay lang ng gamot sa lamesa].  
 NOM nurse who NOM RPFV~put only GEN medicine OBL table  
 'The one who has just put (some) medicine on the table is the nurse.'  
 'Who has just put (some) medicine on the table?' Agent focus
- b. {Ang gamot /Ano} \*(ang) [kala~lagay lang ng nars sa lamesa].  
 NOM medicine what NOM RPFV~put only GEN nurse OBL table  
 'What the nurse has just put on the table is the medicine.'  
 'What has the nurse just put on the table?' Theme focus

The status of non-DP focus is a little more unclear. Focus fronting of non-DPs in RPFV clauses shows variable acceptability among speakers, usually being degraded if at all acceptable, as shown in (17). Note that speakers tend to judge these examples more favorably if the second position clitics, of which *lang* 'only' is one, appear post-verbally instead of post-focus constituent. This is unusual given previous discussion of focus fronting in Chapter 4, and will be revisited in Section 7.3.6.

## (17) ATTEMPTED FOCUS FRONTING IN RECENT PERFECTIVE

- a. {Sa lamesa/Saan } {\*lang} kala~lagay {<sup>?</sup>lang} ng nars ng gamot.  
 OBL table where only RPFV~put only GEN nurse GEN medicine  
 Intended: 'It's on the table that the nurse just put (some) medicine.'  
 Intended: 'Where did the nurse just put (some) medicine?' Location/Goal
- b. {Sa amin /Kanino } {\*lang} kaka-pa-bili {<sup>?</sup>lang} nila ng bago=ng uniporme.  
 OBL 1PL.EXCL.OBL who.OBL only RPFV-CAUS-buy only 3PL.GEN GEN new=LK uniform  
 Intended: 'It's us who they have just had buy new uniforms.'  
 Intended: 'Who have they just had buy new uniforms?' Causee
- c. {Kay Pedro/Kanino } {\*lang} kabi~bigay {<sup>?</sup>lang} ni Juan ng pera.  
 OBL.P Pedro who.OBL only RPFV~give only GEN.P Juan GEN money  
 Intended: 'It's to Pedro that Juan has just given money.'  
 Intended: 'To whom has Pedro just given money?' Goal/Recipient

An example of ungrammatical focus fronting of another type of non-DP is given in (18). The temporal adverb *kanina* 'earlier' is grammatical post-verbally, but nevertheless cannot undergo focus fronting. Note that this adverb *can* front in a non-RPFV clause, as shown in (18c).

## (18) ATTEMPTED FOCUS FRONTING OF A TEMPORAL ADJUNCT IN RECENT PERFECTIVE

- a. Kaka-inom lang ng pasyente ng gamot kanina.  
 RPFV~drink only GEN patient GEN medicine earlier  
 'The patient had just taken some medicine earlier.' Baseline

- b. \*Kanina {lang} kaka-inom {lang} ng pasyente ng gamot.  
 earlier only RPFV-drink only GEN patient GEN medicine  
 Intended: 'It was earlier that patient had just taken some medicine.' \*Focus Fronting
- c. Kanina lang <in>inom ng pasyente ang gamot.  
 earlier only <PFV>drink[PV] GEN patient NOM medicine  
 'It was just earlier that the patient took some medicine.' ✓Focus Fronting in non-RPFV

Given the degraded nature of focus fronting with RPFV clauses, it is interesting to note, then, that pseudoclefts targeting non-DP positions in RPFV clauses are categorically judged to be ungrammatical. The examples in (19) show this with questions. At the very least, then, we see that non-DPs in RPFV clauses show focus behavior that can be seen as consistent with the structural split in A'-dependencies described so far. That is, non-DPs (even those in RPFV clauses) cannot be targeted with the DP focus strategy (i.e., pseudoclefting).<sup>8</sup>

(19) PSEUDOCLEFTS CANNOT TARGET NON-DPs IN RECENT PERFECTIVE

- a. \*{Ano/Saan } ang kala~lagay lang ng nars ng gamot?  
 what where NOM RPFV-put only GEN nurse GEN medicine  
 Intended: 'Where has the nurse just put (some) medicine?' Location/Goal (cf. 17a)
- b. \*{Sino /Kanino } ang kaka-pa-bili lang nila ng bago=ng uniporme?  
 who.NOM who.OBL only RPFV-CAUS-buy only 3PL.GEN GEN new=LK uniform  
 Intended: 'Who have they just had buy new uniforms?' Causee (cf. 17b)
- c. \*{Sino /Kanino } ang kabi~bigay lang ni Juan ng pera?  
 who.NOM who.OBL only RPFV~give only GEN.P Juan GEN money  
 Intended: 'To whom has Pedro just given money?' Goal/Recipient (cf. 17c)

We thus see that even in environments like Recent Perfective where the pivot-only restriction has been relaxed, the distinction between DP and non-DP dependencies remains robust. DP A'-dependencies take the form of linker relative clauses and pseudoclefts, while non-DP dependencies take the form of *kung* relative clauses and (to some degree) focus fronting. This shows us that the dichotomy of A'-dependencies is likely not rooted in structural factors, but is instead intrinsic to the DP-hood or non-DP-hood of the constituent targeted by the dependency.

In this thesis, I capture this dichotomy by proposing stricter interpretative requirements for Case, expanding on a proposal by Béjar and Massam (1999), which results in restricted A'-movement possibilities for those XPs that are standardly assumed to require licensing through Case, namely DPs. This proposal was the main focus of the previous chapters. The other side of the coin is that XPs not needing Case are predicted to be unaffected by the Case licensing system, and therefore *can* undergo standard A'-movement.

<sup>8</sup>It is worth noting that the behavior of A'-dependencies targeting non-DPs in RPFV clauses has been discussed previously in the literature. In particular, McGinn (1988) and Schachter (1996, citing McGinn) present evidence that pseudoclefts and linker relative clauses, respectively, can target non-DPs in RPFV clauses. In other words, they claim that examples like those in (19) as well as (14b) and (15c) are grammatical. However, I have not been able to reproduce such data with my consultants, which is also what Kroeger (1993, p.54) reports.

This is thus the claim I make for how non-DP  $A'$ -dependencies are formed. In the rest of this chapter, I lay out my proposal for non-DP dependency formation, couched in Rizzi's (1997) articulated left periphery proposal, and discuss how it does or does not interact with DP dependency formation.

## 7.2 Preliminaries to the articulated left periphery

Here, I introduce the framework under which I capture the idea stated in the previous section that non-DP  $A'$ -dependencies are in some sense more cross-linguistically typical than DP  $A'$ -dependencies in Tagalog. I adopt the articulated left periphery approach of Rizzi (1997), whereby the CP projection of a clause is expanded into a number of sub-projections, each with an associated clause-level function or operation (i.e., mood, topic, relativization, finiteness, etc.). We will see that a natural and welcome consequence of this analysis is that it interacts well with the analysis of Tagalog DP  $A'$ -dependencies developed in this thesis to account for why these constructions are structurally distinct from their non-DP-targeting counterparts, as was discussed in Section 5.2. We will also see that adopting the articulated left periphery approach allows us to account for a more general range of construction types and their interactions with each other.

### 7.2.1 Rizzi (1997)

To begin, I first summarize the main points of the articulated left periphery analysis. Drawing on a number of Romance and Germanic languages, Rizzi (1997) proposes an account of the fine structure of the left periphery of a clause, mainly relying on evidence from word order restrictions or patterns that arise when multiple types of left-peripheral elements co-occur. Within this analysis, Rizzi proposes the general structure in (20), which will serve as our starting point for discussion.

- (20) ARTICULATED LEFT PERIPHERY FOR ITALIAN (Rizzi 1997)  
 ForceP > TopP\* > FocP > TopP\* > FinP

A clause minimally bears ForceP and FinP. Force<sup>0</sup> specifies the type or mood of the clause (e.g., declarative, interrogative, etc.), exposing this information to any selecting heads. Fin<sup>0</sup> on the other hand specifies the finiteness properties of the lower IP. In addition to these two projections, we also have a topic/focus field in between these two projections. The exact structure of this field is subject to cross-linguistic variation. Rizzi proposes that, in Italian, this field consists of recursive TopP projections and one FocP projection, which host topic and focus constituents, respectively, in their specifiers. Interrogative pronouns compete with (other types of) focused phrases for the Spec-FocP position, while relative pronouns are proposed to occupy Spec-ForceP.

The structure that Rizzi proposes accounts for a number of relative ordering and co-occurrence restrictions in Italian, such as the one shown in (21). Here, we see that relative pronouns must precede topics in Italian, a fact that is accounted for by the hierarchical ordering of ForceP and TopP.

## (21) RELATIVE PRONOUN PRECEDES TOPIC IN ITALIAN

Un uomo {*a cui*}, il premio Nobel, {*\*a cui*} lo daranno senz'altro  
 a man to whom the prize Nobel it they.will.give undoubtedly

'A man to whom, the Nobel Prize, they will give it undoubtedly.' Rel > Top (Rizzi 1997, ex.42)

Similar patterns are attested in the clausal left periphery of Tagalog. These involve the now familiar focus fronting and *kung*-RC constructions, as well as a number of others. In particular, a few other constructions bear a similar *kung+wh* signature to *kung*-RCs. In the next subsection, I introduce these constructions, as well as other constructions that exhibit *kung*. The goal will be to clearly delineate between these constructions that may closely resemble each other, as well as to argue that *kung* spells out Force<sup>0</sup>, and to discuss an apparent puzzle in its position that can in fact be understood rather straightforwardly within the current framework.

7.2.2 On *kung* and *kung+wh*

The particle *kung* that features prominently in *kung*-RCs also has a number of other complementizer-like uses (Hsieh and Nie 2018), and in this regard is parallel to the linker morpheme *na/=ng* (see Schachter and Otnes 1972). Most straightforwardly, *kung* introduces conditional antecedents, as shown in (22), and embedded polar questions, as in (23). Perhaps it is because of this distribution that the particle is intuitively translated by native speakers to English as *if*.

(22) [**Kung** k<um>a~káin ka], ka~káin din akó.  
 if AV.IMPF~eat 2SG.NOM FUT~eat[AV] also 1SG.NOM

'If you're eating, I'll eat as well.'

Conditional antecedent

(23) T<in>anóng ng gúro [**kung** may lápís (ba) ang estudyánte].  
 <PFV>ask[PV] GEN teacher if EXIS pencil Q NOM student

'The teacher asked if the student had a pencil.'

Embedded polar question

In other contexts, we also find the *kung+wh* sequence familiar from *kung*-RCs. First, we have embedded *wh*-questions, which appear in a typical position for complement clauses in Tagalog, and consistently take the form of the corresponding matrix question introduced by *kung*. Embedded DP questions are pseudoclefts marked with *kung*, while embedded non-DP questions are focus fronting constructions marked with *kung*. Consequently, the structural differences between these two focus constructions that are found in matrix environments are preserved in the embedded environment as well (recall Section 4.2). For example, nominative marking on the presuppositional statement is obligatory for the embedded DP question (24a), but ungrammatical for the embedded non-DP question (24b).

(24) EMBEDDED *wh*-QUESTIONS

a. T<in>anóng ng gúro [**kung síno** \*(ang) d<um>atíng].  
 <PFV>ask[PV] GEN teacher if who NOM <AV>arrive(PFV)

'The teacher asked who arrived.'

DP target → Pseudocleft (*ang*)

b. T<in>anóng ng gúrò [**kung saán** (\*ang) p<um>untá ang estudyánte].

<PFV>ask[PV] GEN teacher if where NOM <AV>go(PFV) NOM student

‘The teacher asked where the student went.’ Non-DP target → Focus fronting (no *ang*)

Second, we have constructions that I will refer to as **FREE RELATIVES**. These are semantically similar to English *wh-ever* free relatives, and have a surface structure parallel to what we have seen with Tagalog embedded *wh*-questions in (24). For example, free relatives mirror the distribution of nominative marking on the presuppositional statement, highlighted with single underlining in (25). These free relatives can appear post-verbally in argument-like positions, as shown in (25), but are crucially different from *kung*-RCs as they do not exhibit a clear nominal head. Furthermore, they cannot be marked with a determiner even in a position that would typically be marked with a determiner, as shown by the ungrammaticality of *ang* (wavy underline) before *kung* in (25a); compare this with (26).<sup>9</sup>

(25) **FREE RELATIVES**

a. Ka~kausáp-in ni Tina [(\*ang) kung síno \*(ang) d<um>atíng].

FUT~speak.with-PV GEN.P Tina NOM if who NOM <AV>arrive(PFV)

‘Tina will speak to whoever arrived.’ DP target → Pseudocleft (*ang*)

b. A~alís si Jojo [**kung kailán** (\*ang) a~alís si Kiko].

FUT~leave[AV] NOM.P Jojo if when NOM FUT~leave[AV] NOM.P Kiko

‘Jojo will leave whenever Kiko leaves.’ Non-DP target → Focus fronting (no *ang*)

(26) Ka~kausáp-in ni Tina \*(ang) manunulat.

FUT~speak.with-PV GEN.P Tina NOM author

‘Tina will speak to the author.’ Marking on a typical DP argument (*cf.* 25a)

Free relatives may also appear in a clause-initial (topic-like) position. In this case, they are very naturally followed by a focus construction where the focus constituent shares a referent with the free relative. Examples are given in (27). For unclear reasons that are likely semantic in nature, free relatives appear in this clause-initial position much more freely than in post-verbal argument or adjunct positions, where they are sometimes ill-formed. For example, compare (27a) with the free relative appearing clause-initially and the counterpart sentence (28) with a post-verbal free relative.

(27) **CLAUSE-INITIAL FREE RELATIVES**

a. [**Kung sino** ang ma-u~una]<sub>i</sub>, siya<sub>i</sub> ang maka~ka-kuha ng premyo.

if who NOM NVOL-FUT~first 3SG.NOM NOM AV.NVOL~FUT-get GEN prize

‘Whoever is first, it’s them<sub>SG</sub> that will get a prize.’

<sup>9</sup>Oblique marking (*sa*) on free relatives and embedded questions is possible in certain contexts, although this may be restricted to more colloquial registers. This is perhaps expected given that the oblique marker is not a determiner, as I argued in Sec. 2.4.2.

(i) P<in>akingg-an namin ang kwento ni lolo tungkol \*(sa) kung paano niya na-kilala  
<PFV>-listen-LV 1PL.EXCL.GEN NOM story GEN.P grandpa about OBL if how 3SG.GEN NVOL.PFV-acquaint[PV]  
si lola.  
NOM.P grandma  
‘We listened to grandpa’s story about how he met grandma.’

- b. [**Kung saan** naka-lagay ang mga baso]<sub>i</sub>, doon<sub>i</sub> mo ma-ha~hanap ang mga plato.  
 if where STAT-put NOM PL glass DIST.OBL 2SG.GEN NVOL-FUT~find[PV] NOM PL plate  
 ‘Wherever the glasses are stored, it’s there that you can find the plates.’

(28) \*Maka~ka-kuha ng premyo **kung sino** ang ma-u~una.

AV.NVOL~FUT-get GEN prize if who NOM NVOL-FUT~first

Intended: ‘Whoever is first will get a prize.’ Ungrammatical post-verbal free relative (cf. 27a)

Given that *kung* marks a range of subordinate clause types (conditional and embedded interrogative clauses in particular), we can straightforwardly assume that it is an instance of the head Force<sup>0</sup>.

### 7.2.3 A word order puzzle (Sabbagh 2013)

A second (and perhaps more puzzling) detail about *kung*, pointed out by Sabbagh (2014), is that it consistently precedes the *wh*-expression in the relevant constructions. This problem is particularly acute for *kung*-RCs. Given our assumption that *kung* spells out Force<sup>0</sup>, and if we assume (as Rizzi does for Italian) that relative pronouns occupy the specifier of the ForceP, the *kung-wh* word order we see in (29a) should be impossible to generate. A left-side specifier predicts a *wh-kung* word order, while a right-side specifier predicts that the complement of Force<sup>0</sup> (whatever it may be) should linearly intervene between *kung* and the *wh*-expression. Neither of these word orders is attested, as we see for the examples in (29).

(29) ONLY THE *kung-wh* WORD ORDER IS POSSIBLE

- a. l<sup>á</sup>wà **kung saán** l<um>angóy ang mángingisdâ  
 lake if where <AV>swim(PFV) NOM fisherman

‘lake where the fisherman swam’

Attested *kung-wh* word order

- b. \*l<sup>á</sup>wà **saán kung** l<um>angóy ang mángingisdâ  
 lake where if <AV>swim(PFV) NOM fisherman

Intended: ‘lake where the fisherman swam’

Left-side specifier

- c. \*l<sup>á</sup>wà **kung** l<um>angóy ang mángingisdâ **saán**  
 lake if <AV>swim(PFV) NOM fisherman where

Intended: ‘lake where the fisherman swam’

Right-side specifier

The *kung-wh* word order is an issue in general for analyses that do not assume an articulated left periphery and simply have a CP projection, particularly because the word order illustrated in (29) is also found with embedded *wh*-questions and free relatives. One account of this problem is given by Sabbagh (2014), who proposes that the observed word order is derived by prosodically motivated lowering from Spec-CP to an adjunction position between C<sup>0</sup> and IP.

With respect to the surface position occupied by the *wh*-expression, Sabbagh (2014) observes that fronted non-DP interrogative phrases must follow the complementizer *kung*, as we have seen in (29), but must precede sentential negation and high adverbs, as (30) shows. He further assumes that high adverbs

adjoin to IP, since they must precede the verb, which he assumes has moved to I<sup>0</sup>, as (31) shows with *dapat* ‘must’.<sup>10</sup> The two pieces of evidence in (30-31) are thus taken to indicate that fronted non-DP *wh*-expressions occupy some position between C<sup>0</sup> and IP. Concretely, he assumes that the relevant XPs are high IP adjuncts.

(30) RELATIVE ORDERING OF *wh*-EXPRESSION WITH NEGATION AND HIGH ADVERBS (Sabbagh 2014)

- a. ... **kung** {paano} **dapat** {\*paano} k<um>ilos ang bata sa mga lugar gaya ng paaralan  
if how must <AV>behave NOM child OBL PL place such.as GEN school

o iba pa=ng pampubliko=ng lugar ...  
or other still=LK public=LK place

‘... how a child should behave at school or other public places ...’

High adverb (ex.15; glosses modified, ‘{\*paano}’ mine)

- b. ang dahilan **kung** {bakit} **hindi** {\*bakit} tayo maaari=ng lubos na ma-tuto ng  
NOM reason if why NEG 1PL.INCL.NOM can=LK complete LK AV-learn GEN

Ingles  
English

‘the reason why we can’t learn English that well’

Negation (exx.18–19; glosses modified)

## (31) HIGH ADVERBS PRECEDE THE VERB (Sabbagh 2014)

- a. **Dapat** ko=ng tupar-in ang aki[n]=ng pangako sa tao=ng iyon.  
must 1SG.GEN=LK fulfill-PV NOM 1SG.OBL=LK promise OBL person=LK DIST.NOM

‘I must keep my promise to that person.’

(ex.12a; glosses modified)

- b. \*Tupar-in ko=ng **dapat** ang aki[n]=ng pangako sa tao=ng iyon.  
fulfill-PV 1SG.GEN=LK must NOM 1SG.OBL=LK promise OBL person=LK DIST.NOM

Intended: ‘I must keep my promise to that person.’

(ex.13a; glosses modified)

Sabbagh (2014) further argues that *wh*-expressions come to occupy the observed position between C<sup>0</sup> and IP through a process of lowering. That is, non-DP *wh*-expressions first occupy Spec-CP (e.g., after having undergone *wh*-movement) but must lower and adjoin to IP due to a proposed prosodic constraint. Of the evidence presented in support of this approach, perhaps the most compelling is the behavior exhibited by *kung+wh* constructions under coordination. As (32) shows, coordination of two embedded questions requires that both conjuncts be marked with *kung*. Sabbagh (p.17) argues that this behavior is unexpected under the view that the *wh*-expression straightforwardly adjoins to IP, as the absence of the second *kung* would be predicted possible as an instance of IP coordination. Instead, he argues (p.19) that this data can be understood if fronted (non-DP) *wh*-phrases occupy Spec-CP at the point

<sup>10</sup>It should be noted, however, that the status of *dapat* ‘must’ in this example as an adjunct is perhaps not so clear cut. Notably, the apparent main verb in the clause, *tuparin* ‘fulfill (PV)’ is in the aspectless form (see Sec. 2.3), which normally only appears in various kinds of subordinate clause types. This in turn suggests that *dapat* could in fact be closer to an auxiliary of some sort than an adverb. Similar behavior can be seen in (30a) with another instance of *dapat* and the verb *kumilos* ‘behave, act (AV)’ (although <um> verbs have homophonous aspectless and perfective forms), as well as in (30b) with *maaari* ‘can’ and *matuto* ‘learn (AV)’. I follow Sabbagh’s (2014) interpretation of the data as originally presented for the sake of discussion.



of coordination. Coordinating embedded *wh*-questions would thus require coordinating CPs (not IPs), which in turn predicts two instances of *kung*, which is assumed to spell out  $C^0$ .

(32) COORDINATION OF *kung+wh*

Ang mga s<um>a~sagot sa mga pag-bati na ito ay hindi kailanga[n]=ng sabih-in [**kung**  
 NOM PL AV.IMPF~answer OBL PL pag-greet LK PROX TOP NEG need=LK say-PV if  
 saan talaga sila pu~punta ] o [??(**kung**) saan sila nang-gáling].  
 where really 3PL.NOM FUT~go[AV] or if where 3PL.NOM AV.PFV-come.from

‘[Those who respond] to these greetings need not really say where [they are] going or where [they have] been.’  
 (Sabbagh 2014, ex.32; glosses, translation modified)

Sabbagh (2014) also contrasts the behavior of fronted non-DP *wh*-expressions with another fronted XP appearing at the clause edge: *ay*-inversion topics. These exhibit similar word ordering behavior to fronted *wh*-expressions, specifically appearing between *kung* and negation as we see in (33), and so are assumed to also appear in a syntactic position between  $C^0$  and IP. Concretely, again, Sabbagh assumes that these are also adjoined to IP.

(33) *Kung* > *Ay*-TOPIC > NEGATION

(Sabbagh 2014)

a. ... {\*ang bibilhin mo} **kung** {ang bi~bilh-in mo} ay isa=ng NEED o isa lamang WANT  
 if NOM FUT-buy-PV 2SG.GEN TOP one=LK need or one only want  
 ‘... whether your purchase is a need or just a want’ (exx.22–23; truncated, glosses modified)

b. *kung* {ang mga kabataan ay} **hindi** {\*ang mga kabataan ay} maka-basa  
 if NOM PL young.people TOP NEG NVOL.AV-read  
 ‘if young people are not able to read’ (exx.24a,25; glosses, translation modified)<sup>11</sup>

Unlike what we saw with fronted *wh*-expressions, however, coordinating embedded clauses with *ay*-topics does *not* require two instances of *kung*. We see this in (34). For Sabbagh (2014) then, this example has the structure of IP coordination within a single embedded CP, and shows us a case where XPs *can* straightforwardly adjoin to IP, unlike what was argued for *wh*-expressions.

(34) COORDINATION OF EMBEDDED *ay*-INVERSION

sa panahon ng globalisasyon [**kung** kailan [ang lahat ay maaari nati[n]=ng  
 OBL time GEN globalization if when NOM all TOP can 1PL.INCL.GEN=LK  
 ma-angkin], o [ang lahat ay maaari=ng <um>angkin sa atin]]  
 NVOL-possess[PV] or NOM all TOP can=LK <AV>possess OBL 1PL.INCL.OBL

‘in this time of globalization, when we can have everything or everything can have us’  
 (Sabbagh 2014, ex.33; glosses modified)

Overall, then, Sabbagh’s (2014) prosodic lowering analysis assumes that *ay*-topics and fronted non-DP *wh*-expressions are both adjoined to IP, and accounts for the behavioral asymmetries they exhibit

<sup>11</sup>Sabbagh (2014) provides this example as a matrix question, noting in a footnote (fn.11) that it is a rare example of *kung* appearing in a matrix clause. I judge this usage of *kung* to be ungrammatical, although it is possible that the original example occurred in a written list of embedded questions, each beginning with *kung* and ending in an orthographic question mark.

by proposing different derivational routes to reach this adjunction site. Crucially, *wh*-expressions are assumed to undergo lowering from Spec-CP to the adjunction site, while *ay*-topics are assumed to adjoin to IP in a more straightforward manner. However, much of the behavior discussed by Sabbagh is also readily accounted for under Rizzi's (1997) articulated left periphery framework without having to propose the additional mechanism of prosodically-motivated lowering. For example, if we assume that non-DP interrogative *wh*-expressions occupy Spec-FocP, even in embedded questions, then we derive the *kung-wh* word order in embedded *wh*-questions, since Force<sup>0</sup> (i.e., *kung*) c-commands Spec-FocP.

Similarly, Sabbagh observes that a clause can contain multiple *ay*-topics, but only one fronted *wh*-expression. Under the prosodic lowering analysis, this difference stems from the aforementioned derivational differences between the two types of fronted constituents. *Ay*-topics are derived by plain adjunction, which is an inherently recursive or repeatable operation, so we expect it to be possible to have multiple instances in a clause. On the other hand, fronted *wh*-expressions are associated with Spec-CP, an inherently less recursive position, and only adjoin to IP as a result of prosodic lowering, thus explaining why only one is possible per clause. For the articulated left periphery approach, this difference can be naturally captured by the proposed recursive nature of TopP (explaining multiple *ay*-topics), and the contrasting non-recursive nature of FocP (whose specifier hosts *wh*-expressions that have undergone A'-movement). Detailed discussion and motivation for these different syntactic positions for Tagalog is presented in Section 7.3.

Adopting an articulated left periphery approach also allows us to account for more fine-grained structural distinctions between different *kung+wh* constructions, as discussed in the next section. Particularly, we will see evidence that the *wh*-expression in a *kung*-RC occupies a different syntactic position from those found in embedded questions and free relatives. This poses a problem for the prosodic lowering analysis, since it assumes a uniform surface position for *wh*-expressions, and therefore cannot readily account for these asymmetries.

Even the coordination data, which is the most compelling piece of evidence presented by Sabbagh for a strong connection between *kung* and the fronted *wh*-expressions, can be called into question. Although Sabbagh states that the second instance of *kung* may not be omitted in cases that have coordination like (32) above, he does not mark the omission as fully ungrammatical in the relevant example sentences. This suggests that the effect is potentially weak or variable, as confirmed by (35) which my consultants have judged as acceptable regardless of the presence of the second *kung*.

- (35) Ayaw niya=ng sabih-in [**kung** saan siya pu~punta] o [(**kung**) kailan siya  
 NEG.want 3SG.GEN=LK say-PV if when 3SG.NOM FUT~go[AV] or if when 3SG.NOM  
 ba~balik].  
 FUT~return[AV]

'They<sub>sc</sub> don't want to say [where they<sub>sc</sub> are going] or [when they<sub>sc</sub> are coming back].'

The major detail that does not carry over from Rizzi's account of the Italian left periphery is the position of *relative* pronouns in Spec-ForceP. Rizzi proposes this position for these pronouns because they must linearly precede topics, and under his proposed structure, the only position where this linear precedence is ensured is Spec-ForceP. Given the word order data presented above, I depart from Rizzi and

propose that Tagalog has a RelP projection below ForceP, somewhere in the topic/focus field.<sup>12</sup>

In the next sections, I motivate the different positions and projections within the topic/focus field in Tagalog, using mostly the same kind of data that Rizzi (1997) provides for Italian. In particular, we will see that despite their shared signature *kung+wh*, *kung*-RCs have a different structure to embedded *wh*-questions and free relatives. This difference precludes an initially appealing hypothesis regarding the derivation of *kung*-RCs, which is that they stem derivationally from *wh*-questions.

### 7.3 Fronting constructions and constituent ordering

We now turn our focus to various fronting constructions in Tagalog, including those that exhibit the signature *kung+wh* sequence. The goal of this discussion will be to motivate the positions of the various projections in the topic/focus field for Tagalog. Specifically, we will see that Tagalog left periphery has the structure outlined in (36).

- (36) PROPOSED LEFT PERIPHERY FOR TAGALOG  
ForceP > RelP > TopP\* > FocP > FinP

A major claim of this section is thus that the *kung+wh* constructions do not comprise a natural class of constructions, and that, in particular, *kung*-RCs are distinct from the others. The primary way that this distinctness manifests is in the position occupied by the *wh*-expression: relative pronouns occupy Spec-RelP, while interrogative pronouns occupy Spec-FocP. These positions will be motivated primarily by a number of word order facts. However, the *kung+wh* constructions can also be distinguished by their distributions, which I turn to first.

#### 7.3.1 Different distributions between *kung+wh* constructions

*Kung*-RCs have a distinctly narrower distribution than both embedded *wh*-questions and free relatives. As we have seen previously in Section 4.1.2, DP positions cannot be relativized using the *kung*-RC strategy. This restriction contrasts with the fact that the other two *kung+wh* constructions are compatible with DP targets, which we have seen previously in this chapter. This difference is illustrated in (37).

- (37) DP-TARGETED *kung+wh* CONSTRUCTIONS

- a. \*Ka~kausáp-in ni Tina ang bisita **kung síno** (ang) d<um>atíng.  
FUT~speak.with-PV GEN.P Tina NOM guest if who NOM <AV>arrive(PFV)

Intended: 'Tina will speak with the guest who arrived.'

\**Kung* relative clause

- b. T<in>anóng ng gúro **kung síno** ang d<um>atíng.  
<PFV>ask[PV] GEN teacher if who NOM <AV>arrive(PFV)

'The teacher asked who arrived.'

Embedded question (repeated from 24a)

<sup>12</sup>Note that Force<sup>0</sup> is null in Italian relative clauses when an overt relative pronoun is present. On Rizzi's proposal that relative pronouns occupy Spec-ForceP, this complementary distribution can be understood as a Doubly-filled Comp Filter effect. However, these facts are also compatible to some extent with a landing site for relative pronouns that is asymmetrically c-commanded by Force<sup>0</sup>, as I suggest here with Spec-RelP.

- c. Ka~kausáp-in ni Tina **kung sino** ang d<um>atíng.  
 FUT~speak.with-PV GEN.P Tina if who NOM <AV>arrive(PFV)  
 ‘Tina will speak with whoever arrived.’ Free relative (repeated from 25a)

This difference in distribution is important, as it teases apart an apparent symmetry when considering only those *kung+wh* constructions that target non-DPs. As we see in (38), *kung*-RCs of non-DPs, which are grammatical, are surface-identical to embedded questions and free relatives. Based on this data alone, we might posit that the surface parallelism is due to the three constructions having identical structures. The data in (37) shows us that such an analysis is not correct.

(38) NON-DP-TARGETED *kung+wh* CONSTRUCTIONS

- a. Bi~bili ako ng damit sa tindahan **kung saán** p<um>untá ang estudyánte.  
 FUT~buy[AV] 1SG.NOM GEN clothing OBL store if where <AV>go(PFV) NOM student  
 ‘I will buy clothes at the store where the student went.’ *Kung* relative clause
- b. T<in>anóng ng gúro **kung saán** p<um>untá ang estudyánte.  
 <PFV>ask[PV] GEN teacher if where <AV>go(PFV) NOM student  
 ‘The teacher asked where the student went.’ Embedded question (repeated from 24b)
- c. A~alís si Jojo [**kung kailán** a~alís si Kiko].  
 FUT~leave[AV] NOM.P Jojo if when FUT~leave[AV] NOM.P Kiko  
 ‘Jojo will leave whenever Kiko leaves.’ Free relative (repeated from 25b)

Along these lines, it is important to point out that the attempted DP *kung*-RC in (37a) is ungrammatical regardless of whether or not there is an intermediary *ang* after the *wh*-expression.<sup>13</sup> This behavior contrasts with embedded questions and free relatives of DPs like (37b-c), where the intermediary *ang* is required. In other words, the DP *kung*-RC is ungrammatical, even if we make it (superficially) parallel to the corresponding embedded question and free relative constructions. Again, this behavior runs counter to the expectation just discussed, that we might have formed based on the behavior of the non-DP-targeted *kung+wh* constructions in (38).<sup>14</sup> The distribution discussed so far is summarized in Table 7.1.

Table 7.1: Distribution of *kung+wh* constructions based on target

|                                     | DP                                                                                                                                                   | Non-DP                                                                  |
|-------------------------------------|------------------------------------------------------------------------------------------------------------------------------------------------------|-------------------------------------------------------------------------|
| Relative Clauses                    | <del><b><i>Kung</i>-RC</b></del> (Linker RC only)<br><sup>*</sup> HEAD <i>kung</i> [ WH ( <i>ang</i> ) [ V ... ] ]<br><sup>✓</sup> HEAD LK [ V ... ] | <b><i>Kung</i>-RC</b><br>HEAD <i>kung</i> [WH [ V ... ] ]               |
| Free Relatives & Embedded Questions | <b><i>Kung</i> + Pseudocleft</b><br><i>kung</i> [WH <i>ang</i> [ V (CL) ... ] ]                                                                      | <b><i>Kung</i> + Focus fronting</b><br><i>kung</i> [WH (CL) [ V ... ] ] |

<sup>13</sup>Previous examples, particularly those in Chapter 4, show attempted DP *kung*-RCs without the intermediary *ang*. Following the discussion here, adding this *ang* to those examples does not improve their ill-formedness.

<sup>14</sup>The examples in (37) also tell us that ungrammaticality of DP-targeted *kung*-RCs cannot be due to some general ban on the co-occurrence of *kung* with *sino* ‘who’ (and *ano* ‘what’), as such sequences are in fact attested with free relatives and embedded questions.

Further differences can be found when we consider constructions that target oblique positions that are individual-denoting. For this data, there is some variation in acceptability judgments from native speakers, so more detailed research is needed to ascertain the root of this variability. However, the pattern we saw in (37) is mirrored in that *kung*-RCs have a more limited distribution compared to the other two constructions. We see in (39) that *kung*-RCs targeting individual-denoting oblique-marked positions are not always accepted by speakers. This behavior contrasts with that of embedded questions and free relatives in that speakers judge them to be unremarkable.

## (39) ASYMMETRY IN TARGETING INDIVIDUAL-DENOTING OBLIQUE POSITIONS

- a. I-b<in>igay ni Gino ang tsaa kay Inday.  
 CV-<PFV>give GEN Gino NOM tea OBL Inday  
 ‘Gino gave the tea to Inday.’ Baseline
- b. T<in>anong ko kung kanino i-b<in>igay ni Gino ang tsaa.  
 <PFV>ask[PV] 1SG.GEN if who.OBL CV-<PFV>give GEN Gino NOM tea  
 ‘I asked to whom Gino gave the tea.’ Embedded question
- c. I-b<in>igay ko ang asukal kung kanino i-b<in>igay ni Gino ang tsaa.  
 CV-<PFV>give 1SG.GEN NOM sugar if who.OBL CV-<PFV>give GEN Gino NOM tea  
 ‘I gave the sugar to whoever Gino gave the tea to.’ Free relative
- d. ?I-b<in>igay ko ang asukal sa tao kung kanino i-b<in>igay ni Gino ang tsaa.  
 CV-<PFV>give 1SG.GEN NOM sugar OBL person if who.OBL CV-<PFV>give GEN Gino NOM tea  
 Intended: ‘I gave the sugar to the person who Gino gave the tea to.’ *Kung* relative clause

We have thus seen that *kung*-RCs are more limited with respect to the positions they can target when compared to other superficially similar *kung+wh* constructions. This restriction excludes an intuitive initial hypothesis about the derivation of *kung*-RCs: that they are derived from (matrix) *wh*-questions, as is more transparently the case with embedded questions. Maintaining such a view would require positing a mechanism to explain the comparatively more limited distribution that we find for *kung*-RCs. I set aside the question of what such a mechanism might be and instead take this data—particularly the inaccessibility of DPs as shown in (37)—as evidence that the derivation of *kung*-RCs involves movement of the relative pronoun to a dedicated syntactic position, Spec-RelP, that is distinct from the position occupied by interrogative pronouns. This approach is further supported by various word-order and co-occurrence restrictions, which we now turn to.<sup>15</sup>

### 7.3.2 Focus and *wh*

Rizzi (1997) assumes for Italian that the *wh*-expression in a question competes for the same position as a focus phrase. Given the discussion in Chapter 4 (see also Aldridge 2002; Mercado 2004) showing that

<sup>15</sup>In this thesis, I do not develop a detailed analysis of DP-targeted embedded questions like (37b) and free relatives like (37c). However, as discussed in Sec. 7.3.4, I assume that *kung* may straightforwardly take a DP-targeted question (i.e., a pseudocleft with a *wh*-expression predicate) as its complement, resulting in the constructions in questions. This of course leaves a number of issues unaddressed, particularly with regards to the semantics of free relatives, that I will set aside for the purposes of this thesis.

Tagalog consistently uses the relevant focus constructions (i.e., pseudoclefts or focus fronting) to form questions, this assumption from Rizzi naturally extends to Tagalog. This is particularly true for focus fronting of non-DPs, which I argue here is derived similarly to what Rizzi proposes for Italian.<sup>16</sup> Further evidence for this claim comes in the form of co-occurrence restrictions between *wh*-interrogatives and focus phrases, parallel to what Rizzi (1997, ex.45) shows for Italian. The examples in (40) provide attempted examples of (non-interrogative) focus fronting occurring within a non-DP *wh*-question. These examples show that both relative orderings of the *wh*-expression (italicized) and the focus phrase are ungrammatical.

(40) *Wh*- AND NON-*wh* FOCUS FRONTING CANNOT CO-OCCUR IN MATRIX QUESTIONS

- a. \*{*Saan*} sa kanya {*saan*} i-b<in>igay ang gantimpala?  
 where OBL 3SG.OBL CV-<PFV>give NOM prize  
 Intended: 'Where was the prize given TO THEM<sub>SG</sub>?'
- b. \*{*Kanino*} sa silid-aralan {*kanino*} i-b<in>igay ang gantimpala?  
 who.OBL OBL classroom CV-<PFV>give NOM prize  
 Intended: 'To whom was the prize given IN THE CLASSROOM?'<sup>17</sup>

We find the same behavior in embedded questions, as shown in (41).

(41) *Wh*- AND NON-*wh* FOCUS FRONTING CANNOT CO-OCCUR IN EMBEDDED QUESTIONS

- a. \*T<in>anong ng punong-guro [kung {*saan*} sa kanya {*saan*} i-b<in>igay ang gantimpala].  
 <PFV>ask[PV] GEN principal if where OBL 3SG.OBL CV-<PFV>give NOM prize  
 'The principal asked [where the prize was given TO THEM<sub>SG</sub>].'
- b. \*T<in>anong ng punong-guro [kung {*kanino*} sa silid-aralan {*kanino*} i-b<in>igay ang  
 <PFV>ask[PV] GEN principal if who.OBL OBL classroom CV-<PFV>give NOM  
 gantimpala].  
 prize  
 'The principal asked [to whom the prize was given IN THE CLASSROOM].'

(42) *Wh*- AND NON-*wh* FOCUS FRONTING CANNOT CO-OCCUR IN FREE RELATIVES

- a. \*[Kung {*saan*} sa kanya {*saan*} i-b<in>igay ang gantimpala], doon tayo  
 if where OBL 3SG.OBL CV-<PFV>give NOM prize DIST.OBL 1PL.INCL.NOM  
 mag-ki~kita.  
 AV-FUT~see  
 '[Wherever the prize was given TO THEM<sub>SG</sub>], that's where we will meet.'

<sup>16</sup>DP focus and *wh*-questions show the same parallelism, but, as argued in this thesis, do not involve movement to Spec-FocP. As argued in Chapter 5, DP focus and *wh*-expressions occupy the syntactic predicate position of a DP-DP copular clause.

<sup>17</sup>With *kanino sa silid-aralan*, this example may be grammatical with a meaning of '[To whom in this classroom] was the prize given?'

- b. \*[Kung {*kanino*} sa silid-aralan {*kanino*} i-b<in>igay ang gantimpala], sa kanya ako  
 if who.OBL OBL classroom CV-<PFV>give NOM prize OBL 3SG.OBL 1SG.NOM  
 hi~hingi ng tulong.  
 FUT~request[AV] GEN help

‘[To whom the prize was given IN THE CLASSROOM], that’s who I will ask for help from.’

Following Rizzi (1997), I take this behavior to indicate that non-DP *wh*-expressions and focus phrases occupy the same position of Spec-FocP. We can contrast this behavior just demonstrated with the behavior of *kung*-RCs. Unlike the *wh*-expressions in (non-DP) questions, those in *kung*-RCs can co-occur with a focus phrase. Furthermore, these two elements have a fixed relative word order of *wh*-focus, as shown in (43).

(43) RELATIVE PRONOUN CAN CO-OCCUR WITH (NON-*wh*) FOCUS FRONTING

- a. ang silid-aralan [kung {*saan*} sa kanya {*\*saan*} i-b<in>igay ang gantimpala]  
 NOM classroom if where OBL 3SG.OBL CV-<PFV>give NOM prize  
 ‘the classroom [where the prize was given TO THEM<sub>sc</sub>] (not to someone else)’
- b. ang mag-aarál [kung {*kanino*} sa silid-aralan {*\*kanino*} i-b<in>igay ang gantimpala]  
 NOM student if who.OBL OBL classroom CV-<PFV>give NOM prize  
 ‘the student [who was given the prize IN THE CLASSROOM] (not somewhere else)’

We can take this behavior by itself as evidence that RelP is hierarchically above FocP in the left periphery, however, we will see later in Section 7.3.4 that there is a general adjacency requirement between *kung* and the *wh*-expression that presents a confound. For now, then, I make a weaker claim about differing syntactic positions, rather than about hierarchical structure. That is, given that relative pronouns can co-occur with focus phrases, they must occupy different syntactic positions; I assume Spec-RelP and Spec-FocP. This then means that relative pronouns also occupy a different position from interrogative ones, which I have argued to be situated in Spec-FocP.<sup>18</sup> This difference in syntactic position for the *wh*-expression thus supports the claim made in the previous section that *kung*-RCs differ from other *kung+wh* constructions. The hierarchy of projections just described is schematized in (44).

(44) HIERARCHY OF LEFT-PERIPHERAL ELEMENTS IN *kung+wh* CONSTRUCTIONS

ForceP > RelP > FocP  
 (*kung*) > (*Wh*<sub>Rel</sub>) > (Focus/*Wh*<sub>Q</sub>)

<sup>18</sup>Relative and interrogative pronouns cannot appear in the same clause, as (i) shows. I assume that this is because *wh*-in-situ is generally a marked strategy in Tagalog, and that *wh*-interrogatives must appear at the left periphery of the clause they take interrogative force in.

(i)\*ang silid-aralan [kung {*saan*} *kanino* {*\*saan*} i-b<in>igay ang gantimpala]  
 NOM classroom if where who.OBL CV-<PFV>give NOM prize  
 Intended: ‘the classroom [where the prize was given to whom]’

### 7.3.3 Second position clitics

The difference in syntactic structure argued for in the previous subsection is also supported by the behavior of second position clitics. Recall from Section 4.2.3 that these clitics diagnose structural differences between pseudoclefts and focus fronting (i.e., DP vs non-DP focus). In particular, we saw that clitic pronouns had different placement behavior in pseudoclefts compared to focus fronting. The relevant data is repeated in (45). With the pseudocleft in (45b), the pronoun *niya* cliticizes onto the verb, whereas with the focus fronting in (45c), the pronoun cliticizes onto the focus constituent.<sup>19</sup> Cliticization to the focus constituent in a pseudocleft—and to the verb with focus fronting—is ungrammatical.

(45) CLITIC PLACEMENT DIAGNOSES STRUCTURE IN FOCUS CONSTRUCTIONS

- a. I-ha~hagis **niya** ang bola sa aso.  
 CV-FUT~toss 3SG.GEN NOM ball OBL dog  
 ‘They<sub>SG</sub> will toss the ball to the dog.’ Baseline
- b. Ang bola {**\*niya**} ang i-ha~hagis {**niya**} sa aso.  
 NOM ball NOM CV-FUT~toss 3SG.GEN OBL dog  
 ‘What they<sub>SG</sub> will toss to the dog is the ball.’ Pseudocleft
- c. Sa aso {**niya**} i-ha~hagis {**\*niya**} ang bola.  
 OBL dog 3SG.GEN CV-FUT~toss NOM ball  
 ‘It’s to the dog that they<sub>SG</sub> will toss the ball.’ Focus fronting

Recall also that beyond a general indication of different structures, the clitic placement patterns diagnose the structural positions of the focus constituents. Specifically, these clitic placement facts tell us that the focus position for focus fronting is *inside* the domain for determination of clitic placement, while the position for pseudoclefts lies *outside* this domain. In relation to the articulated left periphery, these facts tell us that FocP lies within this clitic placement domain. Given the claim made in the previous subsection that relative and interrogative pronouns occupy different positions, it is perhaps not surprising that we would find differences in clitic placement behavior among the *kung+wh* constructions.

Embedded questions and free relatives behave identically to their respective matrix counterparts. That is, embedded DP questions and DP free relatives (46) pattern like matrix pseudoclefts (45b), showing post-verbal cliticization. On the other hand the non-DP versions (47) pattern like matrix focus fronting (45c), showing post-*wh* cliticization.

<sup>19</sup>As with the discussion in Sec. 4.2.3, I use “cliticizes to the verb” and “post-verbal” in this discussion as a shorthand to refer to cliticization to any position below (or linearly after) the focus constituent. For example, if the verb in (45) were negated with *hindi*, as in (i), the negator would precede the verb, and the pronoun would in turn cliticize to the negator. This would still be considered “cliticization to the verb” for current purposes.

(i) Ang bola {**\*niya**} ang *hindi* {**niya**} i-ha~hagis {**\*niya**} sa aso.  
 NOM ball NOM NEG 3SG.GEN CV-FUT~toss OBL dog  
 ‘What they<sub>SG</sub> will *not* toss to the dog is the ball.’



## (46) POST-VERBAL CLITICIZATION FOR DP EMBEDDED QUESTIONS AND FREE RELATIVES

- a. Hindi ko alam [kung ano **{\*niya}** ang i-ha~hagis **{niya}** sa aso].  
 NEG 1SG.GEN know if what 3SG.GEN NOM CV-FUT~toss OBL dog  
 ‘I don’t know [where they<sub>SG</sub> will toss the ball].’ Embedded DP question
- b. [Kung ano **{\*mo}** ang i-ha~hagis **{mo}** sa kanya], iyon ang ha~habul-in ng aso.  
 if what 2SG.GEN NOM CV-FUT~toss OBL 3SG.OBL DIST(NOM) NOM FUT~chase-PV GEN dog  
 ‘[Wherever you will toss the ball], it’s there that the dog will go.’ DP Free relative

## (47) POST-WH CLITICIZATION FOR NON-DP EMBEDDED QUESTIONS AND FREE RELATIVES

- a. Hindi ko alam [kung saan **{niya}** i-ha~hagis **{\*niya}** ang bola].  
 NEG 1SG.GEN know if where 3SG.GEN CV-FUT~toss NOM ball  
 ‘I don’t know [where they<sub>SG</sub> will toss the ball].’ Embedded non-DP question
- b. [Kung saan **{mo}** i-ha~hagis **{\*mo}** ang bola], doon pu~punta ang aso.  
 if where 2SG.GEN CV-FUT~toss NOM ball DIST.OBL FUT~go[AV] NOM dog  
 ‘[Wherever you will toss the ball], it’s there that the dog will go.’ Free relative

We find a contrast when we consider *kung*-RCs, as exemplified in (48). As we might expect from embedded non-DP questions and non-DP free relatives, cliticization to the *wh*-expression is possible. Unlike these constructions however, we also see that cliticization to the verb is possible with (necessarily non-DP) *kung*-RCs.<sup>20</sup> The clitic placement patterns for these non-DP *kung+wh* constructions are represented schematically in (49) for comparison.

- (48) Pu~punta ang aso sa lugar [kung saan **{niya}** i-ha~hagis **{niya}** ang bola].  
 FUT~go[AV] NOM dog OBL place if where 3SG.GEN CV-FUT~toss 3SG.GEN NOM ball  
 ‘The dog will go to the place [where they<sub>SG</sub> will toss the ball].’ *Kung* relative clause

(49) CLITIC PLACEMENT SCHEMATIC FOR NON-DP *kung+wh* CONSTRUCTIONS

|                                                |             |                     |                                                                |     |                                                                 |                          |
|------------------------------------------------|-------------|---------------------|----------------------------------------------------------------|-----|-----------------------------------------------------------------|--------------------------|
| <b><i>Kung</i> Relative Clauses</b>            | <i>kung</i> | [ WH <sub>Rel</sub> | <span style="border: 1px solid black; padding: 2px;">CL</span> | V   | ... ]                                                           | → ✓ Low <i>wh</i>        |
|                                                | <i>kung</i> | WH <sub>Rel</sub>   |                                                                | [ V | <span style="border: 1px solid black; padding: 2px;">CL</span>  | ... ] → ✓ High <i>wh</i> |
| <b>Free Relatives &amp; Embedded Questions</b> | <i>kung</i> | [ WH/FOC            | <span style="border: 1px solid black; padding: 2px;">CL</span> | V   | ... ]                                                           | → ✓ Low <i>wh</i>        |
|                                                | <i>kung</i> | WH/FOC              |                                                                | [ V | <span style="border: 1px solid black; padding: 2px;">*CL</span> | ... ] → ✗ High <i>wh</i> |

Following the reasoning behind the comparison of pseudoclefts and focus fronting, I take the availability of the lower post-verbal cliticization site to indicate that *kung*-RCs have a high syntactic position available for the *wh*-expression. Crucially, this position must be above FocP, since, as we have seen with focus fronting, clitics may climb up to elements in Spec-FocP. Assuming that the landing site for the relative pronoun is Spec-RelP, this behavior gives us evidence that RelP is structurally higher than FocP in the left periphery. I assume that RelP occurs directly below ForceP.

<sup>20</sup>In fact, the post-verbal position appears to occasionally be slightly preferred over the post-*wh* position for this construction.

Furthermore, I take the optionality in clitic placement to be evidence for optionality in the surface position of the *wh*-expression in *kung*-RCs.<sup>21</sup> I assume that the *wh*-expression position corresponds to Spec-FocP. We see some evidence for this in (50), for example, where the optionality in clitic placement disappears when a clear focus phrase co-occurs with a relative pronoun. Three clitic positions are indicated in these examples: post-*wh*, post-focus, and post-verbal. Because a clear focus phrase occupies Spec-FocP, we expect that cliticization to the post-verbal position should be impossible, as we saw previously in (47). For similar reasons, the availability of post-focus cliticization is also expected. The significant detail in these examples is that, unlike in (48), the post-*wh* cliticization position is no longer available. If we assume that in (48), the post-*wh* position for clitics is associated with the relative pronoun being in Spec-FocP, then we can tie the impossibility of post-*wh* cliticization in (50) to the fact that Spec-FocP is occupied by a focus phrase, and therefore cannot serve as a landing site for the *wh*-expression. A schematic representation of the examples in (50) is provided in (50c).

(50) CLITIC PLACEMENT IN *kung*-RC WITH FOCUS FRONTING

- a. ang silid-aralan [kung saan {\*nila} sa kanya {nila} i-b<in>igay {\*nila} ang gantimpala]  
 NOM classroom if where OBL 3SG.OBL 3PL.GEN CV-<PFV>give NOM prize  
 ‘the classroom [where they gave the prize TO THEM<sub>SG</sub>]’
- b. ang mag-aarál [kung kanino {\*nila} sa silid-aralan {nila} i-b<in>igay {\*nila} ang gantimpala]  
 NOM student if who.OBL OBL classroom 3PL.GEN CV-<PFV>give NOM prize  
 ‘the student [who was given the prize IN THE CLASSROOM]’
- c. SCHEMA: *kung* WH<sub>Rel</sub> [ \*CL ] [ FOC [ CL ] V [ \*CL ] ... ] → Obligatorily high WH<sub>Rel</sub>

So far, I have discussed two positions in the left periphery: Spec-FocP and Spec-RelP. I have assumed that Spec-FocP is the landing site for focus fronting of non-DPs, and argued, following previous work on Tagalog and other languages (Rizzi 1997; Aldridge 2002; Mercado 2004), that this position is also occupied by *wh*-interrogatives. On the other hand, I have argued that Spec-RelP is a higher position than Spec-FocP in the left periphery that is occupied by relative pronoun *wh*-expressions (which may themselves also occupy Spec-FocP). This different position was evidenced by the fact that relative pronouns can co-occur with focus, as well as the different cliticization patterns between *kung*-RCs and focus fronting constructions. These patterns are summarized in Table 7.2.

Table 7.2: Cliticization patterns with non-DP fronting constructions

|                        | <i>Kung+wh</i>  |           |                  |                  | Position of <i>wh</i> |
|------------------------|-----------------|-----------|------------------|------------------|-----------------------|
|                        | <i>Kung</i> -RC | Free Rel. | Emb. <i>Wh</i> Q | Mat. <i>Wh</i> Q |                       |
| Post-verbal clitic     | ✓               | ✗         | ✗                | ✗                | High (Spec-RelP)      |
| Post- <i>wh</i> clitic | ✓               | ✓         | ✓                | ✓                | Low (Spec-FocP)       |

<sup>21</sup>Whether we this variability is an instance of true optionality or is instead conditioned on some other factor is left as an open question. One possibility which I have briefly investigated is that this might be tied to a restrictive/non-restrictive distinction. The preliminary data I gathered was inconclusive, so this is left for future work.

### 7.3.4 *Ay*-inversion

We now consider the other left-peripheral projection that Rizzi (1997) proposes: TopP. Specifically, I will discuss the *ay*-inversion topicalization process briefly introduced in Section 4.2 (see also Schachter and Otones 1972, §7.2). The behavior of *ay*-inversion with respect to the other constructions involving the clausal left periphery motivates TopP as an intermediate projection between RelP and FocP, as shown in (51). This structural position most clearly seen in matrix clauses. On the other hand, the data in embedded contexts is obscured somewhat by an adjacency requirement between *kung* and the *wh*-expression in *kung+wh* constructions. I account for this adjacency requirement by positing that if a left-peripheral projection has a *wh*-expression in its specifier, then *kung* (i.e., Force<sup>0</sup>) must select that projection as its complement.

(51) PROPOSED HIERARCHY OF PROJECTIONS FOR TAGALOG

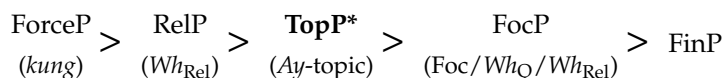

#### 7.3.4.1 Overview

With *ay*-inversion, a topic phrase appears in a pre-predicate position, followed by an invariant particle *ay*, which may optionally contract as =*y* in certain phonological contexts.<sup>22</sup> I take the particle *ay* to instantiate Top<sup>0</sup>, and the fronted phrase to be located in Spec-TopP. Some basic examples are provided in (52-53). We also find instances of multiple topics, as (54) shows with a multiple *ay*-inversion construction and an example showing *ay*-inversion with a prosodic topicalization strategy.

(52) *Ay*-INVERSION OF A NOMINATIVE DP

(Schachter and Otones 1972, p.486)

a. Mabait na mabait **kayo**.

kind LK kind 2PL.NOM.

'You are very kind.'

Baseline

b. **Kayo**=*y* mabait na mabait.

2PL.NOM=TOP kind LK kind

'You are very kind.'

(53) *Ay*-INVERSION OF AN OBLIQUE PHRASE

a. I-s<in>ulat ni Tina ang sagot **sa pisara**.

CV-<PFV>write GEN Tina NOM answer OBL blackboard

'Tina wrote the answer on the blackboard.'

Baseline

<sup>22</sup>Here, I am simplifying the characterization of *ay*-inversion for the sake of discussion. The pre-predicate "topic" phrase is often interpreted as an information-structural topic, but cases exist where the topic status of this phrase is less clear (see, e.g., (87) in sec. 7.4.3). Similarly, "inversion" suggests movement from a base position (or some other kind of transformation), but we also find cases where the topic phrase is not clearly associated with a pre-inversion base position. See Schachter and Otones 1972, §7.2 for examples, and Kroeger 1993, pp.61–8 for discussion.

- b. **Sa pisara** ay i-s<in>ulat ni Tina ang sagot.  
 OBL blackboard TOP CV-<PFV>write GEN.P Tina NOM answer  
 ‘Tina wrote the answer on the blackboard.’

## (54) MULTIPLE TOPIC CONSTRUCTIONS

(Schachter and Otones 1972)

- a. **Bukas** ay kami=*y* pu~punta.  
 tomorrow TOP 1PL.EXCL.NOM=TOP FUT~go[AV]  
 ‘We’ll go tomorrow.’

Double *ay*-inversion (p.489)<sup>23</sup>

- b. **Bukas,** kami=*y* mag-pa~pahinga.  
 tomorrow, 1PL.EXCL.NOM=TOP AV-FUT~rest  
 ‘Tomorrow, we’ll rest.’

Prosodic topic + *ay*-inversion (p.494)

## 7.3.4.2 Relative ordering in matrix clauses

*Ay*-inversion can co-occur to a certain extent with other clause-level operations that front constituents to a pre-verbal position. Here again, we find ordering restrictions between these multiple fronted constituents. We first focus on non-DP A'-dependencies, exemplified in (56-57). As an aid to the reader, *ay*-inverted constituents are underlined, while focus constituents are italicized.<sup>24</sup> We see in these examples that with simultaneous focus fronting and *ay*-inversion in matrix clauses, the topic phrase must precede the focus phrase. I take this word ordering restriction as evidence that Tagalog does not have a TopP projection below FocP.

## (55) BASELINE SENTENCES

- a. B<in>ili ni Kiko ang mapa sa gasolinahan.  
 <PFV>buy[PV] GEN.P Kiko NOM map OBL gas.station  
 ‘Kiko bought the map at the gas station.’
- b. I-p<in>ang-anak si Jose Rizal sa Calamba.  
 CV-<PFV>paN-child NOM.P Jose Rizal OBL Calamba  
 ‘Jose Rizal was born in Calamba.’

(56) *Ay*-TOPIC PRECEDES FOCUS PHRASE*Ay* > Foc

- a. {\**Sa gasolinahan*} ang mapa ay {*sa gasolinahan*} b<in>ili ni Kiko.  
 NOM map TOP OBL gas.station <PFV>buy[PV] GEN.P Kiko

(... Ang gatas naman ay sa supermarket.)  
 NOM milk *naman* TOP OBL supermarket

‘As for the map, it was at the gas station that Kiko bought it. (As for the milk, it was at the supermarket.)’

<sup>23</sup>Schachter and Otones note, however, that double *ay*-inversion can be unusual.

<sup>24</sup>Some examples like (56a) can sometimes be rejected by speakers due to their complexity, but presenting them in a larger pair-list context appears to help with acceptance.

- b. {\*Sa Calamba} si Jose Rizal ay {sa Calamba} i-p<in>ang-anak.  
 NOM.P Jose Rizal TOP OBL Calamba CV-<PFV>paN-child

‘As for Jose Rizal, it was in Calamba that he was born.’

(57) *Ay*-TOPIC PRECEDES INTERROGATIVE *wh*-EXPRESSION

*Ay* > *Wh*

- a. {\*Saan} ang mapa ay {<sup>?</sup>saan} b<in>ili ni Kiko?  
 NOM map TOP where <PFV>buy[PV] GEN.P Kiko

‘As for the map, where did Kiko buy it?’

- b. {\*Saan} si Jose Rizal ay {saan} i-p<in>ang-anak?  
 NOM.P Jose Rizal TOP where CV-<PFV>paN-child

‘As for Jose Rizal, where was he was born?’

### 7.3.4.3 Restricted ordering in embedded clauses

Based on the matrix clause data we have seen so far, the hierarchy of projections for the left periphery that we have is shown in (58). With the *kung+wh* constructions however, we find behavior that supports the proposed hierarchy, but with some complications stemming from an adjacency requirement between *kung* and the *wh*-expression. This adjacency requirement prevents *ay*-topics from preceding *wh*-expressions in *kung+wh* constructions, even if the word order is attested in matrix clauses (e.g., with *wh*-questions). As mentioned at the beginning of this subsection, I account for this adjacency requirement as a requirement that left-peripheral projections (i.e., RelP, FocP) with *wh*-expressions in their specifiers must be selected as complement of Force<sup>0</sup> directly, without any intervening projections such as TopP.

(58) PROPOSED HIERARCHY OF PROJECTIONS FOR TAGALOG

$$\begin{array}{ccccccc} \text{ForceP} & > & \text{RelP} & > & \text{TopP}^* & > & \text{FocP} & > & \text{FinP} \\ (kung) & > & (Wh_{\text{Rel}}) & > & (Ay\text{-topic}) & > & (\text{Foc}/Wh_Q/Wh_{\text{Rel}}) & > & \end{array}$$

Looking first at *kung*-RCs, we observe the opposite word order from that of matrix *wh*-questions: an *ay*-inversion topic phrase must *follow* the *wh*-expression, as we can see in (59). This is partially what we expect given the preceding discussion of clitics, particularly given the *wh*-expression’s high Spec-RelP position. What is unexpected, however, is its lack of optionality. That is, given the earlier claim that the relative pronoun may also surface lower in Spec-FocP, we would expect it to be able to appear in either position relative to the *ay*-topic, contrary to what we see below. As we will see, the absence of this word order option for *kung*-RCs reflects a more general restriction that nothing may intervene between *kung* and a *wh*-expression. Thus, I assume that this position is still in principle available to the relative pronoun unless it is occupied by a clear focus phrase, as discussed previously in Section 7.3.3.

(59) *Ay*-TOPIC FOLLOWS *kung*-RC *wh*-EXPRESSION

- a. Malayo ang gasolinahan [kung {saan} ang mapa ay {\*saan} b<in>ili ni Kiko].  
 far NOM gas.station if where NOM map TOP <PFV>buy[PV] GEN.P Kiko

‘The gas station where, the map, Kiko bought (it) is far.’

- b. P<um>unta sila sa bahay [kung {saan} si Jose Rizal ay {\*saan} i-p<in>ang-anak].  
 <AV>go(PFV) 3PL.NOM OBL house if where NOM.P Jose Rizal TOP CV-<PFV>paN-child  
 ‘They went to the house where Jose Rizal was born.’

Free relatives and embedded (non-DP) questions exhibit a similar pattern, as shown in (60-61), although the data is slightly more equivocal. In both constructions, we see that it is still ungrammatical for the *ay*-topic to intervene between *kung* and the *wh*-expression. Moreover, to the extent that *ay*-inversion can occur with these constructions, the *ay*-topic must follow the *wh*-expression, although even this word order is marked or marginal. This markedness seems to vary between speakers, with it being more pronounced with embedded *wh*-questions than with free relatives.

(60) *Ay*-TOPIC MARGINALLY FOLLOWS FREE RELATIVE *wh*-EXPRESSION

- a. [Kung {?saan} ang mapa ay {\*saan} b<in>ili ni Kiko], doon sila pu~punta.  
 if where NOM map TOP <PFV>buy[PV] GEN.P Kiko DIST.OBL 3PL.NOM FUT+go(AV)  
 Intended: ‘Wherever Kiko bought the map, that’s where they’re going.’
- b. [Kung {?saan} si Jose Rizal ay {\*saan} i-p<in>ang-anak], doon naka-tirá si Jenny.  
 if where NOM.P Jose Rizal TOP CV-<PFV>paN-child DIST.OBL STAT-live NOM.P Jenny  
 Intended: ‘Wherever Jose Rizal was born, that’s where Jenny lives.’

(61) *Ay*-TOPIC MARGINALLY FOLLOWS EMBEDDED *wh*-INTERROGATIVE

- a. T<in>anong nila [kung {??saan} ang mapa ay {\*saan} b<in>ili ni Kiko].  
 <PFV>ask[PV] 3PL.GEN if where NOM map TOP <PFV>buy[PV] GEN.P Kiko  
 Intended: ‘They asked, as for the map, where Kiko bought it.’
- b. \*Gusto ko=ng m-alam-an [kung {??saan} si Jose Rizal ay {\*saan} i-p<in>ang-anak].  
 want 1SG.GEN=LK NVOL-know-LV if where NOM.P Jose Rizal TOP CV-<PFV>paN-child  
 Intended: ‘I want to know where Jose Rizal was born.’

#### 7.3.4.4 Accounting for *kung+wh* adjacency

The ordering facts shown above appear problematic for my initial claim that interrogative pronouns occupy Spec-FocP in embedded questions. In particular, compare the behavior of the free relatives and embedded questions with that of the matrix *wh*-questions, where the *ay*-topic must precede the *wh*-expression (cf. 57). Overall then, we see in the preceding data that the *kung+wh* constructions all lack an expected pre-*wh* position for the *ay*-topic, given previous claims about Spec-FocP. I will leave a formal account reconciling this discrepancy for future work, but I maintain that the behavior we see is compatible, if not consistent, with the original claims made so far about the structure of the left periphery and the landing sites of the relevant left-peripheral phrases. The following pieces of evidence support this claim.

First, the difference between (in particular) *kung*-RCs and embedded non-DP questions, where *ay*-inversion is acceptable in the former but marked in the latter, is fairly robust. We can partially understand this contrast under the assumption that *kung*-RCs have a readily available landing site (i.e., Spec-RelP) for

the relative pronoun that c-commands the landing site for the *ay*-topic (i.e., Spec-TopP). In other words, this word order can be readily generated. On the other hand, the reverse word order of embedded non-DP questions when compared to matrix ones can potentially be understood in relation to the next observation.

Second, the inseparability of *kung* and the *wh*-expression is a general property of *kung+wh* expressions, suggesting that there is some additional interaction between these two elements. Crucially, as (62) shows, we see this tight association between *kung* and the *wh*-expression, not only when the *wh*-expression is a non-DP (which I have proposed to occupy positions in the articulated left periphery), but also when it is a DP (i.e., when the complement of *kung* is a pseudocleft). With the matrix clause in (62a), *ay*-topics must precede the focus phrase in a pseudocleft, which in this case is a *wh*-expression. Contrast this with the embedded question in (62b), where the *ay*-topic *may not* precede the *wh*-expression.

(62) ORDERING ASYMMETRIES BETWEEN TOPIC AND *wh* IN DP QUESTIONS

- a. {\**Sino* ang} Sa Calamba ay {<sup>?</sup>*sino* ang} i-p<in>ang-anak?  
 OBL Calamba TOP who NOM CV-<PFV>*paN*-child  
 ‘As for Calamba, who was born there?’
- b. Gusto ko=ng m-alam-an [kung {<sup>??</sup>*sino* ang} sa Calamba ay {\**sino* ang}  
 want 1SG.GEN=LK NVOL-know-LV if who NOM OBL Calamba TOP  
 i-p<in>ang-anak].  
 CV-<PFV>*paN*-child  
 ‘As for Calamba, who was born there?’

The fact that embedded DP questions still show properties of their pseudocleft structure—note in particular the determiner (*ang*) marking the presuppositional statement—is evidence that this structure is attested in at least some stage of the derivation (e.g., before *kung* is merged). I assume that embedded non-DP questions are derived in a parallel way (i.e., having a derivational step where the *wh*-expression occupies Spec-FocP). What, then, causes the adjacency requirement between *kung* and *wh*? I speculate that one way we might capture this behavior is as a syntactic locality requirement between *kung* and any *wh*-expressions in its complement.

If we assume that Force<sup>0</sup> may select different projections along the articulated left periphery as its complement, then we can account for the adjacency effect as a requirement that the *wh*-expression be in the specifier of the complement of *kung*.<sup>25</sup>

Structures for different *kung+wh* constructions are sketched in (63). Relative clauses have a RelP complement, embedded DP questions have an IP complement (with the *wh*-expression in the usual position for non-verbal predicates assumed in this analysis), and embedded non-DP questions (as well as some *kung*-RCs) would have a FocP complement. In the first case, TopP is readily available to host an *ay*-topic. In the other two, however, the TopP projection is excluded from the structure as it occurs above IP and FocP. We might then take the marked *wh*-topic order in embedded *wh*-questions as an effect of coercion, although this idea would need to be fleshed out and formalized, along with the details of the

<sup>25</sup>Alternatively, the disparate environments where this adjacency requirement occurs may be taken as support that a more general principle, such as Contiguity Theory Richards (2016), is at work. See Richards 2020 for discussion of similar adjacency facts involving *wh*-predicates, which are not discussed in this thesis.

local relationship between *kung* and *wh*.

(63) a. *Kung* RELATIVE CLAUSE

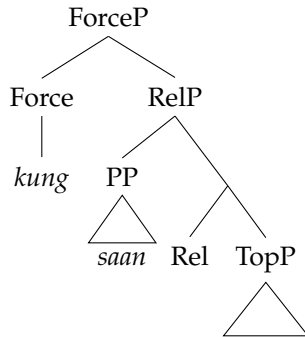

b. EMB. DP QUESTION

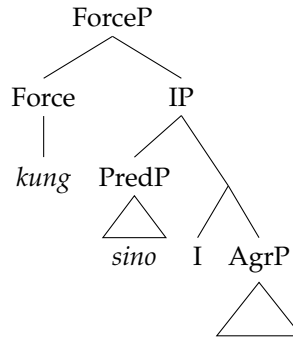

c. EMB. NON-DP QUESTION

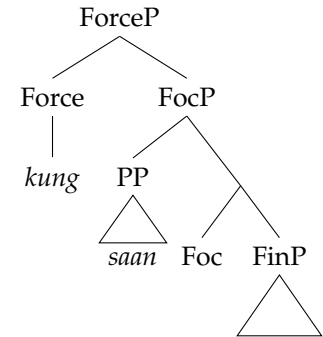

Regardless of the final analysis of this adjacency requirement, we see it obscures the word order facts somewhat by eliminating the pre-*wh* position for *ay*-topics across the board. However, in the other available linear position for the *ay*-topic, we see a pattern that I have argued to be parallel to the facts surrounding clitic placement discussed in the previous subsection. The data presented in this section so far is summarized in Table 7.3. The cells that are highlighted in gray represent the effects of *kung-wh* adjacency.

Table 7.3: Word-order patterns with fronting constructions (*ay*-topics)

|                              | <i>Kung+wh</i>  |           |                 | Mat. <i>WhQ</i> | Position of <i>wh</i> |
|------------------------------|-----------------|-----------|-----------------|-----------------|-----------------------|
|                              | <i>Kung</i> -RC | Free Rel. | Emb. <i>WhQ</i> |                 |                       |
| Post-verbal clitic           | ✓               | ✗         | ✗               | ✗               | High (Spec-RelP)      |
| <i>Wh</i> - <i>Ay</i> -topic | ✓               | ?         | ??              | ✗               |                       |
| Post- <i>wh</i> clitic       | ✓               | ✓         | ✓               | ✓               | Low (Spec-FocP)       |
| <i>Ay</i> -topic- <i>Wh</i>  | ✗               | ✗         | ✗               | ✓               |                       |

### 7.3.5 The high position of *bakit* ‘why’

Further evidence for the existence of a high left-peripheral position, specifically one above TopP comes from the behavior of questions with *bakit* ‘why’, which is strikingly distinct from the other *wh*-interrogatives we have seen thus far. Previous work on the behavior of *why* cross-linguistically has argued that it is introduced structurally high, directly in the left periphery of the clause, owing to its status as a sentential adverb (see for example Rizzi 1990, chap.2.4; Lin 1992; Ko 2005; Stepanov and Tsai 2008; Tsai 2008). Tagalog *bakit* conforms to this generalization, as we will see, and its high position results in behavior that is closer to *kung*-RCs than to other *wh*-questions with respect to the word order diagnostics previously discussed. This high position for *bakit* is reflected in (64).

(64) PROPOSED HIERARCHY OF PROJECTIONS FOR TAGALOG

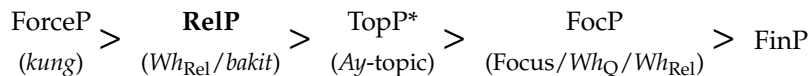



First, we see in (65) that questions with *bakit* ‘why’ take the form of non-DP questions in that the presuppositional statement cannot be marked with a determiner.

- (65) *Bakit* (\*ang) naglu~luto si Kiko ng papaitan?  
 why NOM AV.IMPF~COOK NOM.P Kiko GEN *papaitan*  
 ‘Why is Kiko cooking *papaitan*?’<sup>26</sup>

Despite this surface structural similarity to other non-DP questions, there is strong evidence that *bakit* can occupy not only Spec-FocP, but a higher position as well. First, we see in (66) that, unlike other *wh*-questions, *bakit* questions can co-occur with non-*wh* focus constructions—both focus fronting and pseudoclefts. In particular, the grammaticality of (66a) tells us that *bakit* must not be occupying Spec-FocP in these examples. Note also that *bakit* cannot follow the non-*wh* focus phrase, suggesting that the position the *wh*-expression occupies here is higher than FocP.

- (66) *Bakit* > FOCUS
- a. {*Bakit*} [*sa labas*] {\**bakit*} *sila* nag-lu~luto ng *papaitan*?  
 why OBL outside 3PL.NOM AV.IMPF~COOK GEN *papaitan*  
 ‘Why are they cooking *papaitan* OUTSIDE?’
- b. {*Bakit*} [*si Kiko*] ang {\**bakit*} nag-lu~luto ng *papaitan*?  
 why NOM.P Kiko NOM AV.IMPF~COOK GEN *papaitan*  
 ‘Why is KIKO the one who is cooking *papaitan*?’

The position of *bakit* is not obligatorily high, however. Our second piece of evidence shows us that there is reason to believe that *bakit* may also occupy a lower position in the left periphery. The example in (67) shows us that *bakit* questions, whether matrix or embedded, have two possible cliticization positions: the post-*wh* position and the post-verbal one. Recall that we saw this optionality with *kung*-RCs, but not with focus fronting (whether matrix or embedded) and free relatives, which only had the post-*wh* position available. As with *kung*-RCs, I take the post-verbal position of the clitic to indicate that the *wh*-expression is structurally high (outside of the clitic placement domain), and the post-*wh* position to indicate the opposite.

- (67) CLITICS SHOW FLEXIBILITY WITH *bakit*
- a. *Bakit* {*sila*} naglu~luto {*sila*} ng *papaitan*?  
 why 3PL.NOM AV.IMPF~COOK 3PL.NOM GEN *papaitan*  
 ‘Why are they cooking *papaitan*?’
- b. T<in>a~tanong ni Esther kung *bakit* {*sila*} naglu~luto {*sila*} ng *papaitan*.  
 IMPF~ask[PV] GEN.P Esther if why 3PL.NOM AV.IMPF~COOK 3PL.NOM GEN *papaitan*  
 ‘Esther is asking why they are cooking *papaitan*.’

Third, *ay*-inversion can occur in *bakit* questions as in (68), with the *ay*-topic following the *wh*-expression, again unlike what we find in other *wh*-questions. The other order of topic and *wh*-expression

<sup>26</sup>*Papaitan*, a specialty of the Ilocos region in the north of the Philippines, is an offal stew whose key flavoring agent is bile.

is possible but appears to be less common. In a Google search, the most plausible cases found of this word order appeared to be from creative writing, some of which are shown in (69).

(68) {*Bakit*} si Kiko ay {*bakit*} naglu~luto ng papaitan?

why NOM.P Kiko TOP why AV.IMPF~COOK GEN *papaitan*

'Why is Kiko cooking *papaitan*?'

(69) a. Mukha mo ay *bakit* 'di ko ma-limut-limot pa  
face 2SG.GEN TOP why NEG 1SG.GEN AV-RED-forget still

'Why can't I seem to forget your face still?'<sup>27</sup>

b. Ang mga na-ganap sa aki[n]=ng nakalipas ay *bakit* nangya~yari nanaman ngayon?

NOM PL PFV-OCCUR OBL 1SG.OBL=LK past TOP why IMPF~happen again now

'The things that occurred in my past, why are they happening again now?'<sup>28</sup>

Given the high position available for *bakit*, we also expect *kung+wh* constructions with this *wh*-expression to not be marked when appearing with *ay*-inversion, like other *kung*-RCs but unlike other embedded questions. This expectation is borne out with *kung*-RCs with *bakit*, and importantly also with the corresponding embedded questions.

(70) a. Nakaka-gulat ang dahilan [kung {*bakit*} si Kiko ay {*\*bakit*} naglu~luto ng  
NVOL.IMPF-surprise NOM reason if why NOM.P Kiko TOP AV.IMPF~COOK GEN  
papaitan].

*papaitan*

'The reason [why Kiko is cooking *papaitan*] is surprising.'

b. Hindi namin ma-intindih-an [kung {*bakit*} si Kiko ay {*\*bakit*} naglu~luto ng  
NEG 1PL.EXCL.GEN NVOL-understand-LV if why NOM.P Kiko TOP AV.IMPF~COOK GEN  
papaitan].

*papaitan*

'We don't understand [why Kiko is cooking *papaitan*].'

The word order patterns we see with *bakit* are added to the summary table (Table 7.4) and the left-peripheral hierarchy is repeated in (71). Here, we see that *bakit* behaves identically to *kung*-RCs, except in terms of word order. Moreover, *bakit* questions provide evidence that there is indeed a position in the left periphery that is both above TopP and independent of the adjacency requirement imposed by *kung*. I assume that the low position of *bakit* is Spec-FocP, and, for the purposes of this thesis, that the high one is Spec-RelP. While the identity of this higher position may be conceptually strange, I currently do not have strong evidence to reject the idea that relative pronouns and *bakit* 'why' have access to the same high position.<sup>29</sup> Investigation of this issue is left for future work.

<sup>27</sup>Michael Pangilinan, *Bakit Ba Ikaw*, Manila: ABS-CBN Film Productions, Inc., 2016, <https://open.spotify.com/track/0Vmk6Ebk4QBq7r0VAz2a6s?si=n4zTrBx5TNe9y3mQ-kmE6w>.

<sup>28</sup>Jerick Flores, "Para Sayo," *Boiling Waters PH*, March 12, 2019, <https://boilingwaters.ph/para-sayo-5/>.

<sup>29</sup>In particular, *kung*-RCs cannot co-occur with *wh*-questions, including those with *bakit*. This was mentioned briefly in fn.18.

Table 7.4: Word-order patterns with fronting constructions (*bakit* questions)

|                             | <i>Kung+wh</i> |           |                 | <i>Bakit</i>           | Mat. <i>WhQ</i> | Position of <i>wh</i> |
|-----------------------------|----------------|-----------|-----------------|------------------------|-----------------|-----------------------|
|                             | <i>Kung-RC</i> | Free Rel. | Emb. <i>WhQ</i> |                        |                 |                       |
| Post-verbal clitic          | ✓              | ✗         | ✗               | ✓                      | ✗               | High (Spec-RelP)      |
| <i>Wh-Ay</i> -topic         | ✓              | ?         | ??              | ✓                      | ✗               |                       |
| Post- <i>wh</i> clitic      | ✓              | ✓         | ✓               | ✓                      | ✓               | Low (Spec-FocP)       |
| <i>Ay</i> -topic- <i>Wh</i> | ✗              | ✗         | ✗               | ✓/? (Mat.)<br>✗ (Emb.) | ✓               |                       |

## (71) PROPOSED HIERARCHY OF PROJECTIONS FOR TAGALOG

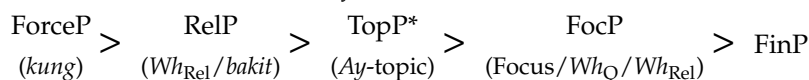

## 7.3.6 Recent Perfective and the Left Periphery

Whereas we saw supporting evidence for the existence of a high left-peripheral position with *bakit* ‘why’, here, we will see supporting evidence for the low position. Specifically, we revisit the fact (initially mentioned in Section 7.1.3) that focus fronting is not possible with the Recent Perfective form. Here, I argue that this restriction is best understood as a missing or defective FocP projection, and that under such a view, we can account for a few other behaviors that surface with the interaction of RPFV and other constructions that utilize the left periphery.

First, recall that focus fronting, which targets non-DPs, is incompatible with the RPFV form, regardless of whether the fronted constituent is interrogative or not.<sup>30</sup> We see this again in (72), which shows examples involving an oblique-marked location. Both of (72b-c) show two placement positions for the clitic cluster *lang niya*. We see that the immediately post-*wh*/focus position that we would expect for focus fronting is unavailable. Instead, speakers marginally prefer the post-verbal position, which we have seen is unavailable for other cases of focus fronting. I argue that we can understand the behavior in (72) under the assumption that the usual Spec-FocP position for the focus phrase is not available in RPFV clauses. Instead, the preferred clitic position suggests that these focus phrases exceptionally occupy a left-peripheral position that is higher than Spec-FocP. In (73), we see similar behavior for embedded questions and free relatives.

## (72) FOCUS FRONTING (TO SPEC-FOCP) AND RECENT PERFECTIVE ARE INCOMPATIBLE

- a. Kaka~bili lang niya ng gatas sa tindahan.

RPFV~buy only 3SG.GEN GEN milk OBL store

‘They<sub>SG</sub> have just bought milk at the store.’

Baseline

- b. Saan {\*lang niya} kaka~bili {?lang niya} ng gatas?

where RPFV~buy only 3SG.GEN GEN milk

Intended: ‘Where have they<sub>SG</sub> just bought milk?’

\*Interrogative

<sup>30</sup>This behavior contrasts with pseudoclefts, which target DPs, which *are* compatible with the RPFV form.

- c. Sa tindahan {\*lang niya} kaka~bili {?lang niya} ng gatas.  
 OBL store RPFV~buy only 3SG.GEN GEN milk

Intended: 'It's at the store that they<sub>SG</sub> have just bought milk.'

\*Declarative

- (73) a. Gusto=ng m-alam-an ni Edwin [kung saan {\*lang niya} kaka~bili {?lang niya} ng  
 want=LK NVOL-know-LV GEN.P Edwin if where RPFV~buy only 3SG.GEN GEN  
 gatas].  
 milk

Intended: 'Edwin wants to know [where they<sub>SG</sub> have just bought milk].'

\*Embedded *wh*-question

- b. [Kung saan {\*lang niya} kaka~bili {?lang niya} ng gatas], doon niya  
 if where RPFV~buy only 3SG.GEN GEN milk DIST.OBL 3SG.GEN  
 na-iwan ang pitaka niya.  
 NVOL.PFV-leave[PV] NOM wallet 3SG.GEN

'[Wherever they<sub>SG</sub> have just bought milk], it's there that they<sub>SG</sub> left their<sub>SG</sub> wallet.'

\*Free Relative

Thus, we see that in RPFV clauses, a high position in the left periphery is available, but the low Spec-FocP position is not. Under this view, constructions that standardly make use of at least some left peripheral positions higher than FocP should be compatible with RPFV. This prediction is borne out. First, *ay*-inversion is compatible with RPFV, as in (74); note the post-verbal position of *lamang*, which is the longer form of *lang*.

(74) *Ay*-INVERSION AND RECENT PERFECTIVE

- Ang mga pasyente ay kai~inom lamang ng gamot.  
 NOM PL patient TOP RPFV~drink only GEN medicine

'As for the patients, they have just taken medicine.'

Second, both *bakit* and *kung*-RCs are also compatible with this clause type, as shown in (75). We see in these examples that clitics may surface post-verbally, a fact that I have previously taken to indicate that the *wh*-expressions occupied Spec-RelP. This clitic placement thus corroborates the existence of positions higher than Spec-FocP previously demonstrated by *ay*-inversion in (74). Significantly, the post-verbal position is the only grammatical position for clitics in this example, contrary to the optionality in clitic placement that we have seen in *bakit* questions and *kung*-RCs. We have previously seen that the post-*wh* clitic position corresponds to the *wh*-expression occupying Spec-FocP, so the non-availability of this clitic position corroborates the original claim made at the beginning of this subsection. Spec-FocP is unavailable in RPFV clauses.

(75) *Bakit* AND *kung*-RCs WITH RECENT PERFECTIVE

- a. *Bakit* {*\*lang nila*} *kalu~luto* {*lang nila*} *ng papaitan?*  
 why RPFV~cook only 3PL.GEN GEN *papaitan*  
 ‘Why have they just cooked *papaitan*?’  
 ‘Why is it that they have just (only now) cooked *papaitan*?’<sup>31</sup>
- b. *Mura lang ang mga bilihan sa tindahan* [*kung saan* {*\*lang niya*} *kabi~bili* {*lang niya*}  
 cheap only NOM PL wares OBL store if where RPFV~buy only 3SG.GEN  
*ng gatas*].  
 GEN milk  
 ‘The wares are cheap at the store [where they<sub>sc</sub> have just bought milk].’

As with the discussion on *ay*-inversion in 7.3.4, I leave a more detailed formal analysis of the RPFV for future work. However, I provide some speculation here. In previous work (Hsieh 2020), I proposed to tie the lack of the Spec-FocP position to the reduced nature of RPFV, which, as I have previously argued in this thesis, is evidenced by the lack of voice morphology and of a pivot argument (see Section 3.1). In the analysis sketched out, I proposed that FocP and FinP should be collapsed into a single projection in Tagalog, which I labelled FP, and that one of the ways that the reduced nature of RPFV manifests is a reduced FP projection. While some other results were derived by the collapsing of FocP and FinP into FP, such as the lack of a post-focus *ay*-inversion position (recall (56-57) in Section 7.3.4), this may ultimately have been stipulative. Particularly, we would need additional evidence regarding the nature of FinP in Tagalog to show that it is intrinsically tied to FocP in the manner proposed.<sup>32</sup>

Table 7.5 updates our summary table with the data we have seen so far. We see that despite the common *kung+wh* signature, there is consistent evidence that *kung*-RCs are structurally different from the other *kung+wh* constructions, having instead more similarity to a certain type of *wh*-question, those with *bakit* ‘why’. Both *kung*-RCs and *bakit* questions show optionality between a high and low left-peripheral position. We see that this high position, which I propose is Spec-RelP, is normally only available to relative pronouns and *bakit*, whereas the low position is also accessible to *wh*-questions and free relatives. On the basis of co-occurrence restrictions with non-interrogative focus fronting, I proposed that this low position is Spec-FocP. This proposal is also consistent with previous work showing a structural parallel between non-interrogative focus fronting and non-DP *wh*-questions (Aldridge 2002; Mercado 2004).

<sup>31</sup>At least one speaker I have worked with reports that questions of this form have a very specific meaning, in that they do not ask about the reason for the action, but rather the reason that the action was completed only recently. I provide the second free translation in (75a) in an effort to convey this meaning. The fact that this reading exists may be informative for our understanding of RPFV, but I leave this issue for future work.

<sup>32</sup>One other way in which RPFV can be said to be reduced is that it cannot be negated, as (i) shows. However, it is not clear that this effect is necessarily syntactic in nature. For example, given the very specific semantic denotation of the RPFV form, negation might result in the utterance somehow being maximally uninformative. Given this, it is interesting to note that negation is also ill-formed with a number of exclamative adjectival forms, as in (ii), which, like RPFV, lack *ang*-marking.

(i)\*Hindi {*lang niya*} *kabi~bili* {*lang niya*} *ng gatas*. (ii)\*Hindi *napaka-liit ng Canada!*  
 NEG only 3SG.GEN RPFV~buy GEN milk NEG very-small GEN Canada  
 Intended: ‘They<sub>sc</sub> haven’t just bought milk.’ Intended: ‘It’s not the case that Canada is very small!’

Table 7.5: Word-order patterns with fronting constructions

|                             | <i>Kung+wh</i> |           |                 | <i>Bakit</i>           | Mat. <i>WhQ</i> | Position of <i>wh</i> |
|-----------------------------|----------------|-----------|-----------------|------------------------|-----------------|-----------------------|
|                             | <i>Kung-RC</i> | Free Rel. | Emb. <i>WhQ</i> |                        |                 |                       |
| Post-verbal clitic          | ✓              | ✗         | ✗               | ✓                      | ✗               | High (Spec-RelP)      |
| <i>Wh-Ay</i> -topic         | ✓              | ?         | ??              | ✓                      | ✗               |                       |
| Recent Perfective           | ✓              | ? (V=Cl)  | ? (V=Cl)        | ✓                      | ? (V=Cl)        |                       |
| Post- <i>wh</i> clitic      | ✓              | ✓         | ✓               | ✓                      | ✓               | Low (Spec-FocP)       |
| <i>Ay</i> -topic- <i>Wh</i> | ✗              | ✗         | ✗               | ✓/? (Mat.)<br>✗ (Emb.) | ✓               |                       |

## 7.4 Non-DP movement and DP non-movement

Having presented the analyses for both DP- and non-DP-targeted  $A'$ -dependencies, this section discusses how the various components of these analyses interact to produce the overall patterns we see in Tagalog, synthesizing various points which have been previously mentioned or discussed throughout this thesis. I focus in particular on describing in detail the nature of the interaction between the proposed Case licensing system and general  $A'$ -movement, as well as comparing side-by-side the two mechanisms proposed to form  $A'$ -dependencies in this language,  $A'$ -movement and binding of *pro*. I also discuss some implications of this mixed movement/non-movement analysis for the *ay*-inversion construction and provide some speculation towards an analysis.

### 7.4.1 On movement, Case, and the DP/non-DP split

As previously discussed (particularly in Sec. 5.2), a proposed interaction between Case licensing and movement lies at the heart of the structural split between the constructions used for DP- and non-DP-targeted  $A'$ -dependencies. That is, this interaction causes DPs to be incompatible with conventional  $A'$ -movement, as such movement is to positions where abstract Case is not typically assigned. Here, I recap the details of these interactions and their effects, now that the remainder of the analysis has been proposed in this chapter.

I assume that positions in the left periphery mostly come to be occupied via movement from a base position below FinP, with certain cases resulting from high base-generation (e.g., *bakit* ‘why’; see Section 7.3.5). I also follow the standard minimalist assumption that movement is triggered by a probe on a syntactic head searching for a c-commanded goal with the correct feature specification. For example, when questioning a locative argument, the [ $u$ FOC] feature on  $Foc^0$  triggers movement of *saan* ‘where’, which is base-generated as the complement of  $V^0$  (*lagay* ‘put’) and bears a [FOC] feature, as shown in (76).

- (76) a. Saan i-ni-lagay ng abogado ang mga papeles?  
 where CV-PFV-put GEN lawyer NOM PL documents  
 ‘Where did the lawyer put the documents?’

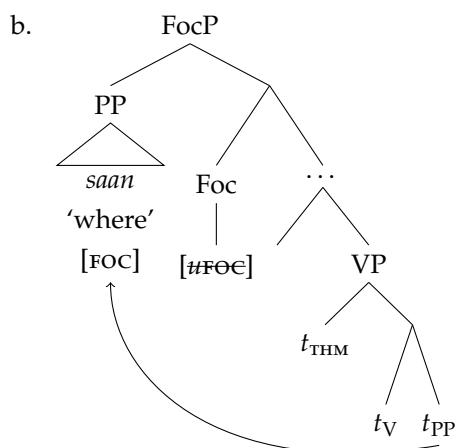

I assume that other *wh*-interrogatives, particularly the DPs *sino* ‘who’ and *ano* ‘what’, as well as non-interrogative focus phrases also bear this [FOC] feature. This would predict that movement to Spec-FocP as illustrated in (76) should be possible, even for DPs, contrary to what is attested. However, recall the extension proposed in Chapter 5 to Béjar and Massam’s (1999) analysis for Multiple Case Checking. Their original analysis proposes that in some languages, Case assigned to a DP is only interpretable when that DP is in a local syntactic configuration with the head assigning that Case. Thus, (A-)movement from one Case position to another is allowed in some languages, but results in only the higher value of Case being spelled out. Béjar and Massam stipulate that this Case locality requirement is inoperative with A’-movement, to account for the fact that A’-movement in the languages they study behaves cross-linguistically typically with respect to Case. In Chapter 5, I argued that this stipulation about A’-movement should be instead cast as a point of cross-linguistic variation, and that Tagalog is a language where the Case locality requirement is operative with *all* types of movement, including A’-movement. That is, in Tagalog, DPs may only move to positions where Case is assigned, while other types of XPs, which do not require Case licensing, can undergo movement more freely.

Coupled with the assumption that no abstract Case is available in the left-peripheral projections involved in A’-movement, the Case licensing system proposed here for Tagalog allows us to account for the differences in structures used to target DPs and non-DPs for A’-dependencies. For example, we rule out the possibility of DP focus fronting because Spec-FocP is not a Case position. In principle, the [*u*FOC] feature on Foc<sup>0</sup> can attract a c-commanded DP bearing [FOC], as it would in the PP scenario sketched in (76). However, since Foc<sup>0</sup> does not assign Case, any DP moving to its specifier is left without licensing, causing the derivation to crash (see also Section 5.2). This situation is sketched in (77). The incompatibility of DPs with Spec-FocP thus explains why an alternative periphrastic strategy is required of DP focus constructions.

- (77) a. \*Ano i-ni-lagay ng abogado sa folder?  
 what CV-PFV-put GEN lawyer OBL folder  
 Intended: ‘What did the lawyer put in the folder?’

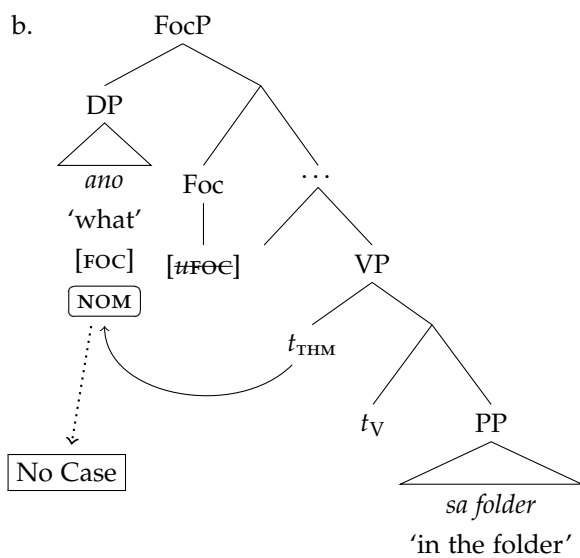

The same reasoning can be extended to relative clauses as well. We can explain the inability of *kung*-RCs to target DP positions, as shown in (78), as a result of Spec-RelP not being a Case position. Movement of a DP to this position is thus ruled out as such a DP would end the derivation without Case, again causing a crash. Following this, we have an explanation for why DP relativization cannot take the form of a *kung*-RC.<sup>33</sup>

- (78) a. sofa kung [saan] natu~tulog ang pusa  
       sofa if       where IMPF~sleep NOM cat  
       ‘sofa where the cat is sleeping’
- b. \*pusa kung [ano] natu~tulog sa sofa  
       cat if       what IMPF~sleep OBL sofa  
       Intended: ‘cat that is sleeping on the sofa’

Turning to non-DPs, their incompatibility with linker RCs straightforwardly follows from the category of the null pronoun *pro*. As this pronoun is a DP, it cannot appear in positions corresponding to non-DPs due to selectional constraints, resulting in the impossibility of examples like (79).

- (79) \*sofa=ng [natu~tulog ang pusa *pro*]  
       sofa=LK IMPF~sleep NOM cat  
       Intended: ‘sofa that the cat is sleeping (on)’

The incompatibility of non-DPs with pseudoclefts that are surface-parallel to those that we observe with DPs, such as (80a), can thus be understood to stem partially from their incompatibility with linker RCs. The other factor explaining the incompatibility of non-DPs with pseudoclefts, is the distinctive behavior of non-DPs when used as predicates (particularly in Sec. 4.2.2) As we saw at the end of Section 5.2, that these issues can be resolved, in some sense. Using a *kung*-RC in place of a linker RC and having a clause-initial predicate DP instead of a PP results in a grammatical construction, as (80b) shows.

<sup>33</sup>That we also excluded periphrastically derived *kung*-RCs in Sec. 7.3 is important, as this rules out a slightly different kind of potential DP-targeting *kung*-RC that has pseudocleft-like structure as the complement of *kung*, exemplified in (i).

(i) \*pusa kung [ano] *ang* natu~tulog sa sofa  
       cat if       what NOM IMPF~sleep OBL sofa  
       Intended: ‘cat that is sleeping on the sofa’



- (80) a. \*{Ang/Sa } paborito ko=ng sofa ang [sofa=ng natu~tulog ang pusa *pro*]  
 NOM OBL favorite 1SG.GEN=LK sofa NOM sofa=LK IMPF~sleep NOM cat

Intended: ‘The sofa that the cat is sleeping (on) is my favorite sofa.’

- b. Ang paborito ko=ng sofa ang [sofa kung saan natu~tulog ang pusa]  
 NOM favorite 1SG.GEN=LK sofa NOM sofa if where IMPF~sleep NOM cat

‘The sofa where the cat is sleeping is my favorite sofa.’

### 7.4.2 On locality

Given the incompatibility of DPs and  $A'$ -movement discussed in the previous subsection, I proposed an alternative mechanism for forming DP-targeted  $A'$ -dependencies. Instead of relying on  $A'$ -movement, I proposed that this alternative mechanism involves a null pronoun *pro* that is bound by an operator introduced at the clause edge. Furthermore, I argued that the binding of *pro* by the operator is subject to a locality requirement. Importantly, the kind of locality exhibited by the *pro* mechanism is different from that exhibited by  $A'$ -movement, as discussed in Section 7.1, supporting the idea that two distinct processes are involved. Here, let us consider in more detail the patterns of locality of these two mechanisms.

In Chapters 5–6, I argued that the observed distribution of DP-targeted  $A'$ -dependencies is accounted for by positing a locality requirement on the binding relationship between *pro* and the operator that can be satisfied in a number of ways. In environments where inflectional structure (e.g., AgrP, IP, NumP) intervenes between *pro* and the clause-edge operator, it was proposed that *pro* must undergo some independently available movement operation to escape the thematic domain (i.e., *vP*, *nP*, *aP*). We saw two options for such an operation: pivot movement to Spec-AgrP (introduced in Sec. 5.3), and genitive inversion to a higher position which I provisionally called Spec-InvP (introduced in Sec. 6.3). On the other hand, in environments where this inflectional structure is absent, specifically Recent Perfective clauses and *kay/napaka*-exclamatives (Sec. 6.5), it was proposed that *pro* may be bound in-situ (i.e., without escaping the thematic domain).

In contrast to the relative inaccessibility of the thematic domain for the *pro*-binding mechanism, we saw in Section 7.1 that  $A'$ -movement in Tagalog could straightforwardly target material within *vP*. In particular,  $A'$ -dependencies can be formed over internal arguments such as (non-DP) goal arguments (via  $A'$ -movement), but not over (non-pivot) themes, even though they are also internal arguments.

Looking higher in the structure, we have also seen difference with regards to the CP and DP phases. Specifically, I argued that  $A'$ -movement could *not* escape these phases, deriving the inability of non-DPs to undergo long-distance  $A'$ -movement out of embedded clauses (Sec. 5.6) and out of DPs (Sec. 6.4.5). Such a pattern thus contrasts with what we saw with the *pro* mechanism. In this case, we saw that *pro* could be bound within a DP if it appeared in a sufficiently high position, resulting in subextraction dependencies (Sec. 6.4). On the other hand, I proposed that binding across a CP boundary was impossible, but that a mechanism of semantic type mismatch and repair effectively allows long-distance DP dependencies to be formed with *pro* (Sec. 5.4)

From these differences, I draw the same conclusion that was motivated by the structural differences

between pseudoclefts and focus fronting discussed in Chapter 4 and formalized in Section 5.2: that A'-dependencies targeting DPs and non-DPs make use of formally distinct processes for their formation. In this thesis, I have formalized this distinction as being between conventional A'-movement and a non-(A'-)movement mechanism involving *pro*.<sup>34</sup>

### 7.4.3 An *ay*-inversion puzzle

So far, I have drawn from a broad range of A'-dependency data in Tagalog to argue that DPs and non-DPs in this language undergo different processes to form A'-dependency constructions that are structurally different from each other. The necessity of these different processes is in turn motivated by the proposed Case licensing system, under which DPs that undergo A'-movement to left-peripheral positions are not licensed because such positions lack abstract Case. Given this background, two Tagalog topicalization constructions not closely considered in this thesis present something of a puzzle, as it is a construction that makes use of a (presumably Caseless) left-peripheral position, but shows no distinction in structure between DP-targeted and non-DP-targeted versions. In this section, I describe the puzzle and speculate a little on a possible solution.

Two types of topicalization in Tagalog do not distinguish structurally between DP and non-DP targets: *ay*-inversion, which we have seen, and prosodic inversion, which uses comma intonation instead of an overt particle to mark the fronted topic. These two have similar distributions, so I focus on *ay*-inversion.<sup>35</sup> As we have seen, *ay*-inversion can front both DPs and non-DPs. The examples below show fronting/topicalization of a pivot agent DP and an oblique locative.

- (81) a. Si Rosa ay nag-dala ng lapis sa sinehan.  
 NOM.P Rosa TOP AV.PFV-bring GEN pencil OBL movie.theater  
 'As for Rosa, she brought a pencil to the movie theater.'
- b. Sa sinehan ay nag-dala si Rosa ng lapis.  
 OBL movie.theater TOP AV.PFV-bring NOM.P Rosa GEN pencil  
 'As for the movie theater, Rosa brought a pencil there.'

Following the discussion in Section 7.3, we assume that the fronted constituent occupies Spec-TopP. Because TopP is in the clausal left periphery, we expect its specifier to lack abstract Case, as has been proposed for Spec-FocP and Spec-RelP. While this lack of Case is consistent with the grammaticality of the oblique topicalization example (81b), it is at odds with the DP topicalization example (81a). If Spec-TopP is occupied by movement from a lower base position (as I have proposed for Spec-FocP and Spec-RelP), then we should predict (81a) to be ungrammatical, contrary to fact.

How do we account for this discrepancy? I speculate that Spec-TopP may come to be occupied either by movement (of a non-DP) or by high base generation (of a DP or a non-DP) and that these two possibilities correlate to the type of complement Top<sup>0</sup> selects. In the former case, the complement of Top<sup>0</sup>

<sup>34</sup>In principle, the conclusion should also be compatible with an approach that accounts for both types of dependencies (purely) through movement of different kinds, so long as the distinguishing locality patterns can be derived.

<sup>35</sup>Although these two kinds of topics have a restricted relative order whereby prosodic topics must precede *ay*-topics. See, for example, Kroeger 1993, p.127.

is the expected left-peripheral projection (FocP or FinP), while in the latter, it is something else, such as a linker RC modifier. Under such an approach, the derivation of non-DP *ay*-inversion examples like (81b) is parallel to what was spelled out for focus fronting and *kung*-RCs in Section 7.4.1. However, the derivation of DP-targeted examples like (81a) require further discussion.

The first observation to make regarding *ay*-inversion of DPs is that this process displays a distribution of valid targets that is similar to the other DP-targeted A'-dependencies, discussed in Chapters 5–6. For example, *ay*-inversion of pivots is well-formed, as we saw with (81a). More interestingly, *ay*-inversion also targets the same range of non-pivot positions. (82) shows a marginal case of genitive agent *ay*-inversion and a crucially ungrammatical case of genitive theme *ay*-inversion (pivots underlined). Similarly, (83) shows an example of subextraction *ay*-inversion, while in (84), we see examples of free-dependency-like *ay*-inversion. Note in particular that (84b) shows that *ay*-inversion is also ungrammatical out of *ang*-exclamatives.

(82) GENITIVE AGENT (BUT NOT GENITIVE THEME) *ay*-INVERSION IS POSSIBLE

a. ?? Ang kapatid ko ay hindi mabu~buhat nang mag-isa ang kaho[n]=ng iyon.  
 NOM sibling 1SG.GEN TOP NEG NVOL.FUT~lift ADV alone NOM box=LK DIST

‘As for my sibling, they<sub>sc</sub> cannot lift that box alone.’

b. \*Ang lapis ay hindi nag-dala si Rosa.  
 NOM pencil TOP NEG AV.PFV-bring NOM.P Rosa

Intended: ‘As for the pencil, Rosa didn’t bring it.’

(83) SUBEXTRACTION *ay*-INVERSION

Ang kalabaw ay p<in>utol ng magsasaká [ang sungay].  
 NOM water.buffalo TOP <PFV>cut[PV] GEN farmer NOM horn

‘As for the water buffalo, the farmer cut off the its horn.’ (modified from Kroeger 1993)<sup>36</sup>

(84) FREE-DEPENDENCY-LIKE *ay*-INVERSION

a. Ang pera ay kabi~bigay ko lang sa iyo.  
 NOM money TOP RPFV~give 1SG.GEN only OBL 2SG.OBL

‘As for the money, I have just given it to you.’

b. Si Wendy ay {\*ang/kay<sup>38</sup>/napaka-} buti.  
 NOM.P Wendy TOP ang kay very- kind

‘As for Wendy, she is very kind.’

This parallel behavior with DP relativization and focus constructions suggests that the post-*ay* portion of the construction is generated with the *pro*-based mechanism—making it formally a linker RC modifier—and that the result serves as the complement of Top<sup>0</sup>. Subsequently, the *ay*-topic DP would be

<sup>36</sup>Kroeger’s original example involved prosodic inversion instead of *ay*-inversion.

<sup>38</sup>Due to its perceived poetic register, the use of *kay* in *ay*-inversion contexts may be judged as unnatural in casual speech.

introduced into the structure by high base generation instead of by movement.<sup>39</sup> We can ask two questions about this proposal. First, how is a DP able to occupy the Caseless position Spec-TopP by base generation but not by movement from a thematic position? Second, what other evidence is there that Top<sup>0</sup> can select other types of constructions, in the way described above? I speculate on some answers here.

For the first question, we might propose that DPs differ in their licensing requirements depending on how they are introduced into a structure. The operating assumption so far has been that DPs require Case licensing, and that this requirement is ultimately responsible for the inability of DPs to move to left-peripheral positions (Sec. 7.4.1). However, such a requirement appears to only hold of DPs that originate within the thematic domain.<sup>40</sup> In particular, in contexts such as appositives, we can have DPs which have no clear source of abstract Case (and therefore of Case licensing). As we see in (85), the appositive must bear nominative morphology *despite* the host DP (in both examples) being assigned abstract genitive Case as a possessor and an agent, respectively. Since we cannot straightforwardly say that the appositive inherits abstract Case from its host DP, we may assume that it bears *no* abstract Case value and that the observed nominative marking is a morphological default (recall Sec. 2.4.1). The idea would then be that DP *ay*-topics are parallel to appositives in being licensed despite lacking abstract Case and in bearing default morphological nominative.

## (85) PROPER NAME APPOSITIVE

- a. Ito ang paborito=ng sapatos [ng kapatid ko=ng [[si /\*ni } Patrick]].  
 PROX(NOM) NOM favorite=LK shoe GEN sibling 1SG.GEN=LK NOM.P GEN.P Patrick  
 ‘These are [my brother Patrick]’s’ favorite shoes’
- b. I-p<in>angako ito [ng puno=ng ministro ng Canada na [[si /\*ni } Justin  
 CV-<PFV>promise PROX(NOM) GEN chief=LK minister GEN Canada LK NOM.P GEN.P Justin  
 Trudeau]].  
 Trudeau  
 ‘This was promised by [the prime minister of Canada Justin Trudeau].’

For the second question, the answer is slightly more speculative. If we consider the broader range of possible *ay*-inversion constructions, we find other behavior that does not neatly conform to the A'-movement based approach posited for *ay*-inversion of non-DPs. These might therefore be derived using the base-generation alternative formulated above, although the question of how this might be done is left for future research. We find at least two examples of the behavior just described, which are pointed out by Schachter and Otnes (1972, pp.487–92).

First, there are cases where the expected non-inversion counterpart of an *ay*-inversion construction does not exist, as we see in (86). From previous examples, we would expect to be able to undo the inversion in (86a) to get something like (86b), but we see that such an attempt is ungrammatical. Consequently, we

<sup>39</sup>Alternatively, we might interpret these parallels as evidence that there is in fact a shared underlying mechanism for deriving A'-dependencies of DPs and non-DPs, which is apparent in *ay*-inversion but somehow obscured with the others. I set this possibility aside for now, as we will see below that *ay*-inversion has its own quirky behavior that could be difficult to explain under this alternative approach.

<sup>40</sup>Such a domain perhaps includes PredP, following the derivation of pseudoclefts (particularly their word order restriction) discussed in Sec. 5.2.1.

must find some way to derive (86a) from a different base structure, say (86c), or else find a way to generate structures like (86b) that are somehow required to undergo *ay*-inversion.

(86) *Ay*-INVERSION WITH NO NON-INVERSION COUNTERPART (Schachter and Otones 1972, p.487)

- a. [Ang na-rinig ko]=’y [da~rating siya búkas].  
 NOM NVOL.PFV-hear[PV] 1SG.GEN=TOP FUT~arrive 3SG.NOM tomorrow  
 ‘What I heard is that he’s coming tomorrow.’ *Ay*-inversion
- b. \*[Da~rating siya búkas] [ang na-rinig ko].  
 FUT~arrive 3SG.NOM tomorrow NOM NVOL.PFV-hear[PV] 1SG.GEN  
 Intended: ‘What I heard is that he’s coming tomorrow.’ Non-existent “baseline”
- c. Na-rinig ko na [da~rating siya búkas].  
 NVOL.PFV-hear[PV] 1SG.GEN LK FUT~arrive 3SG.NOM tomorrow  
 ‘I heard that he’s coming tomorrow.’ Alternative “baseline” [HH]

Second, we find cases where *ay*-inversion can target a position that is otherwise unavailable, *if* the *ay*-topic is an indefinite of some kind (see also Kroeger 1993, pp.67–8). Compare the examples in (82) to their minimally different counterparts in (87). Here, the effect is clearly driven by semantic factors, as evidenced by the presence of the scalar particles *ni* and *kahit*, however, it remains to be determined how these semantic factors interact with *ay*-inversion. There is also the question of what the syntax of these particles is, which has implications for the category of the *ay*-topic as a whole.

(87) WELL-FORMED NON-PIVOT *ay*-INVERSION (Schachter and Otones 1972, pp.490–1, modified)

- a. Ni<sup>42</sup> lapis ay hindi nag-dala si Rosa.  
 even pencil TOP NEG AV.PFV-bring NOM.P Rosa  
 ‘Even a pencil, Rosa didn’t bring.’
- b. Kahit si Superman ay hindi mabu~buhat nang mag-isa ang kaho[n]=ng iyon.  
 even NOM.P Superman TOP NEG NVOL.FUT~lift ADV alone NOM box=LK DIST  
 ‘Even Superman can’t lift that box.’

Given these observations, more research is needed before a concrete account of topicalization (i.e., *ay*-inversion and prosodic inversion) can be proposed. However, I hope to have shown that these topicalization constructions are more complex than they initially seem, and therefore that the surface parallelism between the basic DP and non-DP inversion cases (contrary to what we have seen with other A'-dependencies) may yet be explained by different underlying mechanisms.

## 7.5 Conclusion

In this chapter, I proposed an analysis for non-DP A'-dependencies in Tagalog that is distinct from the system proposed in Chapters 5–6 for DP A'-dependencies. The necessity of this distinct system was

<sup>42</sup>Note that this *ni* is distinct from the personal genitive marker, and is likely a borrowing from Spanish.

motivated by evidence that the constructions used for non-DP A'-dependencies are intrinsically tied to the non-DP-hood of their targets, rather than other factors such as structural position. Further support for this distinction came from the different locality patterns exhibited by the different formation strategies with respect to phase(-like) domains such as  $vP$ , CP, and DP.

The analysis itself is fairly standard from a cross-linguistic perspective, with constituents moving from base positions to a number of possible left-peripheral positions whose existence and relative hierarchical structure were motivated using word order and co-occurrence behavior. Crucially, I proposed that DPs are prevented from forming A'-dependencies in this way because of a fundamental incompatibility. That is, I proposed that syntactic positions non-DP A'-dependency formation are positions where no Case is assigned. This lack of Case precludes DPs from moving to these positions, following the Case licensing system proposed in Chapters 3 and 5.

One final loose end concerns the issue of movement diagnostics such as island and crossover effects. Aside from a section or two in the thesis (e.g., Sec. 4.2.5), I mostly do not discuss such phenomena. This is partially because the interpretation of such phenomena in Tagalog is confounded by other details of the language. For example, the Matrix Verb Constraint discussed in Section 5.4 may be thought of as a kind of island effect that is induced by the voice system. Nevertheless, I proposed an account for it using the *pro*-binding mechanism and the locality constraint specific to it. This perhaps highlights the need to more concretely formalize aspects of the thesis such as the observed locality constraint, before we can ascertain, in a principled way, what is and is not predicted with respect to these classical tests.

## Chapter 8

# Conclusion

In this thesis, I proposed an analysis for various aspects of Tagalog clause structure through the lens of A'-dependencies. While this path is well-trodden in the research on Tagalog, the contribution of this thesis was to bring to bear a wider range of A'-dependency data than had previously been typical. Specifically, I considered data that does not conform straightforwardly to the well-established pivot-only restriction on A'-dependency formation in this language. As we have seen, such data is by no means unknown, but it has often not been taken into account in existing analyses of Tagalog phrase structure, especially not in a way that reflects the broad range of attested behaviors. I showed that seriously considering this data and its analysis is in fact crucial to our understanding of Tagalog clause structure and A'-dependencies in general, especially because of the degree of disagreement that still exists among scholars on these topics.

A major point I argued for in this thesis is that Case and Case licensing in Tagalog is unlike what we might expect from other (particularly non-Austronesian) languages. This different system of Case has ramifications not only for the argument marking patterns in this language, but also more generally for the kinds of operations that DPs in general may undergo. The central guiding idea in formulating this analysis was that DPs in Tagalog have restricted movement possibilities compared to non-DPs. This idea was motivated by a structural difference observed between two types of *wh*-questions/focus constructions: those of DPs, which are more well-studied; and those of non-DPs, which fall within the broadened range of data considered in this thesis. The structural difference is illustrated in (1-2), where we can see a difference in clitic placement (here the pronoun *nila*) and in the obligatory presence or absence of the determiner *ang*.

- (1) {Ano /Ang bago=ng kanta ni Celine Dion} **\*(ang)** tu~tugtug-in **nila** sa party.  
what[NOM] NOM new=LK song GEN.P Celine Dion NOM FUT~play-PV 3PL.GEN OBL party  
'[The one they are going to play at the party] is [what]?'  
'[The one they are going to play at the party] is [Celine Dion's new song].'Pseudocleft
- (2) {Saan /Sa party} **nila** **\*(ang)** tu~tugtug-in ang bago=ng kanta.  
where OBL party 3PL.GEN NOM FUT~play-PV NOM new=LK song  
'Where are they going to play the new song?'  
'It's at the party that they're going to play the new song.'Focus fronting

I argued in favor of an existing view of *wh*/focus of DPs as pseudoclefts. They are DP-DP copular clauses with the *wh*/focus constituent appearing as the (clause-initial) syntactic predicate, and the presuppositional statement expressed as a (headless) relative clause in the syntactic subject position, as illustrated in the free translations in (1). This structure represents a periphrastic strategy for *wh*/focus, and when compared with the focus fronting strategy of non-DP *wh*/focus, a natural question arose. Why must DP *wh*/focus resort to a periphrastic pseudocleft construction instead of simply moving to a designated focus position in the clausal left periphery as with focus fronting? The answer I put forward for this question was the guiding idea of this thesis: that DPs in Tagalog have restricted movement capabilities. I proposed that this restriction should be tied to Case in a way that naturally extends from the behavior of Case elsewhere in this language.

## 8.1 On Case in Tagalog

Independently of *A'*-dependencies, I investigated the dependent marking patterns of Tagalog and described in Section 2.4 a consistent correlation between thematic role of an argument or adjunct and the morphological marking it receives when it is not the pivot of a clause. Thus, I proposed that these underlying patterns were reflective of a system of inherent Case assignment, so that agents and themes always receive genitive Case in their base positions, while the arguments and adjuncts that are marked oblique are formally PPs, which do not require Case.

Within this system of Case assignment, the initially attractive treatment of pivot marking would have been as some other kind of marker distinct from Case. This treatment would have straightforwardly explained its seemingly independent behavior from the rest of the dependent marking system. Nevertheless, I proposed in Chapter 3 that pivot marking should also be formally treated as (nominative) Case, assigned by a proposed functional head  $\text{Agr}^0$  that spells out Tagalog voice morphology. To resolve the apparent incompatibility of this approach with the rest of the proposed Case system, I adopted Béjar and Massam's (1999) Multiple Case Checking analysis of phenomena in various languages where a single DP undergoes movement from one Case-assigned position to another. Under their proposal, Case on a DP is only interpretable when that DP is in a local configuration with the syntactic head that assigns that Case. Movement of a DP from one Case position to another thus causes the Case value assigned in the lower position to be effectively left behind. In Tagalog then, genitive Case is assigned in a base position, while nominative Case is assigned in Spec-AgrP.

In support of this view of Case licensing, I discussed the behavior of the peripheral voice forms like (3), which have pivots associated with non-core thematic roles such as goals, locations, and instruments. Previous work (Rackowski 2002) has argued that these peripheral voice clauses introduce the relevant non-core argument via an applicative projection, so that clauses where such arguments appear as pivots in fact have different derivational starting points from clauses where the same or similar arguments appear as (usually oblique-marked) non-DPs. While I adopted this view of Tagalog peripheral voice forms, I noted one significant problem of such an approach.



- (3) Bi~bigy-an ko      ng regalo ang pinsan ko.  
 FUT~give-LV 1SG.GEN GEN gift      NOM cousin 1SG.GEN  
 ‘I’m going to give my cousin a gift.’

Assuming the general existence of applicative heads in Tagalog that introduce goals, locations, and the like as DP applied objects, a question arises of why such applied objects must always appear as pivots in this language. In other words, applicative structures are somehow only licit with the associated peripheral voice form (i.e., a specific spell-out of Agr<sup>0</sup>), and cannot appear in other environments, shown in (4), such as with other voice forms (where another argument is the pivot) or in pivot-less constructions (e.g., recent perfective, gerunds, etc.).

- (4) a. \*Magbi~bigay ako      ng regalo **ng pinsan ko**.  
 AV.FUT~give 1SG.NOM GEN gift      GEN cousin 1SG.GEN  
 Intended: ‘I will give my cousin a gift.’
- b. \*Na-gulat sila      sa pagbi~bigay ko      ng regalo **ng pinsan ko**.  
 PFV-surprise 3PL.NOM OBL pag.RED~give 1SG.GEN GEN gift      GEN cousin 1SG.GEN  
 Intended: ‘They were surprised by my giving my cousin a gift.’

I showed, however, that the narrow distribution of applicatives can be accounted for as a problem of Case licensing. Specifically, the reason why applied objects must appear as pivots is because pivot marking (i.e., nominative Case) is the only available source of Case licensing for that argument. If another argument receives this marking, or if the clause has no source of pivot marking, then the applied argument remains unlicensed, causing the derivation to crash. Under the alternative view, where pivot marking is *not* Case, we saw that accounting for this problem was less straightforward.

As a whole, the proposal I put forth for Case licensing in Tagalog makes this language appear unusual from the perspective of more well-studied languages. We saw, however, that this result was not so surprising, as Tagalog has long been established as an unusual language with respect to issues surrounding case alignment and related phenomena. For example, there remains no definitive consensus as to the identity of the basic transitive clause type in this language, even with existing work making use of data from a diverse set of methodologies ranging from morphological arguments to frequency in naturalistic corpora (Maclachlan 1996, §2.4). In a similar vein, this result was also unsurprising in the broader context of the Austronesian languages, which share various aspects of their behavior with Tagalog.

## 8.2 On non-movement in Tagalog

One benefit of the Case licensing system proposed in this thesis for Tagalog is that it extends naturally to formalize the guiding idea stated at the outset of this chapter that DPs have restricted movement capabilities when compared to non-DPs. Case is well-suited to capture this distinction, as it is intrinsically associated with DPs through licensing, but not with non-DPs like PPs, which standardly do not require licensing.

In Section 5.2, I proposed to derive the movement restriction of DPs in this language by extending the multiple Case checking analysis of Béjar and Massam (1999). Their original proposal stipulates that the locality requirement on the interpretation of Case only holds under A-movement, to account for the preservation of Case under A'-movement in the languages they discuss. I proposed that in Tagalog, this stipulation is not warranted, such that the interpretability of Case is *generally* interrupted by movement.

A major result from this proposal was that the structural split between DP and non-DP *wh*/focus could straightforwardly be derived in a principled way. Assuming that Tagalog has a focus position in its clausal left periphery, and that this focus position is not one where Case is assigned (both straightforward assumptions), we arrived at the result that only XPs which do not require Case licensing (i.e., non-DPs) would be able to form questions and focus constructions by movement to this position. The proposed approach improves on existing proposals (Aldridge 2002; Mercado 2004) that attempt to address this structural split, as it solves an overgeneration problem whereby (certain types of) DPs were incorrectly predicted to be able to undergo focus fronting. The proposed incompatibility between DPs and the left peripheral position in Tagalog excludes this possibility.

Another consequence of restricting the movement of DPs generally in Tagalog is that other processes like relative clause formation are affected as well. Clearly, if DPs generally cannot move to A'-positions, then we predict elements such as DP relative pronouns to also show the same behavior. Thus, to derive DP relative clauses (i.e., linker RCs, shown in (5)), I proposed in Section 5.3 an analysis based on a null pronoun *pro* with particular syntactic and semantic properties.

- (5) S<um>ayaw ang pinsa[n]=ng [b<in>igy-an ko ng regalo].  
 <AV>dance(PFV) NOM cousin=LK <PFV>give-LV 1SG.GEN GEN gift  
 'The cousin [who I gave a gift] danced.'

I posited that *pro* introduced a semantic variable to be bound higher in the structure (deriving the intended semantics), but that this binding was subject to a locality constraint. The different ways in which this constraint could be satisfied thus resulted in the distribution of possible DP A'-dependencies. For example, for the cases that conform to the pivot-only restriction on A'-dependency formation, I proposed that the locality constraint was satisfied by *pro* undergoing pivot movement to Spec-AgrP to escape the thematic domain. Further support for this *pro*-based analysis of DP relative clauses in Tagalog came from two domains: long-distance dependencies and DP dependencies which violate the pivot-only restriction.

Long-distance dependencies were discussed in the remainder of Chapter 5 (Sections 5.4–5.6), which showed that *pro* could also be used to derive these constructions and the successive-cyclic behavior they exhibit (i.e., the Matrix Verb Constraint illustrated in (6)).

- (6) Tulóg ang pinsa[n]=ng [{s<in>abi ko /\*nag-sabi ako}=ng [bi~bigy-an ko ng regalo]].  
 asleep NOM cousin=LK <PFV>say[PV] 1SG.GEN AV.PFV-say 1SG.NOM=LK FUT~give-LV 1SG.GEN GEN gift  
 'The cousin [who I said [I was going to give a gift]] is asleep.'

The result was something of a hybrid analysis between traditional movement and non-movement analyses of A'-dependencies, which I showed to correctly capture certain other properties of Tagalog long-distance dependencies that are problematic for non-hybrid approaches. Specifically, we saw that it avoided problems for a pure movement analysis (e.g., Rackowski and Richards 2005) relating to the reduced ability or

inability of non-DPs to form long-distance dependencies, as well as problems deriving the correct intensional semantics for a pure non-movement analysis that accounted for the Matrix Verb Constraint as a non-successive-cyclic phenomenon (i.e., Kaufman 2011).

Chapter 6 provided further support for the *pro*-based analysis by demonstrating that the proposed locality constraint on the binding of *pro* could be satisfied by other means, which in turn account for the distribution of the DP A'-dependencies that violate the pivot-only restriction (i.e., the voice-disagreeing dependencies). We saw that an alternative mechanism to pivot movement was genitive inversion, which targeted the external (but not internal) arguments of nominal and verbal constructions, moving them to a structurally high position crucially outside of the thematic domain (Section 6.2). I thus argued mechanism was responsible for deriving two subclasses of the voice-disagreeing dependencies, genitive agent dependencies (Section 6.3) and subextraction dependencies (Section 6.4), exemplified in (7).

- (7) a. ?Nag-ipon ng pera ang bata=ng [bi~bigy-an  $t_{GEN}$  ang pinsan ko ng regalo].  
 AV.PFV-save.up GEN money NOM child=LK FUT~give-LV NOM COUSIN 1SG.GEN GEN gift  
 'The child [who is going to give my cousin a gift] saved up some money.'
- b. Ma-daldal ang bata=ng [bi~bigy-an ko [ang pinsan  $t_{GEN}$ ] ng regalo].  
 ADJ-talkative NOM child=LK FUT~give-LV 1SG.GEN NOM COUSIN GEN gift  
 'The child [whose cousin I'm going to give a gift] is talkative.'

We then saw in Section 6.5 that the locality constraint could also be satisfied with *pro* remaining in-situ if structure from the inflectional domain was absent, deriving the more flexible behavior of the free dependencies. We saw this with Recent Perfective clauses and *kay/napaka*-exclamatives, shown in (8), which exhibit this reduced structure and allow neither pivot movement nor genitive inversion, but nevertheless allow their DP arguments to be targeted for A'-dependency formation.

- (8) a. Na-sira ang regalo=ng [kabi~bigay ko lang  $t_{GEN}$  sa pinsan ko].  
 PFV-break NOM gift=LK RPFV~give 1SG.GEN only OBL COUSIN 1SG.GEN  
 'The gift [that I have just given to my cousin] has broken.'
- b. Naka-tanggap ako ng regalo=ng [{kay/napaka-} laki  $t_{GEN}$ ].  
 AV.NVOL.PFV-receive 1SG.NOM GEN gift=LK kay very-big  
 'I received a gift [that was {so/very} big].'

In this discussion, an important contrast came in the form of *ang*-exclamatives, which exhibit reduced properties similar to the other constructions considered, and also lack the two movement operations that allow *pro* to escape the thematic domain. Despite these similarities, we saw that these exclamatives did not allow the formation of A'-dependencies, as (9) shows. I argued that this discrepancy was accounted for by a key difference exhibited by *ang*-exclamatives: the presence of inflectional structure. Assuming that such structure interrupts the locality between the clause-edge operator and material within the thematic domain, *pro* in *ang*-exclamatives would need to escape the thematic domain to be bound by the operator. However, because no movement operations were available to *pro* in this context, we derived that A'-dependencies with this construction should be ill-formed.

- (9) \*Naka-tanggap ako ng regalo=ng [ang laki  $t_{GEN}$ ].  
 AV.NVOL.PFV-receive 1SG.NOM GEN gift=LK ang big  
 Intended: 'I received a gift [that was so big].'

### 8.3 On true A'-movement in Tagalog

Until the end of Chapter 6, the discussion in this thesis focused on the proposal for Case licensing and its implications for the movement of DPs. As mentioned above, this discussion formed a broad picture of Tagalog as a typologically strange language. I showed, however, that the unusual parts of the proposal turn out to be desirable, as they account for a number of phenomena in Tagalog, including the structural split in A'-dependency constructions, and the distribution of the DP-targeting subset of those constructions. In light of this proposal, the discussion of non-DP A'-dependencies in Chapter 7 was informative, as it showed that a corollary of sorts of the analysis previously proposed also holds. Since Case and the way it is licensed was the driving force behind many of the behaviors for DPs, we expect that those XPs which do not interact with Case should behave in a more cross-linguistically typical way.

In this chapter, I proposed an analysis for the non-DP A'-dependencies, the *kung* relative clauses and focus fronting shown in (10), based on conventional A'-movement, situating their behavior in the broader context of constructions which make use of the left periphery in Tagalog, for example topicalization constructions and embedded questions.

- (10) a. Na-sa mall ang tindahan [kung saan nila b<in>ili ang regalo]  
 PRED-OBL mall NOM store if where 3PL.GEN <PFV>buy[PV] NOM gift  
 'The store [where they bought the gift] is in the mall.'
- b. {Saan /Sa Canadian Tire} nila b<in>ili ang regalo.  
 where OBL Canadian Tire 3PL.GEN <PFV>buy[PV] NOM gift  
 'Where did they buy the gift?'  
 'It was at Canadian Tire that they bought the gift.'

The analysis of these constructions was couched in the articulated clausal left periphery of Rizzi (1997), such that relativization and focalization of non-DPs involved A'-movement to distinct positions at the left edge of the clause. We saw in Section 7.3 that this approach was supported by the existence of relative word order effects among different types of constituents occupying the clause edge. Thus, unlike A'-dependencies of DPs, those of non-DPs show behavior that fits well into existing frameworks for analyzing these clause-level operations.

A further point that was illustrated in this chapter was the persistence of the structural split between DP and non-DP A'-dependencies that served as the one of the main motivations of the thesis. Across a number of environments, we saw that DP A'-dependencies were formed using the DP strategies (linker RCs and pseudoclefts) and non-DP A'-dependencies were formed using the non-DP strategies (*kung*-RCs and focus fronting). This was discussed in Section 7.1, where we saw, for example, that even with the reduced structure of the recent perfective as in (11), non-DPs could not be targeted using the DP strategies, even when the non-DP strategies themselves were ungrammatical.

- (11) Na-sa mall ang tindahan{\*=ng/kung saan} kabi~bili ko lang ng sapatos.  
 PRED-OBL mall NOM store =LK if where RPFV~buy 1SG.GEN only GEN shoe  
 ‘The store [where I have just bought shoes] is in the mall.’

To a lesser extent, we also saw this persistence in the fact that embedded questions of DPs involved embedded pseudoclefts. While this embedding resulted in a *kung+wh* sequence parallel to what is found in *kung*-RCs, we saw, as (12) illustrates, that this did not result in the *kung*-RC strategy being available for DPs.

- (12) a. T<in>anong ko [kung sino ang <um>i~iyak].  
 <PFV>ask[PV] 1SG.GEN if who.NOM NOM AV.IMPF~cry  
 ‘I asked who was crying.’
- b. \*K<in>ausap ko ang bata [kung sino ang <um>i~iyak].  
 <PFV>speak.with[PV] 1SG.GEN NOM child if who.NOM NOM AV.IMPF~cry  
 Intended: ‘I talked to the child who was crying.’

I argued that this persistence shows us that the split must be due to a property intrinsic to the XPs being targeted (i.e., category or some proxy of it) rather than a more incidental property (e.g., appearance in certain environments).

## 8.4 Looking ahead

The breadth of data considered in this thesis ultimately required practical considerations to be taken into account during the course of this undertaking. As such, this thesis leaves a number of issues and empirical domains unaddressed, and raises a number of questions that are left unanswered, but may potentially be fruitful research directions. I close this thesis by discussing some of these issues and possible future directions briefly.

Perhaps the most significant such issue is the question of what underlies the proposed locality requirement on the binding of *pro*. In this thesis, I have argued that the distribution of the gap in DP-targeted *A'*-dependencies robustly follows a generalization best framed in terms of locality between a structurally high element (the operator) and a structurally low one (*pro*). However, as discussed in Section 6.6, issues remain in terms of formulating a concrete formalization of this generalization.

Some of these issues may be resolved by considering an even broader range of data than was covered by this thesis. For example, a number of attested phenomena falling under the umbrella of restriction-violating dependencies were not considered. This includes constructions like comparisons of equality (13) and apparent cases of two simultaneous DP dependencies (14). In cases like the former, a more thorough understanding of the structure of non-verbal predicates, in particular of adjectives, is needed.

- (13) Na-dismaya ang doktor na [kasing-tangkad ang bata].  
 PFV-disappoint NOM doctor LK as.ADJ.as-tall NOM child  
 ‘The doctor whom the child is as tall as was disappointed.’ (modeled after Ceña 1979, ex.20)

(14) Si Presentacion ang gulay lang ang k<in>a~kain.

NOM.P Presentacion NOM vegetable only NOM IMPF~eat[PV]

‘It’s Presentacion who eats only vegetables.’

Or: ‘[The one who [[what (they<sub>SG</sub>) eat] is only vegetables]] is Presentacion.’

Some of this additional data also suffers from issues of reduced grammaticality, thus limiting the effectiveness of traditional elicitation work in teasing apart contrasts. For example, we might expect subextraction dependencies to be possible out of gerunds, given that they allow genitive inversion (Sec. 6.2). However, the data I have been able to gather on this has been equivocal. To this end, more experimentally controlled means of testing these kinds of judgments would likely be beneficial (see, e.g., Pizarro-Guevara and Wagers 2018). Moreover, such work could potentially allow for the testing of hypotheses for answering the question that I have left open here of why this reduced grammaticality is attested in the first place.

Moving away from the core phenomenon of  $A'$ -dependencies, questions also remain about how exactly the morphological spell-out of  $\text{Agr}^0$  (i.e., voice morphology) is determined. While I argued in Section 3.1 that this issue was ultimately secondary to the main research questions, it is nevertheless a central issue in Tagalog clause structure, and proposals in this broader area should at least not preclude an analysis of this morphology. However, such analyses require detailed investigation not only of argument structure and its alternations in Tagalog—as recent work (e.g., Chen 2017; Rackowski 2002) has demonstrated—but likely also of fine lexical semantic differences, as we see from more descriptive works on this subject (e.g., McFarland 1976; Ramos 1974). Similarly, I have left open a number of questions about the mechanisms behind genitive inversion (Section 6.2.5), such as why this process is restricted to pronouns as well as what triggers inversion in the first place.

Finally, a few questions with cross-linguistic implications arise from the analysis proposed in this thesis. First, we have the pivot-only restriction, which is attested in some form or another across many Austronesian languages. Can the *pro*-binding analysis be extended to other languages? That is, how much of the cross-linguistic data can we account for by adopting the view that the binding of a null pronoun can be fed by independently available movement processes? This amounts to asking whether or not the distribution of possible  $A'$ -dependencies in a language is predicted by the kinds of movement available to different DPs. Where independent movement operations are more limited, we would expect a stricter manifestation of the pivot-only restriction, and vice versa. To this end, further investigation of processes similar to genitive inversion in other languages may prove fruitful towards developing a more complete analysis of this restriction.

Second is the DP/non-DP split derived by the existence of two distinct  $A'$ -dependency formation mechanisms whose distribution is determined by other properties of the language (e.g., Case). What, then, is the cross-linguistic prevalence of such splits, and how do they manifest in a language? Within Austronesian, for example, we can contrast *wh*-questions in Northern Amis to those in Malagasy. While the former show a potentially parallel split to the one found in Tagalog (Bril 2016)—observe the contrast between the nominative marker *ku* and the complementizer *a* in (15)—the latter do not (Potsdam 2009), as evidenced by the consistent appearance of the particle *no* in (16). Under the analysis laid out in this thesis, we might expect to find differences in the way abstract Case behaves between the two languages.

- (15) *Wh*-QUESTIONS IN NORTHERN AMIS (Bril 2016, ex.71, glosses slightly modified)
- a. Cima **ku** cih-en n-i Balah?  
 who NOM scold-PV GEN-P Balah  
 ‘Who did Balah scold?’
- b. Cima-**an a** mi-cihi ci Balah?  
 who-LOC COMP AV-scold NOM.P Balah  
 ‘At whom is Balah yelling?’
- (16) *Wh*-QUESTIONS IN MALAGASY (Potsdam 2006, ex.5, glosses slightly modified)
- a. Iza **no** nihomehy?  
 who PRT laugh.AV  
 ‘Who laughed?’
- b. Taiza **no** nividy vary Raso?  
 where PRT buy.AV rice Raso  
 ‘Where did Raso buy rice?’

Moving away from Austronesian, similar patterns appear to be attested in Mayan as well. For example, headed relative clauses in Chuj disallow overt *mach* ‘who’ and *tas* ‘what’ as relative pronouns, but either allow or require others like *b’ajt’il* ‘where’ and *tas yuj* ‘why’ (Royer 2020). (17) below shows this for ‘who’ and ‘where’.

- (17) HEADED RELATIVES IN CHUJ (Royer 2020, exx.35–36, modified slightly)
- a. Ix-in-chel [winh winak (**\*mach**) lan y-ok’-i].  
 PFV-A1SG-hug N.CLF man who PROG A3-CRY-IV  
 ‘I hugged the man who was crying.’
- b. Chakchak te’ pat [**(b’ajt’il)** ix-in-aj-i].  
 red N.CLF house where PFV-B1SG-be.born-IV  
 ‘The house where I was born is red.’

Similarly, headed relative clauses in Ch’ol use different strategies, depending on whether the target is a nominal argument or not Vázquez Álvarez and Coon (2020). Those targeting nominal arguments use a gap strategy shown in (18a) featuring a clitic particle =*bä* but no overt *wh*-expression (*majch* ‘who’ or *chu* ‘what’). On the other hand, locative and temporal relative clauses show overt *wh*-expressions *ba’* ‘where’, shown in (18b), and *jalaj* ‘when’.

- (18) HEADED RELATIVE SI CH’OL (Vázquez Álvarez and Coon 2020)
- a. Tyi j-kãñ-ä-ø wiñik [**(\*majch)** ta’=**bä** tyäl-i-ø].  
 PFV A1-KNOW-TV-B3 man who PFV=REL come-IV-B3  
 ‘I met the man who arrived.’ (exx.48a,50; combined)
- b. Tyi pul-i-ø klesia [**ba’** tyi och-i-y-oñ tyi ch’ujel].  
 PFV burn-IV-B3 church where PFV enter-IV-EP-B1 PREP mass  
 ‘The church where I went to mass burned down.’ (ex.43a)

The data from Mayan is interesting for a number of reasons.<sup>1</sup> First, at least in the two languages noted above, the DP/non-DP split seems to only be attested in headed relative clauses, and not in *wh*-questions. Second, (a subset of) Mayan languages are known to exhibit restrictions on the formation of

<sup>1</sup>See Caponigro et al. 2020 for discussion of headed relatives and related constructions in more Mayan languages and other Mesoamerican languages more broadly.

A'-dependencies that are reminiscent of the Tagalog pivot-only restriction (see Stiebels 2006 for a detailed overview). One analysis of such restrictions is proposed by Coon et al. (2014), who adopt a phase-and-licensing-based account of the attested variation in the language family. Interestingly, they note that in some of these languages, structurally low non-DPs (adjuncts) are subject to the A'-restrictions in a way that structurally high ones are not, which is what we would expect on a phase-based account. The behavior of DPs and non-DPs with respect to A'-dependencies in Tagalog (and perhaps Austronesian more broadly) and Mayan thus exhibits interesting similarities (e.g., the structural split in relative clause strategies) and differences (e.g., accessibility of non-DPs). Research comparing the issue of DP and non-DP dependencies in these language families thus has strong potential to enrich our general understanding of A'-dependencies and the restrictions on their formation.

In conclusion, this thesis has provided a proposal for the A'-dependency system of Tagalog by considering a broader range of phenomena than was previously typical. In doing so, this proposal addresses a number of overlooked issues, particularly the apparent exceptions to the pivot-only restriction and the structural differences between A'-dependency constructions, which have in some sense been lying in plain sight. While the thesis leaves many questions unanswered, it provides a novel framework for understanding A'-dependencies in Tagalog, in turn making clear a number of predictions that can be tested and opening up novel ways of approaching the syntax of this language.



# Bibliography

- Abney, Steven. 1987. The English noun phrase in its sentential aspect. Doctoral Dissertation, MIT.
- Adger, David, and Gillian Ramchand. 2003. Predication and equation. *Linguistic Inquiry* 34:325–359. URL <http://dx.doi.org/10.1162/002438903322247515>.
- Aldridge, Edith. 2002. Nominalization and *Wh*-movement in Seediq and Tagalog. *Language and Linguistics* 3:393–426.
- Aldridge, Edith. 2003a. Remnant movement in Tagalog relative clause formation. *Linguistic Inquiry* 34:631–640. URL <http://dx.doi.org/10.1162/002438903322520179>.
- Aldridge, Edith. 2003b. *Wh*-movement in Seediq and Tagalog. In *Proceedings of AFLA 8*, ed. Andrea Rackowski and Norvin Richards, volume 44 of *MIT Working Papers in Linguistics*, 1–28.
- Aldridge, Edith. 2004a. Ergativity and word order in Austronesian languages. Doctoral Dissertation, Cornell University.
- Aldridge, Edith. 2004b. Internally headed relative clauses in Austronesian languages. *Language and Linguistics* 5:99–129. URL [http://www.ling.sinica.edu.tw/LL/en/ejournal.Content/5\\_1](http://www.ling.sinica.edu.tw/LL/en/ejournal.Content/5_1).
- Aldridge, Edith. 2009. Minimalist questions for the nominalist analysis of Tagalog syntax. *Theoretical Linguistics* 35:51–62.
- Aldridge, Edith. 2012. Antipassive and ergativity in Tagalog. *Lingua* 122:192–203.
- Aldridge, Edith. 2017a. Internally and externally headed relative clauses in Tagalog. *Glossa: a journal of general linguistics* 2:41.1–33.
- Aldridge, Edith. 2017b.  $\phi$ -feature competition: A unified approach to the Austronesian extraction restriction. In *Proceedings of CLS52*, ed. Jessica Kantarovich, Tran Truong, and Orest Xherija, 313–326.
- Almario, Virgilio, ed. 2010. *UP diksiyonaryong Filipino [UP Filipino dictionary]*. Manila: Anvil Publishing, 2 edition.
- Arregi, Karlos, Itamar Francez, and Martina Martinović. 2018. Specificational subjects are individual concepts. *Lingbuzz/003996*, May 2018.
- Baker, Mark, and Nadya Vinokurova. 2010. Two modalities of case assignment: case in Sakha. *Natural Language & Linguistic Theory* 28:593–642.

- Baker, Mark C., and Chris Collins. 2006. Linkers and the internal structure of *vp*. *Natural Language & Linguistic Theory* 24:307–354.
- Bljár, Susana, and Diane Massam. 1999. Multiple case checking. *Syntax* 2:65–79.
- Bell, Sarah. 1976. Cebuano subjects in two frameworks. Doctoral Dissertation, MIT.
- Bell, Sarah J. 1983. Advancements and ascensions in Cebuano. In *Studies in relational grammar*, ed. David Perlmutter, volume 1, chapter 5, 143–218. Chicago: University of Chicago Press.
- Bhatt, Rajesh. 2002. The raising analysis of relative clauses: Evidence from adjectival modification. *Natural Language Semantics* 10:43–90.
- Bliss, Heather. 2014. Assigning reference in clausal nominalizations. In *Cross-linguistic investigations of nominalization patterns*, ed. Ileana Paul, 85–117. Amsterdam: John Benjamins Publishing Company.
- Bondoc, Ivan Paul, and Amy J. Schafer. 2019. Revisiting Tagalog word order preferences. Paper presented at the 26th Annual Meeting of the Austronesian Formal Linguistics Association (AFLA 26).
- Branan, Kenyon. 2018. Attraction at a distance:  $\bar{A}$ -movement and case. *Linguistic Inquiry* 49:409–440.
- Bril, Isabelle. 2016. Information structure in Northern Amis: A morphosyntactic analysis. *Oceanic Linguistics* 55:449–479.
- Burzio, Luigi. 1986. *Italian syntax: a government-binding approach*, volume 1 of *Studies in Natural Language and Linguistic Theory*. Dordrecht: Springer.
- Caponigro, Ivano, Harold Torrence, and Roberto Zavala Maldonado, ed. 2020. *Headless relative clauses in mesoamerican languages*. Oxford University Press.
- Carrier-Duncan, Jill. 1985. Linking of thematic roles in derivational word formation. *Linguistic Inquiry* 16:1–34. URL <https://www.jstor.org/stable/4178418>.
- Ceña, Resty M. 1979. Tagalog counterexamples to the Accessibility Hierarchy. *Studies in Philippine Linguistics* 3:119–124. URL <https://www.sil.org/resources/archives/25963>.
- Chen, Tingchun. 2018a. Multiple case assignment: An Amis case study. Doctoral Dissertation, MIT.
- Chen, Tingchun. 2018b. Multiple case assignment in Amis: evidence from case-stacking. In *NELS 48: Proceedings of the Forty-Eighth Annual Meeting of the North East Linguistic Society*, ed. Sherry Hucklebridge and Max Nelson, volume 2, 111–124. URL <http://ling.auf.net/lingbuzz/004382>.
- Chen, Victoria. 2017. A reexamination of the Philippine-type voice system and its implications for Austronesian primary-level subgrouping. Doctoral Dissertation, University of Hawai'i at Manoa.
- Chomsky, Noam. 1981. *Lectures on Government and Binding: The Pisa lectures*. Studies in Generative Grammar. Dordrecht: Foris.
- Chomsky, Noam. 1995. *The minimalist program*. Cambridge, MA: MIT Press. URL <https://muse.jhu.edu/book/36980>.

- Chomsky, Noam. 2001. Derivation by phase. In *Ken Hale: A life in language*, ed. Michael Kenstowicz, chapter 1, 1–52. Cambridge, MA: MIT Press.
- Chung, Sandra. 1982. Unbounded dependencies in Chamorro grammar. *Linguistic Inquiry* 13:39–77. URL <https://www.jstor.org/stable/4178259>.
- Chung, Sandra, and Carol Georgopoulos. 1988. Agreement with gaps in Chamorro and Palauan. In *Agreement in natural language: Approaches, theories, descriptions*, ed. Michael Barlow and Charles Ferguson, 251–267. CSLI.
- Cole, Peter, and Gabriella Hermon. 1998. The typology of *Wh*-movement: *Wh*-questions in Malay. *Syntax* 1:221–258.
- Collins, James N. 2019. Definiteness determined by syntax. *Natural Language & Linguistic Theory* 37:1367–1420.
- Coon, Jessica, Pedro Mateo Pedro, and Omer Preminger. 2014. The role of case in A-bar extraction asymmetries: Evidence from Mayan. *Linguistic Variation* 14:179–242.
- Cruz, Emilita L. 1975. *A subcategorization of Tagalog verbs*. Quezon City, Philippines: University of the Philippines.
- Culwell-Kanarek, Nathan. 2005. Pre-verbal pronouns in Tagalog syntax. In *Proceedings of the Twelfth Annual Conference of the Austronesian Formal Linguistics Association*, ed. Jeffrey Heinz and Dimitrios Ntelitheos, number 12 in UCLA Working Papers in Linguistics, 49–56.
- Davies, William D. 2003. Extreme locality in Madurese *Wh*-questions. *Syntax* 6:237–259.
- Deal, Amy Rose. 2015. Interaction and satisfaction in  $\phi$ -agreement. In *NELS 45: Proceedings of the Forty-Fifth Annual Meeting of the North East Linguistic Society*, ed. Thuy Bui and Deniz Özyıldız.
- Dell, François. 1983. An aspectual distinction in Tagalog. *Oceanic Linguistics* 22/23:175–206.
- Diesing, Molly. 1992. *Indefinites*. Cambridge, MA: MIT Press.
- den Dikken, Marcel. 2006. *Relators and linkers: The syntax of predication, predicate inversion, and copulas*, volume 47 of *Linguistic Inquiry Monographs*. MIT Press.
- Erlewine, Michael Yoshitaka. 2018. Extraction and licensing in Toba Batak. *Language* 94:662–697.
- Erlewine, Michael Yoshitaka, Theodore Levin, and Coppe van Urk. 2015. What makes a voice system? on the relationship between voice marking and case. In *Proceedings of AFLA 21*, ed. Amber Camp, Yuko Otsuka, Claire Stabile, and Nozomi Tanaka, 51–67.
- Erlewine, Michael Yoshitaka, Theodore Levin, and Coppe van Urk. 2017. Ergativity and Austronesian-type voice systems. In *Oxford handbook of ergativity*, ed. Jessica Coon, Diane Massam, and Lisa deMena Travis, 373–396. Oxford University Press.
- Erlewine, Michael Yoshitaka, Theodore Levin, and Coppe van Urk. 2019. The typology of nominal licensing in Austronesian voice languages. Paper presented at the 26th Annual Meeting of the Austronesian Formal Linguistics Association (AFLA 26).

- Erlewine, Michael Yoshitaka, and Cheryl Lim. 2018. Bikol clefts and topics and the Austronesian subject-only extraction restriction. *Lingbuzz/004181*, September 2018.
- von Fintel, Kai, and Irene Heim. 2011. Intensional semantics. URL <http://mit.edu/fintel/fintel-heim-intensional.pdf>, MIT Lecture Notes.
- Georgala, Effi, Waltraud Paul, and John Whitman. 2008. Expletive and thematic applicatives. In *Proceedings of the 26th West Coast Conference on Formal Linguistics*, ed. Charles B. Chang and Hannah J. Haynie, 181–189. Somerville, MA: Cascadilla Proceedings Project. URL <http://www.lingref.com/cpp/wccfl/26/>.
- Georgala, Efthymia. 2012. Applicatives in their structural and thematic function: A minimalist account of multitransitivity. Doctoral Dissertation, Cornell University. URL <https://hdl.handle.net/1813/29290>.
- Gerassimova, Veronica, and Peter Sells. 2008. Long-distance dependencies in Tagalog: The case for raising. In *Proceedings of the 26th West Coast Conference on Formal Linguistics*, ed. Charles B. Chang and Hannah J. Haynie, 190–198. Cascadilla Proceedings Project.
- Gerds, Donna B. 1988. Antipassives and causatives in Ilokano: Evidence for an ergative analysis. In *Studies in Austronesian linguistics*, ed. Richard McGinn, number 76 in Monographs in International Studies Southeast Asia Series, chapter 10, 295–322. Athens, Ohio: Ohio University.
- Grimshaw, Jane. 2000. Locality and extended projection. In *Lexical specification and insertion*, ed. Peter Coopmans, Martin Everaert, and Jane Grimshaw. John Benjamins Publishing Company.
- Guilfoyle, Eithne, Henrietta Hung, and Lisa Travis. 1992. Spec of IP and spec of VP: Two subjects in Austronesian languages. *Natural Language & Linguistic Theory* 10:375–414.
- de Guzman, Videia P. 1988. Ergative analysis for Philippine languages: An analysis. In *Studies in Austronesian linguistics*, ed. Richard McGinn, number 76 in Monographs in International Studies Southeast Asia Series, chapter 11, 323–347. Athens, Ohio: Ohio University.
- Heggie, Lorie A. 1988. The syntax of copular structures. Doctoral Dissertation, University of Southern California.
- Heim, Irene. 1982. The semantics of definite and indefinite noun phrases. Doctoral Dissertation, University of Massachusetts, Amherst.
- Heim, Irene, and Angelika Kratzer. 1998. *Semantics in generative grammar*. Blackwell textbooks in linguistics. Blackwell Publishers.
- Himmelman, Nikolaus. 2005. Tagalog. In *The Austronesian languages of Asia and Madagascar*, ed. Alexander Adelaar and Nikolaus Himmelman, chapter 12, 350–376. Routledge.
- Himmelman, Nikolaus. 2016. Notes on “Noun Phrase Structure” in Tagalog. In *Explorations of the syntax-semantics interface*, ed. Jens Fleischhauer, Anja Latrouite, and Rainer Osswald, 319–342. Düsseldorf University Press. URL <http://dup.oa.hhu.de/id/eprint/526>.

- Hsieh, Henrison. 2016. Prosodic indicators of phrase structure in Tagalog transitive sentences. In *AFLA 23: The Proceedings of the 23rd Meeting of the Austronesian Formal Linguistics Association*, ed. Hiroki Nomoto, Takuya Miyauchi, and Asako Shiohara, 111–122. Canberra: Asia-Pacific Linguistics.
- Hsieh, Henrison. 2019. Distinguishing nouns and verbs: A Tagalog case study. *Natural Language & Linguistic Theory* 37:523–569.
- Hsieh, Henrison. 2020. On the structure of Tagalog non-DP extraction. In *Proceedings of the Twenty-Sixth Meeting of the Austronesian Formal Linguistics Association (AFLA)*, ed. Ileana Paul, 124–141. London, ON: University of Western Ontario. URL <https://ir.lib.uwo.ca/afla/aflaxxvi/meeting/8/>.
- Hsieh, Henrison, and Yining Nie. 2018. Where (and what) the Tagalog *kung*-CPs are. In *Heading in the right direction: Linguistic treats for Lisa Travis*, ed. Francesco Gentile, Jeffrey Lamontagne, Laura Kalin, Ileana Paul, and Jozina Vander Klok, 171–178. McGill Working Papers in Linguistics.
- Kaufman, Daniel. 2009. Austronesian nominalism and its consequences: A Tagalog case study. *Theoretical Linguistics* 35:1–49.
- Kaufman, Daniel. 2010. The morphosyntax of Tagalog clitics: A typologically driven approach. Doctoral Dissertation, Cornell University.
- Kaufman, Daniel. 2011. The nominalist hypothesis in Austronesian: Problems and prospects. University of Delaware Linguistics Colloquium Handout.
- Keine, Stefan. 2016. Probes and their horizons. Doctoral Dissertation, University of Massachusetts Amherst.
- Keine, Stefan. 2020. *Probes and their horizons*, volume 81 of *Linguistic Inquiry Monographs*. MIT Press.
- Kimenyi, Alexandre. 1980. *A relational grammar of Kinyarwanda*. Berkeley: University of California Press.
- Klimenko, Sergei B., and Divine Angeli P. Endriga. 2016. Semantic verb classes and regularity of voice paradigms in Tagalog. *Oceanic Linguistics* 55:480–499.
- Ko, Heejong. 2005. Syntax of *why-in-situ*: Merge into [Spec,CP] in the overt syntax. *Natural Language & Linguistic Theory* 23:867–916.
- Komisyon sa Wikang Filipino. 2014. *Ortograpiyang pambansa [National orthography]*. Manila, Philippines: Komisyon sa Wikang Filipino. URL <https://www.deped.gov.ph/2013/08/14/do-34-s-2013-ortograpiyang-pambansa/>.
- Koopman, Hilda, and Dominique Sportiche. 1991. The position of subjects. *Lingua* 85:211–258.
- Kratzer, Angelika. 1996. Severing the external argument from its verb. In *Phrase structure and the lexicon*, 109–137. Springer.
- Kroeger, Paul. 1993. *Phrase structure and grammatical relations in Tagalog*. Dissertations in Linguistics. Center for the Study of Language and Information.

- Latrouite, Anja. 2012. Differential object marking in Tagalog. In *Proceedings of AFLA 18*, ed. Lauren Eby Clemens, Gregory Scontras, and Maria Polinsky.
- Law, Paul. 2011. Raising in Tagalog. In *Proceedings of the 28th West Coast Conference on Formal Linguistics*, ed. Mary Byram Washburn, Katherine McKinney-Bock, Erika Varis, Ann Sawyer, and Barbara Tomaszewicz, 142–151. Somerville, MA: Cascadilla Proceedings Project.
- Law, Paul. 2015. The syntax of Tagalog relative clauses. In *Proceedings of AFLA 21*, ed. Amber Camp, Yuko Otsuka, Claire Stabile, and Nozomi Tanaka, 167–184. Asia-Pacific Linguistics.
- Law, Paul. 2016. The syntax of Tagalog relative clauses. *Linguistics* 54:717–768.
- Lee, Aldrin. 2018. The dual ‘when’ in selected Philippine languages: Its nature, distribution, and potential implications. Paper presented at the 28th Annual Meeting of the Southeast Asian Linguistics Society (SEALS 28), Wenzao Ursuline U of Languages, Kaohsiung, Taiwan.
- Legate, Julie Anne. 2012. Types of ergativity. *Lingua* 122:181–191.
- Levin, Theodore. 2015. Licensing without Case. Doctoral Dissertation, MIT.
- Lin, Jo-Wang. 1992. The syntax of *zenmeyang* ‘how’ and *weishenme* ‘why’ in Mandarin Chinese. *Journal of East Asian Linguistics* 1:293–331.
- Maclachlan, Anna. 1996. Aspects of ergativity in Tagalog. Doctoral Dissertation, McGill University.
- Marantz, Alec. 1984. *On the nature of grammatical relations*. Cambridge, MA: MIT Press.
- Marantz, Alec. 2000. Case and licensing. In *Arguments and case: Explaining Burzio’s Generalization*, ed. Eric Reuland, volume 34 of *Linguistik Aktuell*, 11–30. John Benjamins Publishing Company.
- Massam, Diane. 2000. VSO and VOS: Aspects of Niuean word order. In *The syntax of verb-initial languages*, ed. Andrew Carnie and Eithne Guilfoyle, 97–116. Oxford University Press.
- Massam, Diane, and Carolyn Smallwood. 1997. Essential features of predication in English and Niuean. In *Proceedings of NELS 27*, ed. Kiyomi Kusumoto, 263–272.
- McCarthy, John J., and Alan S. Prince. 1990. Foot and word in prosodic morphology: The Arabic broken plural. *Natural Language and Linguistic Theory* 8:209–283.
- McCloskey, James. 1990. Resumptive pronouns,  $\bar{A}$ -binding and levels of representation in Irish. In *Syntax of the modern Celtic languages*, ed. Randall Hendrick, volume 23 of *Syntax and Semantics*, 199–248. San Diego: Academic Press.
- McCloskey, James. 2002. Resumption, successive cyclicity, and the locality of operations. In *Derivation and explanation in the Minimalist Program*, ed. Samuel David Epstein and T. Daniel Seely, chapter 8, 184–226. Blackwell Publishers.
- McFarland, Curtis D. 1976. *A provisional classification of Tagalog verbs*. Number 8 in Study of Languages & Cultures of Asia & Africa Monograph Series. Tokyo: Institute for the Study of Languages and Cultures of Asia and Africa.

- McGinn, Richard. 1988. Government and Case in Tagalog. In *Studies in Austronesian linguistics*, ed. Richard McGinn, number 76 in Monographs in International Studies Southeast Asia Series, chapter 9, 275–293. Athens, Ohio: Ohio University.
- Mercado, Raphael. 2004. Focus constructions and WH-questions in Tagalog: A unified analysis. *Toronto Working Papers in Linguistics* 23:95–118. URL <https://twpl.library.utoronto.ca/index.php/twpl/issue/view/472>.
- Merchant, Jason. 2006. Polyvalent case, geometric hierarchies, and split ergativity. In *Proceedings of the 42nd annual meeting of the Chicago Linguistics Society*, ed. Jackie Bunting, Sapna Desai, Robert Peachy, Chris Straughn, and Zuzana Tomková, volume 2, 57–76. Chicago: Chicago Linguistic Society.
- Mikkelsen, Line. 2005a. *Copular clauses: Specification, predication and equation*, volume 85 of *Linguistik Aktuell*. John Benjamins.
- Mikkelsen, Line. 2005b. Subject choice in copular clauses. Ms., University of California Berkeley.
- Moro, Andrea. 1997. *The raising of predicates: Predicative noun phrases and the theory of clause structure*. Cambridge University Press.
- Nagaya, Naonori. 2011. Rise and fall of referentiality: Articles in Philippine languages. In *Nominalization in Asian languages: Diachronic and typological perspectives*, ed. Foong Ha Yap, Karen Grunow-Hårsta, and Janick Wrona, volume 96 of *Typological Studies in Language*, 589–625. John Benjamins.
- Nakamura, Masanori. 1993. An economy account of *wh*-extraction in Tagalog. In *Proceedings of the Twelfth West Coast Conference on Formal Linguistics*, ed. Erin Duncan, Donka Farkas, and Philip Spaelti, 405–420. Stanford: Center for the Study of Language and Information.
- Nakamura, Masanori. 1996. Economy of chain formation. Doctoral Dissertation, McGill University.
- Nakamura, Masanori. 2000. On raising in Tagalog. *Lingua* 110:391–408.
- Nie, Yining. 2019a. Raising applicatives and possessors in Tagalog. *Glossa: a journal of general linguistics* 4:139. 1–30.
- Nie, Yining. 2019b. Raising applicatives in Tagalog. Paper presented at the 26th Annual Meeting of the Austronesian Formal Linguistics Association (AFLA 26).
- Ntelitheos, Dimitrios. 2010. Gerundive nominals in Malagasy. *Oceanic Linguistics* 49:389–406. URL <https://muse.jhu.edu/article/411419>.
- Odango, Emerson Lopez, and Yuko Otsuka. 2015. *Ang*-marked NPs in recent perfective in Tagalog. Presentation slides, AFLA 22, McGill University.
- Or, Elsie Marie. 2015. Tagalog *ang-ang* constructions: The syntactic and semantic structure of Tagalog copular clauses. Unpublished term paper; University of the Philippines, Diliman.
- Otsuka, Yuko, and Nozomi Tanaka. 2016. Tagalog oblique relative clauses. Paper presented at the 23rd Annual Meeting of the Austronesian Formal Linguistics Association (AFLA 23), Tokyo University of Foreign Studies.

- Paul, Ileana. 2001. Concealed pseudo-clefts. *Lingua* 111:707–727.
- Payne, Thomas. 1982. Role and reference related subject properties and ergativity in Yup'ik Eskimo and Tagalog. *Studies in Language* 6:75–106.
- Pearson, Matt. 2001. T-marking on Malagasy obliques: tense, aspect, and the position of PPs. In *Papers in african linguistics 1*, ed. Harold Torrence, number 6 in UCLA Working Papers in Linguistics, 14–39. Los Angeles: UCLA Linguistics. URL <http://phonetics.linguistics.ucla.edu/wpl/issues/wp16.htm>.
- Pearson, Matthew. 2005. The Malagasy subject/topic as an A'-element. *Natural Language & Linguistic Theory* 23:381–457.
- Pizarro-Guevara, Jed, and Matt Wagers. 2018. Agent extraction under patient voice in Tagalog is acceptable: Evidence from acceptability ratings in various A'-dependencies. Paper presented at the 25th Annual Meeting of the Austronesian Formal Linguistics Association (AFLA 25).
- Potsdam, Eric. 2006. More concealed pseudoclefts and the clausal typing hypothesis. *Lingua* 116:2154–2182.
- Potsdam, Eric. 2009. Austronesian verb-initial languages and *wh*-question strategies. *Natural Language & Linguistic Theory* 27:737–771.
- Pylkkänen, Liina. 2002. Introducing arguments. Doctoral Dissertation, MIT.
- Rackowski, Andrea. 2002. The structure of Tagalog: Specificity, voice, and the distribution of arguments. Doctoral Dissertation, MIT.
- Rackowski, Andrea, and Norvin Richards. 2005. Phase edge and extraction: A Tagalog case study. *Linguistic Inquiry* 36:565–599.
- Ramos, Teresita V. 1971. *Tagalog structures*. PALI Language Text: Philippines. University of Hawaii Press.
- Ramos, Teresita V. 1974. *The case system of Tagalog verbs*. Number 27 in Pacific Linguistics Series B. Canberra: Department of Linguistics, Research School of Pacific Studies, Australian National University. URL <http://hdl.handle.net/1885/145134>.
- Richards, Norvin. 1991. Wh-extraction in Tagalog. Ms., Cornell University, Ithaca, NY.
- Richards, Norvin. 1998. Syntax vs. semantics in Tagalog wh-extraction. In *Recent papers in Austronesian linguistics*, ed. Matthew Pearson, volume 21 of *UCLA Occasional Papers in Linguistics*, 259–275. Los Angeles: UCLA.
- Richards, Norvin. 2000. Another look at Tagalog subjects. In *Formal issues in austronesian linguistics*, ed. Ileana Paul, Vivianne Phillips, and Lisa Travis, volume 49 of *Studies in Natural Language and Linguistic Theory*, 105–116. Dordrecht: Springer Science+Business Media.
- Richards, Norvin. 2009a. Nouns, verbs, and hidden structure in Tagalog. *Theoretical Linguistics* 35:139–152.
- Richards, Norvin. 2009b. The Tagalog copula. In *Proceedings of AFLA 16*.



- Richards, Norvin. 2016. *Contiguity theory*, volume 73 of *Linguistic Inquiry Monographs*. Cambridge, MA: MIT Press. URL <https://muse.jhu.edu/book/46474>.
- Richards, Norvin. 2020. Immobile wh-phrases in Tagalog. URL <https://ling.auf.net/lingbuzz/005294>, [lingbuzz/005294](https://ling.auf.net/lingbuzz/005294), July 2020.
- Rizzi, Luigi. 1990. *Relativized minimality*. Cambridge, MA: MIT Press.
- Rizzi, Luigi. 1997. The fine structure of the left periphery. In *Elements of grammar*, ed. Liliane Haegeman. Dordrecht: Springer.
- Romero, Maribel. 2005. concealed questions and specificational subjects. *Linguistics and Philosophy* 28:687–737.
- Ross, Malcolm. 2002. The history and transitivity of western austronesian voice and voice-marking. In *The history and typology of western austronesian voice systems*, ed. Fay Wouk and Malcolm Ross, 17–62. Canberra: Pacific Linguistics.
- Ross, Malcolm. 2009. Proto Austronesian verbal morphology: A reappraisal. In *Austronesian historical linguistics and culture history: A festschrift for Robert Blust*, ed. Alexander Adelaar and Andrew Pawley, 295–326. Canberra: Pacific Linguistics.
- Royer, Justin. 2020. Headless relative clauses in Chuj. In *Headless relative clauses in mesoamerican languages*, ed. Ivano Caponigro, Harold Torrence, and Roberto Zavala Maldonado, chapter 10. Oxford University Press. URL <https://ling.auf.net/lingbuzz/004356>.
- Ryan, Kevin M. 2010. Variable affix order: Grammar and learning. *Language* 86:758–791.
- Sabbagh, Joseph. 2005. Nonverbal argument structure: evidence from Tagalog. Doctoral Dissertation, MIT.
- Sabbagh, Joseph. 2014. Word order and prosodic-structure constraints in Tagalog. *Syntax* 17:40–89.
- Sabbagh, Joseph. 2016. Specificity and objecthood in Tagalog. *Journal of Linguistics* 52:639–688.
- Salanova, Andrés Pablo. 2011. Relative clauses in Mëbengokre. In *Subordination in native South American languages*, ed. Rik van Gijn, Katharina Haude, and Pieter Muysken, volume 97 of *Typological Studies in Language*, 45–78. Amsterdam: John Benjamins Publishing Company.
- Santiago, Alfonso O. 2003. *Sining ng pagsasaling-wika (sa Filipino mula sa Ingles)*. Manila: Rex Bookstore, Inc., 3rd edition. URL <https://books.google.ca/books?id=UI3vGukQsUEC>, last accessed via Google Books on 2019-07-26.
- Schachter, Paul. 1976. The subject in Philippine languages: Topic, actor, actor-topic, or none of the above? In *Subject and topic*, ed. Charles Li, 491–518. New York: Academic Press.
- Schachter, Paul. 1996. The subject in Tagalog: Still none of the above. *UCLA Occasional Papers in Linguistics* 15:1–61.
- Schachter, Paul, and Fe Otones. 1972. *Tagalog reference grammar*. University of California Press.

- Stepanov, Arthur, and Wei-Tien Dylan Tsai. 2008. Cartography and licensing of *wh*-adjuncts: a cross-linguistic perspective. *Natural Language & Linguistic Theory* 26:589–638.
- Stiebels, Barbara. 2006. Agent focus in Mayan languages. *Natural Language & Linguistic Theory* 24:501–570.
- Szabolcsi, Anna. 1981. The semantics of topic-focus articulation. In *Formal methods in the study of language*, ed. Jeroen Groenendijk, Theo Janssen, and Martin Stokhof. Amsterdam: Matematisch Centrum.
- Tanaka, Nozomi, William O’Grady, Kamil Deen, Chae-Eun Kim, Ryoko Hattori, Ivan Paul M. Bondoc, and Jennifer U. Soriano. 2016. An agent advantage in Tagalog relative clause comprehension. In *Proceedings of AFLA 22*, ed. Henrison Hsieh, 191–201. Asia-Pacific Linguistics.
- Toosarvandani, Maziar. 2011. The role of nominalization in Northern Paiute relative clause formation. In *Proceedings of the 16th Workshop on the Structure and Constituency of the Languages of the Americas*, ed. Alexis Black and Meagan Louie, UBC Working Papers in Linguistics, 151–165. URL <http://lingpapers.sites.olt.ubc.ca/files/2018/01/2011WSCLA16-Toosarvandani-n.pdf>.
- Toosarvandani, Maziar. 2014. Two types of deverbal nominalization in Northern Paiute. *Language* 90:786–833.
- Travis, Lisa. 2000a. Event structure in syntax. In *Events as grammatical objects: The converging perspectives of lexical semantics and syntax*, ed. Carol Tenny and James Pustejovsky, chapter 4, 145–186. Stanford: CSLI Publications.
- Travis, Lisa. 2000b. The L-syntax/S-syntax boundary: Evidence from Austronesian. In *Formal issues in Austronesian linguistics*, ed. Ileana Paul, Vivianne Phillips, and Lisa Travis, volume 49 of *Studies in Natural Language and Linguistic Theory*, 167–194. Dordrecht: Springer Science+Business Media.
- Travis, Lisa. 2001. Derived objects in Malagasy. In *Objects and other subjects*, ed. William Davies and Stanley Dubinsky, volume 52 of *Studies in Natural Language and Linguistic Theory*, 123–155. Dordrecht: Springer.
- Tsai, Wei-Tien Dylan. 2008. Left periphery and *how-why* alternations. *Journal of East Asian Linguistics* 17:83–115.
- Vázquez Álvarez, Juan Jesús, and Jessica Coon. 2020. Headless relative clauses in Ch’ol. In *Headless relative clauses in mesoamerican languages*, ed. Ivano Caponigro, Harold Torrence, and Roberto Zavala Maldonado, chapter 11. Oxford University Press, november edition. URL <https://sites.google.com/view/mesoamerican/book>.
- Woolford, Ellen. 2006. Lexical Case, inherent Case, and argument structure. *Linguistic Inquiry* 37:111–130.