

The Predictive Power of Lexical Semantics on the Acquisition of Passive Voice
in Young Children

Emma Nguyen, PhD

University of Connecticut, 2021

This dissertation focuses on the acquisition of the English verbal *be*-passive and the interaction between the lexical meaning of a verb and young children's observed behavior with the verb in the passive. Specifically, I investigate how children exploit lexical semantic information from their input in order to learn which verbs can passivize and which cannot.

The rest of the dissertation is organized in the following way: In Chapter 2, I introduce the case study of passives and discuss previous research on the acquisition of verbal passives in English and how lexical features can play a pivotal role in explaining children's understanding of verbal passives. In Chapter 3, I present a corpus study on the relationship between children's age of acquiring a verb in the verbal passive and the linguistic input that is available to them. In Chapter 4, I present a behavioral study in which I test whether linguistic behavior within a group of children can be predicted by a verb's lexical feature makeup. In Chapter 5, I model the developmental trajectory that we've seen in Chapters 2 and 3 via a naive Bayesian learner to explore an acquisition story where children are impacted by lexical features. In Chapter 6, I present a behavioral study on how children deal with the passivization of novel (i.e., nonce) verbs with different lexical feature makeups in an experimental context in which children's linguistic input is tightly controlled. Specifically, I test children's reliance on particular lexical features as predicted by the computational model developed in the previous chapter. In Chapter 7, I discuss directions for future work and conclude the dissertation by underscoring the importance of considering lexical semantic features when investigating the development of syntactic knowledge.

The Predictive Power of Lexical Semantics on the Acquisition of Passive Voice
in Young Children

Emma Nguyen

B.A., University of Maryland, College Park, 2013

M.A., University of Connecticut, 2017

A Dissertation

Submitted in Partial Fulfillment of the

Requirements for the Degree of

Doctor of Philosophy

at the

University of Connecticut

2021

Copyright by
Emma Nguyen

2021

iii

Doctor of Philosophy Dissertation
The Predictive Power of Lexical Semantics on the Acquisition of Passive Voice
in Young Children

Presented by
Emma Nguyen, B.A., M.A.

Approved by
Major Advisor: William Snyder
Associate Advisor: Diane Lillo-Martin
Associate Advisor: Letitia Naigles
Associate Advisor: Lisa Pearl

University of Connecticut

2021

“What we know is a drop; what we don’t know is an ocean.”

– Various Characters, Dark (2017-2020)

Acknowledgements

"I climbed a mountain
Not knowing that I had
Thought it was just a road from A to B"
- Sitting on the Roof of the World, Dido

If I were able to thank everyone that played a part in this dissertation and my career as a linguist, this dissertation would double in its size. Alas, I will try to keep my acknowledgments to a few pages. To those I couldn't thank by name here, please know that I have thought about all of you while writing this.

I would not have been able to finish this dissertation without the guidance and support of my dissertation committee: William Snyder, Lisa Pearl, Diane Lillo-Martin, and Letitia Naigles. Without them, none of this work would have been possible. It has been an honor to have been advised by such a powerhouse of incredibly intelligent people who were asking questions about how a child learned her native language long before I even knew what linguistics was.

Thank you to William Snyder for always pushing me to see and consider the big picture. For showing me how science should be done, I would not be where I am without him.

Many thanks to Lisa Pearl for her listening ear and her enduring patience with me and my many frustrations. She has shaped my entire way of thinking about the problem of language acquisition and I am grateful for every meeting we've had together.

This dissertation would not exist without Diane Lillo-Martin. Throughout this process, Diane has kept me honest and accountable. She motivated me to share my words and my thoughts even when I was the most insecure. She got me to the finish line.

I am entirely grateful to Letty Naigles for sharing her time and her expertise with me. Our meetings were fun, insightful, and made me eager to do science. I am continually inspired by Letty and her ability to look at a problem from outside of the box and bridge the gap between psychology and linguistics.

Special thanks to Jon Sprouse for wanting me to be the best scientist that I can be, to ask the biggest questions, and to conquer the world. Jon's perspective on science, and linguistics in particular, grounds me as an academic.

None of the work that I've done so far would be possible without the help of some incredible research assistants, coordinators, teachers, parents, and especially the children and adult participants. I offer my deepest gratitude to my research assistants, Anna Holden and Rachel Byrne, and everyone at the Discovery Depot and the Connecticut Science Center. Special thanks to Sara DeAngelo at UConn KIDS who has gone above and beyond with helping me recruit participants for my studies in rural Connecticut. Thank you for spending so many of your summer days with me at the Science Center.

Part of this research was done when I visited UC-Irvine during Spring 2016. A newcomer in a strange land (a.k.a. Southern California), Galia Bar-Sever and KJ Savinelli incorporated me into their wild gang of board game players, taco eaters, and beach-fire builders. It was weird. It was wonderful. It was positively magical. Since then, UCI has continued to be my intellectual home away from home, providing me with a community of computational modelers, including Greg Scontras and Richard Futrell, who are just a little bit nerdy but a whole lot of awesome.

This dissertation has benefited from discussions with many people including Ian Roberts, Nobert Corver, Martin Hackl, Tom Roeper, and Jill de Villiers. Special thanks to Kamil Ud Deen whom I am completely indebted to for crucial feedback on this research and unremitting support for my career. It is kind people like you who make this work possible.

My time at UConn has been remarkable to say the least. These have been some of the most formative years of my life and I'm honored to have learned from some of the best

people. I chose UConn Linguistics over other programs because I had found a community of students and professors who enjoyed each others' company regardless of field/topic of study. It is a hard task to make every student feel welcomed but I feel that I must thank, in addition to those mentioned above, Magdalena Kaufmann, Harry van der Hulst, and Marie Coppola for their contributions to such a wonderful community.

I would like to thank some of the people who started out with me: Karina Bertolino, Andrea Depetris, David Etim, Ryosuke Hattori, Roberto Petrosino, and Garrett Smith (who was wonderful as Oscar the Grouch). It was never a competition with you all and I have only made it so far because you understood my struggles better than anyone who has come before or after us. Additionally, special thanks to Oliver Sawi, you were probably my first friend in grad school and you've been one of the most supportive. And of course to Jayeon Park, thank you for the food and for the coffee. Sometimes grad school feels like just you and me against the world. My only regret was that I didn't drink more wine with you.

A girl must make a home somewhere and I was lucky enough to have shared that home with Zheng Shen, Chantale Yunt, and Nicolaus Schrum. Thank you all for putting up with my cat, Misha. Special thanks to Chantale Yunt whose company is always welcomed. I have never learned so much about myself and life as when I am talking to you.

The Linguistics community at UConn can sometimes feel ever-changing but some constants in my time here include: Pietro Cerrone, Christos Christopoulos, Shengyun Gu, Pasha Koval, Si Kai Lee, and Hiromune Oda. Thank you, Sabine Laszakovits, for being such a wonderful human being and for spending Spring Break with me in New York City. Thank you to Gabriel Martínez Vera who has been such a rational voice throughout grad school and especially this dissertation process. Thank you so much, Renato Lacerda, for the laundry + Dunkin Donut days and for all of the days in between. We did it despite it all. Thank you to Shuyan Wang, for the trips to Pho Boston after testing at the Science Center and for the Zoom work hangs. I have succeeded because of your encouragement and

belief that I would finish. And thank you to Tamara Cohen who has consistently helped me with every administrative question I've ever had. I will always have fond memories of talking in her office.

Besides advisors, I've had some kick-ass mentors in the form of older students (who have gone on to be advisors themselves!). Thank you, Laura Kalin, Aida Talić, Neda Todorović, Marcin Dadan, Lyn Tieu, Jungmin Kang, and Troy Messick. Thank you so much to Ting Xu for her words of encouragement and being a wonderful mentor. And special thanks to Helen Koulidobrova and Jean Crawford who have made every November outrageously fun with our annual BUCLD sleepover at Jean's apartment in Cambridge, MA.

Over the last eight years, I had often split my time between Linguistics and the IGERT/IBACS community which is composed of some incredible language scientists. Thank you to Paul Allopenna, Gerry Altmann, Inge-Marie Eigsti, Deanna Gagne, Chris Heffner, Jim Magnuson, Hanna Morrow, Emily Myers, Yanina Prystauka, and Whit Tabor for showing me the many ways in which we can ask questions about how language can be studied and how illuminating interdisciplinary research can be.

For making my undergraduate years at the University of Maryland fun and challenging, I'd like to thank my advisors Jeff Lidz and Valentine Hacquard for their support and guidance even now when I am no longer their student. To Colin Phillips and Dustin Chacón who are always happy to see me whenever we meet each other at UConn or at conferences. And lastly, thank you to Rachel Dudley, Megan Sutton, Alexis Wellwood, Anna Namyst, and Tania Delgado. I couldn't have asked for a more stimulating environment for a budding linguist.

My world has been all the richer for the friends that I have made attending linguistics conferences. People who have brighten every coffee break and conference dinners include Thuy Bui, Ailis Cournane, Michael Yoshitaka Erlewine, Hannah Forsythe, Ava Irani, Hadas Kotek, Victoria Mateau, Yohei Oseki, Jason Ostrove, Ayaka Sugawara, and

Dunja Veselinović. In particular, I thank Athulya Aravind and Carol-Rose Little for their friendship. And to Matt Tyler for the work hangs that were never really for work and for the beer and fries that were always really yummy.

For when Connecticut threatens to swallow me whole during one of its never-ending winters, I'd like to thank some people who remind me of home. To Charlotte Krohn for the foodie adventures and that one trip to Madrid. To Kaitlyn Kliewer for allowing me to run off to New York City whenever I needed a break from grad school. And to Case Rinard for the spontaneous yet consistent phone calls and his unwillingness to start a podcast with me. To these three people, I'm pleased that we grew up together rather than apart. To Má, BÁC, and Nam, you've supported this very independent lifestyle and odd career choice of mine with surprising understanding. This may not have been the American dream you'd envisioned for me but you had no doubt that the final outcome would be the same nonetheless.

To Alex Göbel, who believed that this project was interesting and worth pursuing even when I had doubted myself the most. This dissertation could not have been dedicated to anyone else. You have helped me gain the strength and confidence to continue on even when things looked most dire. Thank you for holding my hand and being beside me every step of the way. And thank you for proofreading this very dense dissertation from top to bottom and for putting up with my never-ending sentences with too many adjunct clauses and not enough 'however's. To my future husband, I love you.

Last but not least, people don't tell you just how lonely and stressful grad school can be sometimes. I'm happy to report that for most of my problems, my therapist, my yoga instructor, and cats were the answer. Special thanks go to Misha, Gretchen, Vincent, Henri, Nymeria, Chase, Oscar, Oliver, Wally, Frido, Moby, and Sev.

Table of Contents

	Page
Abstract	i
Acknowledgements	vi
List of Tables	xv
List of Figures	xx
Chapter	
1 The Big Three Questions	1
1.1 Introduction	1
1.2 Where Does this Dissertation Come in?	2
1.3 Outline of the Dissertation	4
2 Case Study of the English Verbal Passive	6
2.1 Introduction	6
2.2 Passives in the Adult Grammar	8
2.2.1 The Passive Form: Theoretical Background	9
2.2.2 Verbs that (Do Not) Passivize: Theoretical Background	15
2.3 Passive Constructions in Child Grammar	20
2.3.1 Passive Usage in Children	21
2.3.2 Investigations of Child English Passives	23
2.3.3 Previous Proposals	25
2.3.4 Lexical semantic features	33

2.4	Synthesis of Experimental Studies	41
2.4.1	Selection of Included Studies	42
2.4.2	Age of Acquisition (AoA)	44
2.4.3	Annotations of Lexical Semantic Features	45
2.4.4	No Single Theory Can Cover Them All.	46
2.4.5	Limitations of the synthesis of experimental studies	51
2.5	Lexical Semantic Profile Hypothesis	53
2.5.1	Lexical Semantic Profiles	53
2.5.2	Developmental Trajectory	54
2.5.3	Predictions	55
2.6	Summary	56
3	The Children’s Learning Environment	58
3.1	Introduction	58
3.1.1	Quantifying Evidence from the Input	60
3.1.2	Differentiating Input from Intake	60
3.1.3	Relationship Between Input and Acquisition	61
3.1.4	Investigating the Learning Environment for the Passive	62
3.2	Passives in Production	62
3.2.1	Passive Usage in Child-Directed Speech	63
3.2.2	Frequency-Based Hypotheses	64
3.3	Corpus Analysis of Children’s Linguistic Input	71
3.3.1	Selected Corpora for Analysis	71
3.3.2	Frequency of Passives	72
3.3.3	Examining the Developmental Trajectory of children’s Passives	73
3.4	Discussion	87
3.5	Summary	91

4	Characterizing Children’s Linguistic Behavior	93
4.1	Introduction	93
4.1.1	Lexical Semantic Profile Hypothesis	95
4.1.2	Gaps in the Empirical Coverage and the Limitations of Current Em- pirical Data	97
4.2	Experiment	98
4.2.1	Participants	98
4.2.2	Procedure	99
4.2.3	Materials	100
4.2.4	Results and discussion	104
4.2.5	Discussion	111
4.3	Summary	112
5	What Can’t Be Readily Observed: A Model of Children’s Intake for Classify- ing Passivizable Verbs	114
5.1	Introduction	114
5.1.1	Why Developmental Computational Modeling?	116
5.1.2	What Computational Modeling Can (Not) Do	116
5.1.3	The Passive Lexical Verb Asymmetry as a Classification Problem . .	117
5.2	Bayesian Modeling	119
5.2.1	Bayes’ Theorem and its Basic Components	119
5.3	Using Bayesian Modeling to Understand the Passive Lexical Verb Asymmetry	121
5.3.1	Nature of the Learning Task	121
5.3.2	Adapting Bayes’ Theorem for Classifying Passivizable Verbs	122
5.3.3	Empirical Data on Children’s Passives	124
5.4	Where Do the Numbers Come From?	126
5.4.1	Estimating Likelihood Probabilities	126
5.4.2	Estimating Prior Probabilities	127

5.4.3	Selective Use of Lexical Features	129
5.5	Evaluating Model Success	131
5.6	Model Comparisons and Connections to Passive Behavior in 5-Year-Old Children	132
5.7	Discussion	134
5.7.1	Interpreting the Passivization Prior	134
5.7.2	Predictions and Consequences	135
5.8	Summary	139
6	Relying on Lexical Features to Classify Novel Passivizable Verbs	141
6.1	Introduction	141
6.2	Experiment	143
6.2.1	Participants	143
6.2.2	Method	144
6.2.3	Results	153
6.3	Discussion	160
6.4	Summary	163
7	Wrapping Up	165
7.1	Summary of Findings	165
7.2	Theoretical & Developmental Implications	167
7.2.1	Previous Theoretical Proposals	167
7.2.2	Status of Lexical Features	167
7.3	Future Work	170
7.3.1	The Passive of OBJECT-EXPERIENCERS	170
7.3.2	Short Passives	171
7.3.3	Cross-Linguistic Acquisition	171
7.4	Conclusion	173

Appendix	174
A.1 Summaries of studies used in the synthesis of experimental studies	174
A.2 List of verbs used in passive voice in child-directed speech	182
A.3 Materials used in the Truth-Value Judgment Task	183
A.4 256 models of filtered input on the basis of eight lexical features with 1 indi- cating the feature is heeded and 0 indicating the feature is not	188
A.5 Materials used in the Novel Verb Learning Study	195
Bibliography	195

List of Tables

Table	Page
2.1 Percent correct responses to a picture selection task testing active and passive sentences (Maratsos et al. 1985: 180).	34
2.2 Percentage of correctly acted out items in comprehension task (Pinker et al. 1987: 223).	36
2.3 Frequency of correct and incorrect match response by verb type and structure (Messenger et al. 2012: 581).	39
2.4 Descriptive lexical semantic features derived from prior experimental studies, including signals of that feature and example verbs with (+) and without (-) that feature.	40
2.5 Studies, methodologies, and verbs used in the synthesis of experimental studies.	43
2.6 AoA of verbs from the synthesis of experimental studies, representing an AoA by 3 years old (3yr), between 3 and 4 years old (3-4yr), between 4 and 5 years old (4-5yr), and 5 years old (5yr).	45
2.7 Example reasoning for identification of lexical semantic features in the verbs <i>find</i> , <i>carry</i> , and <i>love</i>	46
2.8 Lexical semantic annotations for the 30 verbs that have a derivable AoA from the synthesis of experimental studies. Double lines indicate a difference in the featural pattern within each age group.	47
2.9 Example predictions of children’s performance on the passives of <i>carry</i> , <i>search</i> , <i>annoy</i> , and <i>love</i> by each lexical semantic proposal.	51
2.10 Lexical semantic profiles comprised of the seven lexical semantic features for example verbs with different experimentally observed ages of acquisition (AoA).	54

2.11	Observed age of acquisition (AoA) for the 30 verbs with an AoA available from the synthesis of experimental studies, along with their lexical semantic profile (Profile).	55
2.12	AoA predictions (Predicted AoA) for example verbs in English, based on their lexical semantic profiles (Profile).	55
3.1	Summary of corpora used, including the total number of child-directed speech (CDS) utterances extracted for analysis.	71
3.2	AoA of verbs from the synthesis of experimental studies, representing an AoA by 3 years old (3yr), between 3 and 4 years old (3-4yr), between 4 and 5 years old (4-5yr), and 5 years old (5yr).	73
3.3	Individual verb frequencies for the 30 verbs in children’s input that had an observed age of acquisition (AoA), sorted by the frequency of their passive use in children’s input.	74
3.4	Distribution (in raw counts) of lexical features from child-directed speech, including frequencies of passive, active, and overall use.	79
3.5	Distribution (represented as proportions) of lexical features in child-directed passive utterances for verb type (out of 116).	82
3.6	Distribution (represented as proportions) of lexical features in child-directed passive utterances for verb token (out of 361).	82
3.7	Lexical semantic profiles comprised of the seven lexical semantic features for example verbs with different experimentally observed ages of acquisition (AoA).	84
3.8	Distribution (in raw counts) of lexical semantic profiles from child-directed speech, including frequencies of overall, passive, and active use.	85
3.9	Distribution (represented as proportions) of lexical semantic profiles in child-directed passive utterances for verb type (out of 116) including earliest reported age of acquisition (AoA).	85





3.10	Distribution (represented as proportions) of lexical semantic profiles in child-directed passive utterances for verb token (out of 361) including earliest reported age of acquisition (AoA).	86
3.11	Distribution (represented as proportions) of lexical features in child-directed passive utterances for verb type (out of 116).	87
3.12	Distribution (represented as proportions) of lexical features in child-directed passive utterances for verb token (out of 361).	88
3.13	Distribution (represented as proportions) of lexical features in child-directed passive utterances for verb type up to 4yr.	88
3.14	Distribution (represented as proportions) of lexical features in child-directed passive utterances for verb token up to 4yr.	88
3.15	Distribution (represented as proportions) of lexical features in child-directed passive utterances for verb type up to 3yr.	89
3.16	Distribution (represented as proportions) of lexical features in child-directed passive utterances for verb token up to 3yr.	89
4.1	Lexical semantic profiles comprised of the seven lexical features for example verbs with different experimentally observed ages of acquisition (AoA).	96
4.2	AoA predictions (Predicted AoA) for example verbs in English, based on their lexical semantic profiles (Profile).	96
4.3	Lexical profiles of the 10 verbs tested and the two lists that these verbs were split into, along with their predicted age of acquisition (Predicted AoA) in English, according to the LEXICAL SEMANTIC PROFILE HYPOTHESIS.	101
4.4	Accuracy rates for adults and four-year-olds by verb profile, compared to chance (50%).	105
5.1	Descriptive features derived from prior experimental studies, including example verbs with (1) and without (0) that feature.	125

5.2	Profiles for example verbs (in <i>italics</i>) with an observed AoA by age five. Profiles are comprised of lexical semantic and syntactic features, with 1 indicating the verb is <i>+feature</i> and 0 indicating the verb is <i>-feature</i>	126
5.3	Likelihood probabilities for individual features, calculated from child-directed speech input, for verbs in the passive ($P(v_{fi} +pass)$, left) and active voice ($P(v_{fi} -pass)$, right).	127
5.4	Calculation of the likelihood probability (l_{pass}) and the prior probability ($P(+pass)$) for <i>annoy</i> , given the likelihood probabilities of its feature profile. The likelihood ratio indicates the minimum <i>+pass</i> prior probability could be and still allow passivization for the profile of the verb <i>annoy</i>	129
5.5	Calculation of the likelihood probability (l_{pass}) and the prior probability ($P(+pass)$) for the verb <i>annoy</i> if only the features ACTIONAL and TRANSITIVE (TRANS) were attended to. The likelihood ratio indicates the minimum the <i>+pass</i> prior probability could be and still allow passivization for the profile of the verb <i>annoy</i>	131
5.6	The minimum priors on the passive structure required to yield five-year-old passivization behavior for the five lexical profiles of interest, when all features are heeded. Priors below 0.50 are in bold	133
5.7	Successful input filters that yield minimum priors on passivization below 0.50 and still generate five-year-old passivization behavior for the five lexical profiles of interest, given different collections of features to selectively attend to.	134
6.1	Number of participants and mean age of the child participants broken down into three age groups.	144
6.2	Lexical profiles of the 10 novel verbs as a combination of TRANSITIVITY (TRANS), STATIVITY (STAT), AFFECTEDNESS (AFFECT), and Object-Experiencer (OBJ-EXP) and close approximates of their semantic categories.	149

6.3	The meanings of the 10 novel verbs taught to participants along with their close linguistic counterparts	149
6.4	Example script of audio for <i>doak</i> (+TRANS, -STATIVE, -AFFECT)	150
6.5	Example script of audio for <i>pell</i> (+TRANS, -STATIVE, +AFFECT)	150
6.6	Example script of audio for <i>blick</i> (+TRANS, +STATIVE, +AFFECT)	150
6.7	Example script of audio for <i>gorp</i> (+TRANS, +STATIVE, -AFFECT)	151
6.8	Example script of audio for <i>floose</i> (-TRANS, -STATIVE, +AFFECT)	151
6.9	Performance by each age group for each verb class as compared to chance (50%).	159
2	Example script of audio for <i>doak</i> (+TRANS, -STATIVE, -AFFECT)	195
3	Example script of audio for <i>pilk</i> (+TRANS, -STATIVE, -AFFECT)	195
4	Example script of audio for <i>pell</i> (+TRANS, -STATIVE, +AFFECT)	195
5	Example script of audio for <i>gump</i> (+TRANS, -STATIVE, +AFFECT)	196
6	Example script of audio for <i>blick</i> (+TRANS, +STATIVE, +AFFECT)	196
7	Example script of audio for <i>moop</i> (+TRANS, +STATIVE, +AFFECT)	196
8	Example script of audio for <i>gorp</i> (+TRANS, +STATIVE, -AFFECT)	196
9	Example script of audio for <i>keat</i> (+TRANS, +STATIVE, -AFFECT)	197
10	Example script of audio for <i>floose</i> (-TRANS, -STATIVE, +AFFECT)	197
11	Example script of audio for <i>jape</i> (-TRANS, -STATIVE, +AFFECT)	197

List of Figures

Figure	Page
2.1 An illustration of smuggling for <i>The book was written by John</i> from Hyams and Snyder (2006) (cf. Collins 2005b: 90, 95).	12
2.2 A syntactic illustration of the passive as proposed by Grillo (2008) and Gehrke and Grillo (2009).	14
2.3 Predictions by Theory - ACTIONALITY across AoA (Maratsos et al., 1985). Dashed line demarcates the predicted boundary in children’s behavioral performance. Verbs in green are predicted to be earlier than verbs in red.	48
2.4 Predictions by Theory - AFFECTEDNESS across AoA (Pinker et al., 1987). Dotted line demarcates the predicted boundary in children’s behavioral performance. Verbs in green are predicted to be earlier than verbs in red.	49
2.5 Predictions by Theory - STATIVITY & VOLITIONALITY across AoA (Liter et al., 2015). Solid line demarcates the predicted boundary in children’s behavioral performance. Verbs in green are predicted to be earlier than verbs in blue and verbs in red. Verbs in grey are unaccounted for by the theory.	50
2.6 Predictions by Theory - Thematic Role Relations across AoA (Messenger et al., 2012). Solid line demarcates the predicted boundary in children’s behavioral performance. Verbs in green are predicted to be earlier than verbs in red.	50
2.7 Predictions by All Theories.	51
3.1 Age of acquisition (AoA) by passive use frequency.	76
3.2 Age of acquisition (AoA) by individual verb frequency	76
4.1 Percentage of correct responses by verb profile for adult controls. (Error bars indicate standard error.)	104

4.2	Percentage of correct responses by verb profile for four-year-olds. (Error bars indicate standard error.)	105
4.3	Distribution of accuracy rates by verb profile for four-year-olds.	105
4.4	Percentage of correct responses for passive items by verb for four-year-olds. (Error bars indicate standard errors.)	109
6.1	An example from the training phase where the target answer is the first picture from the left. Participants were always shown three pictures where the first two pictures depict real scenes and the third picture is always a red 	146
6.2	An example from the training phase where the target answer is the third picture from the left containing the red 	146
6.3	An example from the training phase where participants were introduced to aliens that would later appear in the experiment. Participants were told that these aliens were naturally blue (left) but could change colors externally depending on the feelings of their aliens (right).	147
6.4	Procedure of an example novel verb, <i>moop</i>	148
6.5	An example of a test item in the <i>floose</i> condition.	152
6.6	An example of a test item in the <i>moop</i> condition.	153
6.7	Percentage of Correct Responses by verb class: Adults (Since red  was never chosen, chance is set at 50%)	154
6.8	Distribution of Accuracy Rates of the four TRANSITIVE Novel Verb Classes for adult participants (N=33).	155
6.9	Distribution of Answer Types for the Transitive Novel Verb Classes for all child participants (N=57).	156
6.10	Percentage of Correct Responses by verb class: Children (Since red  was almost never chosen, chance is set at 50%)	157
6.11	Percentage of correct responses by 4-year-old participants (N=5) broken down by novel verb class.	157

6.12	Percentage of correct responses by 5-year-old participants (N=8) broken down by novel verb class.	158
6.13	Percentage of correct responses by child participants 6 years and older (N=44) broken down by novel verb class.	158
6.14	Distribution of answer types for the -TRANSITIVE novel verb classes for all child participants (N=57).	161

1 | The Big Three Questions

1.1 Introduction

One of the most daunting tasks for a child is navigating through her language environment in an effort to successfully acquire a grammar that mirrors that of her language community. But while children reach this adult target state at a remarkably rapid rate, the developmental path taken is not a direct reflection of the child's input. That is, there is often a mismatch between the evidence that is available to children and what children are able to show they know about their native language. In order to fully understand the acquisition process, language scientists are interested in answering three questions:

- Q1** What kinds of evidence are available to children in their input? How much evidence of various types are children receiving?
- Q2** What is the nature of children's linguistic knowledge and their capacity to deploy that knowledge during the course of development?
- Q3** What is a precise theory of how children harness evidence from their input to acquire sophisticated linguistic knowledge?

Thus, a full investigation into how children successfully learn language requires a framework consisting of three components: (i) fine-grained analyses of the input that is available to children, (ii) experimental studies of children's linguistic behavior at different periods of development, and (iii) computationally-explicit learning theory that capture the process of how children integrate their knowledge and input.

1.2 Where Does this Dissertation Come in?

One clear example of a mismatch between children’s behavior and their learning environment is the development of the English verbal *be*-passive (henceforth “verbal passive”). On the surface, a verbal passive such as that in (1.1) is understood as being in syntactic alternation with its active counterpart in (1.2). On this view, acquiring the verbal passive would simply require the structural knowledge of how the verbal passive is different from its active form. However, it seems that lexical meaning plays a crucial role in the development of these passives. Specifically, while (almost) every verb can readily be used in the active voice, this is not the case for passives; the set of passivizable verbs that children must learn is subject to cross-linguistic variation (Keenan and Dryer, 1981). For example, Vietnamese allows the passivization of intransitive verbs like *vomit* as in (1.4) in contrast to English (i.e., **Nam was vomited* under the reading where Nam is suffering from bouts of vomiting). Furthermore, Vietnamese verbal passives also differ from English verbal passives in its syntactic form; while Vietnamese uses unique passive morphemes (i.e., *được* as in (1.3) and *bị* as in (1.4)) to signal a verbal passive, English verbal passives are signaled by a change in the verbal morphology, a promotion of the deep object to surface subject position, and (sometimes) the addition of a *by*-phrase containing the deep subject of the sentence. Thus, in addition to acquiring the syntactic form of verbal passives, a child must also learn which verbs are (un-)available in the verbal passive in the language that she is learning.

(1.1) Tom was hugged by Lucy.

(1.2) Lucy hugged Tom.

(1.3) Nam được Huyền ôm.

Nam PASS Huyen hug

‘Nam was hugged by Huyen.’

(1.4) Nam bị ói.

Nam PASS vomit

‘Nam was vomited’ as in Nam is suffering from bouts of vomiting

It has been observed that English-speaking children seem to be delayed in their understanding of verbal passives despite hearing some passives (of any kind) in their input (Gordon and Chafetz, 1990). This delay in understanding has often been attributed to a non-adult-like linguistic representation of the grammatical structure of verbal passives in young children’s grammars (Borer and Wexler, 1987, 1992; Fox and Grodzinsky, 1998; Snyder and Hyams, 2015, a.o.). Furthermore, it has been observed that there is an interaction between the lexical characteristics of a verb and children’s performance on tests using that verb in the verbal passive (Maratsos et al., 1985). For example, verbal passives with verbs like *hug* (1.1) have been claimed to be easier for young English-speaking children than verbal passives with verbs like *love* (1.5), even though English-speaking adults allow both (1.1) and (1.5). I will refer to this interaction between children’s linguistic behavior in comprehension studies and the lexical features of the verb being tested as the (PASSIVE) LEXICAL VERB ASYMMETRY in children’s development of the English verbal passive.

(1.5) Tom was loved by Lucy.

Most of the research investigating the source of this passive lexical verb asymmetry has been focused on when English-speaking children are adult-like in their structural representation of the verbal passive (Borer and Wexler, 1987, 1992; Fox and Grodzinsky, 1998; Hyams and Snyder, 2006; Snyder and Hyams, 2015). Much less work has been done to characterize how and why children’s linguistic behavior on verbal passives is affected by a verb’s lexical characteristics (Liter et al., 2015; Liter and Lidz, 2020; O’Brien et al., 2006; Messenger et al., 2012; Pinker et al., 1987; Pinker, 1989) (see Chapters 2 and 3 for a more thorough review of previous research on the passive lexical verb asymmetry). Moreover,

no work so far has been done attempting to provide explicit computational models of how children learn from their input which verbs participate in the active-/passive-voice alternation, i.e., which verbs are (un-)passivizable in their native language. It is the goal of this dissertation to investigate the development of the English verbal passive, particularly the question of how children learn the set of passivizable verbs in English, by conducting research designed around answering the three questions outlined above.

1.3 Outline of the Dissertation

In this dissertation, I investigate how children exploit lexical information in order to understand the English verbal passive and how the passive lexical verb asymmetry observed in children is a consequence of this process. I achieve this goal by conducting research designed around answering the three central questions of language acquisition outlined above. I will begin by characterizing the input that is available to children with regards to the verbal passive – **Q1**. I will then provide evidence from behavioral studies addressing how we should characterize children’s linguistic knowledge of the passive – **Q2**. After establishing what scientists can readily observe, i.e., children’s input and linguistic behavior, which serve as the input and endpoint of a developmental model, I will provide an explicit computational model that sketches how children might harness linguistic evidence from their input to arrive at their observed linguistic behavior – **Q3**. This developmental model provides predictions regarding children’s linguistic behavior in experimental contexts where input can be tightly controlled, which is the final goal of this dissertation.

The rest of the dissertation is organized in the following way: In Chapter 2, I introduce the case study of passives and discuss previous research on the acquisition of verbal passives in English and how lexical features can play a pivotal role in explaining children’s understanding of verbal passives. In Chapter 3, I present a corpus study on the relationship between children’s age of acquiring a verb in the verbal passive and the linguistic input that is available to them. In Chapter 4, I present a behavioral study in which I test

whether linguistic behavior within a group of children can be predicted by a verb's lexical feature makeup. In Chapter 5, I model the developmental trajectory that we've seen in Chapters 2 and 3 via a naive Bayesian learner to explore an acquisition story where children are impacted by lexical features. In Chapter 6, I present a behavioral study on how children deal with the passivization of novel (i.e., nonce) verbs with different lexical feature makeups in an experimental context in which children's linguistic input is tightly controlled. Specifically, I test children's reliance on particular lexical features as predicted by the computational model developed in the previous chapter. In Chapter 7, I discuss directions for future work and conclude the dissertation by underscoring the importance of considering lexical semantic features when investigating the development of syntactic knowledge.

2 | Case Study of the English Verbal

Passive¹

2.1 Introduction

The English verbal passive is an interesting case study because young children exhibit a well-documented passive lexical verb asymmetry (henceforth *lexical asymmetry*) in their linguistic behavior in comprehension studies. These studies find that children’s understanding of verbs in the verbal passive is more delayed for some verbs than it is for others. So while English-speaking children seem to understand long verbal passives containing an ACTIONAL verb, as in (2.1), around age 4 or 5 (Bever, 1970; Horgan, 1978; de Villiers and de Villiers, 1973), it has been reported that they do not demonstrate adult-level comprehension of long verbal passives containing a non-ACTIONAL verb, as in (2.2), until age 7 (Gordon and Chafetz, 1990; Maratsos et al., 1985; Hirsch and Wexler, 2006).^{2,3,4} Here, a verb is deemed to be ACTIONAL when it is generally observable as an event while a non-ACTIONAL verb would generally be unobservable (Maratsos et al., 1985). So, while *hug* is

¹The synthesis of experimental studies described in this chapter was work that I conducted while visiting the University of California, Irvine, under the supervision of Lisa Pearl in Spring 2016. This research has been presented at the following workshops and conferences: Computational Language Acquisition (CoLa) Laboratory at UCI, Experimental Syntax and Semantics Lab at MIT, Workshop on Passives at the University of Geneva, Linguistic Society of America Annual Meeting (LSA Annual Meeting 2017), and Chicago Linguistic Society (CLS 53). Parts of this chapter is based on Nguyen and Pearl (2018, 2021).

²For the rest of the dissertation, direct references to specific lexical features will be marked in SMALL CAPS and specific verbs in *italics* (e.g., ACTIONAL, *hug*, respectively).

³“Long” passives refer to those including the presence of a *by*-phrase which contains the deep subject of the active form of the sentence (e.g., *by Connell* in (2.1)). This *by*-phrase is optional in English and may be omitted to form a “short” passive as in (i).

(i) Marianne was hugged.

⁴Children’s difficulty with passives (especially with non-ACTIONAL verbs) has also been shown cross-linguistically for German (Bartke, 2004), Dutch (Verrips, 1996), Spanish (Pierce, 1992), Russian (Babyonyshev and Brun, 2003), among others. See Chapter 7 for a fuller discussion.

an event that we can witness happening, *love* describes an event that happens internally to the participants and thus is unobservable.

(2.1) Marianne was hugged by Connell.

(2.2) Marianne was loved by Connell.

The acquisition of verbal passives (assumed here to involve movement of an object from one argument position to another argument, namely the subject position) has long been considered to be delayed in English-speaking children when compared to other types of object movement. So while studies have shown English-speaking children to have early knowledge of object movement in unaccusatives, object questions, and object relatives by their third birthday (Costa and Friedmann, 2012; Guasti, 2017; Snyder et al., 1995; Snyder and Stromswold, 1997; Gagliardi et al., 2016; Perkins and Lidz, 2020), they do not seem to exhibit stable mastery of verbal passives with all verb types until well after six years of age.⁵ Full mastery of verbal passives is defined as the ability to understand the passive of all of the verbs that can indeed passivize in a given language, and to reject the passive of verbs that cannot passivize.⁶ Thus, the development of the verbal passive will require children to acquire two pieces of knowledge: (i) the syntactic operations or representations involved with generating the verbal passive, (ii) the set of verbs that are passivizable

⁵With regards to relative clauses, an often-discussed finding in the literature is the asymmetry in the production and comprehension of subject and object relatives in adults and children, where object relatives are more difficult and mastered later than subject relatives (e.g., Friederici et al., 1998; Booth et al., 2000). Researchers have shown that children have early knowledge of the structural representation of object relatives and that non-adult-like performance in children may be a consequence of processing difficulties (see Guasti (2017) and Perkins and Lidz (2020) for more discussion). What is notable here is that English-speaking children's knowledge of the structural representation of object relatives is assumed to be mastered earlier than verbal passives.

⁶This is perhaps a high bar to set for characterizing acquisition. To my knowledge, the same standards have not been applied to other language learning problems (e.g., the acquisition of unaccusatives where the set of unaccusative verbs is demonstrably smaller than the set of passivizable verbs). On a practical level, it is often the case that children are determined to have *adult-like* knowledge for a particular learning problem when their *behavior* on a representative (but sometimes arbitrary) set of verbs in a particular experiment is comparable to how adults would behave. Full mastery in the way that I have defined it is assumed to occur over time as children are acquiring more verbs in their native language but are fully able to classify a new verb as passivizable or not based on certain properties/features of the verb.

in their target language.

In order to understand how children may come to know these two pieces of linguistic knowledge, we must first understand what the end state that children are trying to achieve is — that is, what is the target adult state. We then need to investigate whether children go through multiple stages of development before arriving at this end state. To that end, this chapter will be divided into three sections.⁷ I will first present a brief overview of how the syntax of passives can be represented in the adult grammar as discussed in the theoretical literature and how the lexical restrictions on which verbs can passivize differ cross-linguistically. I will then present an overview of previous work on children’s knowledge of passives, including details about several potentially relevant lexical semantic features that have been proposed in the literature to affect children’s performance on the verbal passive. And finally, I will describe a synthesis of experimental studies on children’s comprehension of the English verbal passive which will allow us to describe the passive lexical asymmetry in better detail. I will discuss how no proposed lexical feature on its own can explain children’s observed linguistic behavior and suggest that we should instead examine the data through the lens of combining these lexical semantic features into groupings.

2.2 Passives in the Adult Grammar

In generative grammar, English verbal passives are generally agreed to involve some form of movement of the direct object away from its base-generated position. Cross-linguistically, there are many observed differences in how passives are structured syntactically and in the set of verbs that are allowed to passivize.

⁷Since the focus of this dissertation is on English verbal passives and English-speaking children’s development, the bulk of the discussion will be focused on English. I will also include some discussion of how passives are represented cross-linguistically but will save most of this discussion for Chapter 7 when I discuss how the developmental story proposed for English-speaking children can be extended cross-linguistically.

2.2.1 The Passive Form: Theoretical Background

In English, most transitive verbs participate in an alternation between active and passive voice. The active sentences for these passivizable verbs often have an Agent or Experiencer argument in the subject position and a Patient or Theme argument in the object position, respectively. In the case of (2.3), Marianne receives the Agent theta role of *hug* and appears in the subject position and Connell receives the Patient theta role and appears in the direct object position. (2.3) has the interpretation that Marianne is the ‘hugger’ and it is Connell who is receiving the hug. For the verb *love* in (2.4), Marianne receives the Experiencer theta role and appears in the subject position, while Connell receives the Theme theta role and appears in the direct object position. Additionally, there exists verbs in which the Experiencer and Theme theta roles are reversed as is the case for the verb *annoy* in (2.5). Here, the Theme theta role is given to Marianne in the subject position while the Experiencer theta role is given to Connell in the direct object position.

(2.3) Marianne hugged Connell. (Marianne = Agent, Connell = Patient)

(2.4) Marianne loved Connell. (Marianne = Experiencer, Connell = Theme)

(2.5) Marianne annoyed Connell. (Marianne = Theme, Connell = Experiencer)

While maintaining more or less the same meaning, the passivization of (2.3), as in (2.6), reorganizes the arguments by inverting their positions so that the Patient, *Connell*, now appears in the subject position and the Agent, *Marianne*, appears in a prepositional phrase introduced by the preposition *by* (henceforth ‘*by*-phrase’). Since the days of Transformational Grammar, Chomsky (1957, 1965, 1981) proposed that the surface level differences between active and passive sentences were due to operations of syntactic movement imposed on the active to form the passive. These passive transformations included: (i) the raising of the verb’s internal argument to the (syntactic) subject position, whereby an argument chain (A-chain) was formed between this position and the trace that is left behind

in the base-generated position; and (ii) the demotion of the external argument (the logical subject) to the *by*-phrase (for reviews, see Haegeman, 1994; Chomsky, 1995). It is important to note that this latter surface realization of the external argument is optional in English as it is perfectly acceptable to leave out the *by*-phrase, as in (2.7), when describing the same event. Verbal passives with *by*-phrases have been called “long passives” in the literature while verbal passives without *by*-phrases have been called “short passives”. Apart from this transformation, passives also differ from their active counterparts in the presence of particular morphological markings: in English, passives are additionally marked with a passive auxiliary verb (i.e., *be* or *get*) and participial inflection on the main verb (either as *-ed* for *hug* in (2.6)-(2.7) or *-en* plus ablaut for *break* in (2.8)).

(2.6) Connell was hugged by Marianne.

(2.7) Connell was hugged.

(2.8) The vase was broken by Marianne.

The inversion of identical theta roles between (2.3) and (2.6) has been taken as evidence that an active sentence and its passive counterpart share the same deep structure, in accordance with the Uniformity of Theta Assignment Hypothesis (UTAH) (Baker, 1988), which states that identical thematic relationships between sentences are represented by the same structural relationships at deep structure.

With the demotion of the logical subject – the external argument of the verb in the deep structure – to an optional *by*-phrase, Jaeggli (1986) and Baker et al. (1989) have proposed that the passive participle *-en* serves as the external argument (in the technical sense) and “absorbs” both accusative case and the external theta role (Collins, 2005b; Alexiadou et al., 2018). Following Burzio’s Generalization, the verb in the passive will no longer be able to assign structural accusative case, which poses a problem because the internal argument needs case (Burzio, 1981). Thus, the logical object is required to move to the subject po-

sition, where it receives nominative case (Chomsky, 1981; Levin and Rappaport, 1986). As for the logical subject in long passives, it has been argued that the passive participle *-en* transmits the “absorbed” external theta role to the *by*-phrase via a mechanism called “theta-role transmission” (Jaeggli, 1986). Evidence for this comes from sentences (2.9)-(2.12) where the interpretation of the *by*-phrases is not limited to a single theta-role; rather, the theta-role is assigned by the verb. Thus, the logical subject in these *by*-phrases receives the same theta-role as the surface subject in the active counterparts.

- (2.9) Marianne was carried by Connell. (Agent)
- (2.10) The package was sent by Connell. (source)
- (2.11) The letter was received by Marinne. (goal)
- (2.12) That professor was loved by all students. (Experiencer)

(modified from Jaeggli 1986:599)

In more recent years, Collins (2005b) has argued that the proposed non-uniformity of external theta-role assignment in the active and the passive (i.e., to a DP versus a verbal affix) would constitute a violation of Baker’s (1988) UTAH. To remedy this, Collins has proposed that the external theta-role is always assigned in the canonical subject position, Spec,*v*P, in both the active and in the passive. The preposition *by* is now the head of VoiceP, which is merged directly above *v*P, and checks accusative case for the verb. But maintaining UTAH under Collins’s proposal would require the movement of the internal argument, which is base-generated as the sister of the verb, over the external argument into its final Spec,IP, position. This movement would violate the Minimal Link Condition (see Chomsky, 2000) as well as Relativized Minimality (Rizzi, 1990, 2001, 2004; Grillo, 2008).^{8,9} Collins’ solution to this movement problem is to “smuggle” the internal argu-

⁸Minimal Link Condition: A node X may not AGREE with a DP Y if there is a DP Z such that X c-commands Z and Z c-commands Y.

⁹Rizzi (2004) argued that argumental (e.g., PERSON-NUMBER-GENDER), quantificational (e.g., WH and

ment past the verb's external argument. A definition of smuggling is given in (2.13). The smuggled internal argument will then become the closest argument to Spec, IP, which allows it to assume the role of subject without any violation of Relativized Minimality. The assumed derivation of (2.13) is illustrated in Figure 2.1.

(2.13) Smuggling (Collins, 2005a):

Suppose a constituent YP contains XP. Furthermore, XP is inaccessible to Z because of the presence of W, some kind of intervener that blocks any syntactic relation between Z and XP. If YP moves to a position c-commanding W, we say that YP smuggles XP past W.

Figure 2.1: An illustration of smuggling for *The book was written by John* from Hyams and Snyder (2006) (cf. Collins 2005b: 90, 95).

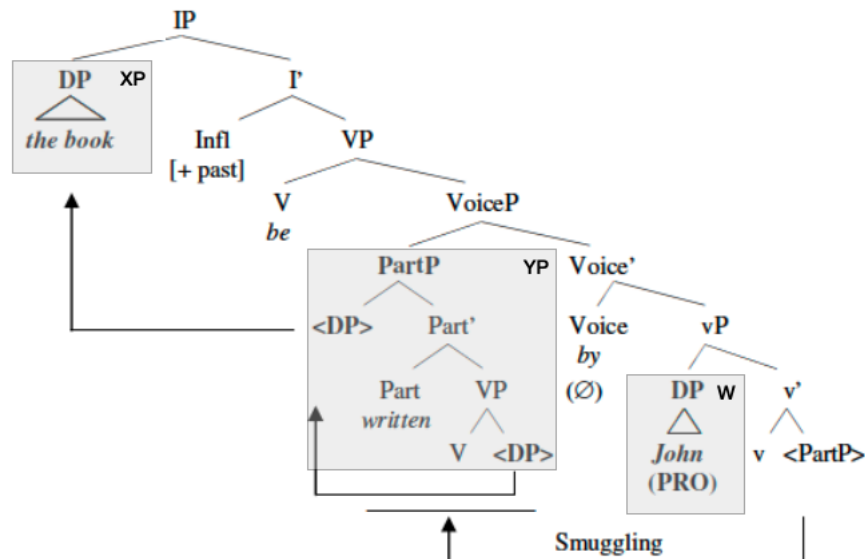

While major theories of the syntactic representation of the passive up until this point in the discussion viewed passives as an operation on argument structure where the internal

FOCUS), and modificational features, as well as the TOPIC feature (taken as being separate from the others), constitute four different natural classes. He proposes that Relativized Minimality, defined below, operates in terms of these four 'structural types'.

(i) Relativized Minimality:

In ...X...Z...Y, a local relation cannot hold between X and Y if Z belongs to the same structural type as X.

argument is forced to move to subject position in the passive in order to receive case, [Grillo \(2008\)](#) and [Gehrke and Grillo \(2009\)](#) proposed that passivization is instead an operation on the event structure of structurally complex predicates containing STATIVE subevents. This proposal is based on [Travis's \(2000\)](#) theory of event structure in which an EVENTIVE predicate has a VP₁ (as in (2.2)) shell that expresses a “causing” sub-event (e.g., *Mari- anne causes the vase to become broken* in (2.8)) and introduces the external argument. V₁ selects a VP₂ expressing a “consequent” sub-event (or sub-eventuality, if the predicate is STATIVE), which hosts the internal argument. Keeping some of the technical details of [Collins's \(2005b\)](#) smuggling approach, [Grillo \(2008\)](#) and [Gehrke and Grillo \(2009\)](#) propose that VP₂ can smuggle the internal argument in the passive past the external argument to a position above the subject, as illustrated in (2.2). However, rather than moving for reasons of case assignment, they argue that this movement is to a discourse-related position at the edge of the verb phrase and happens for discourse and quantificational reasons. Drawing on [Rizzi's \(2004\)](#) featural classes (see footnote 9), [Gehrke and Grillo](#) propose that a scope/discourse-related feature on the internal argument, like TOPIC, drives movement of the VP₂ over the external argument to a projection containing discourse properties. The discourse-related feature on VP₂ allows the system to distinguish the internal argument from the external argument and avoid minimality effects in standard passives. By shifting focus to event structure, the movement of the internal argument is semantically, rather than syntactically, motivated in addition to the possibility that the lexical meaning of a predicate may matter in whether the predicate allows passivization.

For predicates that are STATIVE and thus may not have an internal event structure or VP-shell structure as described above, [Grillo \(2008\)](#) and [Gehrke and Grillo \(2009\)](#) propose that these predicates can still be passivized through a mechanism called “semantic coercion”. Specifically, STATIVE predicates can be “coerced” into having a related, eventive meaning and thereby have a similar enough event structure to EVENTIVE predicates in order for smuggling to take place. For example, a STATIVE predicate such as *to own* in (2.14)

Figure 2.2: A syntactic illustration of the passive as proposed by Grillo (2008) and Gehrke and Grillo (2009).

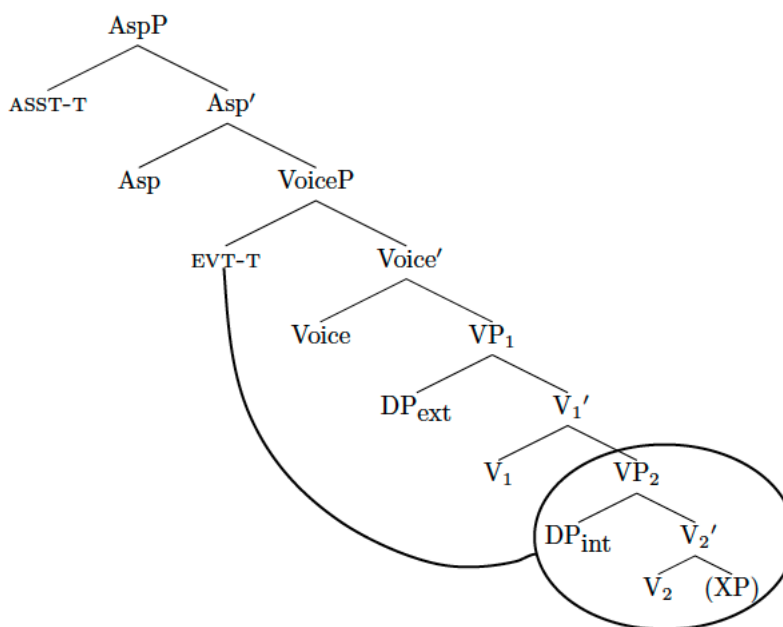

can be reconceptualized as the consequent of an event, e.g., as a gain of home-ownership. This new coerced meaning can give rise to an event structure that will allow for smuggling and thus passivization.

- (2.14) Marianne owns that house → That house was owned by Marianne.
 ≈ Marianne has gained ownership of that house.

There is an ongoing debate regarding the finer details of how the passive is structurally formed, but as noted by Alexiadou et al. (2018), every syntactic theory of the English passive (and English-like passives that appear cross-linguistically) must capture three basic observations: (i) almost every transitive verb can passivize, (ii) active and passive sentences differ in the word order (as well as corresponding case/agreement morphology), and (iii) verbal passives come with a particular morphological marking (e.g., the passive auxiliary and the participle in English).

Of particular interest to this dissertation is the first basic observation – that almost

every transitive verb participates in the active/passive alternation in English. In the next section, I will go into more detail about which verbs can (not) passivize in English, why this may be the case, and how the set of passivizable verbs is subject to cross-linguistic differences.

2.2.2 Verbs that (Do Not) Passivize: Theoretical Background

As noted before, the types of predicates that allow passivization are subject to cross-linguistic variation. In other words, verbs that passivize in one language may not passivize in another. As part of the learning problem, a child must not only learn the structural form of the passive in her language, but which verbs participate in the active/passive alternation as well. Given a basic description of the verbal passive in English where a verb's internal argument is promoted to subject position and the external argument is demoted to an optional *by*-phrase, it may be unsurprising that intransitive verbs (i.e., verbs that do not have an internal argument like *laugh* in (2.15)) do not allow passivization.¹⁰

(2.15) *Marianne was laughed by Connell's friends.

Thus, all passivizable verbs in English will be transitive verbs that have both an internal and external argument. But while all passivizable verbs are transitive verbs in English, not all transitive verbs allow passivization (Pinker et al., 1987; Pinker, 1989).

- (2.16) a. *Three bicycles are had by Marianne.¹¹
b. *210 pounds are weighed by Connell.
c. The bucket was kicked by King George. (*under the idiomatic reading)

¹⁰There are some intransitive verbs in English that can participate in a pseudo-passive form. These constructions add a post-verbal preposition to create a complex verbal predicate that may look like a verbal passive on the surface. So (2.15) could be made better with *laughed+at* as in (i).

(i) Marianne was laughed at by Connell's friends.

¹¹*To have* also has an idiomatic meaning to mean *to cheat*, which can passivize, e.g., *You've been had by the shop keeper who sold you \$100 flip-flops*. This suggests that the ability to passivize rests upon the lexical meaning of the verb or possibly on its specific lexical entry.

- d. *One hundred dollars are cost by this iPad.
- e. *Many people are escaped by the argument.
- f. *Many changes will be seen by the coming decade.
- g. *A deadly poison is contained by this bottle.
- h. *Huyen is resembled by Nam.

(modified from [Pinker et al. 1987](#): 197)

[Pinker \(1989: 135\)](#) suggests that at the very least all transitive verbs that “clearly have Agents and Patients” allow passivization in English. But for verbs that do not have Patients as their objects or Agents as their subjects, Pinker notes that the distinction between those that do and do not passivize is not readily obvious and that there is “no theory that demarcates these boundaries fully” and thus it is unclear what syntactic reasons there may be for these verbs to not allow passivization. For example, pairs of psychological verbs where the objects are allowed to be either the Experiencer or the Theme are allowed to passivize (e.g., *fear* in (2.17a), *frighten* in (2.17b)), as are EVENTIVE verbs with non-Agent subjects (e.g., *receive* where the subject is a goal (2.17c), *open* whose subject is an instrument (2.17d)). While some highly STATIVE or abstract verbs do not allow passivization (e.g., measure phrases like *weigh* in (2.16b), idiom chunks like *kick the bucket* in (2.16c)), there are some highly stative verbs that do (e.g., *justify* in (2.17e)). Spatial relation verbs sometimes do (e.g., *surround* in (2.17f)) and sometimes don’t (e.g., *contain* in (2.16g)) passivize. And lastly, verbs that define possessional relations sometimes do (e.g., *own* in (2.17g)) and sometimes don’t (e.g., *have* in (2.16a)) passivize.

- (2.17)
- a. The threat of war was feared by everyone.
 - b. Everyone was frightened by the threat of war.
 - c. The letter was received by Marianne.
 - d. The door was opened by a brass key.

- e. Drastic measures were justified by the dire situation.
- f. The building was surrounded by police.
- g. The car was owned by Connell.

Ultimately, [Pinker \(1989: 136\)](#) suggests that a “broad-range rule” for passivization can apply productively to all and only transitive verbs that have Agents and Patients rather than a purely syntactic rule that applies to any verb with an internal (syntactic) object. For passivizable verbs that do not have Agents and Patients, Pinker follows [Bolinger \(1977\)](#) and [Anderson \(1977\)](#), who suggest that passivization seems to apply when the syntactic object either is “a Patient or is capable of being construed as one”. This line of thinking is similar to the idea of semantic coercion proposed by [Grillo \(2008\)](#) and [Gehrke and Grillo \(2009\)](#) described in the previous section and supports the idea that the ability of a verb to allow passivization is related to fine-grained distinctions based on the lexical mean of the verb.

There are cross-linguistic restrictions on which verbs can have an internal object that can be “construed as a Patient”. Of interest to us are the restrictions on non-ACTIONAL verbs that take an Experiencer role as either an internal or external argument. For example, [Grimshaw \(1990\)](#) argues that non-ACTIONAL verbs can be separated into AGENTIVE and non-AGENTIVE psych verbs, and that those non-AGENTIVE psych verbs in English that are equivalent to the Italian *preoccupare* verbs form what is referred to as “adjectival” passives rather than verbal passives (i.e., *frighten*-type verbs, [Belletti and Rizzi 1988](#)).

Adjectival passives, like in (2.18), are similar to verbal passives in that they are marked with a passive auxiliary verb (i.e., *be*) and participial inflection on the main verb. The main verb in adjectival passives ascribes adjectival properties on the subject rather than describes a verbal event. Unlike verbal passives, the argument bearing the Patient or Theme theta role in adjectival passives is not moved into the subject position but is base-generated there ([Williams, 1980](#)).¹² In English, short passives (i.e., passives without *by-*

¹²According to [Levin \(1993\)](#), there is some debate about whether a notion of “adjectival passive” that

phrases) are ambiguous between an adjectival and verbal passive (see [Wasow, 1977](#); [Levin and Rappaport, 1986](#)). So (2.18) can either have a STATIVE adjectival reading where the door is described as having the property of being closed or an EVENTIVE reading where there is a force that has caused the door to become closed. According to [Borer and Wexler \(1987, 1992\)](#), adjectival passives resist the presence of a *by*-phrase and cannot have an EVENTIVE reading. Thus, the addition of a *by*-phrase to (2.18) can only have an EVENTIVE reading where an animate or inanimate force (Marianne or the strong winds, respectively) closed the door (2.19).

(2.18) The door was closed.

- a. Adjectival passive → STATIVE reading: The state of the door is that it is closed.
- b. Verbal passive → EVENTIVE reading: There is an event in which a force closes the door.

(2.19) The door was closed by Marianne/the strong winds.

[Grimshaw](#) argues that when these *frighten*-verbs are AGENTIVE, however, then they can form verbal passives.¹³ [Landau \(2002\)](#) discusses languages in which the passivization of non-ACTIONAL psych verbs is also restricted. For example, in Hebrew, more than half of the psych verbs that assign an Experiencer theta role to its object (i.e., OBJECT-EXPERIENCER verbs) do not allow passivization, although some OBJECT-EXPERIENCER verbs may form a verbal passive, incurring an AGENTIVE interpretation ([Landau, 2002](#)). Furthermore, OBJECT-EXPERIENCER verbs can only form adjectival passives, not verbal passives, in languages like French and Italian. Nonetheless, for our present purposes, most OBJECT-

is distinct from “verbal passive” should be recognized. [Alexiadou et al. \(2015\)](#) have recently claimed that adjectival passives are not a unique class and some of them more closely resemble verbal passives. Here, I am assuming that they are distinct from each other since I am focused on long verbal *be*-passives where a *by*-phrase is present and adjectival passives do not allow *by*-phrases.

¹³See [Pesetsky \(1995\)](#) who argued that *frighten*-type psych verbs can also form verbal passives when there is an implicit causer.

EXPERIENCER and SUBJECT-EXPERIENCERS verbs (i.e., verbs that take an Experiencer as its subject) participate in the active/passive alternation in English.

(2.20) Marianne was frightened by the spiders on the wall.

(2.21) Marianne was loved by her college friends.

But while it may seem that the English passive operates on a large range of verbs (i.e., most transitive verbs), cross-linguistically, it is not the case that the verbs that do not allow passivization in English are also not allowed to passivize in other languages. For example, while [Pinker et al. \(1987\)](#) note that English does not allow highly STATIVE or abstract verbs like possessive *have* (2.16a), *weigh* (2.16b), and *cost* (2.16d) to passivize, these verbs are acceptable in the passive voice in Kinyarwanda ([Kimenyi 1980](#): 127-8):

(2.22) Ibifuungo bibiri bi-fit-w-e n'ishaati.
buttons two they-have-PASS-FV by-shirt
'Two buttons are had by the shirt.'

(2.23) Ibiro bine bi-pim-w-a n'iiki gitabo.
kilos four they-weigh-PASS-FV by-this book
'Four kilos are weighed by this book.'

Furthermore, while English does not allow intransitive verbs to passivize, [Keenan and Dryer \(1981\)](#) note that Latin allows passives of unergative verbs like *run* and German allows passives of unergatives in an impersonal construction such as *dance* in (2.24).

(2.24) Gestern wurde getanzt.
yesterday became danced
'Yesterday there was dancing.'

The seemingly large set of verbs that allow passivization cross-linguistically may be due

to some one-way implicational relationships that have been suggested by Keenan and Dryer (1981: 331): (i) if a language has passives of STATIVE verbs (e.g., *lack*, *have*, etc.) then it has passives of verbs denoting events; (ii) if a language has passives of intransitive verbs, then it has passives of transitive verbs. So, it can be argued that, perhaps, there are more verbs that allow passivization in a language like German than in English because German would allow both transitive and intransitive verbs to passivize (according to (ii) in Keenan and Dryer's (1981) implicational rules) while English only allows passives of transitive verbs.

What is clear so far is that a child learning English not only would need to have knowledge of the complex mechanics of the syntax of the verbal passive (e.g., (semantic) smuggling) but also which verbs allow passivization. We have seen so far that the set of passivizable verbs is subject to cross-linguistic variation but even within the same language, the boundaries for which verbs do and do not passivization are not readily apparent. It is an empirical question, especially for this dissertation, how English-speaking children come to have this knowledge. In the next section, I will summarize how the acquisition of passives in English has been investigated so far, including a discussion on how researchers have interpreted children's grammatical knowledge of passives based on the interaction between children's linguistic behavior and the lexical meaning of the verbs they are being tested on in the passive.

2.3 Passive Constructions in Child Grammar

According to many studies in the literature, English-speaking children do not seem to understand long passives containing an ACTIONAL verb such as (2.25) until about age 4 or 5 (Bever, 1970; Horgan, 1978; de Villiers and de Villiers, 1973). Furthermore, it has been claimed that children do not begin to understand long passives containing a non-ACTIONAL verb such as (2.26) until age 7 (Gordon and Chafetz, 1990; Maratsos et al., 1985; Hirsch and Wexler, 2006, a.o.).

(2.25) The dog was hugged by Ernie.

(2.26) The dog was liked by Ernie.

These studies have led researchers to develop various accounts of how and when children acquire the verbal passive. I will first provide a brief overview of the research that has been done thus far on children's production and comprehension of various types of passives with a particular focus on the English passive.¹⁴ I will then discuss several major theoretical proposals that have tried to account for children's delayed acquisition. I will end this section by introducing how different lexical semantic features have been proposed to best characterize the passive lexical asymmetry observed in English-speaking children.

2.3.1 Passive Usage in Children

As previously noted, external arguments in English verbal passives may optionally appear in a prepositional *by*-phrase. Passives containing the *by*-phrase are often referred to "long" passives while "short" passives are those without the *by*-phrase. English-speaking children begin to produce passives in their spontaneous speech at around three years of age but typically do not produce long passive sentences until four or five years of age; before this, children will often produce short passives (Budwig, 1990, 2001). These short passives tend to be short *get*-passives instead of *be*-passives (Harris and Flora, 1982). Children have also been observed to occasionally produce passives with verbs that do not passivize in adult English such as "He get died" or "It was bandaided", indicating some productivity with the construction (Bowerman 1982, 1988; Clark 1982; see Pinker et al. 1987 for a list of examples). Despite the ability to produce passives at a relatively early age, passives are rare in young children's speech compared to older peers (Menyuk, 1963).

¹⁴While the focus in this chapter is on children's behavioral performance and what has been proposed regarding children's grammatical representation of the passive, the quality and quantity of passives that children are exposed to in their learning environment is of equal importance to this dissertation and thus will be discussed in more detail in Chapter 3 as well as Chapter 5.

Given the rarity of passives in young children's spontaneous speech and that these passives are mostly of one type (i.e., *get*-passives), several studies have investigated how well children are able to produce passives of different kinds with certain contexts. These studies often utilize Elicited Production techniques to investigate children's production of passives. For example, [Beilin \(1975\)](#) found that, before seven years of age, very few of the children in his study produced passive descriptions of actions enacted with dolls. In particular, [Beilin](#) found that 85% of seven-year-old children produced passives when prompted with the grammatical object, compared to just 21% of four-year-old children. [Horgan \(1978\)](#) asked children ages 2 to 11 to describe pictures depicting various events (e.g., a boy standing next to a broken lamp; a broken lamp by itself). She found that the youngest children produced very few long passives but frequently produced short passives. Furthermore, when children produced long passives, these tended to either be "reversible" passives (i.e., where the subject and object can be switched and still form a plausible utterance such as *Matthew was loved by Diana*) or "non-reversible" passives (i.e., switching the arguments would result in an implausible passive such as **Matthew was broken by the lamp*). [Horgan](#) observed that the same children did not produce both reversible and non-reversible passives until age 11 whereas before, children would produce either reversible or non-reversible passives regardless of the situation. And lastly, [Crain et al. \(2009\)](#) tested 35 children in a study where an experimenter asked these children to pose questions to another experimenter. The experimenters were able to control the pragmatic context such that the use of a long passive in the posed question would constitute a felicitous response. Almost every child, as young as 3;04 years, produced a long passive in this task. [Crain et al.](#) concluded, even though most of the produced passives were *get*-passives that sometimes were also not completely grammatically well-formed (e.g., using prepositions other than *by*, or the incorrect passive participle on verbs like *ride-en*, *crash-en*), that young English-speaking children are able to produce long verbal passives when the context is pragmatically appropriate for the passive construction. Though the rarity

of passives in children’s spontaneous speech may not be particularly surprising given that passives are also rare in the linguistic input, young children’s demonstrated ability to produce them in these Elicited Production tasks suggests that investigations of children’s spontaneous speech tend to underestimate their language abilities.¹⁵

2.3.2 Investigations of Child English Passives

2.3.2.1 Long vs Short Passives

While [Horgan \(1978\)](#) noted that there is a behavioral difference between long and short passives in English-speaking children in her experiment, this difference has not been well-replicated in the literature ([Guasti, 2002, 2017](#); [Becker and Deen, 2020](#)). While there have been studies that found slightly better performance on short passives as compared to long passives, these studies do not report a statistical difference between the two variants ([Gordon and Chafetz, 1990](#); [Hirsch and Wexler, 2006](#); [O’Brien et al., 2006](#)).¹⁶ For example, [Hirsch and Wexler \(2006\)](#) found equal performance with short non-ACTIONAL passives and long non-ACTIONAL passives in 54 out of the 60 children that they tested. In addition to the mixed consensus in the literature regarding earlier acquisition of short passives as compared to long passives, we will see in [Section 2.3.3](#) that the ambiguous status of short passives between verbal and adjectival passives makes it hard to determine children’s linguistic knowledge of the verbal passive on the basis of their performance on short passives.

2.3.2.2 ACTIONAL vs Non-ACTIONAL Passives

Perhaps the starting position for most current studies of English-speaking children’s acquisition of the verbal passive, [Maratsos et al. \(1985\)](#) tested children ages 4 to 11 on their

¹⁵See [Chapter 3](#) for more discussion on the frequency of passives in the linguistic input.

¹⁶One notable exception comes from [Fox and Grodzinsky \(1998\)](#) who found eight out of thirteen English-speaking children performing significantly better on short non-ACTIONAL passives than long non-ACTIONAL passives, but see [Orfitelli \(2012: 9-10\)](#) for discussion of why these results should be considered questionable.

comprehension of long verbal passives using a variety of methodologies and found that before four to five years of age, English-speaking children consistently performed better on ACTIONAL passives (i.e., passives with verbs that denote an (observable) action like *hug*) than non-ACTIONAL passives (i.e., passives with verbs that are not observable events like *love*).¹⁷ Maratsos et al. observed the persistence of this difficulty with non-ACTIONAL passives in children until age 9. Similar results were also found by Sudhalter and Braine (1985) with three- to six-year-old children in an act-out task where children performed significantly better on ACTIONAL passives than on non-ACTIONAL passives. This lexical asymmetry for the passive voice has been replicated in several studies (Gordon and Chafetz, 1990; Fox and Grodzinsky, 1998; Hirsch and Wexler, 2006) and is sometimes referred to as the “Maratsos Effect” (Gordon and Chafetz, 1990; Hirsch and Hartman, 2006; Liter et al., 2015; Liter and Lidz, 2020). Most proposals on children’s acquisition of the English verbal passive have been focused on explaining this Maratsos Effect (see Section 2.3.3 for further discussion).

2.3.2.3 *Get*-passives

In addition to the auxiliary verb *be*, passives can also be formed with the auxiliary verb *get* as in “Marianne got hugged by Connell’s mother” (which we will call “*get*-passives”). But although much of the literature has found delayed comprehension in English-speaking children for the verbal *be*-passive, these same difficulties are not observed in children’s *get*-passives. What is important to note here is that *get*-passives are only compatible with ACTIONAL verbs and thus investigations of children’s behavior on *get*-passives do not include passives of non-ACTIONAL verbs. When looking at *get*-passives of ACTIONAL verbs, studies have found that young children exhibit no difficulty producing and understand-

¹⁷It is worth noting that five-year-old children were significantly above chance in their performance on non-ACTIONAL passives but that success on both ACTIONAL and non-ACTIONAL passives were not comparable until age 9 (Maratsos et al., 1985). As I will discuss in Section 2.4, significantly above chance performance will serve as the benchmark for determining the “Age of Acquisition” for when children acquire a verb in the passive.

ing *get*-passives (Harris and Flora, 1982; Marchman et al., 1991; Fox and Grodzinsky, 1998; Crain et al., 2009). Particularly with elicited production tasks, studies found that young children produced higher rates of *get*-passives compared to *be*-passives and compared to adult production (Turner and Rommetveit, 1967; Marchman et al., 1991; Crain et al., 2009). In comprehension tasks, Harris and Flora (1982) compared children's performance on *get*-passives and *be*-passives of different ACTIONAL verbs and found that children ages 4 to 9 were performing significantly better on *get*-passives than on *be*-passives, suggesting that *get*-passives are overall easier for children.

More recently, however, Gotowski (2019) attempted to systematically compare the acquisition of *get*- and *be*-passives. She conducted a picture-matching task and an act-out task with English-speaking children ages 3 to 6 and found that three-year-old children were only successful on *get*-passives when the arguments were animate. Furthermore, children ages 4 to 6 performed equally well with both *get*- and *be*-passives. From these results, Gotowski concluded that there is no advantage for either type of passive despite young children seemingly preferring to produce *get*-passives more frequently. As the focus of this dissertation is on verbal *be*-passives, I will set aside children's acquisition of *get*-passives for now and return to them in Chapter 7 when I discuss possible learning paths for children.

2.3.3 Previous Proposals

Several theoretical accounts have been proposed as explanations for why children are delayed in their acquisition of the verbal passive compared to other syntactic constructions of object movement (e.g., object *wh*-questions, object relatives). This section provides brief descriptions of some of the major proposals.

A-Chain Deficit Hypothesis. Borer and Wexler (1987, 1992) proposed that young children lack the ability to perform the movement operation required to raise the internal ar-

gument to the subject position in passive sentences. As previously noted in Section 2.2.1, the raising of the verb's internal argument to the (syntactic) subject position forms an argument chain (A-chain) between the subject position and the trace that is left behind in the base-generated position (as the sister of the verb). Borer and Wexler argued that the mechanism of forming A-chains is unavailable for children up to age 6. Before then, they suggest that young children circumvent this limitation by forming adjectival passives whenever they are presented with verbal passives of ACTIONAL verbs.^{18,19} As noted before, this is possible because short passives (i.e., passives without *by*-phrases) in English are ambiguous between an adjectival and a verbal passive (Wasow, 1977). According to Borer and Wexler, adjectival passives resist the presence of a *by*-phrase and cannot have an EVENTIVE reading. Thus, the addition of a *by*-phrase to a short passive will unambiguously have a verbal passive interpretation.

Adjectival passives are argued to be easier for children because movement of the direct object is not required for this construction; the subject of an adjectival passive is base-generated in that position (Williams, 1980).²⁰ For non-ACTIONAL passives, Borer and Wexler claimed that adjectival passives cannot be formed from non-ACTIONAL verbs. So when encountering passives of non-ACTIONALS, children cannot easily form adjectival passives as they would with ACTIONAL verbs. This is what leads to the children's failure on non-ACTIONAL passives often observed in the literature. Hence, children would not be able to successfully interpret verbal passives containing non-ACTIONAL passives until they acquire the ability to form A-chain dependencies needed for the proper formation of

¹⁸Horgan (1978) also made a similar argument and argued that children initially treat passives as STATIVE (or adjectival) structures and are therefore not compatible with an AGENTIVE *by*-phrase.

¹⁹There are some instances where adjectival passives can appear with *by*-phrases as shown in (i) from Bruening (2014). However, the presence of *by*-phrases does at least disambiguate verbal from adjectival passives in the experimental studies often conducted with young children. Thus, this dissertation will only focus on children's successes and failures with long (verbal) passives.

(i) ... for 300 years these gardens were unseen, except by the favored few.

²⁰Because short passives are ambiguous between an adjectival and verbal passive and adjectival passives are argued to be easier for children due to the lack of A-chains in the structure, the account proposed by Borer and Wexler (1987, 1992) makes the prediction that short passives should be easier for young children than long passives. See Section 2.3.2.1 for discussion on the empirical data from children regarding these predictions.

verbal passives. This ability is argued to be innate in children but emerges maturationally around age 6.

The A-Chain Deficiency Hypothesis has fallen out of favor since it makes the prediction that young children should have difficulty with all syntactic constructions that involve the formation of A-chains. But children have been observed to have adult-like knowledge of object *wh*-questions, object relative clauses, and unaccusatives much earlier than verbal passives, suggesting that children have the ability to form A-chains much earlier as well. One lasting contribution of [Borer and Wexler; Borer and Wexler's \(1987; 1992\)](#) proposal is that children are adult-like in their structural representation of the verbal passive when they have mastered long non-ACTIONAL passives and that children's early success on ACTIONAL passives should be attributed to non-adult-like strategies such as interpreting ACTIONAL passives as adjectival passives. What will become clearer later on in the dissertation is that not all non-ACTIONAL passives are difficult for young children and that the non-ACTIONAL passives that are difficult for children are difficult for adults as well, suggesting that the difficulty observed in children may not be due to an immature structural representation of the verbal passive. If this indeed holds true, then theoretical proposals that attribute difficulty of long non-ACTIONAL passives to non-adult-like structural representation of the verbal passive in young children would need to be modified.

Theta-Transmission. [Fox and Grodzinsky \(1998\)](#) suggested that young children do not have access to all grammatical aspects of the verbal passive due to processing constraints. According to their account, young children do not have the processing capacity to transmit the external theta role of the verb to the *by*-phrase in long non-ACTIONAL passives. This is because the theta role that is transmitted in non-ACTIONAL passives is an Experiencer role rather than the typical Agent role. In the case of ACTIONAL passives, [Fox and Grodzinsky](#) argued that theta-transmission is unnecessary because the preposition *by* that is used with canonical Agent roles is non-passive (and only homophonous with

the passive preposition *by*) and thus the Agent role can be transmitted to the external argument in the preposition phrase directly and would not overload the child’s processing capacity. In their study, [Fox and Grodzinsky](#) found 8 out of 13 children to have good performance with short and long ACTIONAL passives as well as short non-ACTIONAL passives; with long non-ACTIONAL passives, their performance was at chance. They argued that this ability to transmit the Experiencer role to the *by*-phrase in a long non-ACTIONAL passive is subject to maturation in young children but that children have access to all other grammatical components needed to form a verbal passive in English.

Semantic Smuggling. [Snyder and Hyams \(2015\)](#) have proposed that children have difficulty with passivizing non-ACTIONAL verbs because they cannot yet perform a step of “semantic coercion” that is required for passivization. Following [Grillo \(2008\)](#) and [Gehrke and Grillo \(2009\)](#) (described in the Section 2.2.1), non-ACTIONAL verbs do not have the syntax that is compatible with passivization because they lack what [Gehrke and Grillo](#) called “change-of-state” semantics. Where adults sometimes allow non-ACTIONAL verbs to passivize, [Gehrke and Grillo \(2009\)](#) suggested that a form of “semantic coercion” has applies to the non-ACTIONAL verb, thereby introducing a BECOME operator which converts a simple state into a change of state. For [Snyder and Hyams \(2015\)](#), passives with ACTIONAL verbs are easier for young children because ACTIONAL verbs do not require this step of semantic coercion whereas children’s success on passives with non-ACTIONAL verbs is delayed until they can perform this step.²¹

The proposals described above posit an aspect of the syntax that is needed for adult-like performance on the verbal passive that is inaccessible to young children either for structural or processing reasons. For [Borer and Wexler \(1987\)](#), the ability to form A-chains is innate and present at birth but is subject to maturation. In other words, the ability

²¹This knowledge of semantic coercion is assumed to be maturational, but details are left open as to whether young children truly lack some grammatical knowledge until later in their life or whether their processing capacity prevents them from deploying the knowledge. (For discussion favoring a processing-based account, see [Borga and Snyder, 2018a,b](#)).

to deploy this mechanism is tied to certain developmental milestones and comes online for children around age 5 to 6. On the other hand, [Fox and Grodzinsky \(1998\)](#) reject the idea that the locus of maturational change is the grammar itself and proposed that the processes needed to form the passive such as the transmission of the theta role to the *by*-phrase and the formation of an A-chain overloads the child's processing capacity. Thus, over time, as a child's processing capacity matures, so should their ability to transmit the theta role to the *by*-phrase, resulting in success on the long passive. Lastly, [Snyder and Hyams \(2015\)](#) proposed that what matures in children is their ability to semantically coerce non-ACTIONAL verbs to have change-of-states and only then will they be able to perform the semantic smuggling necessary to form a verbal passive. This processing difficulty is expected to improve with age.

Incremental Processing Hypothesis. Rather than appealing to an immature or inaccessible grammatical representation of the passive, [Huang et al. \(2013\)](#) have proposed that children's poor behavioral performance on passives could be better explained by a processing account whereby young children have difficulty revising their initial parsing of the subject of a passive as the Agent of the event, which they have named the "Incremental Processing Hypothesis" (for a similar proposal, see [Hyams et al. \(2006\)](#)). [Huang et al.](#) argued that canonical word order (e.g., Subject-Verb-Object in English) is acquired very early, and therefore children are used to mapping the Agent theta role onto the subject/first noun phrase and the Theme theta role onto the object/second noun phrase in active sentences. Because passives reverse this thematic role mapping, children may initially, and incorrectly, map the Agent theta role onto the first noun phrase during online processing. It is only when they hear the verbal morphology that children realize they are processing a passive sentence. Starting with [Trueswell et al. \(1999\)](#), it has been observed that young children often have difficulty reanalyzing incorrect initial sentences parsings, the so-called "Kindergarten Path Effect". Using an eye-tracking and act-out paradigm,

Huang et al. tested Mandarin-speaking five-year-old children on passive sentences and found that children assign theta roles incrementally with the first noun phrase initially receiving the Agent theta role.²²

The predictions of the Incremental Processing Hypothesis were further tested by Deen et al. (2018) who hypothesized that if children's difficulty with passives is with their expectations regarding thematic roles and their inability to reanalyze in real time, then repeating the test sentence would allow children to correct their parsing mistake. In a Truth Value Judgment Task with four- and five-year-old children, Deen et al. found that when the test sentence is repeated, young children's accuracy on long non-ACTIONAL passive sentences rose to a rate of 83.3%, compared to 55% in the baseline condition (i.e., only one instance of the test sentence). This suggests that a repetition of the test sentence improves comprehension of passives as it allows young children time to reanalyze their initial incorrect parse as predicted by the Incremental Processing Hypothesis.

Pragmatically Motivating the Passive. Crain and Fodor (1989) noted that long passives are generally rare in the speech of adults and children, and that this may be because long passives are pragmatically marked forms that are appropriate only in certain discourse situations. O'Brien, Grolla, and Lillo-Martin (2006) proposed that children's poor performance on long ACTIONAL and non-ACTIONAL passives in previous studies may have resulted from the use of pragmatically infelicitous contexts in experimental stimuli. For O'Brien et al., a story was deemed to be pragmatically appropriate for the use of a *by*-phrase passive if, in addition to the character corresponding to the actual Agent or Experiencer, there was another character who could have been the Agent or Experiencer. This contrast between the actual Agent or Experiencer and the potential Agent or Experiencer would motivate the use of a *by*-phrase.

²²While the Incremental Processing Hypothesis is an account of sentence processing by children more broadly, it is often discussed in the context of the passive for its prediction of children's behavior in the face of the systematic demotion of the Agent from the subject position (Huang et al., 2013; Ehrenhofer, 2018; Deen et al., 2018).

When three- and four-year-old children were presented with stories that contained two potential Agents/Experiencers in a Truth Value Judgment Task (Crain and McKee, 1985; Crain and Thornton, 1998, 2000), O'Brien et al. found that children were significantly above chance for both long ACTIONAL and non-ACTIONAL passives, despite previously reported poor performance on long non-ACTIONAL passives (Maratsos et al., 1985).²³ Additionally, when the three-year-old children were presented with stories that contained only one potential Agent/Experiencer, they performed at chance on long ACTIONAL and long non-ACTIONAL passives. These results were interpreted as evidence of children's difficulty on long non-ACTIONAL passives being the result of pragmatically infelicitous experimental materials rather than delayed knowledge of the verbal passive (cf. replication attempts by Nguyen 2015; Nguyen and Snyder 2017; Deen et al. 2018 all with results different from those of O'Brien et al. 2006).

More recently, Liter and Lidz (2020) have proposed that the lexical asymmetry observed in Maratsos et al. (1985) is a pragmatic artifact along similar lines to O'Brien et al. (2006) and that (at the very least) four-year-old children already have the syntax of the English verbal passive. They argued that children's difficulty with some long non-ACTIONAL passives is driven by a perceived conflict between the information structure of the passive and a preference for assertions to be about the topic of a sentence, which is most often the subject. In the case of the passive, the subject of the sentence is the internal argument while the external argument is located in the *by*-phrase. Specifically, Liter and Lidz observed that a *by*-phrase containing a quantificational noun phrase, as in (2.28), sounds less pragmatically weird than a *by*-phrase containing a referential noun phrase, as in (2.27) in out-of-the-blue contexts. This is because (2.27) is concerned with Connell's mental state (as the default meaning of being the Experiencer of the non-ACTIONAL verb *love*) but the derived subject, and thereby the preferred topic of the sentence, is *Marianne*. Liter and Lidz proposed that the inclusion of a quantificational noun phrase in the *by*-phrase shifts

²³For verbs tested in O'Brien et al. (2006), see Table 2.5 further below.

the topic of the passive back to the subject such that (2.28) is now an assertion about Marianne (i.e., she’s popular). This alignment of the topic and the derived subject makes the passive of a non-ACTIONAL verb more felicitous in out-of-the-blue contexts.²⁴

(2.27) ?Marianne was loved by Connell. (referential noun phrase)

(2.28) Marianne was loved by everybody. (quantificational noun phrase)

When four-year-old children were presented with stories that more clearly highlighted the topic, i.e., the subject of the passive, in a Truth Value Judgment Task, [Liter and Lidz](#) found that children were significantly above chance for all eight non-ACTIONAL verbs that were tested in the passive.^{25,26} In other words, when the experimental stimuli ensured appropriate pragmatic licensing, four-year-old English-speaking children did not show any difficulty with comprehending non-ACTIONAL passives regardless of whether there was a referential or quantificational noun phrase in the *by*-phrase.

The proposals above have tried to explain whether and why English-speaking children might be delayed in their comprehension of the verbal passive, often using the lexical asymmetry as the threshold for when children are adult-like in their behavior on long verbal passives. But while many of the above proposals remain attractive among researchers of children’s acquisition of passives, there exists a body of literature that directly manipulates lexical verb meanings in an effort to characterize the interaction between verb type and children’s performance on verbal passives. As we will see in the next section, several different lexical semantic features have been proposed to better characterize children’s lexical verb asymmetry in the verbal passive, going beyond

²⁴[Liter and Lidz \(2020\)](#) noted that this discourse manipulation is not restricted to quantifiers, as adverbial modification can also manipulate the default information structural properties of a non-ACTIONAL passive to make it more felicitous, as in (ii).

(i) ?Connell was seen by Marianne.

(ii) Connell was frequently seen by Marianne.

²⁵While it is not clear under what exact conditions [Liter and Lidz \(2020\)](#) consider a context to be “pragmatically licensed” for the passive, a sample story from their experiment makes use of multiple characters including potential and actual Experiencers along the same lines as [O’Brien et al. \(2006\)](#)

²⁶The eight non-ACTIONAL verbs of interest were *know, love, like, miss, spot, see, forget, and hear*.

the “ACTIONAL”/“non-ACTIONAL” asymmetry first proposed by Maratsos et al. (1985). Because most of the above proposals on children’s acquisition assume an interaction between children’s behavior on passives and verb type, it is important to have an accurate understanding of how this interaction manifests.

2.3.4 Lexical semantic features

Several experimental studies (Maratsos et al., 1985; Pinker et al., 1987; Messenger et al., 2012; Liter et al., 2015; Nguyen, 2015) have collectively described seven potentially relevant lexical semantic features that can affect children’s performance on the verbal passive: ACTIONAL, STATIVE, VOLITIONAL, AFFECTED, and the thematic-role relations OBJECT-EXPERIENCER (OBJ-EXP), SUBJECT-EXPERIENCER (SUBJ-EXP), and AGENT-PATIENT (AGT-PAT). For these researchers, use of the lexical semantic features that they proposed ranged from descriptive observations of the children’s behavior in their experiments to direct manipulations that affected children’s performance.

In the following sections, I will provide background summaries of these studies along with definitions of the proposed lexical semantic features. But while these researchers may have different explanations for why their features matter for children’s acquisition (along the same lines as those described in the previous section), what is of interest to us and will serve as the foundational background for the remainder of the dissertation is the lexical semantic features themselves and their proposed “signal” or definitions.²⁷

2.3.4.1 Maratsos, Fox, Becker, and Chalkley (1985): ACTIONALITY Distinction

Maratsos et al. (1985) hypothesized that ACTIONAL verbs, which denote an action (e.g., *hug*, *chase*, etc.), will be easier for children to understand in the passive than non-ACTIONAL verbs, which denote an experience, or a non-action (e.g., *see*, *forget*, *like*, etc.). They

²⁷As will become clearer later on in this dissertation, the experiments described in this section will help us answer Q2 from Chapter 1: What is the nature of children’s linguistic knowledge and their capacity to deploy that knowledge during the course of development?

conducted two experiments and found that children seem to acquire ACTIONAL passives earlier than non-ACTIONAL passives. In the first experiment, four- and five-year-old children were tested on four ACTIONAL and eight non-ACTIONAL verbs in a task where, when prompted with the test sentence followed by the question “who did it?”, they had to point to the toy character that did the event denoted by the verb. For example, when presented with the test sentence “Superman was seen by Batman”, children were supposed to point to Batman as the toy character that did the “seeing” event. [Maratsos et al.](#) found that children selected the correct referent in the ACTIONAL condition 67% of the time compared to only 40% of the time in the non-ACTIONAL condition. In the second experiment, children aged 4 to 11 years were tested on a picture selection task where children were given two pictures and asked to select the one that matched the test sentence.²⁸ The results are presented in Table 2.1. While children were essentially at ceiling with the active sentences in both ACTIONAL and non-ACTIONAL conditions and the passive in the ACTIONAL condition, children did not seem to reach the same level of success on the non-ACTIONAL passives until age 9 (see [Nguyen 2015](#); [Nguyen and Snyder 2017](#); [Nguyen et al. 2018](#) for replications of these results using Truth Value Judgment Tasks).

Table 2.1: Percent correct responses to a picture selection task testing active and passive sentences ([Maratsos et al. 1985](#): 180).

Age	Actional		Non-actional	
	Active	Passive	Active	Passive
4 yr	97	0.85	92	0.34
5 yr	99	0.91	96	0.65
7 yr	99	0.92	97	0.62
9 yr	100	0.96	99	0.87
11 yr	100	0.99	100	0.99

For our purposes, [Maratsos et al. \(1985\)](#) defines a verb to be ACTIONAL if it denotes an action and is not a mental, psych, or perception verb. A signal we can use to identify an ACTIONAL verb is whether the event described by the verb is observable. So, *eat* would

²⁸Non-ACTIONAL verbs were depicted using thought bubbles, or other visual mechanisms to indicate the non-ACTIONAL meaning.

be +ACTIONAL because eating can be directly observed (e.g., *The penguin is eating a fish* – we can observe the penguin eating the fish). In contrast, a psych verb like *love* would be –ACTIONAL because the internal state caused by loving cannot be directly observed (e.g., *Lisa loves penguins* – we cannot observe Lisa’s internal state of pure love because that psychological state is internal to Lisa).

2.3.4.2 **Pinker, Lebeaux, and Frost (1987): AFFECTEDNESS Distinction**

[Pinker et al. \(1987\)](#) examined whether the passives of some verbs were more productive for children than passives of other verbs. Specifically, they were interested in whether children’s performance would be impacted based on whether the novel verb’s internal argument/object was affected by the denoted event. To this end, they conducted a series of novel (i.e., nonce) verb learning studies where children were taught novel verbs either in the active or passive voice. Young children’s comprehension of these novel verbs in the passive was tested by having the children act-out different events or states according to a presented test sentence using toys. Of particular interest to us is their second experiment where three- to five-year-old children were tested on novel action verbs roughly corresponding to “back into” or “slide down the back of” and novel spatial verbs corresponding to “to contain” or “to suspend from”. Here, the object of the novel action verbs would be affected while the object of the novel spatial verbs would be unaffected by the events or states denoted by the novel verbs. The results are shown in [Table 2.2](#). Along with results from their other novel-verb learning studies, [Pinker et al.](#) took children’s performance as evidence that English-speaking children passivize verbs that have an affected object more productively than those with an unaffected object.

For our purposes, the AFFECTED feature applies to verbs where the subject affects the object. For example, in “Matthew annoyed Diana”, Diana is affected by Matthew – she is experiencing a state of annoyance because of him (*annoy* = +AFFECTED). This contrasts with “Matthew liked Diana”, where Diana isn’t impacted by Matthew liking her, even

Table 2.2: Percentage of correctly acted out items in comprehension task (Pinker et al. 1987: 223).

Age	Taught in active voice		Taught in passive voice	
	Act out active	Act out passive	Act out active	Act out passive
	Action verbs			
3-4.5	75	56	81	63
4.5-5.5	100	88	94	81
Mean correct:	88	72	88	72
	Spatial verbs			
3-4.5	44	62	56	50
4.5-5.5	81	88	100	50
Mean correct:	62	76	78	50

though Matthew is impacted himself (*like* = -AFFECTED).

2.3.4.3 Liter, Huelskamp, Weerakoon, and Munn (2015): Distinction Based on STATIVITY and VOLITIONALITY

Liter et al. (2015) questioned whether the “non-ACTIONAL” verbs used in Maratsos et al. (1985) should be considered a linguistically homogenous class. They argued that the verbs often used in experimental studies of children’s acquisition of passives can be split into three verb classes based on verbal diagnostics for EVENTIVITY and AGENTIVITY: ACTIONAL verbs are EVENTIVE AGENTIVE verbs, and non-ACTIONAL verbs are split into EVENTIVE non-AGENTIVE verbs and non-EVENTIVE non-AGENTIVE (i.e., STATIVE) verbs. For example, the verbs *watch*, *see*, and *like* behave differently based on tests for EVENTIVITY and AGENTIVITY as seen in examples (2.29)-(2.31) and thus should be differentiated accordingly when testing children’s comprehension of passives of different verbs.

- (2.29) EVENTIVE AGENTIVE: *watch*
- a. *Grover watches Elmo.
 - b. Grover deliberately watched Elmo.

- (2.30) EVENTIVE non-AGENTIVE: *saw*

- a. *Grover sees Elmo.
- b. *Grover deliberately saw Elmo.

(2.31) Non-EVENTIVE non-AGENTIVE (STATIVE): *like*

- a. Grover likes Elmo.
- b. *Grover deliberately liked Elmo.

In two Truth Value Judgment Tasks, [Liter et al.](#) tested whether children’s performance on verbal passives was impacted by the AGENTIVITY or EVENTIVITY of the verb. In experiment 1, they compared four- and five-year-old children’s comprehension of passives of EVENTIVE AGENTIVE verbs (e.g., *watch*) to passives of EVENTIVE non-AGENTIVE verbs (e.g., *see*). Children were found to perform significantly better on EVENTIVE AGENTIVE verbs than EVENTIVE non-AGENTIVE verbs. In experiment 2, children’s comprehension of passives of EVENTIVE non-AGENTIVE verbs (e.g., *see*) was compared to passives of non-EVENTIVE non-AGENTIVE verbs (e.g., *like*) and the researchers found an effect of EVENTIVITY such that children performed significantly better on EVENTIVE non-AGENTIVE verbs than non-EVENTIVE non-AGENTIVE verbs. [Liter et al.](#) suggested that children learn the passives of different verbs in the order of EVENTIVE AGENTIVE > EVENTIVE non-AGENTIVE > non-EVENTIVE non-AGENTIVE, and that the lexical asymmetry observed in the studies by [Maratsos et al. \(1985\)](#) was likely due to children’s incremental learning of the range of passivizable verb types.

For the purposes of the current investigation, I will use the converse to the lexical semantic feature EVENTIVE, namely STATIVE. Furthermore, I will rename AGENTIVE as VOLITIONAL in order to avoid terminological overlap with the AGENT-PATIENT feature (in the next section) proposed by [Messenger et al. \(2012\)](#). [Liter et al. \(2015\)](#) defined verbs to be +STATIVE when they are acceptable in the simple present tense in an “out of the blue” context.²⁹ For example, “Diana loves Matthew” sounds acceptable without any special

²⁹STATIVITY can also be defined as a verb being unacceptable in the simple progressive form – for in-

context (*love* = +STATIVE). This contrasts with “Diana carries Matthew”, which sounds odd out of the blue unless we are narrating an event in real time (*carry* = –STATIVE).³⁰ Secondly, [Liter et al. \(2015\)](#) defined a verb to be +VOLITIONAL when it is acceptable following the adverb *deliberately*. For example, “Matthew deliberately annoyed Diana” sounds acceptable, and describes an event where Matthew made a concerted effort to annoy Diana (*annoy* = +VOLITIONAL). In contrast, “Matthew deliberately saw Diana” sounds somewhat odd in its default interpretation, as it describes an event where Matthew has preternatural control over his visual perception and can choose whether or not to consciously perceive Diana (*see* = –VOLITIONAL).

2.3.4.4 [Messenger, Branigan, McLean, and Sorace \(2012\)](#): Distinction Based on Thematic Roles

[Messenger et al. \(2012\)](#) observed that while the ACTIONAL verbs used in the studies by [Maratsos et al. \(1985\)](#) were verbs that encode an action and canonically assign an Agent role to the verb’s subject and a Patient role to the verb’s object in an active sentence (i.e., AGENT-PATIENT verbs such as *hug*), all of the non-ACTIONAL verbs that were tested on children in that study were exclusively verbs that canonically assign an Experiencer role to the verb’s subject and a Theme role to its object in an active sentence (i.e., Experiencer-Theme verbs such as *like*). [Messenger et al.](#) investigated how children would perform on passives of verbs that canonically assign an Experiencer role to the verb’s object and a Theme role to its subject in an active sentence (i.e., Theme-Experiencer verbs such as *frighten*). In a picture-sentence matching task, three- and four-year-old children were asked to select between two pictures according to which one matched the test

stance, “Diana is loving Matthew” is less acceptable than “Diana is carrying Matthew” ([Vendler, 1957](#)). Here, we use the signal for STATIVITY defined in [Table 2.4](#), following the definition coming from the prior acquisition work of [Liter et al. \(2015\)](#)

³⁰In a narration of current activities, –STATIVE verbs would be acceptable in the simple present tense as in (i). Since the test for STATIVITY used by [Liter et al. \(2015\)](#) is restricted to out-of-the-blue contexts, I will not be including grammatical judgments like (i) for the lexical feature annotations.

(i) Look, Grover watches Elmo, and then wow, Grover is grossed out by Elmo’s eating habits!

sentence. The results are shown in Table 2.3. Young children were found to be sensitive to thematic-role mappings: while their performance on passives of AGENT-PATIENT and OBJECT-EXPERIENCER verbs were comparable, passives of SUBJECT-EXPERIENCER verbs elicited the poorest performance. This lexical asymmetry in children’s behavior was also observed in the adult participants performing the same task. However, in separate experiments, when participants heard the experimenter produce passives for an unrelated event (i.e., were primed for the passive) beforehand, participants exhibited no asymmetry in the type of verbs that they were willing to produce in the passive. In light of these results, Messenger et al. suggested that the lexical verb asymmetry found in previous studies may be task-related rather than evidence of delayed knowledge of the passive.

Table 2.3: Frequency of correct and incorrect match response by verb type and structure (Messenger et al. 2012: 581).

Verb Type	Structure	Match response	
		Correct	Incorrect
Agent-patient	Active	120	23
	Passive	111	32
Theme-Experiencer	Active	111	33
	Passive	99	44
Experiencer-theme	Active	90	54
	Passive	58	84

While Messenger et al. (2012) used the terms “Theme-Experiencer” and “Experiencer-Theme”, I will instead refer to these features as OBJECT-EXPERIENCER and SUBJECT-EXPERIENCER to avoid any unnecessary confusion. For the definitions of the features OBJECT-EXPERIENCER (OBJ-EXP), SUBJECT-EXPERIENCER (SUBJ-EXP), and AGENT-PATIENT (AGT-PAT), Messenger et al. focused on the thematic status of the internal argument of the verb in question (as either an Experiencer or a Patient/Theme). Specifically, when verbs are –ACTIONAL, they often involve Experiencers (of possibly mental, psychological, or perceptual states). A verb is +OBJ-EXP when the internal argument is an Experiencer (e.g., *Matthew frightens Diana* – Diana is the Experiencer of the fright). A verb is +SUBJ-EXP when the external argument is an Experiencer (e.g., *Diana likes Matthew* – Diana is the Ex-

perceiver of the liking). When verbs are +ACTIONAL and the thematic roles are Agent and Patient for the external and internal arguments respectively, the verb is +AGT-PAT. For example, *The penguin eats the fish* describes an event where the penguin is the Agent and the fish is the Patient (*eat* = + AGT-PAT). This contrasts with *whisper* (e.g., *Diana whispered the secret*), which is +ACTIONAL but does not obviously involve Agent and Patient roles; therefore, it is –AGT-PAT.³¹

2.3.4.5 Summary

Table 2.4 below summarizes the seven lexical semantic features that are of interest to this dissertation including the definitions that I will use as a signal for whether or not a verb has those features. Because I am deriving the signal of these lexical semantic features from the previous literature, they may be morphosyntactic (e.g., a context the verb can appear in) or semantic.³²

Table 2.4: Descriptive lexical semantic features derived from prior experimental studies, including signals of that feature and example verbs with (+) and without (–) that feature.

Studies	Feature	Signal	+	–
Maratsos et al. (1985) Nguyen (2015)	ACTIONAL	Observable	<i>eat</i>	<i>scare</i>
Liter et al. (2015)	STATIVE	Simple present tense in “out of the blue” context	<i>scare</i>	<i>eat</i>
Liter et al. (2015)	VOLITIONAL	“deliberately <i>VERB</i> ”	<i>annoy</i>	<i>see</i>
Pinker et al. (1987)	AFFECTED	X affects Y	<i>annoy</i>	<i>like</i>
Messenger et al. (2012)	OBJ-EXP	–ACTIONAL where object is Experiencer	<i>frighten</i>	<i>chase</i>
Messenger et al. (2012)	SUBJ-EXP	–ACTIONAL where subject is Experiencer	<i>like</i>	<i>annoy</i>
Messenger et al. (2012)	AGT-PAT	+ACTIONAL where θ -roles = Agent, Patient	<i>eat</i>	<i>whisper</i>

³¹Given these lexical feature annotations based on thematic-role relations, it would in principle be possible to have a verb that is [–AGT-PAT, –OBJ-EXP, –SUBJ-EXP]. For example, intransitive verbs like *snow* would fall under this category.

³²As such, it may be more appropriate to refer to these features as “lexical” rather than “lexical semantic” features. However, the use of the latter term helps us keep in mind that these features refer to a division amongst verbs based on the meaning or semantic characterization of the verbs.

It is important to note that, apart from recharacterizing the “ACTIONAL/non-ACTIONAL” distinction by [Maratsos et al. \(1985\)](#), these proposals tend to involve descriptive features proposed by previous experimenters to explain specific experimental results rather than theoretically-motivated features that were necessarily intended to be mutually exclusive. Thus, there has not yet been a formal account of how well these descriptive features capture the lexical asymmetry observed in children’s development of the verbal passive. Moreover, it’s not clear whether (or how much) these features overlap semantically. Here, I will treat these features as independent from each other, as there is no theoretical account yet that synthesizes them any other way. In the next section, I will describe a synthesis of experimental studies on children’s comprehension of the English verbal passive which will allow us to describe the passive lexical asymmetry in better detail as well as examine how well the proposed lexical semantic features can account for children’s behavior.

2.4 Synthesis of Experimental Studies

In order to investigate how well these lexical semantic proposals can account for English-speaking children’s comprehension of the verbal passive, we need to have a better understanding of how well children perform with which verbs and crucially at which age. To achieve this, we need a synthesis of experimental studies of different experimental studies that have been conducted with English-speaking children. My goal here is to estimate the earliest age at which we can be confident that children understand the passive of a particular verb (which I will sometimes refer to as a “lower bound” on when children have a certain piece of linguistic knowledge); thus, I am not concerned with spontaneous production studies as they tend to underestimate children’s grammatical knowledge. In this section, I will first describe the synthesis of experimental studies that I conducted of studies concerned with English-speaking children’s comprehension behavior on the verbal passive; my description will include summarizing the verbs that have previously been tested and the earliest age at which children begin to succeed on these verbs in the passive

voice. I will then show that, when viewed through the lens of lexical semantic features, the proposals described in Section 2.3.4 are unable to account for the lexical asymmetry observed in children’s behavior in these studies. I will end this section by discussing some limitations of the synthesis of experimental studies.

2.4.1 Selection of Included Studies

Twelve experimental studies were included in this synthesis of experimental studies. Selection of studies was based on the following criteria: (i) they tested English-speaking children; (ii) they are experimental studies (rather than spontaneous production studies); (iii) they tested long verbal *be*-passives; (iv) they did not include experimental manipulations that are predicted to increase children’s accuracy rates (e.g., repetition of test sentences, Deen et al. (2018)); and (v) they report the specific verbs that were tested in their study.³³

Several types of information were extracted from the synthesis of these twelve studies: (i) the verbs used as stimuli (Table 2.5), and (ii) children’s performance on verbal passives for those verbs at the different ages that were tested.^{34,35} Because I am concerned with children’s behavior on the long verbal passive for different verbs, I do not differentiate studies that used different kinds of comprehension methods (e.g., Truth Value Judgment Tasks, picture-selections, etc.) and the successes and failures of children’s performance were accepted regardless of methodology as long as the inclusion criteria for experimental studies was maintained. Furthermore, any benefit or hindrance to children’s performance brought on by the choice of methodology should have a global effect such that any

³³To the best of my knowledge, there were no other studies that could be included under these criteria. However, the loosening of any one of these criterion would allow more studies to be included (e.g., the priming experiments in Messenger et al. (2012)).

³⁴See Appendix A.1 for more details of the studies that were included in the synthesis of experimental studies.

³⁵These studies either reported successful performance on these verbs in the active voice or did not report any difficulty in comprehending the meanings of these verbs. I take this to mean that unsuccessful performance in these studies results from children’s difficulty with these verbs in the verbal passive rather than difficulty with the task or the meanings of the verbs themselves.

lexical asymmetry should still be observed.³⁶

Table 2.5: Studies, methodologies, and verbs used in the synthesis of experimental studies.

Studies	Methodology	Verbs tested
de Villiers and de Villiers (1973)	Act-Out	<i>kiss, push, hit, bite, bump, touch</i>
Maratsos and Abramovitch (1975)	Act-Out	<i>kick, kiss, push, hit, bite, bump, tickle, touch</i>
Maratsos et al. (1985)	Picture-Selection	<i>hold, kick, kiss, push, shake, wash, find, forget, hate, like, love, remember, hear, know, miss, see, smell, watch</i>
Gordon and Chafetz (1990)	Truth-Value Judgment	<i>carry, drop, eat, hold, hug, kick, kiss, shake, wash, forget, hate, like, remember, believe, hear, know, see, watch</i>
Fox and Grodzinsky (1998)	Truth-Value Judgment	<i>chase, hear, see, touch</i>
Hirsch and Wexler (2006)	Picture-Selection	<i>push, kiss, kick, hold, remember, love, hate, see</i>
O'Brien et al. (2006)	Truth-Value Judgment	<i>hug, chase, like, see</i>
Crain et al. (2009)	Elicitation	<i>eat, kiss, push, hit, bite, crash, kill, knock, lick, pick up, punch, scratch, shoot</i>
Messenger et al. (2012)	Picture-Selection	<i>carry, hit, frighten, pat, pull, scare, shock, squash, surprise, upset, hate, love, remember, annoy, bite, hear, ignore, see</i>
Orfitelli (2012)	Picture-Selection	<i>carry, kick, kiss, push, love, remember, hear, see</i>
Nguyen et al. (2018)	Truth-Value Judgment	<i>hug, chase, like, see</i>
Liter et al. (2015)	Truth-Value Judgment	<i>wash, find, fix, forget, paint, spot, hate, love, know</i>

³⁶It is a little controversial as to whether an elicitation task such as Crain et al. (2009) should be included in a synthesis of experimental studies about children's comprehension. I am including this study in the synthesis of experimental studies because the overall goal and conclusion of Crain et al. (2009) are about probing children's grammatical knowledge of the verbal passive based on the verbs that children were willing to use in the passive to denote certain events. But as we will see later, the exclusion of these verbs will minimally change the results. The inclusion of these verbs will also increase the variety of verbs that we can look for when discussing which verbs children hear in the passive in their linguistic input in Chapter 3.

2.4.2 Age of Acquisition (AoA)

From these studies, English-speaking children’s reported performance on verbal passives across multiple verbs was used to identify an “age of acquisition” (henceforth, “AoA”) for verbal passive knowledge of individual verbs. I determined a verb’s AoA by identifying the youngest age when children begin performing significantly above chance in any of the studies; thus, if multiple studies reported successful performance on a particular verb, I chose the youngest successful age group that was tested. For the studies that only reported performance on collapsed groups of verbs, an AoA was assigned for each verb that belonged in a group. For example, a study that reported success on ACTIONAL verbs that collapsed across *hug*, *chase* and *eat* will receive the same assigned AoA for each of those verbs.

The specific AoA I chose for a verb was based on the age groups that were targeted by the studies in the synthesis of experimental studies. For example, I determined the AoA for *hate*, *like*, *love*, and *remember* to be five years of age because [Maratsos et al. \(1985\)](#) targeted “five-year-old” children (with a mean age of 5;04) and found significantly above-chance performance on these verbs. Likewise, AoAs with two age groups (e.g., between three and four years old in [Table 2.6](#)) are a consequence of studies collapsing across those two age groups. An AoA could not be determined for a verb if there were no studies in which (i) that verb was tested and (ii) children showed successful performance on that verb.

Of the 50 unique verbs tested in these 12 studies, 30 had an AoA by this definition, as shown in [Table 2.6](#).³⁷

³⁷For the verbs *hug* and *chase*, [O’Brien et al. \(2006\)](#) reported conflicting results where three-year-old children in their study failed to comprehend long verbal passives in experimental contexts where there was only one possible Agent. Because the results of [O’Brien et al. \(2006\)](#) have not been replicated, the AoAs assigned to *hug* and *chase* in [Table 2.6](#) are maintained (see [Nguyen and Snyder \(2017\)](#); [Deen et al. \(2018\)](#) for discussion of why [O’Brien et al.’s \(2006\)](#) results should be doubted.)

Table 2.6: AoA of verbs from the synthesis of experimental studies, representing an AoA by 3 years old (3yr), between 3 and 4 years old (3-4yr), between 4 and 5 years old (4-5yr), and 5 years old (5yr).

AoA	Verbs
3yr	<i>carry, drop, eat, hold, hug, kick, kiss, push, shake, wash</i>
3-4yr	<i>annoy, chase, frighten, hit, pat, pull, scare, shock, squash, surprise, upset</i>
4-5yr	<i>find, fix, forget, paint, spot</i>
5yr	<i>hate, like, love, remember</i>

2.4.3 Annotations of Lexical Semantic Features

In order to test whether the lexical semantic proposals that were described in Section 2.3.4 can account for each verb’s AoA in Table 2.6, these verbs need to be annotated for their lexical semantic features (e.g., whether *carry* is +ACTIONAL). These annotations will help us evaluate the predictions of each of the proposals on how children’s behavior is impacted by the lexical meaning of the verbs used in passive voice.

A demonstration of how verbs were annotated for the lexical semantic features is shown in Table 2.7. These annotations were done in accordance with the signals identified in Table 2.4.³⁸ So, *find* is an observable action (ACTIONAL = 1, STATIVE = 0) that is not deliberate (VOLITIONAL = 0). In a transitive use, the direct object is unaffected (AFFECTED = 0) and a Patient (OBJ-EXP = 0, SUBJ-EXP = 0, AGT-PAT = 1). *Carry* is also an observable action (ACTIONAL = 1, STATIVE = 0), but can be deliberate (VOLITIONAL = 1). In a transitive use, the direct object is affected (AFFECTED = 1) and a Patient (OBJ-EXP = 0, SUBJ-EXP = 0, AGT-PAT = 1). *Love* is a STATIVE psych verb (ACTIONAL = 0, STATIVE = 1) that is not deliberate (VOLITIONAL = 0). In a transitive use, the direct object is unaffected (AFFECTED = 0) and the subject is the Experiencer (OBJ-EXP = 0, SUBJ-EXP = 1, AGT-PAT = 0).

The 30 verbs from Table 2.6 that were identified to have an AoA were annotated for their lexical semantic features according to the signals defined in Table 2.4. These annota-

³⁸For ease of exposition, the +/- signals used in Table 2.4 will be converted to 1s and 0s respectively. They are semantically equivalent in these annotations. But when discussing the actual features in the text, I will continue to use the +/- signals.

Table 2.7: Example reasoning for identification of lexical semantic features in the verbs *find*, *carry*, and *love*.

	<i>find</i>	<i>carry</i>	<i>love</i>
ACTIONAL	<i>find</i> ≠ mental, psych, or perception verb. 1	<i>carry</i> ≠ mental, psych, or perception verb. 1	<i>love</i> = psych verb. 0
STATIVE	*Alex finds Emma. 0	*Alex carries Emma. 0	Alex loves Emma. 1
VOLITIONAL	*Alex deliberately finds Emma. 0	Alex deliberately carries Emma. 1	*Alex deliberately loves Emma. 0
AFFECTED	Alex finds Emma – Emma is unaffected. 0	Alex carries Emma – Emma is affected. 1	Alex loves Emma – Emma is unaffected. 0
OBJ-EXP	Alex finds Emma. Alex = Agent. Emma = Patient. 0	Alex carries Emma Alex = Agent. Emma = Patient. 0	Alex loves Emma Alex = Experiencer. Alex = Subject. 0
SUBJ-EXP	0	0	1
AGT-PAT	1	1	0

tions are summarized in Table 2.8 below for all 30 verbs.

2.4.4 No Single Theory Can Cover Them All.

Now that we know which verbs have been tested on English-speaking children, at what age children begin to succeed on these verbs in the verbal passive, and the lexical semantic features of the verbs, we can evaluate whether the lexical semantic proposals described in Section 2.3.4 can (or cannot) account for the lexical asymmetry observed in Table 2.8. We will see that each of the proposals on its own cannot cover the full range of data that have been observed in children’s performance on the passive. The following section will be divided by the major lexical semantic proposals (ACTIONALITY, AFFECTEDNESS, STATIVITY & VOLITIONALITY, and Thematic Role Relations).

ACTIONALITY. As defined by Maratsos et al. (1985), verbs that are +ACTIONAL (i.e., verbs that denote an observable event) should be easier in the passive than –ACTIONAL

Table 2.8: Lexical semantic annotations for the 30 verbs that have a derivable AoA from the synthesis of experimental studies. Double lines indicate a difference in the featural pattern within each age group.

	Lexical Semantic Features						
	ACTIONAL	AFFECTED	STATIVE	VOLIT.	OBJ-EXP	SUBJ-EXP	AGT-PAT
Verb	3yr						
<i>carry</i>	1	1	0	1	0	0	1
<i>drop</i>	1	1	0	1	0	0	1
<i>eat</i>	1	1	0	1	0	0	1
<i>hold</i>	1	1	0	1	0	0	1
<i>hug</i>	1	1	0	1	0	0	1
<i>kick</i>	1	1	0	1	0	0	1
<i>kiss</i>	1	1	0	1	0	0	1
<i>push</i>	1	1	0	1	0	0	1
<i>shake</i>	1	1	0	1	0	0	1
<i>wash</i>	1	1	0	1	0	0	1
	3-4yr						
<i>chase</i>	1	1	0	1	0	0	1
<i>hit</i>	1	1	0	1	0	0	1
<i>pat</i>	1	1	0	1	0	0	1
<i>pull</i>	1	1	0	1	0	0	1
<i>squash</i>	1	1	0	1	0	0	1
<i>annoy</i>	0	1	1	1	1	0	0
<i>frighten</i>	0	1	1	1	1	0	0
<i>scare</i>	0	1	1	1	1	0	0
<i>shock</i>	0	1	1	1	1	0	0
<i>surprise</i>	0	1	1	1	1	0	0
<i>upset</i>	0	1	1	1	1	0	0
	4-5yr						
<i>fix</i>	1	1	0	1	0	0	1
<i>paint</i>	1	1	0	1	0	0	1
<i>find</i>	1	0	0	0	0	0	1
<i>forget</i>	0	0	0	0	0	1	0
<i>spot</i>	0	0	0	0	0	1	0
	5yr						
<i>hate</i>	0	0	1	0	0	1	0
<i>like</i>	0	0	1	0	0	1	0
<i>love</i>	0	0	1	0	0	1	0
<i>remember</i>	0	0	1	0	0	1	0

verbs (i.e., mental, psych, perception verbs). In Figure 2.3 below, +ACTIONAL verbs are marked in green while -ACTIONAL verbs are marked in red. Relying on the +/-ACTIONAL distinction alone would not be able to account for the early success of verbs like *annoy*, *frighten*, *scare*, *shock*, *surprise*, and *upset* which are all mental state verbs and thus non-ACTIONAL (Messenger et al., 2012).

Figure 2.3: Predictions by Theory - ACTIONALITY across AoA (Maratsos et al., 1985). Dashed line demarcates the predicted boundary in children’s behavioral performance. Verbs in green are predicted to be earlier than verbs in red.

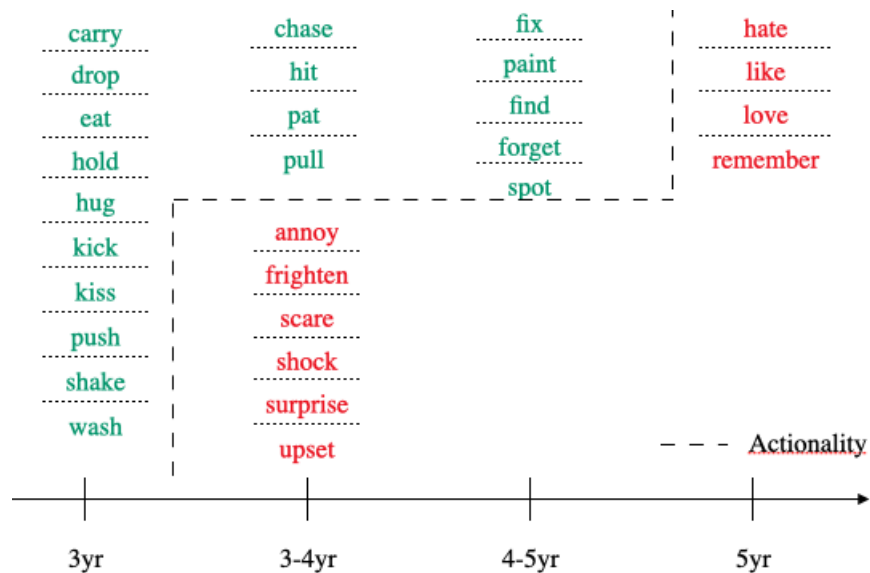

AFFECTEDNESS. For Pinker et al. (1987), verbs that are +AFFECTED (i.e., verb’s internal argument is affected) should be easier in the passive than -AFFECTED verbs (i.e., verb’s internal argument is unaffected). In Figure 2.4, +AFFECTED verbs are marked in green while -AFFECTED verbs are marked in red. Relying on the +/-AFFECTED distinction alone would predict a similar level of difficulty between verbs like *find*, *forget*, *spot* and verbs like *hate*, *like*, *love*, *remember*. This does not seem to be the case as the former set of verbs have an earlier AoA than the latter set of verbs (Liter et al., 2015).

STATIVITY & VOLITIONALITY. Liter et al. (2015) suggested that the order of children’s acquisition can be characterized in terms of STATIVITY and VOLITIONALITY such that

Figure 2.4: Predictions by Theory - AFFECTEDNESS across AoA (Pinker et al., 1987). Dotted line demarcates the predicted boundary in children’s behavioral performance. Verbs in green are predicted to be earlier than verbs in red.

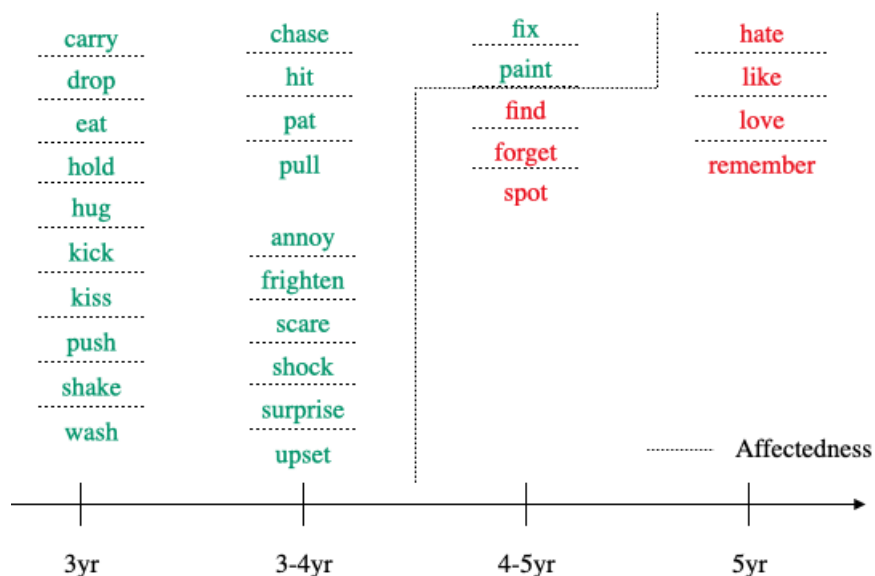

verbs that are -STATIVE, +VOLITIONAL (in green in Figure 2.5) are acquired before -STATIVE, -VOLITIONAL (in blue), and that +STATIVE, -VOLITIONAL verbs (in red) would be the latest acquired. The early success of verbs like *annoy*, *frighten*, *scare*, *shock*, *surprise*, and *upset* is unaccounted for by this theory as these OBJECT-EXPERIENCERS do not fall under any of the three classes discussed (Messenger et al., 2012).

Thematic Roles. Messenger et al. (2012) make a distinction between +AGENT-PATIENT, +OBJECT-EXPERIENCER, and +SUBJECT-EXPERIENCER verbs such that they predict comparable performances on +AGT-PAT and +OBJ-EXP verbs (marked in green in Figure 2.6) and +SUBJ-EXP are predicted to be hardest for young children. So far, the predictions of this proposal are seemingly borne out in Figure 2.6 as +SUBJ-EXP verbs do indeed have the latest AoA. But Messenger et al. treat +AGT-PAT verbs as a homogenous group and thus cannot account for why verbs like *find*, *forget*, and *spot* would have a later AoA than other +AGT-PAT verbs like *chase*, *hit*, and *pat* (Liter et al., 2015).

Figure 2.5: Predictions by Theory - STATIVITY & VOLITIONALITY across AoA (Liter et al., 2015). Solid line demarcates the predicted boundary in children’s behavioral performance. Verbs in green are predicted to be earlier than verbs in blue and verbs in red. Verbs in grey are unaccounted for by the theory.

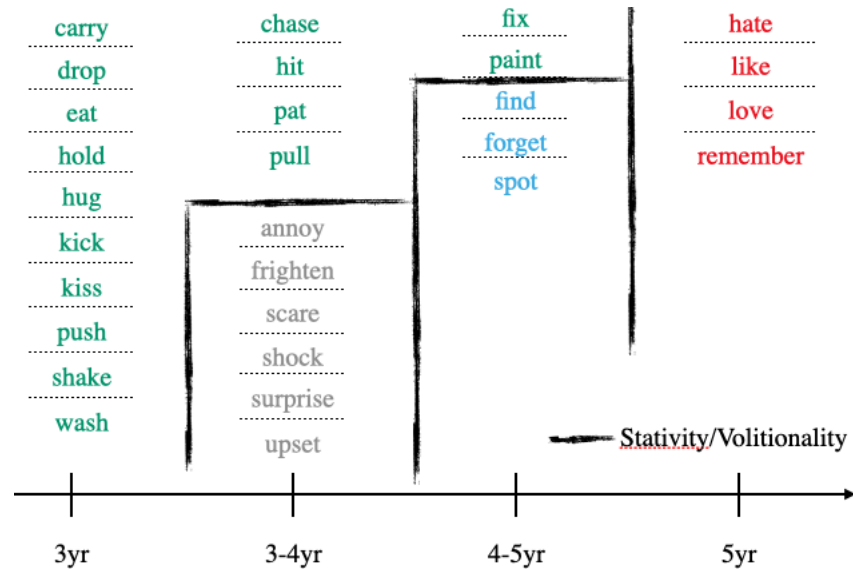
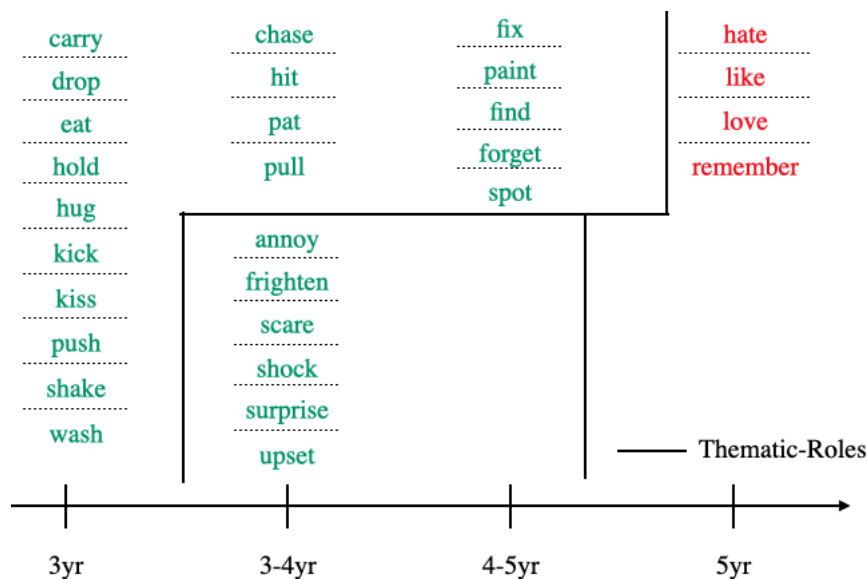

Figure 2.6: Predictions by Theory - Thematic Role Relations across AoA (Messenger et al., 2012). Solid line demarcates the predicted boundary in children’s behavioral performance. Verbs in green are predicted to be earlier than verbs in red.



All theories. Putting the lexical semantic proposal predictions together, we get a picture similar to Figure 2.7. We can see that these proposals are not terminological variants of each other (as indicated by the non-overlapping demarcations on the figure). Further-

more, each of these proposals is unable to account for the full range of AoAs that was gathered from the synthesis of experimental studies. Table 2.9 draws out the different predictions of each of these proposals for a smaller set of verbs, *carry*, *search*, *annoy*, and *love*.

In order to account for all of the AoAs derived from the synthesis of experimental studies, I propose to treat these lexical semantic features as features that are independent from each other and thus ones that can be combined together into various groupings.

Figure 2.7: Predictions by All Theories.

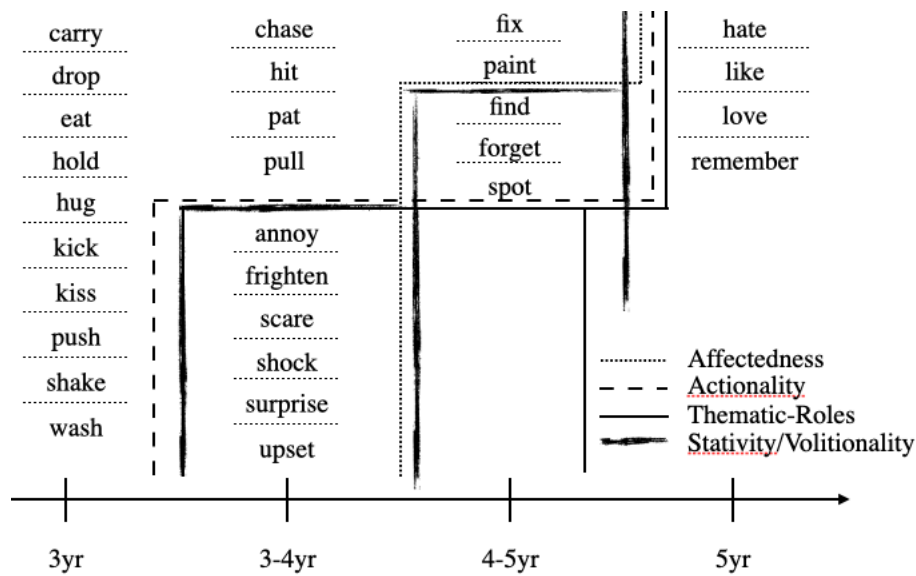

Table 2.9: Example predictions of children’s performance on the passives of *carry*, *search*, *annoy*, and *love* by each lexical semantic proposal.

	Actionality	Affectedness	Stativity, Volitionality	Thematic-Roles
<i>carry</i>	✓	✓	✓	✓
<i>search</i>	✓	×	✓	✓
<i>annoy</i>	×	✓	–	✓
<i>love</i>	×	×	×	×

2.4.5 Limitations of the synthesis of experimental studies

The synthesis of experimental studies leaves open several questions. I will briefly summarize these questions but will go into further details in Section 4.1.2 in Chapter 4 where

I address all of these limitations with a behavioral assessment using a Truth-Value Judgment Task. First, because there is often an age overlap in the age groups tested, we do not know exactly how four-year-olds would perform compared to the three- or five-year-olds; it is possible that four-year-old children have a distinct performance pattern with respect to these different verbs. Second, only one study in the synthesis of experimental studies, [Messenger et al. \(2012\)](#), has tested +OBJ-EXP verbs in young children and thus it is unclear if the age of acquisition of the long verbal passives for +OBJ-EXP verbs like *annoy* is in fact by four years of age in English. Third, verbs with multiple AoAs that are part of the same lexical semantic profile are predicted by the Lexical Semantic Profile Hypothesis to be acquired by the earliest observed AoA for this profile. Fourth, the synthesis of experimental studies combines the results from different groups of children across multiple age ranges using different experimental stimuli and methods (see [Table 2.5](#) for the different methods). So, the differences in methodologies could impact the observed AoAs, and thus any observed patterns in children's performance with regards to verb type.³⁹ More generally, any characterization of the passive lexical asymmetry would be strengthened if the same group of children performed as predicted by the synthesis of experimental studies across a variety of verbs with different lexical semantic features. In a Truth Value Judgment Task described in [Chapter 4](#), I address these limitations and predictions by testing the same group of children on the same test stimuli. The results from this experiment will therefore increase the empirical foundation provided by the synthesis of experimental studies, by assessing four-year-old English-speaking children's comprehension behavior on a variety of verbs from different sets of lexical semantic features.

³⁹Additionally, it is a limitation of this synthesis of experimental studies to exclude studies that included experimental manipulations that are predicted to increase children's accuracy rates (e.g., repetition of test sentences, [Deen et al. \(2018\)](#)). Because the goal is to establish a lower bound of when children understand the passive of particular verbs, I leave to future work to investigate how the lexical asymmetry can be re-characterized when issues regarding children's deployment of knowledge (i.e., processing constraints either due to pragmatic or other reasons) are minimized.

2.5 Lexical Semantic Profile Hypothesis

While it is uncontroversial that there is an interaction between children’s behavioral performance on a particular verb in the passive and the lexical meaning of that verb, it is an empirical question of how and which lexical semantic features matter for children. Up until this point, we have seen that each of the major lexical semantic proposals on their own cannot account for the full range of verbs in the long passive that have been tested on English-speaking children. Instead, I would like to propose that we can treat these lexical semantic features as equally and independently informative ways of differentiating verbs from each other. Specifically, I will combine all seven features together in order to establish finer-grained verb classes into which to divide up the verbs of interest.

2.5.1 Lexical Semantic Profiles

When the 30 verbs in Table 2.8 are sorted based on observed AoA (i.e., the age of significantly above-chance performance from the synthesis of experimental studies), there is a striking relationship between the combination of lexical semantic feature values of a verb (which I will call its “lexical semantic profile”) and that verb’s observed AoA (see Table 2.10). In particular, each of the 30 verbs in Table 2.6 can be categorized into one of five unique lexical semantic profiles, with verbs in the same lexical semantic profile having exactly the same feature values, and verbs in a particular feature value having the same AoA.⁴⁰

Profile 1 verbs like *carry*, *chase*, and *fix* all have the same lexical semantic feature annotations because they all are +ACTIONAL, +VOLITIONAL, +AFFECTED, and +AGT-PAT. Profile 2 verbs like *annoy* differ from Profile 1 verbs in being +STATIVE (rather than +ACTION-

⁴⁰I have labeled these lexical semantic profiles with an Arabic numbering system because they were named in the order that appear the earliest in the developmental trajectory. There is some predictive power in the labels in that the lexical semantic profile hypothesis would predict profiles with a smaller number to be acquired earlier than profiles would a higher number. So when comparing Profiles 1 and 3, we would predict Profile 1 to be earlier, and likewise would predict Profile 3 to be not earlier.

Table 2.10: Lexical semantic profiles comprised of the seven lexical semantic features for example verbs with different experimentally observed ages of acquisition (AoA).

Profile	AoA						
	3yrs	3-4yrs		4-5yrs			5yrs
	<i>carry</i>	<i>chase</i>	<i>annoy</i>	<i>fix</i>	<i>find</i>	<i>forget</i>	<i>hate</i>
	1	1	2	1	3	4	5
ACTIONAL	1	1	0	1	1	0	0
STATIVE	0	0	1	0	0	0	1
VOLITIONAL	1	1	1	1	0	0	0
AFFECTED	1	1	1	1	0	0	0
OBJ-EXP	0	0	1	0	0	0	0
SUBJ-EXP	0	0	0	0	0	1	1
AGT-PAT	1	1	0	1	1	0	0

AL) and +OBJ-EXP (rather than +AGT-PAT). Profile 3 verbs like *find* are like Profile 1 verbs in being +ACTIONAL and +AGT-PAT, but differ in being –VOLITIONAL and –AFFECTED. Profile 4 verbs like *forget* are like Profile 3 verbs in being –STATIVE, –VOLITIONAL, and –AFFECTED, but differ in also being –ACTIONAL and +SUBJ-EXP. Profile 5 verbs like *hate* are like Profile 4 verbs in being +SUBJ-EXP, but are additionally +STATIVE. When we evaluate all 30 verbs that have an AoA based on these five lexical semantic profiles, we get the classification as shown in Table 2.11.

2.5.2 Developmental Trajectory

Taken all together, these profiles suggest a natural developmental trajectory for the lexical semantic cues that influence children’s ability to interpret long verbal passives. We can formulate a hypothesis where children’s behavioral performance on the verbal passive can be predicted by the ordering of these lexical semantic profiles (which I will refer to as the “(PASSIVE) LEXICAL SEMANTIC PROFILE HYPOTHESIS”). It is important to note that the ages associated with the predicted developmental trajectory are derived from the synthesis of experimental studies of English-speaking children’s performance; for our purposes, these ages serve simply to indicate the relative order that profiles should emerge in. The predicted developmental trajectory corresponding to English-speaking children’s ages is

Table 2.11: Observed age of acquisition (AoA) for the 30 verbs with an AoA available from the synthesis of experimental studies, along with their lexical semantic profile (Profile).

AoA	Verb	Profile	AoA	Verb	Profile
3	<i>carry</i>	1	3-4	<i>annoy</i>	2
3	<i>drop</i>	1	3-4	<i>frighten</i>	2
3	<i>eat</i>	1	3-4	<i>scare</i>	2
3	<i>hold</i>	1	3-4	<i>shock</i>	2
3	<i>hug</i>	1	3-4	<i>surprise</i>	2
3	<i>kick</i>	1	3-4	<i>upset</i>	2
3	<i>kiss</i>	1	4-5	<i>fix</i>	1
3	<i>push</i>	1	4-5	<i>paint</i>	1
3	<i>shake</i>	1	4-5	<i>find</i>	3
3	<i>wash</i>	1	4-5	<i>forget</i>	4
3-4	<i>chase</i>	1	4-5	<i>spot</i>	4
3-4	<i>hit</i>	1	5	<i>hate</i>	5
3-4	<i>pat</i>	1	5	<i>like</i>	5
3-4	<i>pull</i>	1	5	<i>love</i>	5
3-4	<i>squash</i>	1	5	<i>remember</i>	5

shown in Table 2.12. We can interpret these lexical profiles as corresponding to five classes of verbs and the developmental trajectory that we see involves children comprehending successively larger supersets of these five classes (such that English-speaking three-year-olds understand the first profile and five-year-olds understand all five).

Table 2.12: AoA predictions (Predicted AoA) for example verbs in English, based on their lexical semantic profiles (Profile).

Profile	Example verbs	Predicted AoA
1	<i>bump, crash, fix, chase, hug</i>	3yrs
2	<i>flatter, hurt</i>	3-4yrs
3	<i>search, discover</i>	4-5yrs
4	<i>spot, notice, overhear</i>	4-5yrs
5	<i>believe, miss, know, remember</i>	5yrs

2.5.3 Predictions

For the discrepancies between the lexical semantic profiles for some verbs and the observed AoA (e.g., Profile 1 verb *fix* with an observed AoA of 4-5yrs in Table 2.11), the LEXICAL SEMANTIC PROFILE HYPOTHESIS would predict that these are because children

were not tested at the relevant lower age for those verbs. For example, the verb *fix* has only been tested once by [Liter et al. \(2015\)](#) whose youngest participants were four- to five-year-olds. But since *fix* is a Profile 1 verb and Profile 1 verbs are predicted to have an AoA of 3yrs (see [Table 2.12](#)), the LEXICAL SEMANTIC PROFILE HYPOTHESIS would predict above-chance performance for *fix* in the long verbal passive if three-year-old children were tested. Moreover, the LEXICAL SEMANTIC PROFILE HYPOTHESIS would be able to go beyond the 30 verbs in [Table 2.11](#) and make predictions for the AoA of never-before-tested verbs given the lexical semantic profile of that verb. For example, *believe*, which is a Profile 5 verb but has never been tested in the passive, is predicted to have an AoA of 5 years (see [Table 2.12](#)). The predictions of the relative ordering of the lexical semantic profiles along with some other concerns about the conducted synthesis of experimental studies (see [Section 4.1.2](#)) are examined in a behavioral study that I discuss in [Chapter 4](#).

2.6 Summary

In this chapter, I have introduced the English verbal passive as our case study for investigating how children acquire language. Specifically, this dissertation will examine the lexical semantic asymmetry often observed in English-speaking children’s performance on long verbal *be*-passives. I first presented some theoretical background on the structural representation of the passive and the set of verbs that allow passivization with a specific focus on English. I then looked at previous language acquisition research that has tried to pinpoint children’s linguistic knowledge of the passive. I have highlighted various proffered accounts for how children’s grammatical knowledge may be different from the target adult system. This included discussion of three major lexical semantic proposals that attempted to characterize the lexical semantic asymmetry in children’s linguistic performance. In a synthesis of experimental studies on English-speaking children’s understanding of verbal passives at certain ages, I was able to determine an age of acquisition (AoA) — the earliest age when children begin to how successful comprehension — for 30 verbs

that have been tested in the verbal passive. I then demonstrated that based on the coarse description of the major lexical semantic proposals, most of these theories by themselves do not seem to readily explain the AoA of the verbs derived from the experimental metal-analysis. Ultimately, I proposed that what is impacting children's performance is a collection or combination of lexical semantic features, rather than only one or two features, which I refer to as the "lexical semantic profile" of a verb. When we examine children's lexical verb asymmetry through the lens of these lexical semantic profiles, there seems to be a natural developmental trajectory of the relative ordering of when verbs of certain profiles are acquired by children in the long verbal passive. I refer to this idea that different lexical semantic profiles are impacting children differently at different ages leading to the observed developmental trajectory as the LEXICAL SEMANTIC PROFILE HYPOTHESIS.

The main focus of this dissertation will be investigating and validating the LEXICAL SEMANTIC PROFILE HYPOTHESIS and the developmental trajectory that we have observed for English-speaking children's behavior. We will approach this investigation by examining the three major research questions that I have laid out in Chapter 1, which are repeated below:

- Q1** What kinds of evidence are available to children in their input? How much evidence of various types are children receiving?
- Q2** What is the nature of children's linguistic knowledge and their capacity to deploy that knowledge during the course of development?
- Q3** What is a precise theory of how children harness evidence from their input to acquire sophisticated linguistic knowledge?

In the next chapter, I will provide empirical research that addresses **Q1** by conducting a corpus analysis of child-directed speech.

3 | The Children’s Learning Environment⁴¹

3.1 Introduction

It is incontrovertible that linguistic input is a necessary requirement for successful language acquisition. The exact nature of the language environment has been the center of intense debates ranging from: (i) what kinds of evidence are available to the child in her input, (ii) how much evidence of various types are children receiving, (iii) how the child makes use of that evidence, and (iv) whether the child comes with innately-specified knowledge of grammatical principles and language-specific mechanisms for acquisition (Babyonyshev et al., 2001; Borer and Wexler, 1987, 1992; Chomsky, 1980; Crain, 1991; Crain and Thornton, 1998; Gleitman, 1981; Lightfoot, 1989; Rizzi, 1993; Wexler, 1991, 1994, 1996). (i) and (ii) are questions about the observable linguistic input itself, which can be evaluated given corpora of child-directed speech; (iii) and (iv), on the other hand, are concerned with how much of the linguistic input is harnessed by children to acquire their grammar — which we can refer to as “intake” — and how the intake is impacted by factors internal to the child rather than changes in the child-directed speech (Fodor, 1998; Pearl and Lidz, 2009; Omaki and Lidz, 2015; Lidz and Gagliardi, 2015, a.o.). These debates are usually derived from a plethora of research and pervasive intuitions showing that some-

⁴¹The corpus analysis described in this chapter was work that I conducted while visiting the University of California, Irvine, under the supervision of Lisa Pearl in Spring 2016. This research has been presented at the following workshops and conferences: Computational Language Acquisition (CoLa) Laboratory at UCI, Experimental Syntax and Semantics Lab at MIT, Workshop on Passives at the University of Geneva, Linguistic Society of America Annual Meeting (LSA Annual Meeting 2017), Chicago Linguistic Society (CLS 53), Generative Approaches to Language Acquisition 2018 (GALANA-8), CompLang at MIT, Meaning and Modality Lab at Harvard University, and QuantLab at UCI. Parts of this chapter is based on [Nguyen and Pearl \(2018, 2019\)](#). I’d like to extend special thanks to Galia Bar-sever and Bahareh Nofereest for assistance with corpus annotations.

times the observable linguistic behavior that we see in children is surprising based on the input that they receive and how we think they're using that input (i.e., children's intake of the input). This can mean that either children's linguistic knowledge is seemingly early despite a seemingly impoverished input or that children's linguistic knowledge is seemingly delayed despite a seemingly rich input. Chomsky (1980) characterized this difference as the problem of the "poverty of the stimulus" and the problem of the "abundance of the stimulus" respectively.

Understanding the reality of the learning environment is important because different learning mechanisms can be assumed depending on the nature of the child's input. If a child faces a problem of the poverty of the stimulus where the data are insufficient on their own to overcome the learning task, the child is assumed to have some prior knowledge and/or abilities that guide her. Theories of the learning mechanism in this situation focus on the nature of that prior knowledge and/or abilities (e.g., innate grammatical knowledge vs. derived from prior experience, language-specific vs. domain-general). If, however, a problem of the abundance of the stimulus is encountered, the data in the input are available and would be sufficient (under a specific theory of how children use their input to learn) but the child does not (or possibly cannot) harness that information. Therefore, theories of the learning mechanism in this situation focus on the nature of how children are filtering and harnessing the information in their input (e.g., maturation of knowledge structures vs processing constraints). Because the learning environment type implicitly assumes different theories of the learning mechanism, it is important to quantify and understand the evidence available to the child. Furthermore, assessing whether the linguistic input to children is impoverished or rich depends on what is considered to be evidence in the first place, which is needed — and just as importantly must be harnessed — by children for successful language acquisition.

3.1.1 Quantifying Evidence from the Input

It is reasonable to assume that, for any given learning task, only a subset of the input serves as potential evidence for children. Thus, before we can consider the available evidence to children as either sufficient, impoverished, or abundant in the input, we first need to determine what the child is trying to learn and what evidence is needed to arrive at the target adult grammar. For example, let's say that a child hears her mother utter (3.1). If the child in question is at that time trying to learn the phonological system of her language, then she will entertain hypotheses about and draw upon evidence from the speech sounds that compose (3.1). It doesn't quite matter to this child that her mother had just uttered a passive sentence or that the sentence was used in a context to refer to characters on a TV show, although all of that information is available in the input. If, however, the child is at that time engaged in learning the syntax of passives in English, then the relevant evidence here will be in the syntactic form of (3.1) and its context (e.g., the mapping of thematic roles, pragmatic decisions to use this alternation, etc.). So, when we talk about quantifying evidence, it is relative to the specific learning task for the child and assumed to be a subset of the input in its entirety.

(3.1) Diana was chased by Matthew.

3.1.2 Differentiating Input from Intake

As mentioned before, a problem of the abundance of the stimulus has occurred when evidence needed to arrive at the target adult grammar is available in a sufficient quantity in the input and yet children's acquisition is seemingly delayed. One way of understanding the cause of such a delay is to appeal to the idea that children may be filtering their input. Because researchers are only able to assess the input that children are exposed to and their subsequent behavioral output, the nature of the child's intake (or what the child is able to harness from the input) is up for debate (Omaki and Lidz, 2015). Possible expla-

nations that are debated include immature grammatical knowledge (Borer and Wexler, 1987), processing constraints (Omaki and Lidz, 2015), and determining some evidence as more useful than others (Gagliardi et al., 2012). It is important to note that if a child is unable to harness the information available to her in the input (e.g., she cannot perceive the data available due to processing constraints), her learning environment is essentially impoverished. So, the problems of the poverty and abundance of the stimulus can be viewed as two sides of the same coin, with the difference being the learning mechanism that is focused on to explain a child's path to successful language acquisition. To better understand what drives successful language acquisition, we not only need to understand what input is available to children but also how children are utilizing that information (Chouinard and Clark, 2003; Clark, 2010).

3.1.3 Relationship Between Input and Acquisition

There are several ways to correlate the quality and quantity of input and what we might expect children's behavioral output to be. First, we might expect a direct relationship between the frequency of a construction in child-directed speech and when children acquire a particular piece of linguistic knowledge such that the higher the frequency of something in the input, the earlier the acquisition (Demuth, 1989). A direct relationship between input and acquisition can be seen in various domains, such as speech segmentation (Saffran et al., 1996), word-learning (Newport and Aslin, 2004; Smith and Yu, 2008), syntactic categorization (Mintz, 2006; Lany and Gómez, 2008), among others.⁴² Second, we might expect no or little relationship between children's input and children's behavior for some particular learning problem. In this case, the child's learning environment is argued to be impoverished and children have to rely on innate grammatical principles and mechanisms to acquire the necessary linguistic knowledge (Chomsky, 1980). While

⁴²It can still be argued that what matters for these learning problems is children's filtered intake of the input but perhaps the relationship between input and language acquisition is more direct for the learning problems named here than other types of learning problems (e.g., other domains of syntax, other domains of semantics).

there is no doubt that the linguistic input matters for acquisition (particularly for points of cross-linguistic variation), it is an empirical question of what type of evidence needs to be frequent for children (i.e., the quality of the input) and how much of this evidence is needed (i.e., the quantity of the input). I will discuss more about some of these input-based hypotheses in Section 3.2.2.

3.1.4 Investigating the Learning Environment for the Passive

In this chapter, I will explore what children's learning environment can tell us about why children exhibit the lexical verb asymmetry that they do with the English verbal passive. Specifically, I will investigate whether there is a direct relationship between the developmental trajectory that is observed in children's performance on the passive and the type of evidence that is present in children's linguistic input. To this end, I will first describe previous research that has looked at frequency of passives in production in both children and adults. I will then describe a fine-grained corpus analysis of child-directed speech in order to assess whether there is a relationship between a verb's demonstrated age of acquisition (AoA) that was previously established in Chapter 2 and the frequency of that individual verb in the input; I do not find such a direct relationship between individual verbs in the passive and the verb's observed AoA. Because there appears to be a natural developmental trajectory of children's acquisition of the English verbal passive based on previously proposed lexical semantic features, I additionally investigate the distribution of these features in children's linguistic input. I will conclude this chapter by discussing how the frequency of lexical semantic features can play a role in building a potential learning story for children's acquisition of the passive.

3.2 Passives in Production

From an input point-of-view, it may be unsurprising that children exhibit (seemingly) late knowledge of passives, as it has been claimed that long passives rarely appear in the

child's parental input (Gordon and Chafetz, 1990; Crain and Fodor, 1989). It is still a useful exercise to examine what has previously been considered to be evidence for children's acquisition of the verbal passive (namely passives themselves) and how rare this evidence actually is in the linguistic input. I will first summarize passive usage in child-directed speech before discussing some proposals of what kinds of evidence in the linguistic input we can consider for children's acquisition of the passive, particularly with respect to how they may explain the lexical verb asymmetry that we observe for children's behavior. This discussion of the previous literature will provide the starting point for our investigations into children's learning environment with regards to the passive and motivates the corpus analysis discussed in Section 3.3.

3.2.1 Passive Usage in Child-Directed Speech

There have been several investigations examining the prevalence of passives in child-directed speech in English, and these studies have generally found passives to be vanishingly rare especially when compared to the use of active sentences (e.g., Brown, 1973; Svartvik, 1966). Maratsos et al. (1985) noted that out of 101 "possible" passives that were found in child-directed speech derived from 37.5 hours of naturalistic parent-child interactions, only one passive contained a *by*-phrase. Furthermore, while these possible passives were formed from a diverse set of verbs including AGENT-PATIENT verbs (e.g., *attach*, *bend*, *bite*) and OBJECT-EXPERIENCER verbs (e.g., *scare*, *surprise*, *irritate*), Maratsos et al. reported no SUBJECT-EXPERIENCER verbs (e.g., *know*, *forget*, *see*), suggesting that children are receiving evidence of passives in their input from verbs with a restricted semantic range.⁴³ It has also been reported that children tend to hear more short passives than long passives in their input (Svartvik, 1966). Gordon and Chafetz (1990) examined 86,655 child-directed utterances to three children (Brown, 1973, Adam, Eve and Sarah;) from the

⁴³Maratsos et al. (1985) referred to these verbs in terms of eventive and stative verbs. For ease of exposition, I am using the lexical feature terms that separate verbs based on thematic-role relations which were first introduced in Chapter 2.

CHILDES database (MacWhinney, 2000). Overall, they identified 313 tokens of passive utterances of any kind, which yielded a rate of passives-per-utterance of 0.36%, and only four long passive utterances. Looking at only verbal passives, Gordon and Chafetz found 91 tokens that represented 56 types of short passives, which is a passives-per-utterance rate of 0.091%.⁴⁴

But despite the seemingly low frequency of passives in the production of adults and children (see Chapter 2), there are some proposals for how the linguistic input can still impact children's acquisition of the verbal passive. I give an overview of these hypotheses and their predictions in the next subsection.

3.2.2 Frequency-Based Hypotheses

Here, I will focus on different hypotheses of what kinds of evidence in the linguistic input (i.e., what is being counted to determine whether the input is abundant or impoverished) can be used by children to acquire the verbal passive and discuss how these hypotheses would explain the relationship between the passive lexical verb asymmetry and child-directed speech.

3.2.2.1 Counting Passives

Perhaps one straightforward account for how input affects children's acquisition of the verbal passive is counting how often children hear passives (of any kind) in their linguistic input. In trying to account for why Sesotho-speaking children start producing passives at a much earlier age (by at least 2;8 years) than English-speaking children, Demuth (1989) noted that Sesotho-speaking adults produce passives at a relatively high frequency. She reported in a four-hour corpus of child-directed speech in Sesotho that 6% of adult care-

⁴⁴Crain and Fodor (1989) and Gordon and Chafetz (1990) are often cited when discussing the frequency of passives in adult speech. But their discussion was in the context of speech to children. I leave for future work an analysis of the frequency of passives in adult-directed speech.

givers' utterances were passives, with 56% of those passives being long verbal passives.⁴⁵ Demuth proposed that the age at which children acquire passives relates directly to the rate at which the construction is used in the children's input. Thus, if passives are frequent in the input, children are predicted to acquire passives early like in Sesotho; but if passives are rare in the input, children are predicted to be delayed in their acquisition of the passive as is the case for English. This account was adopted by Allen and Crago (1996) to account for Inuktitut, where passive use is also highly frequent in adult speech and children seem to master the passive at an early age. I will refer to an account where children are reliant on the number of passives heard in their input as a "Frequency of Passives" account.

A modified version of Demuth's (1989) Frequency of Passives account was proposed by Lau (2011) to account for Cantonese-speaking children's early acquisition of the passive. While passives are infrequent in Cantonese child-directed speech (0.00002% of child directed utterances), Lau (2011) found good comprehension of *bei*-passives by Cantonese-speaking children. To account for this, she proposed that the consistency of passive input available to children is as important as the frequency of those passives. In Cantonese passives, the passive morpheme *bei* is obligatory. This contrasts with English passives, which may occur with or without a *by*-phrase. Lau argued that this consistency of the *bei* morpheme whenever passives appear in the linguistic input assists children in theta-role assignment, allowing them to identify the non-canonical order of the arguments.⁴⁶ This is in line with a "cue-based" approach argued by Sudhalter and Braine (1985) where the preposition *by* in the passive construction alerts the child to expect an Agent argument. Despite Sesotho having both long and short passives (and thus the passives themselves being inconsistent in form), Lau argued that the high frequency of the Sesotho passive in

⁴⁵Crawford (2005) comes to a different conclusion when examining the same dataset. She concludes that the Sesotho children's passive production is not as productive as originally claimed. In particular, she argued that children's long passive forms may reflect rote memorization.

⁴⁶However, *bei*-passives do not require an object, which may make it more difficult to use it as a cue for thematic role assignment. In this case, the consistency of *bei* in Cantonese passives acts as a reliable signal for a particular type of construction.

child-directed speech performs a similar function to the consistency of passives in Cantonese; thus, children are able to use their input in order to correctly assign thematic roles to all arguments in the passive. I will refer to this account as the “Consistency of Passives” account.

For both accounts, what is being counted in the input is passives as a construction by either overall frequency (Frequency of Passives account) or by how similar the syntactic forms of these passives are to each other (Consistency of Passives account). With regards to English-speaking children’s observed lexical verb asymmetry, the accounts that are concerned with the relative frequency of passives in the input would only be able to predict English-speaking children to be delayed in their acquisition of passives (relative to other languages). In particular, the Frequency of Passives account would predict English-speaking children to be delayed because passives overall are quite rare in English child-directed speech; the Consistency of Passives account would also predict this delay because English has more than one passive form (both short and long passives) and thus there would be no consistent cue for the passive. To put in terms of quality and quantity of evidence for children acquiring the passive, the evidence considered by children would be passive constructions as a whole. In particular, children are relying on the number of passives available in the linguistic input relative to sentences in the active voice, compared to children learning other languages.

3.2.2.2 Counting Verbs

One way to explain English-speaking children’s differing performance by specific verb on long verbal passives is a very direct one: Children hear some verbs in the passive form more than others, and so perform better on the verbs they hear more frequently in the passive. As we’ve seen so far in this section, English-speaking children and adults rarely produce long verbal passives (e.g., [Crain and Fodor, 1989](#)). Furthermore, it has been proposed that the verbs that adults produce in the passive may be limited in their semantic

range. As noted by [Maratsos et al. \(1985\)](#) in their informal study of child-directed speech, while there were passives of ACTIONAL verbs, there were no instances in which adult caregivers produced passives of SUBJECT-EXPERIENCER verbs (e.g., *hate, love, forget*). It is these verbs that children have the most difficulty in comprehending in the passive in their studies. So, children's passive performance by verb could simply be a direct reflection of the frequency of passives of particular verbs in the linguistic input. I will refer to an account where there is a direct relationship between the frequency of individual passive verbs in the input and children's acquisition of the verbal passive as the "Verb-By-Verb" account.

Such an account perhaps would assume that the passive is acquired and represented on individual verbs within the lexicon, which is compatible with linguistic theories that separate lexical representations for active and passive forms of verbs ([Bresnan, 1982](#); [Gazdar et al., 1985](#); [Tomasello, 1992](#); [Ambridge et al., 2011](#)). If children are initially acquiring passives of ACTIONAL verbs that they have previously heard before as passives in their linguistic input, then we should see greater difficulty with passives of verbs that they have not heard before as passives, which in this case may be these specific non-ACTIONAL verbs that children have yet to encounter in their input. [Gordon and Chafetz \(1990\)](#) conducted a corpus analysis of English child-directed speech and a comprehension study with English-speaking children in order to test the predictions of such a verb-based account. They found that verbal passives of non-ACTIONAL verbs were indeed rarely produced by adult caregivers (as compared to verbal passives of ACTIONAL verbs) and that children show consistency in their behavior with regards to which verbs they do and do not comprehend in the passive.⁴⁷ If individual verb passive frequency (i.e., the frequency of a verb used in the passive) is a core factor driving children's performance, we would expect children's input to be strongly correlated with their behavior. In particular,

⁴⁷[Gordon and Chafetz \(1990\)](#) noted that while their results are in line with the prediction of a Verb-by-Verb account, they do not discount the proposal that children are acquiring passives by semantic class rather than by individual verb (see Section 3.2.2.3).

we would expect a verb's passive frequency in the input to be strongly correlated with children's performance on that verb: the more passive input there is for a verb, the better performance should be on that verb.

An alternative hypothesis would be one based not on individual verb passive frequency, but rather simply individual verb frequency. The idea here would be that the passive is a more difficult structure for children to process and so verbs that are themselves easier to access are the ones children perform better on in the passive. That is, the difficulty is not with the passive structure *per se*, but rather with deploying knowledge of the passive in real time for an individual verb (Omaki and Lidz, 2015). So, when a verb itself is more accessible, that verb will be easier for children to understand in the passive form. One way that a verb could be more accessible is through exposure to that verb in the input, in any of its forms (active or passive). Under this view, the more frequent a verb is in children's input in any of its forms, the better children's performance on the passive should be. I will refer to this hypothesis as the "Overall Verb Frequency" account.

3.2.2.3 Counting Features

We can look beyond individual verbs and see whether there are commonalities between verbs in the linguistic input that may impact children's behavior. That is, is there a relationship between the frequency of a class of verbs and when children acquire that set in the passive? The motivation for such a class-based hypothesis is that children's differing behavior with regards to the passive can often be characterized as an asymmetry based on the lexical semantics of the verbs (e.g., the ACTIONAL/non-ACTIONAL distinction, Maratsos et al. 1985). Additionally, the significance of lexical semantic features is also suggested by the LEXICAL SEMANTIC PROFILE HYPOTHESIS, which I introduced in Chapter 2. I will refer to this type of hypothesis as the "Individual Lexical Semantic Features" account. According to this type of account, a possible explanation for why children have no difficulty with passives of ACTIONAL verbs is that they hear more instances of passives from this

category in their input compared to passives of non-ACTIONAL verbs. The relatively high frequency of passives of ACTIONAL verbs in child-directed speech is corroborated by separate corpus analyses by Maratsos et al. (1985) and Gordon and Chafetz (1990). They both also found few to no instances of passives of non-ACTIONAL verbs where the Experiencer is the grammatical subject (i.e., SUBJECT-EXPERIENCER verbs) in children’s input, which is predicted if children’s behavior on passives is impacted by the frequency of verb classes heard in the passive.

There are several proposals in the literature as to why a high frequency of passives of ACTIONAL verbs in the linguistic input may lead to children’s early success with these verbs. Maratsos et al. (1985) proposed that children may initially hypothesize that passives are restricted to verbs that are high in “semantic transitivity” such as *break* and *hit* (Hopper and Thompson, 1980).⁴⁸ Children’s incorrect hypothesis would be further strengthened by the lack of passives of verbs that are less “semantically transitive” (i.e., SUBJECT-EXPERIENCER) in their input. Sudhalter and Braine (1985) proposed that the high frequency of passives of ACTIONAL verbs leads to early success because the preposition *by* can act as a “cue” for children to expect an Agent argument. They argued that because the external argument in non-ACTIONAL passives is not an Agent (they can be Themes or Experiencers), there is little consistency for what the preposition *by* can cue. Without a consistent cue, children are further delayed in acquiring passives of non-ACTIONAL verbs due to low frequency in the input. Pinker et al. (1987) suggested that children’s problems with non-ACTIONAL passives may have been the result of a cautious early generalization of only allowing passivization for AGENT-PATIENT verbs. In their study, English-speaking children were taught novel (i.e., nonce) verbs, and they were more likely to produce passives of verbs that were taught to them in the passive voice than verbs that were taught in the active voice (and thus required children to make a generalization of how passiviz-

⁴⁸In a spirit similar to the lexical semantic profiles introduced in Chapter 2, “semantic transitivity” separates verbs based on a collection of properties relating to the ANIMACY, DEFINITENESS, VOLITIONALITY, and AFFECTEDNESS of the verbs’ arguments (Hopper and Thompson, 1980).

able a verb should be based on the lexical meaning of the verb in the active voice). This tendency in children's behavior occurred regardless of the lexical meaning of the verb, suggesting that children are strongly impacted by positive evidence of hearing a verb used in the passive.⁴⁹

What is notable about the accounts that I have described in this section is that most of them were trying to account for the ACTIONAL/non-ACTIONAL distinction in children's behavior observed by Maratsos et al. (1985). Thus, the explanations are often couched in terms of a dichotomy between children's early success with ACTIONAL verbs and difficulty with non-ACTIONAL verbs. Furthermore, while these accounts attempt to relate children's behavioral pattern with the relative frequency either by verb or lexical semantic feature, there is often little discussion as to how children can eventually learn the passive of non-ACTIONAL verbs from their input. For example, if the low frequency of passives of non-ACTIONAL verbs and the inconsistency of using the preposition *by* as a thematic-role cue impedes children's acquisition (Sudhalter and Braine, 1985), how does successful acquisition occur given children's input?

In light of a finer-grained characterization of children's passive lexical verb asymmetry (beyond ACTIONALITY) which I motivated in the previous chapter, two main questions arise with regards to the relationship between children's linguistic input and their behavior on verbal passives: (i) is there a relationship between the frequency of verbs and children's behavior; and (ii) if not, is there a relationship between the distribution of lexical semantic features in the input and the developmental trajectory that we observe for children's behavior? I provide answers to these two questions by conducting a corpus analysis of English child-directed speech, which I will now turn to in the next section.

⁴⁹Although the results of Pinker et al.'s (1987) study provide evidence for a Verb-by-Verb account, their proposal for children's acquisition seems to favor a mixture of verb- and class-based explanations (e.g., children initially allowing passivization of only AGENT-PATIENT verbs).

3.3 Corpus Analysis of Children’s Linguistic Input

The purpose of this corpus analysis is to characterize the linguistic landscape of children’s learning environment by examining the distribution of verbs used in both the active and passive voice in child-directed speech. I will assess the quantity of input by analyzing both the individual verb frequency as well as the distribution of previously proposed lexical semantic features. Additionally, I will examine the quantity of input by calculating both the type and token frequencies of these verbs and lexical semantic features that are used in the active and passive voice. In doing so, my goal is to evaluate whether there is a relationship between the quality and quantity of input and the lexical verb asymmetry that is observed in children’s behavior for the English verbal passive.

3.3.1 Selected Corpora for Analysis

I examined child-directed speech utterances in the CHILDES Treebank (Version January 2016; MacWhinney, 2000; Pearl and Sprouse, 2013) across two corpora: the Brown corpus (Brown, 1973) (including the Adam, Eve, and Sarah subcorpora) and the Valian corpus (Valian, 1991). This corpus analysis yielded 113,024 child-directed speech utterances directed at children ages 1;06-5;01. Details of the selected corpora can be found in Table 3.1 below.

Table 3.1: Summary of corpora used, including the total number of child-directed speech (CDS) utterances extracted for analysis.

Corpus	File Name in CHILDES Treebank	Number of children	Age range of children	Number of CDS utterances
Brown (1973)	brown-adam.parsed	1	2;3-4;10	26,280
	brown-eve.parsed	1	1;6-2;3	14,246
	brown-sarah.parsed	1	2;3-5;1	46,947
Valian (1991)	valian.parsed	21	1;9-2;8	25,551

The CHILDES Treebank is composed of multiple English corpora where the child-directed speech have been automatically parsed (and additionally hand-checked) for their basic phrase structure trees (Pearl and Sprouse, 2013).⁵⁰

Using the Tregex search tool for pattern matching based on phrase structure trees (Levy and Andrew, 2006), all child-directed utterances that have been marked for the passive were extracted using the “\pass” command. All utterances that were not identified as passives by this command were considered to be utterances in the active voice and were extracted into a separate file. Because these utterances were annotated for their basic phrase structures including the syntactic categories of each word, individual verb tokens from active and passive utterances were extracted using regular expressions. Verbs were lemmatized (or stripped of extraneous morphological inflections), allowing types and tokens to be counted for verbs used in the active and passive utterances.

3.3.2 Frequency of Passives

Of the 113,024 child-direct speech utterances, the procedure for verb extraction across active and passive utterances yielded a total 62,784 verb tokens from 747 verbs with 73% of these verbs being passivizable. For this analysis, I considered a verb passivizable if it (i) has a transitive form and, (ii) can take the passive form, such as *break* (*I broke it/It was broken*). This notably excludes intransitive verbs that can appear in the pseudo-passive like *laugh* (*It was laughed at*).⁵¹ Syntactically speaking, passivizable verbs allow for an active or a passive utterance to describe the same event. But despite the abundant opportunities for using a passive construction given the high frequency of passivizable verbs, only 361 tokens of 119 verbs were actually used in the passive, which accounts for only 0.5% of the

⁵⁰The CHILDES Treebank also includes annotations for trace labels, animacy, and thematic-role relations, though this information was not used for the present analysis.

⁵¹As we will see in Section 3.3.3.2, while these pseudopassives were not included in the calculation of passivizable verbs, they are included in the calculation of verbs that appear in the passive in child-direction speech.

total verb tokens.⁵² This in line with previous research showing passives to be infrequent in child-directed speech (e.g., [Gordon and Chafetz 1990](#), see Section 3.2.2.2).

3.3.3 Examining the Developmental Trajectory of children’s Passives

In the synthesis of experimental studies discussed in Chapter 2, which summarized (i) the verbs used as stimuli and (ii) English-speaking children’s performance on long passives for those verbs at different ages for twelve experimental studies, I determined an “age of acquisition” (AoA) for 30 verbs (i.e., the age when children begin performing significantly above chance) (see Chapter 2 for more details of this synthesis of experimental studies). Table 3.2 details these 30 verbs along with their proposed AoA. Since we have experimental evidence of when children understand these verbs in the long passive, we will evaluate the predictions of our frequency-based hypotheses against the developmental trajectory formed by these 30 verbs.

Table 3.2: AoA of verbs from the synthesis of experimental studies, representing an AoA by 3 years old (3yr), between 3 and 4 years old (3-4yr), between 4 and 5 years old (4-5yr), and 5 years old (5yr).

AoA	Verbs
3yr	<i>carry, drop, eat, hold, hug, kick, kiss, push, shake, wash</i>
3-4yr	<i>annoy, chase, frighten, hit, pat, pull, scare, shock, squash, surprise, upset</i>
4-5yr	<i>find, fix, forget, paint, spot</i>
5yr	<i>hate, like, love, remember</i>

3.3.3.1 Individual Verb Frequency

Looking at the frequency of the 30 verbs in Table 3.2, there were 4143 tokens of 27 verbs in the sample of child-directed speech. Table 3.3 shows the individual verb frequency and the frequency of the passive use of all 30 AoA verbs. Notably, the passive form of these

⁵²There may be additional pragmatic reasons for why adults are more reluctant to use the passive, so the opportunities to use passives felicitously may not be so abundant.

verbs was rarely produced for 12 of these 30 verbs (only 25 passive instances of these 12 verbs total) and 0 instances of the passive for the remaining 18 verbs.

Table 3.3: Individual verb frequencies for the 30 verbs in children’s input that had an observed age of acquisition (AoA), sorted by the frequency of their passive use in children’s input.

AoA	Verb	Adult verb freq	Adult pass freq
4-5	<i>fix</i>	215	6
3	<i>wash</i>	99	3
3-4	<i>squash</i>	6	3
3-4	<i>scare</i>	12	2
5	<i>love</i>	114	2
3	<i>eat</i>	654	2
3	<i>kiss</i>	31	2
3	<i>hug</i>	13	1
3	<i>push</i>	195	1
3-4	<i>hit</i>	198	1
3-4	<i>surprise</i>	11	1
4-5	<i>paint</i>	43	1
3	<i>carry</i>	41	0
3	<i>drop</i>	120	0
3	<i>hold</i>	234	0
3	<i>kick</i>	34	0
3	<i>shake</i>	29	0
3-4	<i>chase</i>	26	0
3-4	<i>pat</i>	4	0
3-4	<i>pull</i>	196	0
3-4	<i>annoy</i>	0	0
3-4	<i>frighten</i>	19	0
3-4	<i>shock</i>	0	0
3-4	<i>upset</i>	0	0
4-5	<i>find</i>	357	0
4-5	<i>forget</i>	67	0
4-5	<i>spot</i>	0	0
5	<i>hate</i>	15	0
5	<i>like</i>	1150	0
5	<i>remember</i>	290	0

Despite the infrequent use of passives in child-directed speech, we can still try to evaluate the predictions of verb-based hypotheses and see whether there is a correlation between the frequency of these verbs and children’s behavior on the passive. Specifically,

we can look to see whether the predictions of the Verb-By-Verb and Overall Verb Frequency accounts are borne out in the data. If either individual verb frequency or passive frequency in the input drive children's AoA for the English verbal passive, we might predict a negative correlation between these frequency factors and AoA such that as the frequency of these verbs (as used in either the active or the passive voice) decreases, it would take children longer to acquire that verb in the verbal passive (and thus a later AoA would be observed).

When we plot AoA on the x-axis and the frequencies of the 30 verbs on the y-axis (see Table 3.3), Figures 3.1 and 3.2 emerge, which compare both passive use frequency and individual verb frequency against observed AoA for the 30 verbs from the synthesis of experimental studies, respectively. As can be readily seen from Table 3.3 and Figures 3.1 and 3.2, there is very little direct relationship between individual verb frequency ($r = 0.29$)⁵³ or individual verb passive frequency ($r = 0.02$) and observed AoA. Moreover, within each AoA group of verbs, there is variation in input frequency for both individual verb use and passive use.

The predictions of the Verb-By-Verb and Overall Verb Frequency accounts are not borne out in these findings. While it is true that these instances of verbs used in the passive are indeed quite infrequent (with six passives of the verb *fix* being the most), the Verb-By-Verb account would still make the prediction that having heard the verb in the passive is strong enough evidence that the verb is passivizable. On the other hand, the Overall Verb Frequency account would predict verbs with earlier AoAs to be highly frequent in the input. However, the lack of correlation between a verb's frequency and its AoA for both passive use and overall suggests that accounts based on individual verb frequency may not explain children's lexical verb asymmetry with the verbal passive.

At the moment, the predictions of frequency-based accounts that count individual verbs are not supported by the current corpus analysis. We can now turn to the Individ-

⁵³Notably, *eat* and *like* are outliers for verb frequency. When we remove these verbs from the analysis, we find even lower correlation ($r = 0.25$).

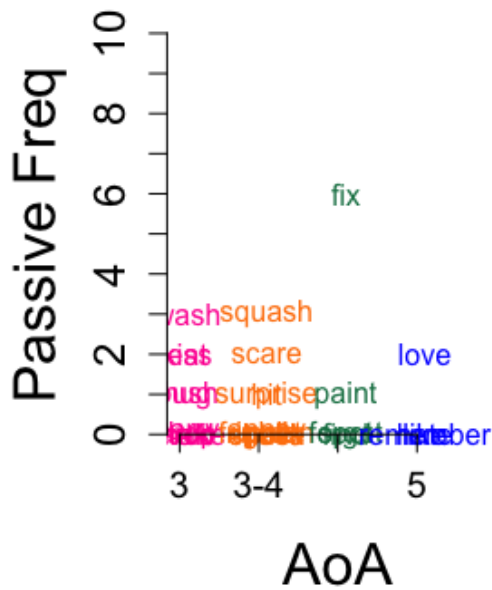

Figure 3.1: Age of acquisition (AoA) by passive use frequency.

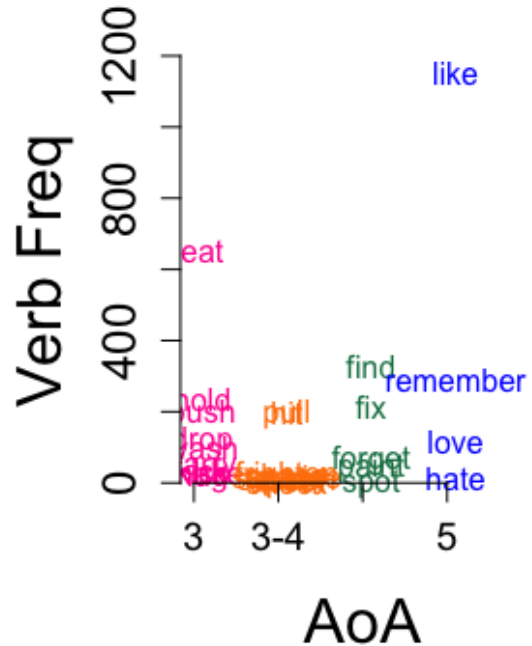

Figure 3.2: Age of acquisition (AoA) by individual verb frequency

ual Lexical Semantic Features account to see whether there is a relationship between the frequency of lexical semantic features and a verb’s AoA.

3.3.3.2 Distribution of Lexical Semantic Features

There are seven lexical semantic features that have been proposed in the literature to potentially affect children’s performance on the verbal passive: ACTIONAL, STATIVE, VOLITIONAL, AFFECTED, and the thematic-role relations (Maratsos et al., 1985; Pinker et al., 1987; Messenger et al., 2012; Liter et al., 2015; Nguyen, 2015). A verb can be defined as (not) having a particular feature according to diagnostic tests or “signals” provided by the researchers who originally proposed this feature as shown in Table 2.4 and discussed extensively in Chapter 2.

According to the Individual Lexical Semantic Features account, the passive lexical verb asymmetry that we observe in children’s behavior can be explained by the frequency of these individual features in the linguistic input (see Section 3.2.2.3). For example, chil-

dren’s difficulty with passives of SUBJECT-EXPERIENCER verbs may be due to not hearing any instances of SUBJECT-EXPERIENCER passives in the input (Maratsos et al., 1985). Thus, in terms of input frequency and a verb’s AoA, the Individual Lexical Semantic Features account would predict a negative correlation such that the more frequently a lexical semantic feature is used in the passive voice, the earlier (i.e. lower in number) the AoA is predicted to be for that verb.

In order to assess the distribution of lexical features in child-directed speech, the verbs that have been extracted from the CHILDES Treebank corpus analysis need to be annotated for their lexical features (e.g., marked for whether they are +ACTIONAL or –ACTIONAL). When these verbs have been associated with a particular lexical semantic “profile” — the collection of lexical features for that verb — we can then calculate the frequency of these lexical features that appear in the active and passive voice in our corpus of child-directed speech.

Addition of TRANSITIVITY. For this analysis, I also annotated verbs for an additional lexical feature, that of TRANSITIVITY, such that a verb is +TRANSITIVE if it selects for an internal argument (i.e., a direct object) like the verb *kick* (e.g., *I kicked the ball*) and –TRANSITIVE if it does not have an internal argument like the verb *laughed* (e.g., *I laughed the ball*). Although this is not a feature that has been proposed to impact children’s acquisition of the verbal passive, being a +TRANSITIVE verb is part of the core definition of the passive in English as it involves the promotion of the internal argument to subject position (Levin, 1993). Thus, TRANSITIVITY is a feature that is implicitly included in all discussions about lexical features and the passive. For example, discussions of the impact of ACTIONALITY on children’s acquisition of the verbal passive can be similarly described as the impact of [ACTIONALITY & TRANSITIVITY]. Because we do not yet know exactly what kind of lexical semantic evidence children are harnessing from their input in order to learn about the verbal passive, it would be useful for us to include TRANSITIVITY

in our annotations of verbs that are produced in child-directed speech. I will return to discussions about the necessity of the TRANSITIVITY feature for children's acquisition in Chapter 5.

Lexical Semantic Feature Annotations. Each verb was annotated for their lexical features according to the signals and example annotations shown in Table 2.4 and 2.7 introduced in Chapter 2. Thus, every verb will have a lexical semantic profile of these annotations. For example, the lexical semantic profile of *fix* will be a collection of eight lexical features [+ACTIONAL, -STATIVE, -VOLITIONAL, -OBJ-EXP, -SUBJ-EXP, +AGT-PAT, +TRANSITIVE]. These annotations were done manually using my native English judgments.

Frequency of Lexical Features. From the corpus analysis of 113,024 child-directed utterances, 62,784 verb tokens of 742 verb types were extracted and subsequently annotated for their lexical semantic profile. Table 3.4 summarizes the frequency of these lexical features used overall as well as in the active and passive voice in children's linguistic input. The annotations of these 742 verb types reveal 36 unique lexical profiles. Of the 361 passive utterances in child-directed speech, there were 116 verb types from 11 unique lexical profiles. See Appendix A.2 for a list of all 742 verb types that were extracted from the corpus analysis of child-directed speech.

Frequency of ACTIONALITY. For the ACTIONALITY feature proposed by Maratsos et al. (1985), the Individual Lexical Semantic Features account would predict that children's early success on +ACTIONAL passives would be correlated with higher frequency counts of +ACTIONAL verbs (like *eat*) used in the passive in the linguistic input. When examining verb tokens, this prediction seems indeed to be borne out. Out of 361 passive tokens, 342 (95%) utterances were used with +ACTIONAL verbs which leaves only 19 (5%) passive utterances used with -ACTIONAL verbs (like *remember*). This high frequency of

Table 3.4: Distribution (in raw counts) of lexical features from child-directed speech, including frequencies of passive, active, and overall use.

Feature	Overall Frequency		Passive Use Frequency		Active Use Frequency	
	Type (out of 742)	Token (out of 62,784)	Type (out of 116)	Token (out of 361)	Type (out of 626)	Token (out of 62,423)
ACTIONAL	668	45,689	109	342	666	45,347
AFFECTED	429	27,161	100	308	431	26,853
STATIVE	66	13,908	8	10	66	13,898
VOLITIONAL	584	46,546	108	342	589	46,204
AGT-PAT	499	32,545	103	332	500	32,213
OBJ-EXP	20	335	6	15	17	320
SUBJ-EXP	32	12,468	3	4	35	12,464
TRANSITIVE	556	49,318	111	349	556	45,347

+ACTIONAL verbs in the passive is also seen in the verb types used in these child-directed utterances. Specifically, of the 116 verb types used in the passive, 109 (94%) verb types were +ACTIONAL verbs and 7 (6%) verb types were –ACTIONAL verbs.

Frequency of AFFECTEDNESS. For the AFFECTEDNESS feature proposed by [Pinker et al. \(1987\)](#), the Individual Lexical Semantic Features account would predict that children’s early success on +AFFECTED passives would be correlated with higher frequency counts of +AFFECTED verbs (like *break*) used in the passive in the linguistic input. When examining verb tokens, this prediction seems indeed to be the case. Out of 361 passive tokens, 308 (85%) utterances were used with +AFFECTED verbs which leaves only 53 (15%) passive utterances used with –AFFECTED verbs (like *spot*). This high frequency of +AFFECTED verbs in the passive is also seen in the verb types used in these child-directed utterances. Specifically, of the 116 verb types used in the passive, 100 (86%) verb types were +AFFECTED verbs and 16 (14%) verb types were –AFFECTED verbs.

Frequency of STATIVITY & VOLITIONALITY. [Liter et al. \(2015\)](#) proposed that children’s behavior on verbal passives is impacted by verbs from a combination of STATIVITY and VOLITIONALITY. Specifically, under the Individual Lexical Semantic Features account,

they would predict that [-STATIVE, +VOLITIONAL] verbs (like *carry*) are more frequent than [-STATIVE, -VOLITIONAL] verbs (like *spot*) and [+STATIVE, -VOLITIONAL] verbs (like *love*) are less frequent than [-STATIVE, -VOLITIONAL] verbs. Out of 361 passive tokens, 335 (93%) utterances were used with [-STATIVE, +VOLITIONAL] verbs and 16 (4%) utterances were used with [-STATIVE, -VOLITIONAL] verbs, which leaves only 3 (0.08%) passive utterances used with [+STATIVE, -VOLITIONAL] verbs. These feature frequency rates can also be seen in the verb types used in these child-directed utterances. Specifically, of the 116 verb types used in the passive, 102 (88%) verb types were [-STATIVE, +VOLITIONAL] verbs, 8 (0.07%) verb types were [-STATIVE, -VOLITIONAL], and 3 (0.03%) verb types were [+STATIVE, -VOLITIONAL] verbs. As mentioned before, [Liter et al. \(2015\)](#) do not make reference to a fourth potential type of verb, that of [+STATIVE, +VOLITIONAL] verbs (like *frighten*). In the corpus sample, child-directed utterances in the passive are composed of 7 (0.02%) verb tokens of 6 (0.05%) verb types.

Frequency of Thematic-Role Relations. [Messenger et al. \(2012\)](#) proposed that children's behavior on verbal passives is impacted by the thematic-role relations of the verbs used such that children are proposed to succeed on passives of +AGENT-PATIENT and +OBJECT-EXPERIENCER verbs before passives of +SUBJECT-EXPERIENCER verbs. The Individual Lexical Semantic Features account would predict that child-directed speech would have a higher frequency of +AGENT-PATIENT and +OBJECT-EXPERIENCER verbs used in the passive than +SUBJECT-EXPERIENCER verbs. Given that [Messenger et al. \(2012\)](#) found comparable performances on passives of +AGENT-PATIENT and +OBJECT-EXPERIENCER verbs in young children, the Individual Lexical Semantic Features account would additionally predict comparable rates of these features used in the passive in the corpus sample. Out of 361 passive tokens, 332 (92%) utterances were used with +AGENT-PATIENT verbs and 15 (4%) utterances were used with +OBJECT-EXPERIENCER verbs, which leaves only 4 (1%) passive utterances used with +SUBJECT-EXPERIENCER verbs. The frequency rates of these features

can also be seen in the verb types used in these child-directed utterances. Specifically, of the 116 verb types used in the passive, 103 (89%) verb types were +AGENT-PATIENT verbs, 6 (5%) verb types were +OBJECT-EXPERIENCER, and 3 (3%) verb types were +SUBJECT-EXPERIENCER verbs.

Frequency of TRANSITIVITY. As previously noted, although no specific proposal has put forth TRANSITIVITY as a lexical feature that is predicted to impact children’s behavior on the verbal passive, it is nonetheless part of the core definition of a passivizable verb (Levin, 1993). When all of the verbs that appear in the passive in child-directed speech were annotated for TRANSITIVITY, 349 (97%) tokens of 111 (96%) verb types were +TRANSITIVE. This suggests that there were 12 (3%) tokens of 5 (4%) verb types that were –TRANSITIVE. But because –TRANSITIVE verbs should not allow for passivization, I checked the passive utterances that contained these –TRANSITIVE verbs. An example utterance for each of the five –TRANSITIVE verb types is shown in (3.2)-(3.6). These utterances do not appear to be verbal passives (as defined in Chapter 2) because either (i) the verbs are unaccusative verbs as in the case of (3.2) and (3.3), (ii) these –TRANSITIVE verbs form a pseudo-passive with the addition of a post-verbal preposition as in (3.4) and (3.5), or (iii) the utterance is ungrammatical as in (3.6).

(3.2) “It must have come from another one.”

(3.3) “No, you were born in Boston.”

(3.4) “... did you get stepped on?”

(3.5) “... that we don’t get run over by cars.”

(3.6) “You’re going to be slipped.”

Interim Discussion. Table 3.5 and Table 3.6 summarize the distribution in percentages of the eight lexical features of interest in the passive utterances in child-directed speech.

Under the Individual Lexical Semantic Features account, the passives that children succeed on the earliest are predicted to be ones with verbs of lexical features that are more frequent in the linguistic input. For example, children succeed on passives of +ACTIONAL verbs because they hear more passives of that type of verb in their input. (This is marked by 94% under the + Feature Value column in Table 3.6.) For each of the proposals that has put forth a lexical feature that could impact children’s behavior, the predictions under this account for children’s early success seem to borne out: +ACTIONAL verbs are indeed more frequent in the passive (Maratsos et al., 1985), but so are +AFFECTED verbs (Pinker et al., 1987), [-STATIVE, +VOLITIONAL] verbs (Liter et al., 2015), and +AGENT-PATIENT verbs (Messenger et al., 2012).

Table 3.5: Distribution (represented as proportions) of lexical features in child-directed passive utterances for verb type (out of 116).

Feature Value	+	—
ACTIONAL	.94	.06
AFFECTED	.86	.14
STATIVE	.07	.093
VOLITIONAL	.93	.07
AGT-PAT	.89	.11
OBJ-EXP	.05	.95
SUBJ-EXP	.03	.97
TRANS	.96	.04

Table 3.6: Distribution (represented as proportions) of lexical features in child-directed passive utterances for verb token (out of 361).

Feature Value	+	—
ACTIONAL	.95	.05
AFFECTED	.85	.15
STATIVE	.03	.97
VOLITIONAL	.95	.05
AGT-PAT	.92	.08
OBJ-EXP	.04	.96
SUBJ-EXP	.01	.99
TRANS	.97	.03

One important finding of this corpus analysis is that while Eventive verbs (broadly

speaking in order to encompass the verbs mentioned previously) are more frequent in the passive in child-directed speech and thus may explain children's earlier success on those verbs in the passive, children's comparably early success on +OBJECT-EXPERIENCER verbs, as observed by [Messenger et al. \(2012\)](#), cannot be accounted for by the corpus analysis. Passive utterances of +OBJECT-EXPERIENCER verbs are similarly as infrequent in the linguistic input as passives of +SUBJECT-EXPERIENCER verbs. The low frequency of these two types of verbs would be predicted by the Individual Lexical Semantic Features account to mean that children should have difficulty with passives of these verbs. While this is the case for +SUBJECT-EXPERIENCER verbs, [Messenger et al. \(2012\)](#) found early success for +OBJECT-EXPERIENCER verbs in young children.

So far in this section, I have treated these eight lexical features as relatively independent from each other (with the exception of STATIVITY and VOLITIONALITY) in order to assess the predictions of the separate proposals from previous literature. In the next section, I will examine whether there is a relationship between children's behavior on the verbal passive and the frequency of combinations (which I refer to as a verb's "profile") of these lexical features.

3.3.3.3 Frequency of Derived Lexical Semantic Profiles

Five Lexical Semantic Profiles. As observed from the synthesis of experimental studies discussed in Chapter 2, the lexical features of the 30 verbs that have an AoA for the passive (Table 3.2) form five distinct lexical semantic profiles. As discussed in Chapter 2, these five profiles span across the four different AoAs observed from the synthesis of experimental studies of children's performance on the verbal passive and are named after the order in which these profiles were identified. There is some predictive power in the labels in that the lexical semantic profile hypothesis would predict profiles with a smaller number to be acquired earlier than profiles would a higher number. So when comparing Profiles 1 and 3, we would predict Profile 1 to be earlier, likewise would not predict Profile 3 to be

earlier. Table 2.10, which shows these five lexical semantic profiles, is repeated below as Table 3.7.

Table 3.7: Lexical semantic profiles comprised of the seven lexical semantic features for example verbs with different experimentally observed ages of acquisition (AoA).

Profile	AoA						
	3yrs	3-4yrs		4-5yrs			5yrs
	<i>carry</i>	<i>chase</i>	<i>annoy</i>	<i>fix</i>	<i>find</i>	<i>forget</i>	<i>hate</i>
	1	1	2	1	3	4	5
ACTIONAL	1	1	0	1	1	0	0
STATIVE	0	0	1	0	0	0	1
VOLITIONAL	1	1	1	1	0	0	0
AFFECTED	1	1	1	1	0	0	0
OBJ-EXP	0	0	1	0	0	0	0
SUBJ-EXP	0	0	0	0	0	1	1
AGT-PAT	1	1	0	1	1	0	0

Frequency of Profiles in Child-Directed Speech. Because these five lexical semantic profiles are ordered in Table 3.7 according to their AoA, we can examine whether there is a relationship between the frequency of these lexical profiles in the linguistic input and their AoA. I will refer to this hypothesis as the "Frequency of Lexical Profiles" account. In particular, the Frequency of Lexical Profiles account would predict that Profiles that have earlier AoAs would be more frequent in child-directed speech than Profiles that have later AoAs. Out of 361 passive tokens, 287 (80%) utterances were used with Profile 1 verbs, 6 (2%) utterances were used with Profile 2 verbs, and 3 (0.08%) passive utterances used with Profile 5 verbs. The frequency rates of these profiles can also be seen in the verb types used in these child-directed utterances. Specifically, of the 116 verb types used in the passive, 89 (77%) verb types were Profile 1 verbs, 5 (4%) verb types were from Profile 2, and 2 (2%) verb types were Profile 5 verbs. There were no instances where Profile 3 and Profile 4 verbs were used in the passive.

It seems to be the case that the passive utterances produced by adult caregivers are heavily skewed towards Profile 1 verbs. As verbs from this profile have the earliest re-

Table 3.8: Distribution (in raw counts) of lexical semantic profiles from child-directed speech, including frequencies of overall, passive, and active use.

Profile	Overall Frequency		Passive Use Frequency		Active Use Frequency	
	Type (out of 742)	Token (out of 62,784)	Type (out of 116)	Token (out of 361)	Type (out of 626)	Token (out of 62,423)
1	393	26,076	89	287	388	25,781
2	10	72	5	6	9	66
3	18	769	0	0	18	769
4	9	2,841	0	0	9	2,841
5	20	9,284	2	3	20	9,281

ported AoA (3yr), the high frequency of passives from this Profile 1 is in line with the predictions of the Frequency of Lexical Profiles account. But again, passives of Profile 2 verbs have been found to be comparably easy for young children (with an AoA of 3-4 years) as compared to passives of Profile 5 verbs (with an AoA of 5 years) (Messinger et al., 2012). And yet, the frequency rates of these two profiles are almost equally rare in the linguistic input. A Lexical Semantics account which proposes a direct relationship between input and children’s behavior would predict Profile 2 to be difficult for young children given its low frequency rates, which is not the case here.

Table 3.9: Distribution (represented as proportions) of lexical semantic profiles in child-directed passive utterances for verb type (out of 116) including earliest reported age of acquisition (AoA).

Profile	AoA	Percentage
1	3yr	.78
2	3-4yr	.04
3	4-5yr	.0
4	4-5yr	.0
5	5yr	.02

3.3.3.4 Frequency Over Time

The corpus analysis so far is aggregated over all utterances from an age range of 1;06-5;01. I have found that child-directed passive use is heavily skewed towards the passives of verbs which children are predicted to acquire earliest. However, the current analysis

Table 3.10: Distribution (represented as proportions) of lexical semantic profiles in child-directed passive utterances for verb token (out of 361) including earliest reported age of acquisition (AoA).

Profile	AoA	Percentage
1	3yr	.80
2	3-4yr	.02
3	4-5yr	.0
4	4-5yr	.0
5	5yr	.008

cannot explain why young children may have more difficulty with passives of some verbs over others when the frequency rates are comparably low in the linguistic input, as is the case for verbs like *frighten* and *love*. But because we are investigating whether the linguistic input can predict the developmental trajectory that is observed for children’s behavior, it is worth examining whether there is a qualitative difference in children’s linguistic input over time such that children are exposed to passives of certain types of verbs at different developmental periods.

One prediction may be that although +OBJECT-EXPERIENCER and +SUBJECT-EXPERIENCER verbs are similarly infrequent in the input, there is a higher rate of +OBJECT-EXPERIENCER verbs early on in children’s development which serves as “enough” evidence for children to be able to succeed on passives of those verbs as opposed to +SUBJECT-EXPERIENCER verbs, which children may not encounter in the passive until later on in development in their input. In order to investigate such predictions, the corpus analysis needs to be divided up into sub-corpora based on the developmental ages of the children.

We can divide the child-directed speech into three sub-corpora based on the age range of the children: (1) a current corpus which contains speech directed at children 1;06-5;01, which I will refer to as “up to 5yr”; (2) a corpus of speech directed at children 1;06-4;00 (“up to 4yr”); (3) a corpus of speech directed at children 1;06-3;00 (“up to 3yr”). The corpus that is up to 3yr is a proper subset of the utterances contained in the corpus that is up to 4yr which is in turn a proper subset of the corpus that is up to 5yr. Table 3.11 -

Table 3.16 summarizes the distribution of the eight lexical features that appear in passive utterances in child-directed speech for verb types and tokens for speech up to 5yr (Table 3.11 - Table 3.12, which is a repetition of Table 3.5 and Table 3.6), up to 4yr (3.13 - Table 3.14), and up to 3yr (3.15 - Table 3.16).

The distribution of lexical features that is observed for all child-directed passive utterances in the corpus that is up to 5yr (Table 3.11 - Table 3.12) is stable across speech to younger children (Table 3.13 - Table 3.16) for both verb types and tokens. Taking the distribution of the lexical features based on thematic-role relations as an example, we see that passive utterances directed at children are heavily skewed towards +AGENT-PATIENT verbs (above 80%) while +OBJECT-EXPERIENCER and +SUBJECT-EXPERIENCER verbs remain similarly infrequent in the passive (around 5% or less). There is little fluctuation in these featural distributions in the linguistic input across development.

Table 3.11: Distribution (represented as proportions) of lexical features in child-directed passive utterances for verb type (out of 116).

Feature Value	+	—
ACTIONAL	.94	.06
AFFECTED	.86	.14
STATIVE	.07	.93
VOLITIONAL	.93	.07
AGT-PAT	.89	.11
OBJ-EXP	.05	.95
SUBJ-EXP	.03	.97
TRANS	.96	.04

3.4 Discussion

In a corpus analysis of English child-directed speech to children, I examined verbs that were produced in the active and passive voice. Under a hypothesis that there is a direct relationship, or more specifically a negative correlation, between passive utterances in child-directed speech and the lexical verb asymmetry observed in children’s behavior, I found that children’s early success on passives of some verbs (e.g., +ACTIONAL verbs)

Table 3.12: Distribution (represented as proportions) of lexical features in child-directed passive utterances for verb token (out of 361).

Feature Value	+	—
ACTIONAL	.95	.05
AFFECTED	.85	.15
STATIVE	.03	.97
VOLITIONAL	.95	.05
AGT-PAT	.92	.08
OBJ-EXP	.04	.96
SUBJ-EXP	.01	.99
TRANS	.97	.03

Table 3.13: Distribution (represented as proportions) of lexical features in child-directed passive utterances for verb type up to 4yr.

Feature Value	+	—
ACTIONAL	.83	.17
AFFECTED	.85	.15
STATIVE	.07	.93
VOLITIONAL	.90	.10
AGT-PAT	.83	.17
OBJ-EXP	.06	.94
SUBJ-EXP	.05	.95
TRANS	.96	.04

Table 3.14: Distribution (represented as proportions) of lexical features in child-directed passive utterances for verb token up to 4yr.

Feature Value	+	—
ACTIONAL	.91	.09
AFFECTED	.92	.08
STATIVE	.03	.97
VOLITIONAL	.96	.04
AGT-PAT	.91	.09
OBJ-EXP	.04	.96
SUBJ-EXP	.02	.98
TRANS	.99	.01

could be explained by a higher frequency of the passive use of those verbs. This suggests that children are utilizing their linguistic input to learn that these verbs allow passivization in English. One major finding of this corpus analysis is that input frequency was only relevant when the corpus was examined through the lens of lexical features

Table 3.15: Distribution (represented as proportions) of lexical features in child-directed passive utterances for verb type up to 3yr.

Feature Value	+	—
ACTIONAL	.78	.22
AFFECTED	.87	.13
STATIVE	.10	.90
VOLITIONAL	.89	.11
AGT-PAT	.82	.18
OBJ-EXP	.09	.91
SUBJ-EXP	.04	.96
TRANS	.97	.03

Table 3.16: Distribution (represented as proportions) of lexical features in child-directed passive utterances for verb token up to 3yr.

Feature Value	+	—
ACTIONAL	.88	.12
AFFECTED	.94	.06
STATIVE	.06	.94
VOLITIONAL	.96	.04
AGT-PAT	.89	.11
OBJ-EXP	.07	.93
SUBJ-EXP	.02	.98
TRANS	.99	.01

rather than the individual verbs themselves. This suggests that the quality of evidence that may be useful for children’s acquisition of the passive is the distribution of lexical features in the input rather than individual verbs or the overall frequency of passive utterances. However, children’s early success on passives of +OBJECT-EXPERIENCER verbs cannot be accounted for by the input frequency of this (or any other) lexical feature; passives of +OBJECT-EXPERIENCER verbs are similarly as infrequent as passives of +SUBJECT-EXPERIENCER verbs which are delayed in children.

Another major finding of this investigation is that the linguistic input to children is stable and relatively consistent over time especially with regards to the low frequency between passives of certain verbs (e.g., +OBJECT-EXPERIENCER verbs) that have been shown to be acquired early in children. If it is the case that children do indeed have the knowl-

edge of these verbs in the passive early, low input frequency of these verbs would suggest that children are not dependent on their linguistic input to learn that these verbs do allow passivization. To reconcile these findings of children seemingly utilizing their linguistic input in unequal ways, I propose that there are developmental changes to how children are harnessing their input for successful language acquisition. In other words, rather than making use of all of the evidence for passives available to them in the linguistic input, children may be only utilizing a subset of the input, i.e., their intake, and this intake of the input may vary developmentally. We can refer to this sub-setting of the input that is actually harnessed by children as the intake. So, while the quantity and quality of the evidence can remain the same for children's input, the actual evidence that children are making use of changes depending on children's intake.

At present, we have a good idea of what the input looks like for children in terms of the quality and quantity of verbs used in the passive and active voice, but there still remains a question of what children's intake looks like. As mentioned in Section 3.1.2, it does not quite matter how much children are exposed to the passive in their input; if they are unable (for whatever reason) to harness this information, they are effectively in an impoverished learning environment and must rely on different means to succeed at the learning task. In Chapter 5, I will further discuss how differences in English-speaking children's intake of the child-directed speech can change over time and may result in differences in children's development of the verbal passive.

Gordon and Chafetz (1990) provide a discussion on experimental ways in which we may test hypotheses of the impact that the quality and quantity of input may have on children's acquisition. Either we can overwhelm or "saturate" children with a certain kind of input or we can limit or "deprive" children of a certain kind of input. In particular, for cases of saturation, we can test whether young children can succeed on passives of -ACTIONAL verbs early if they are exposed to more linguistic input of passives of that type. Indeed De Villiers (1984) reported comparable performance between pas-

sives of +ACTIONAL and –ACTIONAL verbs when young children were trained on (in this case, asked to repeat) passives of –ACTIONAL verbs. Furthermore, in a novel-verb learning study, [Pinker et al. \(1987\)](#) found children to be just as willing to passivize –ACTIONAL verbs when these nonce verbs were taught to them in the passive voice. These results suggest certain aspects of the linguistic input can play a key role in children’s behavior with regards to the verbal passive. For cases of deprivation, we can test whether children allow passivization of nonce verbs that have only been taught to them in the active voice. The ability to tightly control the input that is provided to children allows us to test whether children need positive evidence of a verb used in the passive when learning the verbal passive. I will return to the discussion in [Chapter 6](#) regarding what we can learn from the deprivation of linguistic input in this sense when I discuss the novel-verb learning study that I conducted.

3.5 Summary

In this chapter, I characterized children’s learning environment by assessing the quality and quantity of linguistic input that is available to English-speaking children. I found that only some parts of the passive lexical verb asymmetry can be explained by the input frequency of passives but only through the lens of lexical semantic features. Furthermore, I found that children’s input of the passive is relatively consistent over time, which suggests that the trajectory observed in children’s behavior may be a result of developmental changes in children’s intake rather than external changes in children’s input. For now, I will set aside how children might harness (particularly low) input frequency in order to exhibit the developmental trajectory that we observe in children’s behavior until [Chapter 5](#) when I discuss potential learnability theories of children’s language acquisition. In the next chapter, I will instead turn my attention to assessing the passive lexical verb asymmetry and what children’s observable behavior can tell us about their knowledge of the passive. I will discuss potential gaps in the developmental trajectory that was derived

from the synthesis of experimental studies as well as discuss a Truth Value Judgment Task that I conducted to fill in those data gaps.

4 | Characterizing Children's Linguistic Behavior⁵⁴

4.1 Introduction

For the acquisition of the verbal *be*-passive in English, children are concerned with two potential learning problems: (i) what is the structural representation of the passive, and (ii) which verbs do (not) allow passivization with the verbal *be*-passive? Because the syntax of the passive as well as the set of verbs that allow passivization are both subject to cross-linguistic variation, it is conceivable that the development of adult-like knowledge in these two domains does not occur simultaneously. For example, children could acquire knowledge of the *be*-passive structure before they figure out which verbs (or verb classes) allow this structure. However, most studies of children's acquisition of the passive have been concerned with investigating children's structural representation of this construction and often appeal to the syntax of the passive in Child English in order to explain non-adult-like behavior observed in children. In other words, delays observed in children's linguistic behavior are often viewed as consequences of an immature structural representation of the verbal passive rather than uncertainty about which verbs allow that structure.

One particular non-adult-like behavior of interest to researchers is English-speaking children's (un-)successful performance on the verbal passive, which seems to be impacted by the lexical semantics of the verb ([Maratsos et al., 1985](#); [Messenger et al., 2012](#); [Liter](#)

⁵⁴The behavioral study described in this chapter has been presented at the following workshops and conferences: BUCLD44 and Linguistic Society of America Annual Meeting (LSA Annual Meeting 2020). Parts of this chapter are based on [Nguyen and Pearl \(2021\)](#). Many thanks to Nicolaus Schrum for lending his voice as Max Rebo, the silly puppet.

et al., 2015; Nguyen, 2015), as discussed earlier. For example, Maratsos et al. (1985) observed that younger children perform better on passives with ACTIONAL verbs like *hug* (4.1) compared to non-ACTIONAL verbs like *love* (4.2). This lexical-feature-based difference in children’s performance on passives is referred to in this dissertation as a lexical verb asymmetry in children’s development of the English verbal passive.

(4.1) Tom was hugged by Lucy.

(4.2) Tom was loved by Lucy.

Theoretical proposals for why children exhibit this lexical verb asymmetry for the passive are usually focused on children’s immature knowledge of the passive structure itself and have ranged from children’s inability to form A-chain dependencies (Borer and Wexler, 1987) to their inability to smuggle the internal argument to the subject position (Snyder and Hyams, 2015) (see Chapter 2 for a more detailed discussion of these and other proposals for children’s acquisition of the verbal passive). These explanations are often couched in terms of a dichotomy between children’s early success with certain verbs and difficulty with other verbs (e.g., the +/-ACTIONALITY distinction). However, as shown in Chapter 2, children’s linguistic behavior on the verbal passive can be characterized as a particular ordering of different classes of verbs based on a combination of lexical features (i.e., profiles) that have been proposed in the literature. I refer to this order of acquisition as the LEXICAL SEMANTIC PROFILE HYPOTHESIS.

Under an assumption that the acquisition of the syntax of the passive and the acquisition of verbs that allow passivization are separate learning problems that do not have to occur simultaneously, this dissertation examines whether the lexical verb asymmetry observed in children is due to an incomplete acquisition of the set of passivizable verbs rather than an immature structural representation of the verbal passive. We can probe children’s knowledge in this domain by examining children’s observable linguistic be-

havior particularly in experimental settings. In this chapter, I will test the predictions of the LEXICAL SEMANTIC PROFILE HYPOTHESIS by examining the lexical verb asymmetry within the same group of English-speaking children in a Truth Value Judgment Task.

4.1.1 Lexical Semantic Profile Hypothesis

Recall from Chapter 2 that there is a correlation between the lexical semantic profile of verbs and the age of acquisition (AoA) for their passive use by English-speaking children. That is, when verbs were sorted based on observed AoA (i.e., the age of significantly above-chance performance from the synthesis of experimental studies), there was a striking relationship between the lexical semantic profile of a verb and that verb's observed AoA (see Table 2.10 repeated below as Table 4.1). In particular, for the 30 verbs that were extracted from a synthesis of experimental studies of 12 experimental studies of English-speaking children's comprehension of the verbal passive, I observed five lexical semantic profiles composed of different combinations of seven lexical semantic features that were derived from the previous literature.⁵⁵ These profiles suggest a natural developmental trajectory for the lexical semantic cues that influence children's ability to interpret long verbal passives.⁵⁶

The LEXICAL SEMANTIC PROFILE HYPOTHESIS proposes that these five lexical semantic profiles correspond to five classes of verbs and the developmental trajectory — or, the order of these profiles according to their observed AoAs — that we see involves children comprehending successively larger subsets of these five classes (such that three-year-olds understand the first profile and five-year-olds understand all five). This hypothesis would predict that children would succeed on the verbs that belong to a particular profile by the

⁵⁵The numerical labels have some predictive power according to the Lexical Semantic Profile Hypothesis such that the profiles with a smaller number should be acquired earlier than profiles with a higher number. So when comparing Profiles 1 and 2, we would predict Profile 1 to be earlier or at the same time as Profile 2 but we would not predict Profile 1 to be later than Profile 2.

⁵⁶Recall that the ages associated with the predicted developmental trajectory are derived from the synthesis of experimental studies of English-speaking children's performance discussed in Chapter 2; for our purposes, these ages serve simply to indicate the relative order that profiles should emerge in.

Table 4.1: Lexical semantic profiles comprised of the seven lexical features for example verbs with different experimentally observed ages of acquisition (AoA).

Profile	AoA						
	3yrs	3-4yrs		4-5yrs			5yrs
	<i>carry</i>	<i>chase</i>	<i>annoy</i>	<i>fix</i>	<i>find</i>	<i>forget</i>	<i>hate</i>
	1	1	2	1	3	4	5
ACTIONAL	1	1	0	1	1	0	0
STATIVE	0	0	1	0	0	0	1
VOLITIONAL	1	1	1	1	0	0	0
AFFECTED	1	1	1	1	0	0	0
OBJ-EXP	0	0	1	0	0	0	0
SUBJ-EXP	0	0	0	0	0	1	1
AGT-PAT	1	1	0	1	1	0	0

earliest observed AoA for that profile. Discrepancies between the lexical semantic profiles for some verbs and the observed AoA (e.g., Profile 1 verb *fix* with an observed AoA of 4-5yrs) are due to gaps regarding the age of the children tested experimentally for those verbs. Thus, if long verbal passives with *fix* were tested with three-year-old children, the LEXICAL SEMANTIC PROFILE HYPOTHESIS would predict above-chance performance. This is one of the stimuli I explicitly test in the experimental task with younger English-speaking children described in this chapter. The predicted developmental trajectory corresponding to English-speaking children’s ages is shown in Table 2.12 repeated as Table 4.2 below.

Table 4.2: AoA predictions (Predicted AoA) for example verbs in English, based on their lexical semantic profiles (Profile).

Profile	Example verbs	Predicted AoA
1	<i>bump, crash, fix, chase, hug</i>	3yrs
2	<i>flatter, hurt</i>	3-4yrs
3	<i>search, discover</i>	4-5yrs
4	<i>spot, notice, overhear</i>	4-5yrs
5	<i>believe, miss, know, remember</i>	5yrs

4.1.2 Gaps in the Empirical Coverage and the Limitations of Current Empirical Data

As previously stated, the developmental trajectory of children's behavior on the verbal passive of different verb classes is derived from a synthesis of experimental studies of verbs that have previously been tested on English-speaking children. But gaps in the empirical coverage of this synthesis of experimental studies make it difficult to assess the validity of the LEXICAL SEMANTIC PROFILE HYPOTHESIS. First, while some experimental studies tested three- and five-year-old children as their own age groups, the age overlap in other studies means that four-year-old children were often grouped in with these other ages. Because of this, we do not know exactly how four-year-olds will perform; four-year-olds could pattern with either the three- or five-year-olds or have a distinct performance pattern with respect to these lexical semantic profiles. Second, only one study in synthesis of experimental studies, [Messenger et al. \(2012\)](#), has tested +OBJ-EXP verbs in young children and found that they could successfully interpret these verb types in the long verbal passive. However, this study was a picture-selection task where pictorial portrayals of stative verbs like *annoy* may have yielded accidental eventive interpretations – so, these accidental eventive interpretations could have led to young children's successful passive interpretations. Because of this possibility, it is unclear if the age of acquisition of the long verbal *be*-passive for Profile 2 verbs like *annoy* is in fact by four years old. Third, Profile 1 verbs (e.g., *fix*) have multiple observed AoAs (e.g., 3, 3-4, and 4-5) but are predicted to be acquired earlier if tested with younger children. Fourth, the synthesis of experimental studies combines the results from different groups of children across multiple age ranges using different experimental stimuli and methods (see Table 2.5 in Chapter 2 for the different methods). So, the differences in methodologies could impact the observed AoAs, and thus the observed developmental trajectory. In particular, more demanding tasks like act-out tasks or elicitation tasks could be masking younger children's knowledge of the verbs tested in the verbal passive. More generally, the LEXICAL SEMANTIC PROFILE HYPOTHESIS would be strengthened if the same group of children performed as this hypothesis

predicts across a variety of verbs with different lexical semantic profiles. I will address all of these limitations in the next section with a behavioral assessment using a Truth-Value Judgment Task. The results from such an experiment will increase the empirical foundation provided by the synthesis of experimental studies, and include four-year-old English comprehension behavior of a variety of verbs from different profiles.

4.2 Experiment

I aim to assess if English-speaking four-year-old children perform as predicted by the lexical profile hypothesis when interpreting the verbal passive. More specifically, this hypothesis predicts that if children are acquiring the passive form of verbs based on specific lexical profiles, then four-year-olds should successfully comprehend particular verbs with certain lexical profiles better than verbs with different lexical profiles. For instance, on the basis of the results of the synthesis of experimental studies connecting age to the comprehension of particular profiles, four-year-olds are expected to successfully comprehend the passive of Profile 1 verbs like *fix*, and possibly Profile 2, 3, and 4 verbs like *surprise*, *find*, and *forget*. Four-year-old children are not expected to comprehend the passive of Profile 5 verbs like *love*.

4.2.1 Participants

I tested 23 children (3;11-5;01, mean age=4;07) recruited from Connecticut daycares, the Connecticut Science Center, and families from the UConn KIDS database. In order to be included in the data analysis, the child had to correctly answer at least four out of the five active control items (i.e., scoring at least 80% correct), and not exhibit a bias towards a particular answer (i.e., a child who gave the same answer to 90% or more of the test items). Given this inclusion criterion, four children were excluded from the final data analysis.⁵⁷

⁵⁷Three children were excluded because they exhibited a yes-/no-bias, and one child was excluded for answering only one of the five active controls correctly.

I report results on the data collected from the remaining 19 children, who had the same age range and mean age as the larger group (3;11-5;01, mean age=4;07).⁵⁸

Experimental sessions were limited to 20 minutes per child (the average length of the current study) across all recruitment sites. With respect to particular recruitment sites, multiple testing visits with the same child were available at some locations (e.g., local daycares); other recruitment sites such as the Connecticut Science Center only permitted a single testing session. If multiple testing visits were available to a child, that child received a training session (as described in the next section) prior to the testing session; this training session familiarized her with the task methodology, including opportunities for corrective feedback. Otherwise, the child was given verbal instructions for the procedure before proceeding to the test items, without any opportunity for corrective feedback. 11 of the 19 children who passed the control criterion received a training session.⁵⁹

As adult controls, ten undergraduate students were recruited from the University of Connecticut Department of Linguistics Participant Pool. All participants were native speakers of US English.

4.2.2 Procedure

A modified version of the Truth-Value Judgment Task (Crain and McKee, 1985; Crain and Thornton, 1998, 2000) was used to investigate the predictions of the LEXICAL SEMANTIC PROFILE HYPOTHESIS. The TVJ task was carried out by a single experimenter using a laptop computer. Stories were narrated by the experimenter using animated clipart displayed in Microsoft PowerPoint. Participants were told that a puppet would also watch the stories with them and, at the end of each story, describe something that had happened in the story. Participants were then asked to determine whether the puppet's statement was "right" or "silly". The procedure was the same for the training session, but corrective

⁵⁸Of these 19 children, four children answered four of the five active controls correctly while the remaining 15 children answered all five active controls correctly.

⁵⁹There was no statistical difference in performance between children who received training and those who did not – see Section 4.2.4 for more discussion.

feedback was provided after every item.

For each participant, follow-up justifications were elicited for the first two to three items in order to ascertain the reason for providing “right” or “silly” responses. If participants seemed willing, follow-up justifications were elicited for the rest of the experimental items. Positive feedback was given to participants after every response in order to avoid accidental cues to incorrect answers. All subjects were tested individually.

4.2.3 Materials

Ten verbs were chosen for testing, two from each of the five lexical profiles identified in the synthesis of experimental studies (see Table 4.3); the stories used in this experiment were created from these 10 verbs (see Appendix A.3).

Wash (Profile 1) and *love* (Profile 5) were chosen because they are frequently attested to be successfully understood in the verbal passive by both younger children (*wash*) and older children (*love*) respectively (Gordon and Chafetz, 1990; Hirsch and Wexler, 2006; Liter et al., 2015; Orfitelli, 2012). These verbs serve as benchmarks for aligning the experimental results found here with the other studies in synthesis of experimental studies. *Fix* (Profile 1) was chosen because the LEXICAL SEMANTIC PROFILE HYPOTHESIS predicts an earlier AoA than the age found by Liter et al. (2015). In particular, Profile 1 verbs are predicted to have an AoA by three in English, so four-year-olds should understand *fix* in the long verbal *be*-passive. *Surprise* (Profile 2), *frighten* (Profile 2), *find* (Profile 3), *spot* (Profile 4), and *forget* (Profile 4) were chosen because they have only been tested in one study each (i.e., in Messenger et al. (2012) for *surprise* and *frighten*, Liter et al. (2015) for *find*, *spot*, and *forget*); so, it is unclear how the same group of children will perform on all these verbs. *Discover* (Profile 3) and *believe* (Profile 5) have never been tested before in children, according to the synthesis of experimental studies on children’s behavioral performance on verbal passives (see Chapter 2), and were included to extend on the previous empirical range.

Table 4.3: Lexical profiles of the 10 verbs tested and the two lists that these verbs were split into, along with their predicted age of acquisition (Predicted AoA) in English, according to the LEXICAL SEMANTIC PROFILE HYPOTHESIS.

	<i>List A:</i>	<i>wash</i>	<i>surprise</i>	<i>discover</i>	<i>spot</i>	<i>love</i>
	<i>List B:</i>	<i>fix</i>	<i>frighten</i>	<i>find</i>	<i>forget</i>	<i>believe</i>
Profile		1	2	3	4	5
ACTIONAL		1	0	1	0	0
STATIVE		0	1	0	0	1
VOLITIONAL		1	1	0	0	0
AFFECTED		1	1	0	0	0
OBJ-EXP		0	1	0	0	0
SUBJ-EXP		0	0	0	1	1
AGT-PAT		1	0	1	0	0
Predicted AoA		3yrs	3-4yrs	4-5yrs	4-5yrs	5yrs

For each of the 10 verbs, three stories were created: two passive stories, and one active story as control. This yielded 30 stories total. Within each verb, the stories were similar to each other, but differed depending on whether participants were told a passive sentence or an active sentence that either matched or did not match the story as the test utterance. Mismatched test sentences were created by switching the ordering of the animate participants (and thus their thematic roles). Test sentences were presented to participants through pre-recorded audio clips spoken by a male native speaker of English. The 30 stories that were used in the experiment can be found in the [Appendix A.3](#) and the accompanying Powerpoint presentations of the stories can be found at [emmanguyenling.github.io](https://github.com/emmanguyenling).

Sample stories for the verbs *frighten* (passive test sentence, mismatch for story) and *love* (passive test sentence, match for story) are shown below:

Sample Story 1 - *frighten*, Profile 2, Mismatch

Narrator: Owen and Jackie are at a costume party. Ladybugs frighten Owen but Jackie loves ladybugs and that's why she's dressed as one for the party.

Jackie: Owen, do you see my ladybug costume? Do I frighten you?

Owen [*frowning*]: Yes, Jackie, you frighten me. You know that I don't like ladybugs!

Test Sentence: Jackie was frightened by Owen. (False)

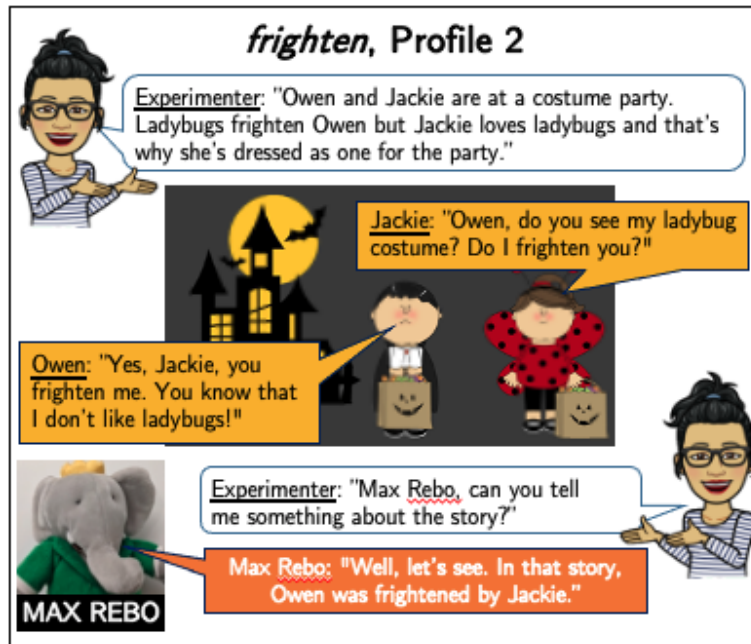

Sample Story 2 - *love*, Profile 5, Match

Narrator: Jake and Isabelle are neighbors. They play with each other every day.

Isabelle: Jake, I don't love you because I'm jealous of your new clothes.

Jake: But I love you because you're my only friend, Isabelle!

Test Sentence: Isabelle was loved by Jake. (True)

The stories were also constructed such that any reliance on linear word order for interpretation would always lead to an incorrect response. For example, in the Sample Story 2 above, a child could interpret the passive test sentence *Isabelle was loved by Jake* by selecting the active response (i.e., *Isabelle loved Jake*) if they were relying on only the linear word order (either due to confusion or lack of structural knowledge of the passive); the child would then provide an incorrect response to the test sentence (False in Sample Story

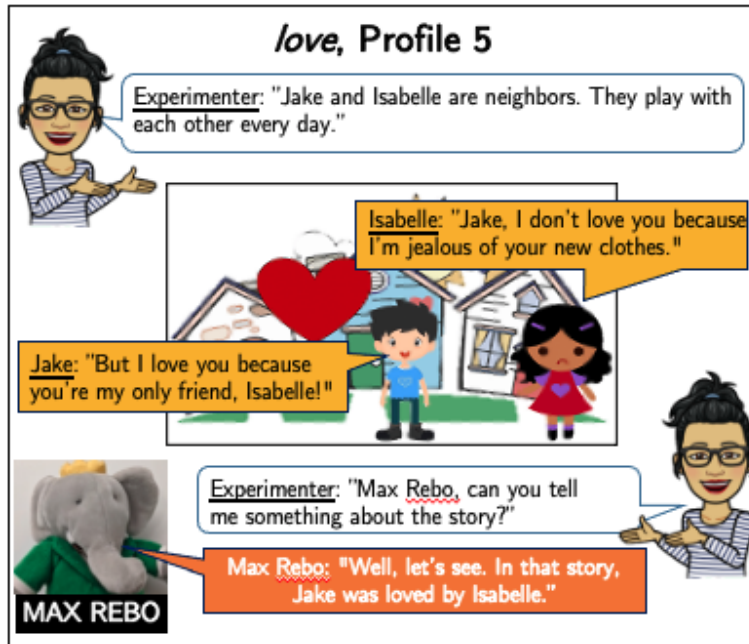

2). Consistently relying on a linear-word-order strategy like that would result in the child systematically providing incorrect responses. For the verbs that fell under Profiles 2 and 5, we kept movement of the characters on-screen to a minimum within the test materials so that participants had to rely on the dialogue of the stories in order to fully comprehend the contexts. This was done to keep +STATIVE verbs as stative as possible and, particularly for Profile 2 verbs, to avoid accidental eventive interpretations.

The 10 verbs and their corresponding stories were split into two lists as shown in Table 4.3. Adult participants were presented with both lists and thus saw all 30 stories. Child participants, on the other hand, were presented with one of the two lists. So, each child participant was tested on a total of 15 stories: three stories (two passives and one active) for each of the five verbs in the list. Children who were tested in a single session, and thus did not receive a training session, were presented with List A verbs; children who did receive a training session were presented with List B verbs. The materials for the training session were drawn from the active control items from List A since these children would always be presented with List B verbs during the experimental session.

Figure 4.1: Percentage of correct responses by verb profile for adult controls. (Error bars indicate standard error.)

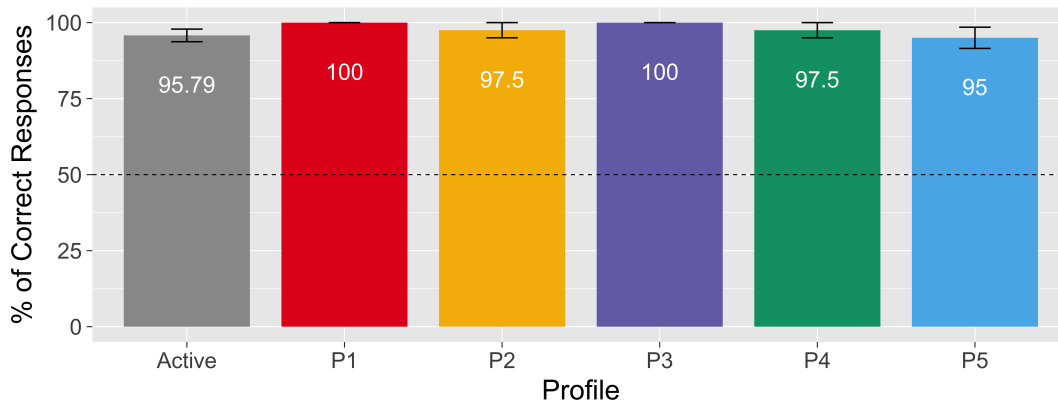

4.2.4 Results and discussion

The performance of child participants who received a training session did not statistically differ from those who did not receive a training session ($t(11.24) = -0.01, p = 0.9$, independent-samples t -test) and thus the data will be collapsed across the two groups for further analysis. Figures 4.1 and 4.2 show the percentage of correct responses by adults and four-year-old children, respectively. Table 4.4 shows the results of participants' comprehension as compared to chance performance (single-sample t -tests) for each verb profile for the adults and the four-year-olds. To see whether the responses were consistent within each child participant, Figure 4.3 shows the distribution of responses broken down by the five lexical profiles (Profile 1-5). So for example, for Profile 1 (P1) in Figure 4.3, of the 19 children, 68% of the children answered all of the test items correctly, 26% of the children were correct 50% of the time, and 5% of the children answered none of the test items correctly. Since participants received two passive test items per condition, this means that 13 children answered both Profile 1 test items correctly, five children only answered one test item correctly, and one child answered neither test items correctly.

For the adult participants, all 10 performed effectively at ceiling and were significantly above chance across all five lexical profiles. This provides evidence that the test materials elicited the correct answers from adults and that the baseline for adult-like knowledge is

Figure 4.2: Percentage of correct responses by verb profile for four-year-olds. (Error bars indicate standard error.)

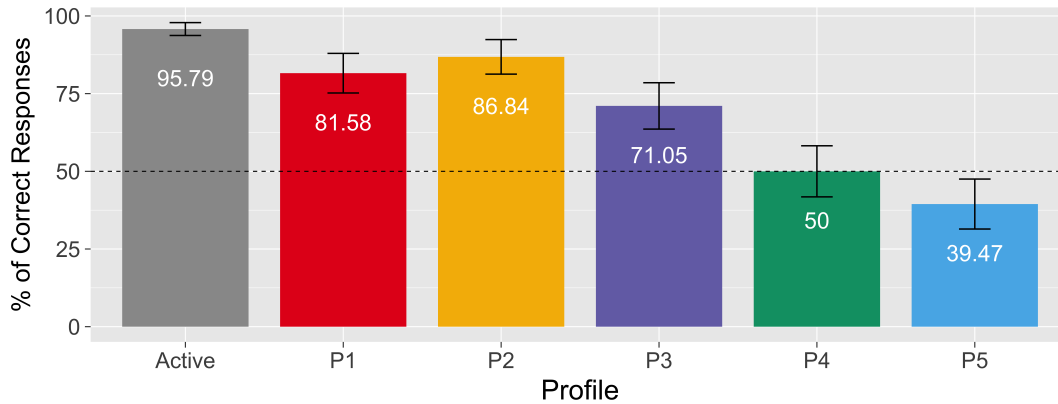

Figure 4.3: Distribution of accuracy rates by verb profile for four-year-olds.

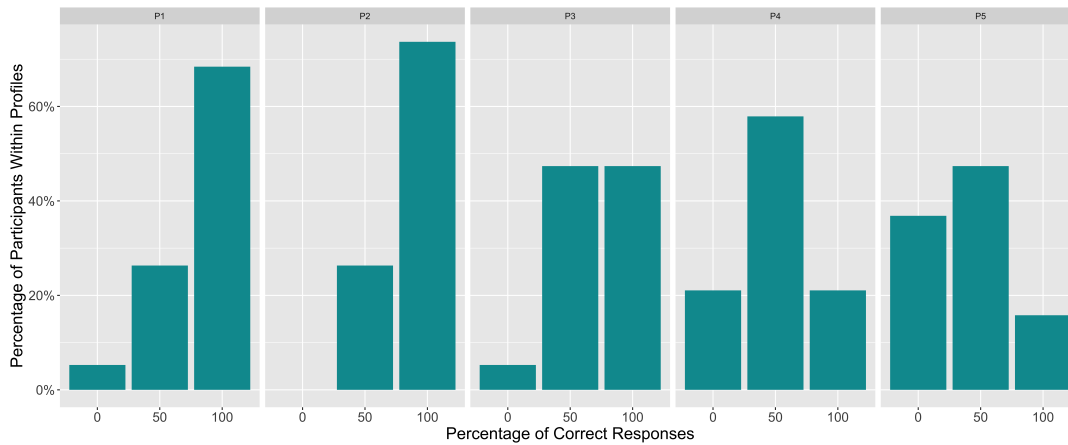

Table 4.4: Accuracy rates for adults and four-year-olds by verb profile, compared to chance (50%).

adults					four-year-olds				
Profile	Percentage Correct	<i>t</i>	<i>df</i>	<i>p</i>	Profile	Percentage Correct	<i>t</i>	<i>df</i>	<i>p</i>
1	100.00%	inf	9	<.001	1	81.58%	4.610	18	<.001
2	97.50%	19	9	<.001	2	86.84%	7.098	18	<.001
3	100.00%	inf	9	<.001	3	71.05%	3.023	18	0.003
4	97.50%	19	9	<.001	4	50.00%	0.000	18	0.500
5	95.00%	13.5	9	<.001	5	39.47%	-1.287	18	0.107

successful and, more importantly, with equal performance across all lexical profiles. So, these materials can be used to determine if a participant comprehends the verbal passive of verbs from all five profiles.

Turning to the four-year-olds, children were effectively at ceiling for the active control items, with 15 out of 19 children answering 100% of the items correctly (and the remaining 4 children answering 80% correctly); this means that children were paying attention to the experiment and knew the target verbs well enough to comprehend them in the active form.⁶⁰ For the passive items, children performed significantly above chance for Profiles 1, 2, and 3, but were no different from chance for Profiles 4 and 5 (Table 4.4).

Based on the discussion of the limitations of the synthesis of experimental studies in Section 4.1.2, I conducted several additional analyses.

4.2.4.1 Profile 1 vs. Profile 5

The synthesis of experimental studies found that Profile 1 had an AoA of three years old while Profile 5 had an AoA of five years old; so, I conducted a planned comparison between Profiles 1 and 5 on the sample of four-year-olds. The LEXICAL SEMANTIC PROFILE HYPOTHESIS would predict four-year-olds to perform differently on verbs from these two profiles. I found that this was indeed true: four-year-olds performed better on Profile 1 than Profile 5 ($W = 107$, $P = 0.0013$, Wilcoxon Signed-Rank Test). Looking at individual children's performance, 16 out of 19 children performed better on Profile 1 verbs than Profile 5, two children performed equally well with Profile 1 and Profile 5 verbs, and only one child performed worse on Profile 1 verbs than Profile 5 verbs. Additionally, Figure 4.3 shows that most children answered all Profile 1 test items correctly (13 out of 19 children) while 9 out of 19 children were correct on Profile 5 test items only 50% of the time. If children were consistently relying on the active interpretation whenever they encountered a passive that they could not comprehend, we might expect more children to be incorrect on all of the the Profile 5 test items. I interpret this to mean that four-year-olds'

⁶⁰It is possible that some of the included children who answered only four out of the five active controls correctly (4 of the 19) were guessing on the control items. This is because, at an individual level, 80% correct cannot be statistically distinguished from chance performance at the $p < 0.05$ level (using a binomial distribution). But, because this would only account for four children in the present sample, I will take the overall pattern to be valid.

performance does differ between these two profiles: in particular, four-year-olds were successful on Profile 1 verbs but not on Profile 5 verbs. Furthermore, children's unsuccessful performance on Profile 5 suggests that Profile 5 verbs have an AoA later than four years of age in English and that children may not be consistently using a strategy where they are interpreting the passive sentences that they do not understand in the active voice.

4.2.4.2 Profile 2

How would children perform on Profile 2 verbs when the material was controlled for accidental eventive readings of the verbs *surprise* and *frighten*? In particular, was the AoA for Profile 2 verbs four years old in English? I compared the four-year-olds' performance on Profile 2 to Profile 1 and Profile 5. I found that children performed no differently on Profile 2 than on Profile 1 ($W = -7$, $P =$ Not Significant, Wilcoxon Signed-Rank Test) but four-year-olds performed significantly better on Profile 2 than on Profile 5 ($W = 91$, $P = 0.0008$, Wilcoxon Signed-Rank Test). I take this to mean that four-year-olds were similarly successful with passives of Profile 1 and Profile 2 verbs and that the AoA for Profile 2 is, at the latest, four years old.⁶¹

4.2.4.3 Profiles 3 & 4

Because I was interested in how four-year-old children performed on Profiles 3 and 4 compared to Profiles 1 and 5, I performed similar pair-wise comparisons here as well. For Profile 3, four-year-old children performed no differently on Profile 3 than on Profile 1 ($W = 22$, $P = 0.1685$, Wilcoxon Signed-Rank Test) but four-year-olds performed significantly better on Profile 3 than on Profile 5 ($W = 69$, $P = 0.0084$, Wilcoxon Signed-Rank Test).

⁶¹Some of the Profile 2 verbs such as *surprise* and *frighten* have been argued by [Hirsch and Hartman \(2006\)](#) to fall under [Belletti and Rizzi's \(1988\)](#) "Preoccupare" class of psych verbs. If this is the case, then it is the active sentences of these verbs, rather than the passive, that should be difficult for young children to comprehend. Because children were effectively at ceiling for all active control items, including active sentences with *surprise* and *frighten*, we suspect that any predicted difficulty of verbs that fall under this "Preoccupare" class would appear in children younger than the ones we tested (cf. [Borga and Snyder 2018b](#) for evidence of French-speaking children's difficulty with active Object-Experiencers sentences until four years of age).

I take this to mean that four-year-olds were similarly successful with passives of Profile 1 and Profile 3 verbs and that the AoA for Profile 3 is, at the latest, four years old.

For Profile 4, I found that four-year-old children performed significantly different on Profile 4 than on Profile 1 such that children were worse on Profile 4 verbs ($W = 69$, $P = .0084$, Wilcoxon Signed-Rank Test). However, children's performance on Profile 4 was not significantly different from their performance on Profile 5 ($W = 14$, $P =$ Not Significant, Wilcoxon Signed-Rank Test). I take this to mean that four-year-olds had difficulty comprehending both Profile 4 and Profile 5 verbs in the passive.

4.2.4.4 Four-Year-Olds

It was unclear from the synthesis of experimental studies described in Chapter 2 if four-year-olds had a comprehension pattern similar to either three- or five-year-olds, or instead had their own separate comprehension pattern. To assess whether four-year-old children exhibit a pattern different from that of both three-year-olds and five-year-olds, I compared the three profiles on which these four-year-olds performed significantly above chance (Profiles 1-3) to the two profiles on which they did not (Profiles 4-5). I found that four-year-olds' performance was asymmetric: they performed reliably better on verbs from Profiles 1-3 than on verbs from Profiles 4-5 ($W = 161$, $P = 0.0005$, Wilcoxon Signed-Rank Test). This suggests that four-year-old children are exhibiting a pattern that is distinct from three- and five-year-olds.

4.2.4.5 Comparing Within Profiles

Figure 4.4 shows four-year-old children's performance in the task for each of the 10 verbs tested split by the two lists. In general, for each profile, children perform similarly across List A and List B verbs. While there are some notable differences – particularly with Profile 1 (*fix vs wash*) and Profile 4 verbs (*forget vs spot*) – these differences may be driven by small sample sizes. In particular, this experiment was a between-subjects design with

a sample size of 19 children (11 children for List A and 8 children for List B). So, lower performance for verbs like *wash* and *forget* may be driven by only having judgments from 11 and 8 children, respectively.

Figure 4.4: Percentage of correct responses for passive items by verb for four-year-olds. (Error bars indicate standard errors.)

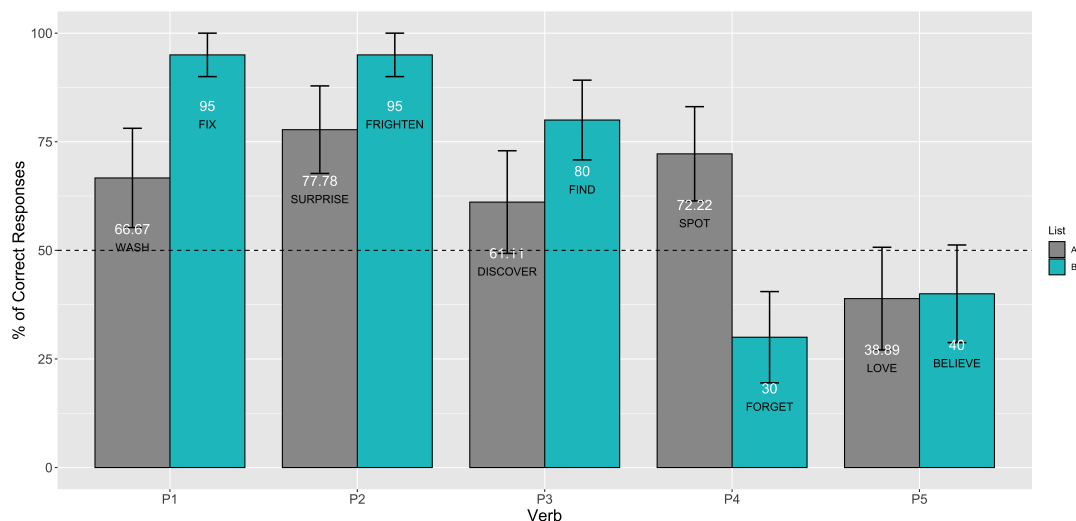

The much lower performance of the Profile 4 verb *forget* (apart from the low sample size of eight children) could also be due to the experimental test items for that verb – see [Appendix A.3](#). In particular, the *forget* test items may have been pragmatically ill-formed. Consider this example test item for the passive use of *forget*:

Narrator: Chase and Chloe are at school. Chase is playing by himself.

Chloe: Hey, I did not forget you! I played at your house last week.

Chase: You did? I forgot who was at my house last week.

In this scenario, it could be that children think *remember* is more pragmatically appropriate as a lead-in than *forget* (i.e., Chloe would say, “Hey, I remember you! I played at your house last week.”). However, to ensure the materials across all stories for all verbs were uniform, the target verb (here: *forget*) had to be used in the story leading up to the test sentence. Of course, this potentially pragmatically-odd test item was not an issue for

adult participants – adults performed near ceiling for *forget*. More generally, future studies could more thoroughly investigate children’s performance on the passive of Profile 4 verbs by (i) testing more children, (ii) creating better test items for *forget*, and (iii) testing more verbs that fall under Profile 4.

Additionally, not all of the constructed test materials met the “condition of plausible dissent” (Crain et al., 1996). This means that some of the test sentences, where the target answer was false (i.e., the puppet was being silly), were not necessarily felicitous because no alternative to the actual outcome was under consideration for that particular experimental context. Crain et al. (1996) claimed that this condition of plausible dissent is a crucial design feature for Truth Value Judgment Tasks in order to properly elicit children’s grammatical knowledge (see Sugisaki and Isobe 2001 for discussion for why the condition of plausible dissent may not always need to be satisfied). In the present study, test materials were constructed to be as uniform to each other as possible and simple enough to maximize the number of stories tested within a single session. This may have made all the stories less felicitous, and thus potentially caused four-year-olds not to correctly comprehend the passive for a particular verb when they might have comprehended it in a setup with plausible dissent. However, because all stories were alike in this regard, I expected this to have a global effect, potentially lowering correct comprehension rates across all profiles. So, the qualitative pattern I have reported here likely would remain the same. More generally, if four-year-olds do in fact comprehend Profile 4 verbs correctly in the passive, the qualitative results do not change. The four-year-olds would still pattern differently from the three- and five-year-olds, and the lexical semantic hypothesis is still supported as children of different ages seem to be able to comprehend progressively more lexical semantic profiles in the passive as they get older.

4.2.5 Discussion

Taken together, these results support the LEXICAL SEMANTIC PROFILE HYPOTHESIS: four-year-old children can successfully understand the long verbal *be*-passive for verbs in “earlier” profiles (Profiles 1, 2, and 3) but not the verbs in “later” profiles (Profile 4 and 5). In addition, four-year-olds seem to pattern differently than both the three- and five-year-olds in the synthesis of experimental studies: three-year-olds successfully comprehend verbs in the passive from Profiles 1 and 2, while five-year-olds comprehend verbs from all five profiles. One possible explanation for why the four-year-olds were not successful on Profile 4 verbs, as suggested by the synthesis of experimental studies, could be that performance was driven by the five-year-olds in those studies. Another possibility is that the lack of plausible dissent artificially depressed four-year-old performance on Profile 4; this would make four-year-old performance appear at chance when it in fact would not be in a more felicitous setup. Note that if four-year-olds do in fact comprehend Profile 4 verbs correctly in the passive, our qualitative results do not change. The four-year-olds would still pattern differently from the three- and five-year-olds. More generally, the distinction found in the lexical asymmetry patterns across the three different age groups supports our hypothesis that English-speaking children’s performance on verbal passive is linked to the lexical semantic profile of the verbs.

These results further suggest that four-year-old children have structural knowledge of the passive and are not strictly relying on linear word order. More specifically, if they were relying on linear word order, they would interpret passive sentences as active sentences (i.e., interpreting *Jake was loved by Isabelle* as “Jake loved Isabelle”). In the TVJ Task, they would then perform significantly below chance (e.g., giving the opposite response every time). Instead, four-year-olds performed above chance for verbs from Profiles 1-3, and no different from chance for verbs from Profiles 4 and 5. So, these results support four-year-olds having structural knowledge of the passive form.

With respect to prior studies, these results align with [Messenger et al. \(2012\)](#), who

found comparable performance between AGT-PAT verbs (Profiles 1 & 3) and OBJ-EXP verbs (Profile 2) in three- and four-year-old children. These results also align with those of [Maratsos et al. \(1985\)](#), who found that four-year-olds fail to comprehend non-ACTIONAL verbs like *love* and *remember*, both of which are Profile 5 verbs. I too found that four-year-olds did not understand the long verbal *be*-passive of *love*. However, I did find success with non-ACTIONAL verbs from Profile 2: *surprise* and *frighten*. Taken together, the LEXICAL SEMANTIC PROFILE HYPOTHESIS can improve upon prior explanations meant to account for the results of [Messenger et al. \(2012\)](#) and [Maratsos et al. \(1985\)](#). Furthermore, this hypothesis provides additional testable predictions such that any English verb that can be classified as one of these five lexical semantic profiles now has an approximate predicted AoA which we can test with children.

4.3 Summary

The LEXICAL SEMANTIC PROFILE HYPOTHESIS proposes that the lexical semantic features of a verb collectively predict when English-speaking children should successfully comprehend that verb in the long passive form. This is because these lexical semantic features serve as a signal for whether a verb can be used with the passive structure and that the passive structure itself is already in place. A Truth-Value Judgment Task with four-year-olds supported this hypothesis, with the children successfully understanding the long verbal passive of verbs with profiles predicted to have an earlier age of acquisition. From a knowledge representation standpoint, it is important to point out that the seven lexical semantic features included in the lexical semantic profiles investigated here were proposed as a description of the relevant verb properties. However, it is an open question if they are truly separate or if instead there is overlap that would be better represented with a smaller number of features (e.g., ACTIONAL and AGT-PAT might be better represented by a single feature as they had the same value for all five identified profiles). I leave this to future work.

The experimental results presented in this chapter also increase the empirical coverage of the synthesis of experimental studies to include more data about how four-year-olds understand the verbal passive. Future work can further expand the empirical foundation by additionally testing three- and five-year-old children on the same materials as for the four-year-olds we tested. Future work can also specifically evaluate the predictions of the LEXICAL SEMANTIC PROFILE HYPOTHESIS by testing children on more verbs for each profile.

5 | What Can't Be Readily Observed: A Model of Children's Intake for Classifying Passivizable Verbs⁶²

5.1 Introduction

The corpus analysis of child-directed speech in Chapter 3 presents a good overview of what realistic input is to English-speaking children learning the passive voice. Additionally, the detailed review summarized in Chapter 2 and the experimental findings in Chapter 4 strengthen our understanding of the developmental trajectory that children seem to go through with regards to classifying which verbs can and cannot passivize. Throughout this dissertation, I have been assuming that children's observed difficulty with regards to verbal passives of certain verbs is due to the learning problem of deciding which verbs can and cannot passivize in a particular language. If this is the case, then young children are also assumed to be adult-like in their structural representation of the verbal passive. Thus, the observed developmental asymmetry is not rooted in the maturation of structural knowledge of the passive but rather in the decision of which verbs are allowed to participate in the passive.

In investigating the source of the passive lexical verb asymmetry that we see in English-speaking children's performance, I found that some parts of this asymmetry can be ex-

⁶²The developmental computational model described in this chapter was work that I developed while visiting the University of California, Irvine, under the supervision of Lisa Pearl in Spring 2016. This research has been presented at the following workshops and conferences: BUCLD43, CompLang at MIT, Meaning and Modality Lab at Harvard University, and QuantLab at UCI. Parts of this chapter are based on [Nguyen and Pearl \(2019\)](#). I'd like to extend special thanks to Galia Bar-sever and Bahareh Noferest for assistance with corpus annotations.

plained by the input frequency of passives but only through the lens of lexical features: the verbs that children seem to acquire the earliest for the passive share lexical features with the most frequent verbs that children hear in the passive. Furthermore, I found that children's input of the passive is relatively consistent over time, which suggests that the trajectory observed in children's behavior with regards to passives of verbs from different lexical semantic profiles must be the result of something internal to the child, and may be a result of developmental changes in children's intake (i.e., what part of the linguistic input is actually harnessed by children to acquire their grammar) rather than external changes in children's input.

To concretely investigate the possibility that it is changes to children's intake that causes the observed developmental asymmetry, we can look whether there is a learning theory that would allow children to use the distribution of lexical features in their input in order to arrive at the developmental trajectory that we observe from their behavior. A theory of children's development of the passive will allow us to go beyond a formal description and generate testable predictions of children's behavior. Specifically, we need a theory of development in which: (i) the structural representation of the passive is in place early (i.e., by the time the learning process captured by the theory takes place), (ii) children's learning task is to figure out the set of verbs that do and do not passivize, (iii) children's intake (i.e., which part of the linguistic input that children are paying attention to) is developing over time. Development here is assumed to be the changes to children's intake and a number of factors could be driving this development. The goal of the investigation described in this chapter is to assess an approach in which differences in children's intake at different ages can capture the developmental trajectory that we observed in children's behavior. One scientific tool that we can use to develop a theory of children's language learning is developmental computational modeling, which I will describe in the next section.

5.1.1 Why Developmental Computational Modeling?

A theory of language learning hypothesizes the procedure by which children arrive at the target adult grammar given their hypothesis space (i.e., the realm of possible hypotheses that children are entertaining given a learning problem) and the evidence that is available to them in the input. Thus, a developmental computational model is a tool that can be employed to embody such a learning theory by: (i) making all of the components of such a procedure explicit, (ii) evaluating whether such a procedure will successfully lead to the target output, and (iii) determining precisely the factors (as implemented explicitly in the model) that make the theory work (or not work) (Pearl, 2020).

5.1.2 What Computational Modeling Can (Not) Do

Because a computational model is an embodiment of a theory, we need to actually have a theory of language acquisition where every relevant detail (i.e., what is needed to generate a testable prediction) is specified. This is because a computational model will not be able to function or generate a testable prediction unless all of the parts needed are specified. Thus, in order to implement a learning procedure in a computational model, we are forced to specify all of the individual and necessary components of an acquisition theory that we may not have realized we needed to be explicit about. A computational model of such an explicit theory of acquisition can generate testable predictions, which we can then evaluate against empirical data from children.

When we evaluate the predictions of a computational model against empirical data, either the predictions match or they do not. If the model's predictions match children's data, then this is proof of concept that the specific instantiation of the acquisition theory that we implemented in the computational model is one way that acquisition could proceed. But it is important to note that just because this is one way in which acquisition could work does not mean that other acquisition theories could not also work. That is, just because this theory could be right does not mean other theories are clearly wrong.

The model has nothing to say about other theories, only about the theory it implements. Furthermore, if a model's predictions do not match empirical data from children, this is evidence against the specific instantiation of the acquisition theory that were implemented in the model. Notably, this is not necessarily evidence against the acquisition theory overall, as the source of the problem could be in the specific instantiation of the theory component rather than all instantiations of the theory. So one limitation of interpreting results that come from a computational model is that there are many components of the proposed learning theory that must be made explicit in order for a model to be able to make predictions about children's behavior, and these component instantiations may or may not be crucial for the high-level view of the theory (e.g., if a theory assumes probabilistic learning, but a Bayesian learner fails, it could be that the model's implementation of Bayesian inference is not the right kind of probabilistic inference, and some other kind of probabilistic inference would have worked). However, one very useful benefit is that when a model's prediction does or does not match empirical data from children, we can "look under the hood" (so to speak) of the model and determine exactly the components that make the model work or not work.

In the next section, I will give a concrete example of making components of a learning theory explicit via developmental computational modeling through the lens of learning the set of verbs that allow passivization.

5.1.3 The Passive Lexical Verb Asymmetry as a Classification Problem

As previously discussed, we can view children as needing to solve two learning problems when it comes to acquiring the passive: (i) what is the structural representation of the passive, and (ii) what is the set of verbs that do (not) allow passivization? I assume for this dissertation that the passive lexical verb asymmetry is a consequence of children trying to learn which verbs passivize in English. I propose that while frequency of individual verbs may not matter for the comprehension of passives, the frequency of lexical

features would be directly impactful. Specifically, I aim to investigate whether there is a learning theory in which children are combining the collective evidence from lexical features in verbs that passivize in order to decide if a particular verb with a particular collection of features ought to passivize in English. Currently, I have been assuming that there are eight lexical features that underlie children's acquisition of the set of passivizable verbs. But it is unclear if we should be assuming that all eight lexical features matter for children, only one lexical feature matter, or somewhere in-between. A developmental computational model is a useful tool that would allow us to explore all of these possibilities. The hypothesis space that children are presumably navigating through is large given that we have attempted to narrow down the number of lexical features to this set of eight. If we assume that children's intake is a filtered set of the linguistic input, then the hypothesis space is composed of hypotheses that filter input based on all, some, or none of these eight features (i.e., care about none of the features ($8 \text{ choose } 0$) + just care about 1 of the features ($8 \text{ choose } 1 = 8$) + just care about 2 of the features ($8 \text{ choose } 2 = 28$), just care about 3 of the features ($8 \text{ choose } 3 = 56$)... + care about all 8 lexical features ($8 \text{ choose } 8 = 1$) – this works out to 256 input filters, which is also 2^8 (care or not about each of the eight lexical features)). Thus, what might an explicit learning theory of this kind look like?

In this chapter, I will describe one specific implementation of this acquisition theory using Bayesian modeling, where children's prior beliefs and abilities associated with the passive structure also impact their observed passivization behavior. I will first review what Bayesian modeling is and why this method is a plausible component (specifically, the inference component) in theories of development. I will then describe the specific developmental model that I have implemented in order to understand children's behavior with regards to passives of different verbs. Specifically, I used a Bayesian model which combines the available evidence of the distribution of lexical features from children's input with their prior beliefs and abilities to produce the lexical verb asymmetry that we observe in their behavior at age 5. I conclude this chapter with a discussion of testable

predictions that were gained from the developmental computational model and future extensions that generate testable predictions for ages 3 and 4, since we have empirical data on that for familiar verbs. The next chapter will investigate the lexical feature sensitivity specifically for novel verbs.

5.2 Bayesian Modeling

Bayesian modeling is one kind of learning via probabilistic strategy and is often used for cognitive development modeling, as it can capture human behavior very well (e.g., [Perfors et al., 2011](#); [Pearl and Mis, 2016](#)). This specific way of developmental modeling involves prior assumptions about the probability of different options (typically referred to as hypotheses) and an estimation of how well a given hypothesis fits the data (for a detailed overview of this technique for modeling language acquisition, see [Pearl and Goldwater 2016](#)).

5.2.1 Bayes' Theorem and its Basic Components

A core assumption that a Bayesian model makes is that the learner is updating her (posterior) beliefs on the basis of the observed data (likelihood) combined with her prior beliefs (prior). So, for any hypothesis h that children may be entertaining from their hypothesis space H and the observed data D , a modeled child in a Bayesian model has the goal of determining the probability of that hypothesis h being the actual hypothesis that generated the data D , which we can write as $P(h|D)$ and refer to as the posterior of the hypothesis. The posterior of a hypothesis in this type of computational model is calculated via Bayes' Theorem, which is shown in Equation 5.1 below.

$$P(h|D) = \frac{P(D|h) * P(h)}{P(D)} \quad (5.1)$$

In the numerator, the likelihood of data D given hypothesis h represents how well the

hypothesis predicts the data and is written as $P(D|h)$, whereas the prior expresses the probability of the hypothesis regardless of any data, which we write as $P(h)$. As noted by Pearl (2020), the prior probability of a hypothesis is where modelers will often implement certain considerations regarding the complexity of the hypothesis. More complex hypotheses may have lower prior probabilities. This is because there may be a cognitive penalty for being more complex, due to the cognitive cost of working with that hypothesis (construction, access, deployment, etc.). In the denominator, $P(D)$ expresses data D under any hypothesis and serves as the normalizing factor and ensures that the posteriors generated by all of the hypotheses under consideration sum up to 1, which we can rewrite as Equation 5.2 below.

$$P(h|D) = \frac{P(D|h) * P(h)}{\sum_{h_i \in H} P(h_i|D) * P(h_i)} \quad (5.2)$$

In designing a Bayesian model that follows the equation in (5.1), there are three questions about the acquisition procedure that we need to consider: (i) what the nature of the learning task is (i.e., what does the learner need to achieve), (ii) what sources of information are available, and (iii) what the inductive biases of the learner are (i.e., what kinds of hypotheses about the grammar are easy, difficult, or impossible to learn or deploy in real time). We can connect these questions to a procedure that is concerned with learning the set of verbs that passivizes in English, such that: (i) the nature of the learning task is whether to comprehend a particular lexical profile in the passive or not; (ii) the source of information for children will be in the distributions of lexical features in their linguistic input; and (iii) the learner should be biased as to whether passivization is easy or hard to deploy, compared to an alternative, i.e., the active.

I demonstrate how children's considerations of the distribution of lexical features in their input could be explicitly implemented in a Bayesian model in the next section.

5.3 Using Bayesian Modeling to Understand the Passive Lexical Verb Asymmetry

Over the past 20 years, there has been a growing number of studies that use Bayesian modeling in order to understand different domains of language acquisition. These domains include phonetic categorization (Feldman et al., 2009; Feldman, 2011; Feldman et al., 2013), word segmentation (Goldwater, 2007; Goldwater et al., 2009), word learning (Xu and Tenenbaum, 2007; Frank et al., 2009), and syntax-semantics mappings (Regier and Gahl, 2004; Pearl and Lidz, 2009; Foraker et al., 2009; Pearl and Mis, 2016; Pearl and Sprouse, 2013), among others. This suggests that for the case of harnessing lexical features to learn the set of verbs that allow passivization in English, Bayesian modeling can be an appropriate tool for investigation.

5.3.1 Nature of the Learning Task

The child's goal here is to decide whether a verb from a specific profile should be passivized: this is a classification problem. In particular, given the lexical features comprising a particular profile and the child's prior beliefs and abilities associated with the passive, should that profile be part of the class of passivizable profiles (+pass) or not (-pass)? The +/ - pass classification impacts children's predicted behavior in experiments involving the passive structure: if a verb is part of the +pass class, the child can (more easily) comprehend the passive form; if a verb is part of the -pass class, the child cannot. So, a successful modeled five-year-old child will classify all five verb profiles from Table 5.2 as +pass, because five-year-olds demonstrate successful comprehension of passives for familiar and known verbs with these profiles (see Chapter 2 for discussion of the empirical data from five-year-old children).⁶³

⁶³I assume that children's behavior on different verbs of a class reflect generalizations that they have made about that class, but as we will see in Chapter 6, the assumption that five-year-old children passivize verbs from all five lexical profiles may not hold once we look at their behavior on novel (i.e., nonsense or

5.3.2 Adapting Bayes' Theorem for Classifying Passivizable Verbs

The modeled child's reasoning process, which combines the probabilistic cues coming from the feature frequency in children's input with the child's prior about the passive, is implemented via Bayesian inference, as shown in Equation 5.3. In the following sections, I will explain each part of this equation.

$$\overbrace{P(+\text{pass}|v_{f_1}, \dots, v_{f_8})}^{\text{Posterior}} = \frac{\overbrace{\prod_{f_i \in F} P(v_{f_i} | +\text{pass})}^{\text{Likelihood Probability}} * \overbrace{P(+\text{pass})}^{\text{Prior}}}{\sum_{h_{+\text{pass}, -\text{pass}}} \left(\prod_{f_i \in F} P(v_{f_i} | +\text{pass}) * P(+\text{pass}) \right) + \left(\prod_{f_i \in F} P(v_{f_i} | -\text{pass}) * P(-\text{pass}) \right)} \quad (5.3)$$

5.3.2.1 Posterior

The goal of the modeled child here is to determine if a verb that has a particular lexical semantic profile should be part of the +pass class, i.e., $P(+\text{pass}|v_{f_1} \dots v_{f_n})$. Of the set of possible lexical features that we are considering, which we can refer to as F , the modeled child can consider all or some of those lexical features. For our purposes, there are eight lexical features in this set ($f_1 \dots f_8 \in F$). So, if a lexical semantic profile of a verb contains a particular collection of feature values ($v_{f_1} \dots v_{f_n}$, where v stands for *value*), then the modeled child calculates the posterior probability, $P(+\text{pass}|v_{f_1} \dots v_{f_n})$.⁶⁴

5.3.2.2 Likelihood Probabilities

The likelihood probability of a lexical semantic profile is the probability of the specific collection of lexical features appearing in the input in the passive. The likelihood captures how well the current data (i.e., the distribution of lexical features in the input) fit the hy-

nonce) verbs.

⁶⁴As I will discuss in Section 5.4.3, it is possible to not utilize all of the lexical feature information available in the input. This is why Equation 5.3 encodes lexical values as v_{f_n} rather than v_{f_8} .

pothesis (i.e., the passivizability of a given verb). The higher the probability, the better the data fits the hypothesis. Thus, if these lexical features have a high probability of appearing when a verb is passivized, then there is a strong fit between the feature values and the hypothesis that a lexical profile will be passivizable.

The likelihood probability can be calculated for a given lexical profile appearing in the passive (+pass) or active (-pass) class. This calculation depends on the probability of a particular feature, f_i , having a particular value, v_{f_i} , (e.g., ACTIONAL=1), given that the verb is +pass. This is interpreted as the likelihood of $v_{f_i}|+pass$, shown as $P(v_{f_i}|+pass)$ in Equation 5.3. The probabilities for all lexical features under consideration are multiplied together to calculate the collective likelihood of this feature profile, given +pass – this is shown as $\prod_{f_i} P(v_{f_i}|+pass)$. Note that this way of calculating likelihood assumes the feature values are independent of each other (i.e., the lexical features are independent of each other – this is a working assumption, given the origin of the current features, see Chapter 2). This is what allows us to multiply the individual probabilities together. This is an assumption that can be relaxed in future work (i.e., some features might be related, and not independent) and could yield a different likelihood calculation.⁶⁵

5.3.2.3 Prior

The prior probability is the probability of any verb allowing passivization, which we can write as $P(+pass)$. This is meant to capture anything that the child brings to the passivization task independent of their linguistic input. Thus, it can include both the child's prior knowledge about which verbs are passivizable (i.e., the size of the passivized instances that the child has experienced vs. the non-passivized (active) instances) and the passive structure itself, as well as the child's ability to deploy that passivization knowledge in real time during an experiment. So, this prior on the passive structure intuitively captures any

⁶⁵In order to maintain the assumption that these lexical features are independent for the purposes of likelihood calculations, future theoretical work would need to be done in order to identify the clusters of features that function independently.

inherent complexity of the passive structure, wherever that cost originates. For example, the passive may be costly because it is a more complex structure syntactically, or because it is a more complex structure to process in real time even when children have the structural knowledge (e.g., Stromswold et al., 2002; Collins, 2005b; Hirotani et al., 2011; Huang et al., 2013; Mack et al., 2013; Feng et al., 2015; Deen et al., 2018).

5.3.2.4 Normalizing Factor

We can normalize a verb’s posterior probabilities for appearing in the passive (+pass) or not (-pass; i.e., $P(+pass|v_{f_1} \dots v_{f_n})$ and $P(-pass|v_{f_1} \dots v_{f_n})$, respectively) in order to calculate whether the likelihood that a verb will be +pass is greater than 0.50 (or 50%) as shown in Equation 5.4. So the success rate of a modeled child for comprehending the passive in a given instance can either be greater or less than 50%. We can interpret this as a child in real-life succeeding (>50%) or failing (<50%) at comprehending a verb with a specific lexical profile in the passive.

$$\frac{P(+pass|v_{f_1} \dots v_{f_8})}{P(+pass|v_{f_1} \dots v_{f_8}) + P(-pass|v_{f_1} \dots v_{f_8})} > 0.50. \quad (5.4)$$

5.3.3 Empirical Data on Children’s Passives

To empirically ground a developmental computational model of the English verbal passive, there needs to be (i) a clearly defined output behavior as the target of development, and (ii) a reasonable sample of input to learn from which the model, representing a modeled five-year-old child, will use as input.

As the target output for the developmental model, I consider the 30 verbs English-speaking children have been experimentally attested to comprehend the passive use of by age 5 (as discussed in Chapter 2): *carry, drop, eat, hold, hug, kick, kiss, push, shake, wash, annoy, chase, frighten, hit, pat, pull, scare, shock, squash, surprise, upset, find, fix, forget, paint, spot, hate, like, love, and remember*. These 30 verbs fall under five lexical semantic profiles

(Table 5.2, modified from Table 2.10), which are comprised of values for eight lexical features (Table 2.4 reproduced as Table 5.1 below). Successful comprehension was defined as children performing significantly above chance in any of the 12 experimental studies reviewed in the synthesis of experimental studies. Given that chance is 50% (either the child does or does not understand the passive for the stimulus presented), this can be operationalized as the modeled child deciding that verbs of those profiles can be passivized with a probability above 50% (as discussed in the previous section on posterior probabilities).

Table 5.1: Descriptive features derived from prior experimental studies, including example verbs with (1) and without (0) that feature.

Feature	Signal	+	-
ACTIONAL	Observable	<i>eat</i>	<i>scare</i>
STATIVE	Simple present tense acceptable in an “out of the blue” context	<i>scare</i>	<i>eat</i>
VOLITIONAL	“deliberately <i>VERB</i> ” is acceptable	<i>annoy</i>	<i>see</i>
AFFECTED	X affects Y	<i>annoy</i>	<i>like</i>
OBJ-EXP	–ACTIONAL where object is Experiencer	<i>frighten</i>	<i>chase</i>
SUBJ-EXP	–ACTIONAL where subject is Experiencer	<i>like</i>	<i>annoy</i>
AGT-PAT	+ACTIONAL where θ -roles = Agent, Patient	<i>eat</i>	<i>whisper</i>
TRANS	Allows an object to follow	<i>scare</i>	<i>fall</i>

As a realistic sample of the input that a child would have experienced all the way until age 5, I used all verbs extracted from the same corpora as analyzed in Chapter 3: the Brown-Adam, Brown-Eve, Brown-Sarah (Brown, 1973), and Valian corpora (Valian, 1991) from the CHILDES Treebank (Pearl and Sprouse, 2013). As a reminder, this corpus collectively consists of 113,024 utterances (62,772 verb tokens, 742 verbs) of speech directed at children ages 1;06-5;01. The extracted verbs were also annotated for their lexical se-

Table 5.2: Profiles for example verbs (in *italics*) with an observed AoA by age five. Profiles are comprised of lexical semantic and syntactic features, with 1 indicating the verb is *+feature* and 0 indicating the verb is *-feature*.

Profile	<i>carry</i>	<i>annoy</i>	<i>find</i>	<i>forget</i>	<i>hate</i>
	1	2	3	4	5
ACTIONAL	1	0	1	0	0
STATIVE	0	1	0	0	1
VOLITIONAL	1	1	0	0	0
AFFECTED	1	1	0	0	0
OBJ-EXP	0	1	0	0	0
SUBJ-EXP	0	0	0	1	1
AGT-PAT	1	0	1	0	0
TRANS	1	1	1	1	1

mantic profiles (as in Table 5.2) and verb frequencies (passive use, active use, and overall use) were calculated (see Chapter 3 for further details). This allowed for subsequent estimations of the frequency of verb features in the set of verbs that are observed to be passivizable (+pass) and not (-pass) in children’s input.

5.4 Where Do the Numbers Come From?

5.4.1 Estimating Likelihood Probabilities

To estimate the likelihood probabilities of individual features, I used the input frequencies from the corpus analysis conducted in Chapter 3. Specifically, I used the distribution of lexical features from child-directed speech in the passive and active voice by converting Table 3.5 from Chapter 3 into probabilities, which I show in Table 5.3. Furthermore, for this computational model, I looked at the posterior probabilities for both +pass and -pass, which requires the likelihood probabilities of these eight lexical features in the active voice as well. The reason that we are looking at the distributions over individual instances of verbs used in the passive versus active use is because any particular verb can appear in the active (-pass) or the passive (+pass). So, the modeled child is assessing

the distribution of lexical information in all of the passive and active instances and figuring out differences in the distribution are relevant for making a generalization regarding when to passivize a particular verb. For example, looking at Table 5.3, it may initially seem like the +ACTIONAL feature would be really useful for a child because +ACTIONAL is highly probable in the passive (i.e., 94%). But the +ACTIONAL feature is also highly probable in the active use as well (i.e., 89%). In contrast, the +AFFECTED and +TRANSITIVE seem to differ quite a bit between +pass and -pass, with +pass being much more skewed towards +AFFECTED and +TRANSITIVE.

Table 5.3 shows the likelihood probabilities of our eight lexical features in the passive, $P(v_{f_i}|+pass)$, and active, $P(v_{f_i}|-pass)$, in child-directed speech.⁶⁶ Table 5.4 in section 5.4.2 shows an example likelihood calculation for the profile of the verb *annoy*.

Table 5.3: Likelihood probabilities for individual features, calculated from child-directed speech input, for verbs in the passive ($P(v_{f_i}|+pass)$, left) and active voice ($P(v_{f_i}|-pass)$, right).

Feature Value	$P(v_{f_i} +pass)$		$P(v_{f_i} -pass)$	
	+	—	+	—
ACTIONAL	0.94	0.06	0.89	0.11
AFFECTED	0.86	0.14	0.58	0.42
STATIVE	0.07	0.93	0.09	0.91
VOLITIONAL	0.93	0.07	0.79	0.21
AGT-PAT	0.89	0.11	0.67	0.33
OBJ-EXP	0.05	0.95	0.02	0.98
SUBJ-EXP	0.03	0.97	0.05	0.95
TRANS	0.96	0.04	0.75	0.25

5.4.2 Estimating Prior Probabilities

As discussed in Section 5.3.2.3, the prior probability represents the probability of any verb allowing passivization. In other words, the prior is the estimation of what the child knows about passivization independent of input frequencies and encapsulates both the child's

⁶⁶ $P(v_{f_i}|+pass)$ can be read as the probability of a feature (f_i) with a particular value, v , which is either +FEATURE or -FEATURE, in the set of verbs used in the passive in the input (+pass). For example, for Table 5.3, the probability of a +TRANSITIVE verb in the active voice (i.e., $P(+Trans|-pass)$) is 0.75 or 75%.

grammatical knowledge of the passive as well as the child’s ability to deploy that knowledge. But, while we can estimate likelihood probabilities from the input frequencies, it is unclear *a priori* what the prior on passivization should be. Thus, as a first attempt at developing an explicit instantiation of an acquisition theory, I will use this opportunity to define what the prior would need to be in order for five-year-olds to passivize the verbs they do, assuming they were learning from the frequency of these lexical and syntactic features in their input. That is, because we have empirical estimates of the likelihood (from input frequencies) and the desired output behavior (i.e., the ability to passivize all five lexical semantic profiles of interest), I can derive an estimate for the prior on passivization that generates the desired output behavior when that prior and the likelihood are combined. This estimated prior can be interpreted as how costly five-year-olds would view passivization to be as a linguistic structure, irrespective of which verbs it applies to. It is important to note here that the notion of how costly a linguistic structure is can be attributed to either difficulty with derivations of a complex grammatical structure or the processing cost of deploying such a structure or a combination of both. I return to this discussion in Section 5.7.1.

To calculate the necessary prior, $P(+pass)$, for a verb in the +pass class (as in Equation 5.3), I compare the likelihoods of +pass and –pass, which I refer to as l_{+pass} and l_{-pass} , respectively. The logic behind this mathematical derivation is shown in Equations 5.5a–5.5d. To start in Equation 5.5a, for the five lexical profiles that we want the model to successfully predict as passivizable, the posterior probability of a verb that has one of those five profiles in the +pass class, i.e., $P(+pass|v_{f_1} \dots v_{f_n})$, needs to be greater than the posterior probability of that verb in the –pass class, i.e., $P(-pass|v_{f_1} \dots v_{f_n})$. Given the posterior calculations in Equation 5.3, we can replace the terms in Equation 5.5a with the prior · likelihood equivalents as shown in Equation 5.5b. In Equation 5.5c, because the sum of the probabilities of a verb allowing passivization and not allowing passivization is assumed to be 1, $P(-pass)$ is replaced with its equivalent $1 - P(+pass)$. “Solving” for

$P(+pass)$ in Equation 5.5c will give us a way to calculate the prior probability using the likelihood ratio shown in Equation 5.5d. This likelihood ratio will help us to determine the minimum the prior would need to be to allow passivization of the verb in question. I show a sample calculation of the minimum $P(+pass)$ for the verb *annoy* in Table 5.4.

$$P(+pass|v_{f_1} \dots v_{f_8}) > P(-pass|v_{f_1} \dots v_{f_8}) \quad (5.5a)$$

$$l_{+pass} \cdot P(+pass) > l_{-pass} \cdot P(-pass) \quad (5.5b)$$

$$l_{+pass} \cdot P(+pass) > l_{-pass} \cdot (1 - P(+pass)) \quad (5.5c)$$

$$P(+pass) > \frac{l_{-pass}}{l_{+pass} + l_{-pass}} \quad (5.5d)$$

Table 5.4: Calculation of the likelihood probability (l_{pass}) and the prior probability ($P(+pass)$) for *annoy*, given the likelihood probabilities of its feature profile. The likelihood ratio indicates the minimum +pass prior probability could be and still allow passivization for the profile of the verb *annoy*.

Profile Features	Profile of <i>annoy</i>	Likelihood $P(v_{f_i} +pass)$	Likelihood $P(v_{f_i} -pass)$
ACTIONAL	0	0.076	0.110
STATIVE	1	0.067	0.092
VOLITIONAL	1	0.915	0.768
AFFECTED	1	0.847	0.528
OBJ-EXP	1	0.050	0.017
SUBJ-EXP	0	0.974	0.948
AGT-PAT	0	0.127	0.365
TRANS	1	0.940	0.710
$\prod_{f_i \in F} P(v_{f_i} c_{pass})$ of <i>annoy</i>		l_{+pass}	l_{-pass}
		0.0000223071	0.0000171389
Prior minimum $\frac{l_{-pass}}{l_{+pass} + l_{-pass}}$		0.434	

5.4.3 Selective Use of Lexical Features

As previously discussed, although all eight lexical features are available to children in their linguistic input for verbs in the passive voice, children's intake, or what is harnessed

by children, may not be a direct reflection of their input. In other words, the distributional information of the lexical features that children are utilizing for this learning problem may be a “filtered” version of their linguistic intake. In developmental computational modeling, differences in children’s input and intake may be operationalized as a modeled child selectively attending to the available information and applying an input filter that causes them to ignore information that is otherwise available in their input (Pearl and Weinberg, 2007; Gagliardi et al., 2012; Lidz and Gagliardi, 2015; Gagliardi et al., 2017). The Bayesian model that is implemented in this chapter includes the possibility that children may be selectively attending to a proper subset of the eight lexical features that are available in their linguistic input in addition to attending to all eight lexical features.

While there are many ways to implement selective attention, I adapt the modeled child to filter the input by selectively attending to one or more features in a categorical fashion.⁶⁷ That is, when a feature is attended to, it is completely heeded (i.e., the child incorporates its information with a probability of 1); when it is not attended to, it is completely ignored (i.e., the child incorporates its information with a probability of 0). No other weighting of features is used. This selective attention impacts the likelihood calculation, as shown in Table 5.5 for the verb *annoy*, when only the features ACTIONAL and TRANSITIVE are heeded. The other six features (which appeared in Table 5.4) are ignored in the calculation. From this example calculation, selectively attending to a subset of the eight lexical features yields a passive prior minimum above 0.50 (compared to 0.43 in Table 5.4), which indicates the child would need to slightly favor passivization in order for a verb with a lexical profile of [-ACTIONAL, +TRANSITIVE] to be classified as passivizable. To reiterate, the model in which the child is only attending to ACTIONAL and TRANSITIVE is failing to yield five-year-old passivization behavior because it requires passivization to be easier than not (with a prior >0.50) in order for five-year-olds to passivize Profile 2

⁶⁷For examples of input filtering that are not strictly categorical, see Gagliardi et al. (2017) and Forsythe and Pearl (2020). I leave it to future work to test how the results would differ when input filtering is operationalized in a different manner.

verbs. But, since I am assuming that passivization should be harder than not for children, this model fails in its evaluation.⁶⁸

Table 5.5: Calculation of the likelihood probability (l_{pass}) and the prior probability ($P(+\text{pass})$) for the verb *annoy* if only the features ACTIONAL and TRANSITIVE (TRANS) were attended to. The likelihood ratio indicates the minimum the +pass prior probability could be and still allow passivization for the profile of the verb *annoy*

Profile Features	Profile of <i>annoy</i>	Likelihood $P(v_{f_i} +\text{pass})$	Likelihood $P(v_{f_i} -\text{pass})$
ACTIONAL	0	0.076	0.110
TRANS	1	0.940	0.710
$\prod_{f_i \in F} P(v_{f_i} \text{pass})$ of <i>annoy</i>		0.0714	0.0781
Prior minimum $\frac{l_{-\text{pass}}}{l_{+\text{pass}} + l_{-\text{pass}}}$		0.522	

With this in mind, I compare models of different input filters to investigate if there is any subset of features from the set of eight capable of yielding five-year-old passivization behavior. Given that each of the eight lexical features can either be heeded or not, there are 256 possible input filters that we can do model comparisons for ($2^8 = 256$).⁶⁹ Notably, these possible models that I evaluated include paying attention to all of the lexical features or none of the lexical features.

5.5 Evaluating Model Success

Here, there are two benchmarks that the Bayesian model must meet in order to be considered a successful model: (i) prior minima are calculated for each of the five lexical profiles of interest and (ii) the prior minimum for +pass class is <0.50 . Recall that the prior probability represents the cost of passivization for children independent from input frequencies. I assume for this model that passivization is harder than not (i.e., more costly in whatever relevant sense than other linguistic structures that could have been used) and

⁶⁸This suggests that the number of successful models would change if we were to set a different threshold for the prior. Future work would need to be done to motivate a different prior threshold and the testable predictions of the models that are set to that different threshold.

⁶⁹See [Appendix A.4](#) for a table of all 256 input filters considered for this investigation.

thus the prior minimum should be <0.50 . As shown in Section 5.4.2, a prior minimum is the minimum prior that is needed in order for the posterior probability to be greater than 0.50. This means that we can rely on just the prior minimum in order to assess whether the modeled child would predict a verb to be passivizable. So, if the goal of the modeled child is to classify Profiles 1-5 as passivizable and the prior minimum needs to be <0.50 , then a model with a particular input filter is considered successful if the prior minimum for each of the five lexical profile is <0.50 .

Take Table 5.4 and Table 5.5 as examples of two models for comparisons. Since the verb *annoy* belongs to Profile 2 and Profile 2 verbs should be classified as passivizable by age 5, we want to evaluate whether the prior minimum calculated for Profile 2 through two types of input filters is <0.50 . In Table 5.4 where the modeled child is heeding to all eight lexical features equally, the feature input frequencies for *annoy* yield a passive prior minimum of 0.44. So, this model would predict that *annoy* should be passivized by five-year-old children, based on the lexical and syntactic feature frequencies considered here. In Table 5.5 where the modeled child is only heeding two lexical features, ACTIONAL and TRANSITIVE, the passive prior minimum is 0.52, which fails our benchmark of prior minima needing to be <0.50 . Thus, this model, implementing a particular input filter, is interpreted as failing to yield five-year-old passivization behavior.

5.6 Model Comparisons and Connections to Passive Behavior in 5-Year-Old Children

We can start with the initial assumption that children are attending to all the features available in the input (ALL FEATURES) and thus no information is filtered out. Table 5.6 shows the minimum +pass prior necessary for passivization of each of the five lexical profiles of interest.

Recall that if we assume that the passive should be more costly than not, we should

Table 5.6: The minimum priors on the passive structure required to yield five-year-old passivization behavior for the five lexical profiles of interest, when all features are heeded. Priors below 0.50 are in **bold**.

	<i>carry</i>	<i>annoy</i>	<i>find</i>	<i>forget</i>	<i>hate</i>
	1	2	3	4	5
ALL FEATURES	0.21	0.43	0.81	0.98	0.99

look for +pass priors <0.50 as a reasonable estimate. When all features are heeded, only verbs from profiles 1 and 2 have a prior like this (profiles 3-5 require a prior that significantly or nearly exclusively favors passivization: 0.81-0.99). This would mean that in order to passivize verbs from profiles 3-5, five-year-olds would need to find the passive very, very easy – this is what prior minimums that high would indicate. Given experimental evidence to the contrary (e.g., [Stromswold et al., 2002](#); [Collins, 2005b](#); [Hirovani et al., 2011](#); [Huang et al., 2013](#); [Mack et al., 2013](#); [Feng et al., 2015](#); [Deen et al., 2018](#)), it seems that if five-year-old children were attending to the input frequency of all these features, they would be unlikely to generate their observed passivization behavior for these five verb profiles. I interpret this result to mean they may not be attending to all these features.

With this in mind, we can investigate if there is any subset of features from our set of eight capable of yielding five-year-old passivization behavior. There are 256 possible filters, given that each of the 8 features can be heeded or not ($2^8 = 256$). Table 5.7 shows the successful filters capable of yielding passive prior minimums less than 0.50, of which there were only two. So, our model can generate the observed five-year-old passivization behavior as long as children either attend to the TRANSITIVITY feature exclusively, or attend to both the TRANSITIVITY and OBJECT-EXPERIENCER features. These are the only two cases where the minimum passivization prior is below 0.5 for all five verb profiles. So, this model would predict that five-year-olds can find the passive harder than not (a passivization prior <0.50) and passivize the verbs they have been observed to, as long as they attend to only the TRANSITIVITY of the verbs in their input or the TRANSITIVITY and OBJECT-EXPERIENCER feature.

Table 5.7: Successful input filters that yield minimum priors on passivization below 0.50 and still generate five-year-old passivization behavior for the five lexical profiles of interest, given different collections of features to selectively attend to.

	<i>carry</i>	<i>annoy</i>	<i>find</i>	<i>forget</i>	<i>hate</i>
	1	2	3	4	5
TRANS	0.43	0.43	0.43	0.43	0.43
TRANS+OBJ-EXP	0.44	0.21	0.44	0.44	0.44

5.7 Discussion

Using developmental modeling, I have provided empirical evidence for two ideas: (i) English-speaking children’s passivization behavior can be explained by a model according to which they selectively attend to the available lexical feature information in their input (i.e., filtering their input), and (ii) children view the passive structure as somewhat costly *a priori*, though not excessively so, i.e., less than 0.5, but not really close to 0 – see discussion in the next subsection. I demonstrated this via an existence proof implemented in a Bayesian developmental model that was able to prefer passivization for the five verb profiles that five-year-old English-speaking children comprehend the passive for, when the model was given a realistic sample of English child-directed speech to learn from. Importantly, because the Bayesian model incorporates both likelihood and prior information, I was able to not only formalize how children harness the information available in their input but also to quantify how costly English-speaking five-year-olds would view the passive structure to be, in the form of a prior on passivization.

5.7.1 Interpreting the Passivization Prior

How exactly can we interpret the estimates on the passivization prior? I reiterate that this prior on the passive structure can include both the child’s prior knowledge about which verbs are passivizable and the passive structure itself, as well as the child’s ability to deploy that passivization knowledge in real time during an experiment. Given this, a

plausible assumption could be that the perceived cost of the passive structure is fixed – that is, the *a priori* passive structure cost does not vary by verb or verb class.⁷⁰ With this in mind, the highest minimum prior can be viewed as an estimate of the perceived cost because that cost is the *least* it could be and still allow five-year-olds to generate the correct passivization behavior for all five profiles. Looking at the model that is only heeding TRANSITIVITY+OBJECT-EXPERIENCER in Table 5.7, the minimum prior that would be able to passivize a verb in all five lexical profiles is 0.44. Because this prior is the minimum, any prior that is below this number would not be able to meet the passivization threshold for that profile. This means that even through a prior of 0.21 would be able to passivize Profile 2, it would be unable to passivize Profiles 1, 3, 4, and 5. A prior of 0.44, in contrast, would be able to passivize Profile 2 because this prior is greater than 0.21.

For the two successful models in Table 5.7, the minimum priors yield an estimate of 0.43-0.44 which is noticeably not much below 0.50. This suggests that by five years old, English-speaking children would not *a priori* view the passive as that expensive a structural option. This is because although I make the assumption that passivization should be more costly than not (hence, the prior should be less than 0.50), the minimum priors yielded in these successful models could have been anywhere between 0 and 0.50. A minimum prior closer to 0 would have meant that passivization was extremely costly for children. So because the successful models in this study had minimum priors of 0.43-0.44, I have interpreted this to mean that passivization is costly but not excessively so.

5.7.2 Predictions and Consequences

There are several open questions that these results raise. First, while the present model assumes that the verb features are independent from each other, it might be that these features are correlated to each other or the set of features might be reducible to a different

⁷⁰If, however, there is reason to believe that the cost of the passive did vary by verb or verb class, perhaps because children's input experience strongly determined which verbs they even considered passivizable, then the model could be modified to allow for multiple passive priors.

set. We might then wonder how the relationship between the lexical features could impact the developmental model, as the likelihood calculation would change, on the basis of these correlations or feature reduction. In particular, if the features are not independent, we would not calculate the likelihood by multiplying their independent likelihoods (e.g., $p(\text{ACTIONAL}=1|+\text{pass}) * p(\text{AGT-PAT}=1|+\text{pass})$). Instead, we would need to calculate joint likelihoods for correlated features (e.g. $p(\text{ACTIONAL}=1, \text{AGT-PAT}=1 | +\text{pass})$).

Given the current results however, these correlations seem unlikely to impact the qualitative results I found related to the features five-year-olds would need to attend to versus ignore. In particular, I would predict that if features are in fact correlated, they should either both be attended to or both be ignored by children. I found only two filters that are predicted to lead to five-year-old passivization behavior: attending to TRANS(ITIVITY) only, or attending to TRANS and OBJ(ECT)-EXP(ERIENCER). Therefore, on this model all the other features were ignored – so, even if any of these other features are in fact correlated, this would be irrelevant since they were all ignored. For the case where two features are attended to (TRANS+OBJ-EXP), it is possible that TRANS is correlated with OBJ-EXP; this seems less likely because TRANS is a syntactic feature while OBJ-EXP is a lexical semantic feature. However, if these two features were in fact correlated, then perhaps it is not surprising that the only two successful filters involved TRANS and TRANS+OBJ-EXP.

A second open question relates to the target state I assumed in this study: the five verb profiles that five-year-olds are thought to be able to passivize, on the basis of the synthesis of experimental studies from Chapter 2. To check whether these profiles actually are available to five-year-olds, I should evaluate five-year-old comprehension of other verbs in these profiles as well as their behavior on novel (i.e., nonsense or nonce) verbs are also in these profiles. If five-year-olds do understand other verbs in these five profiles, I have additional support that they represent the appropriate target knowledge in five-year-olds.

A third open question relates to the specific input filters discovered by the current de-

developmental modeling results for English-speaking five-year-olds. In particular, the developmental model suggests that five-year-olds must attend to TRANS to understand the passives that they do, and they may also attend to OBJ-EXP. This is a testable prediction for the features that five-year-olds should be sensitive to in a behavioral study involving verbs with and without these features. In particular, are five-year-olds particularly attentive to these features when deciding if a verb can be passivized? A novel verb learning task may be able to evaluate this and is the focus of the next chapter in this dissertation. The developmental model here allows us to make predictions about children's expected success for the different feature combinations (i.e., by calculating the posterior in Equation 5.3). I can compare these predictions against the behavioral results obtained from this experiment to see if either of the predicted input filters do indeed seem to be active in five-year-olds.

A fourth open question concerns the size of the hypothesis space that children are navigating through in order to learn the target adult grammar and how these hypotheses map onto possible human languages. As previously discussed, the hypothesis space that children are presumably navigating through is large given that we have attempted to narrow down the number of lexical features to this set of eight lexical features, i.e., 256 input filters for whether or not to heed a particular lexical feature. The hypothesis space is even bigger once we consider that after the input has been filtered based on these lexical features, the child then would have to learn whether the target adult grammar contains +FEATURE or -FEATURE. Barring any other external pressures that may reduce this hypothesis space (i.e., either from UG-related pressures or otherwise), the hypotheses that make up this space could in theory map onto possible grammars for humans. Future work is needed to address these possible external pressures and/or how children can efficiently navigate a large hypothesis space. Cross-linguistic variation could be used to a learning theory that constrains the child's navigation of her hypothesis space such that

some hypotheses are more likely than others.⁷¹ As previously noted in Chapter 2, Keenan and Dryer (1981) describes a set of one-way implicational relationships: (i) if a language has passives of STATIVE verbs (e.g., *lack*, *have*, etc.) then it has passives of verbs denoting events; (ii) if a language has passives of intransitive verbs, then it has passives of transitive verbs. Landau (2010) has also observed that there are some languages that systematically do not passivize +SUBJECT-EXPERIENCER verbs such as Irish and Scots Gaelic. Although this dissertation is focused on English verbal passives, the hypothesis space for children's development of input filters (i.e., which lexical features are heeded in order to arrive at the set of verbs that passivize in the target adult grammar) could be constrained to account for these cross-linguistic variations.

A fifth open questions concerns the modulation of the passivization prior. Because the passivization prior encompasses both children's structural representation of the passive as well as their ability to deploy this knowledge in real time during an experiment, it is conceivable that children's behavior may change when presented with experimental manipulations that may alleviate factors that could possibly hinder their ability to deploy their linguistic knowledge. For example, Deen et al. (2018) found that when the discourse context was manipulated such that the internal argument of the passive was topicalized, young children's accuracy on long –ACTIONAL passive sentences rose to a rate of 89%, compared to 55% in the baseline condition (where the context was kept neutral). Deen et al. also found that when the test sentence is repeated, young children's accuracy on long –ACTIONAL passive sentences also improved (a rate of 83.3%) compared to the baseline condition (i.e., only one instance of the test sentence). So while the likelihood probabilities that children are calculating from their linguistic input are presumed to be consistent regardless of experimental methodology, manipulations of the discourse topic in an experimental context or the number of times children are presented with the test sentence

⁷¹Some evidence that not all hypotheses in a hypothesis space have to manifest as actual natural languages comes from word order (<https://wals.info/feature/81A#2/18.0/153.1>) and suppletion (Bobaljik, 2012).

could be modulating the passivization prior such that children's ability to deploy their linguistic knowledge is facilitated leading to improved performance.

And lastly, while the focus of this study was on investigating the passivization behavior of five-year-old children, we can also apply the same methodology to modeling the passivization behavior of three- and four-year-old children. Given existing empirical data on familiar verb comprehension described in Chapter 2 and the analysis of child-directed speech to three- and four-year-old children described in Chapter 3, the developmental computational model can evaluate how input filters needed to model the passivization behavior of younger children differ from the five-year-olds and generate testable predictions of how younger children would comprehend familiar and novel verbs from certain lexical profiles in the passive.

5.8 Summary

To concretely investigate the possibility that it is changes to children's intake that causes the observed developmental asymmetry, I have described a developmental computational model that aimed to capture the developmental trajectory that we observed in children's behavior. An important contribution of this developmental modeling approach is that it provides a way to be explicit about (i) how children use the input available to them when comprehending the passive, and (ii) how costly children perceive the passive structure to be. In particular, I can define what children's selective attention could look like with respect to lexical features and the cost that the passive structure could have for five-year-olds. This work underscores the utility of developmental modeling for researchers concerned with both representations and the acquisition process. Through an empirically grounded mathematical model of English-speaking children's acquisition of the passive, I have specified a theory that incorporates both the learning process and the representations involved in that learning process, as well as provided promising future directions for a more complete understanding of the developmental trajectory.

The results of the computational models that were successful at capturing five-year-old children's passivization behavior suggest that if input to five-year-old children were restricted to the TRANSITIVITY and OBJECT-EXPERIENCER features, then children's behavior would match the observed developmental trajectory, i.e., five-year-old children would successfully comprehend the passive of novel verbs from Profiles 1-5. I test these predictions in a behavioral study where I provided participants with linguistic input that is restricted to these lexical features while teaching them novel verbs from particular lexical profiles. I will describe this study and its results in the next Chapter.

6 | Relying on Lexical Features to Classify Novel Passivizable Verbs⁷²

6.1 Introduction

The results of the computational developmental model in the previous chapter suggest that (i) children may not be harnessing all of the lexical information available to them in the input; and (ii) children may be attending to specific features in order to successfully arrive at the proper classification for passivizable verbs by age five. In this chapter, I aim to assess the predictions of the computational model by evaluating children's comprehension of novel (i.e., nonsense or nonce) verbs in the passive form. I am assuming that passivization is a classification that applies to classes of verbs that are defined by lexical features. So, a verb class defined by some set of lexical feature values (e.g., TRANSITIVITY and TRANSITIVITY+OBJECT-EXPERIENCER) can either be classified as +pass or not (-pass). But if the verb class is classified as +pass, then any new member (i.e., verb) of the class should also inherit the +pass classification and be passivizable. In contrast, if the class is -pass, then new members of the class would not inherit a passivizability classification.

In the behavioral study that I present in this chapter, I tested the features highlighted by the two computational models that were successful at characterizing a five-year-olds passive behavior, namely TRANSITIVITY and (STATIVE) OBJECT-EXPERIENCER. These computational models make the prediction that if input to five-year-old children were re-

⁷²The behavioral study in this chapter has been presented at BUCLD45 as part of a collaboration with Letitia Naigles. I'd like to extend special thanks to Renato Lacerda for being the voice of Batson the alien, Jinman Jiang and Coral Olmeda for being wonderful alien interlocutors, and Sarah Deangelo and Shuyan Wang for assisting in data collection.

stricted to these two lexical features, then children's behavior would match the observed developmental trajectory, i.e., five-year-old children would successfully comprehend the passive of novel verbs from Profiles 1-5. Because the LEXICAL SEMANTIC PROFILE HYPOTHESIS predicts successively larger subsets of these five lexical profiles (such that older children comprehend passives of verbs from more lexical profiles than younger children), children older than 5 would also be able to comprehend passives from all five lexical profiles. For children younger than 5, because the computational model is only a model of a five-year-old child's passivization behavior, it makes no prediction for how these younger children should perform.

Although the computational model does not predict lexical features outside of TRANSITIVITY and (STATIVE) OBJECT-EXPERIENCER to matter, I also tested the additional lexical semantic feature AFFECTEDNESS in this behavioral study. This is because while most studies tended to focus on children's behavior on real and familiar verbs in the passive, [Pinker et al. \(1987\)](#) actually tested English-speaking children's comprehension of novel verbs in the passive form and found that AFFECTEDNESS is a lexical semantic distinction that impacted children's performance on the passive (see Chapter 2 for more details of this account). It is an empirical question whether the results of [Pinker et al. \(1987\)](#) would generalize to the present behavioral study. In their study, [Pinker et al. \(1987\)](#) found that three- to five-year-old children were less willing to allow passivization of novel verbs when the logical object was unaffected. Since [Gordon and Chafetz \(1990\)](#) found that children can represent a stationary entity as a main affected object if it undergoes a state change, I used this definition to define whether an object was (un-)affected.

From an empirical standpoint, it is unclear how children should behave with regards to novel verbs formed from these five lexical profiles outside of the studies conducted by [Pinker et al. \(1987\)](#). But if the assumption that new members of a verb class should inherit any passivization classification (as mentioned above), then these lexical features should be highly predictive of children's performance on the passive forms of these novel

verbs. Specifically, when presented with linguistic input that is restricted to a particular set of lexical features, five-year-old children are predicted to exhibit a similar pattern of performance as they did in the Truth Value Judgment Task described in Chapter 4. Specifically, that children are predicted to be successful at comprehending the passives of all verb classes except for SUBJECT-EXPERIENCERS. If, however, Pinker's (1989) "Affectedness Constraint" holds (that children's performance is impacted by whether the object of the passive undergoes a state/location change), then children's performance should pattern accordingly such that five-year-old children should be less likely to comprehend the passive of a -AFFECTED verb.

6.2 Experiment

I aim to assess if English-speaking children can reliably comprehend nonce verbs in the passive given a tightly controlled input as predicted by the developmental computational model described in Chapter 5 in addition to predictions of Pinker's (1989) "Affectedness Constraint".

6.2.1 Participants

The experiment described below was tested with 66 children (4;01-13;02, mean age=7;10) recruited from Connecticut daycares, the Connecticut Science Center, and families from the UConn KIDS database. Nine children were excluded from the final data analysis in cases where they did not exhibit competence in the task during the training phase. The Results section reflects data collected from 57 children (4;01-13;02, mean age=8;03). Although the child participants' ages ranged from 4 to 13 years, there are three age groups of interest based on the predictions of the developmental computational model from Chapter 5: (i) five-year-old children, (ii) children younger than five, and (iii) children older than five. Thus, the participant breakdown by age group is shown below in Table 6.1.

As adult controls, 36 undergraduate students were recruited from the University of

Table 6.1: Number of participants and mean age of the child participants broken down into three age groups.

Age Group	# of Participants	Mean Age
four-year-olds	5	4;08
five-year-olds	8	5;06
older than five years	44	9;01

Connecticut Department of Linguistics Participant Pool. Three adults were excluded from the final data analysis for failing on the filler control items. The Results section thus reflects data collected from 33 adults. All participants were native speakers of US English.

6.2.2 Method

The methodology used in the present study is a combination of a novel-verb learning task, a picture-selection task, and a grammaticality judgment task. After learning the meaning of a novel (i.e., nonce) verb, participants were asked to apply that knowledge to a picture-selection task where they had to choose the picture that matched the test utterance. Participants were also asked to indicate if they thought the test utterance was unacceptable by choosing a picture containing a red \otimes . This option for unacceptability allowed participants an additional choice whenever they encountered a verb that they could not comprehend in the passive. Most behavioral studies investigating children's behavior on the verbal passive often give participants two choices, either the passive interpretation of the verb or the active interpretation. In these studies, if it was the case that participants were sure that a verb was incompatible with the passive interpretation, they would have no choice but to choose the only remaining option, which is the one that corresponds to the active interpretation of the verb. By adding the option of the red \otimes , we may be able to observe how participants behave when they fail to comprehend a novel verb in the passive. Specifically, in the case where participants reject the passive of a novel verb, do they assume that the test utterance is unacceptable (and thus choose last picture containing the \otimes) or do they default to choosing the picture that corresponds to the active interpretation

of the verb.

6.2.2.1 Procedure

This task was carried out by a single experimenter using a laptop computer displaying animated clipart and video clips in Microsoft PowerPoint. All participants went through a training phase (with corrective feedback) in order to familiarize them with the task before moving on to the test phase.

Training Phase. Participants were told that an alien named “Batson” was going to teach them new words in “alien-speak” by showing them a short video clip and some cartoon animations. They were then introduced to a picture-selection task where they needed to select which of the three pictures presented to them best matched the alien’s utterance. As shown in Figure 6.1, the first two pictures always showed real scenes while the third picture was crossed out with a red \otimes . Participants were told that the alien sometimes liked to play pranks by saying sentences that “don’t quite sound like something [the participant or the experimenter, a native English speaker] would say”. They were instructed to choose the third picture (containing the red \otimes) whenever the alien is playing such a prank as shown in Figure 6.2. All training items where participants were supposed to choose the red \otimes were test sentences that contained a subject-verb agreement error (e.g., **The dog have chasing the cat*). This forced participants to pay attention to the verbal morphology of the test sentences in order to decide whether the test sentence is acceptable in English. Errors in verbal morphology in the training phase most closely resembled comprehending a non-passivizable verb in the passive and thus serve as appropriate training for participants in this task. Participants are ultimately asked to make two decisions in the task: (i) whether the test utterance sounds acceptable in English; and (ii) if the test utterance sounds acceptable, which of the two cartoon panels match the test utterance.

Additionally, participants were told that the other aliens, besides Batson, were natu-

Figure 6.1: An example from the training phase where the target answer is the first picture from the left. Participants were always shown three pictures where the first two pictures depict real scenes and the third picture is always a red .

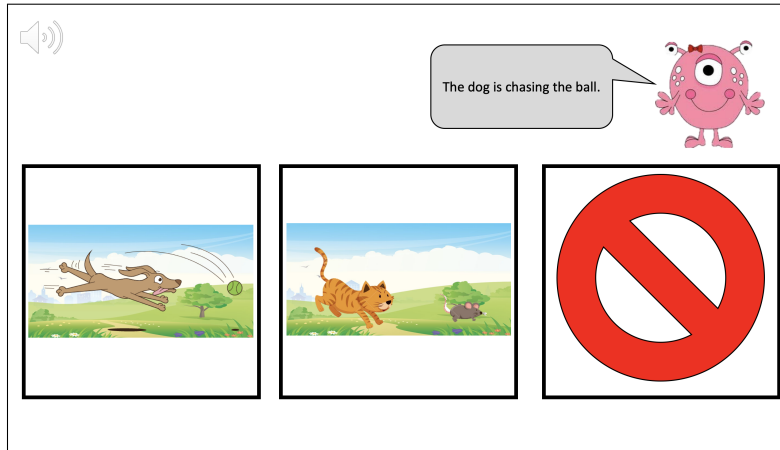

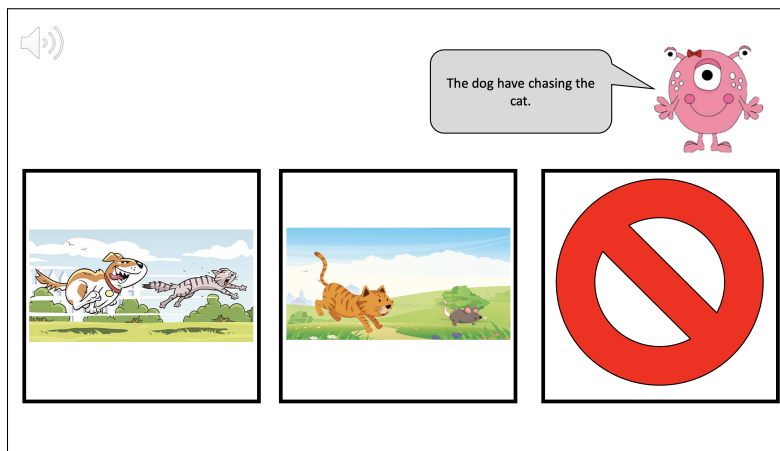

Figure 6.2: An example from the training phase where the target answer is the third picture from the left containing the red .



rally blue but that if these blue aliens had a feeling, they would appear as a different color externally to reflect their feelings as shown in Figure 6.3. Participants were not informed which feelings these colors correspond to and did not observe these aliens undergo a change in their coloring. This caveat allowed participants to be tested on novel stative psych verbs in a manner that was both as simplistic and as contrastive as the novel eventive verbs in this study.

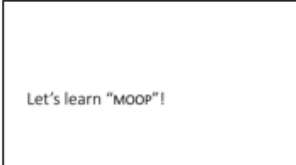

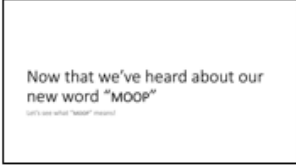



Figure 6.3: An example from the training phase where participants were introduced to aliens that would later appear in the experiment. Participants were told that these aliens were naturally blue (left) but could change colors externally depending on the feelings of their aliens (right).



Learning Phase & Testing Phase. Each verb was tested as a separate unit from each other and went through the same procedure: (1) video dialogue, (2) visual scenes, (3) test phase. First, when the participant was ready to learn a new verb, the participant watched a short conversation between two blue aliens where they got to hear the novel verb used in a linguistic context. [Yuan and Fisher \(2009\)](#) found that watching dialogues was effective in teaching two-year-old children syntactic information about a novel verb. Then, participants were shown visually what these verbs meant. They were shown two different instances of the visual context where this verb could be used felicitously.

After the Learning Phase, the Test Phase consisted of four test items where participants heard the test utterance from the alien and chose between three pictures each time. When this was done, the participant moved on to either the Learning Phase of the next novel or a filler control item. [Figure 6.4](#) shows the procedural order of the Learning and Test Phase for an example novel verb. In order to ease the participants into this elaborate task, for the first two verbs, participants received two actives and two passives as test sentences, whereas for the last three verbs they received one active and three passives as test sentences.

Figure 6.4: Procedure of an example novel verb, *moop*

Learning Phase	Introduction to the video dialogue	
	Video Dialogue	
	Introduction to the visual context	
	Visual Context 1	
	Visual Context 2	
Test Phase	Test Item 1 (Active)	
	Test Item 2 (Passive)	

6.2.2.2 Materials

Novel Verbs. Of the four lexical features of interest, TRANSITIVITY, STATIVITY, OBJECT-EXPERIENCER, and AFFECTEDNESS, five classes of novel verbs were created using combinations of these four features and two novel verbs were created from each class for a total of 10 novel verbs used in this study. I will refer to these verb classes that are specifically

tested for this study as the "(five) novel verb classes". Table 6.2 shows the lexical profiles of the 10 novel verbs used in the experiment. Table 6.3 shows the intended meanings of these 10 novel verbs.

Table 6.2: Lexical profiles of the 10 novel verbs as a combination of TRANSITIVITY (TRANS), STATIVITY (STAT), AFFECTEDNESS (AFFECT), and Object-Experiencer (OBJ-EXP) and close approximates of their semantic categories.

Novel Verbs	TRANS	STAT	AFFECT	OBJ-EXP	Close Linguistic Counterpart
<i>blick, moop</i>	+	+	+	+	≈ Object-Experiencers (ex. <i>frighten</i>)
<i>gorp, keat</i>	+	+	-	-	≈ Subject-Experiencers (ex. <i>love</i>)
<i>gump, pell</i>	+	-	+	-	≈ Eventive w/ Affected Object (ex. <i>hug</i>)
<i>doak, pilk</i>	+	-	-	-	≈ Eventive w/o Affected Object (ex. <i>block</i>)
<i>floose, jape</i>	-	-	-	-	≈ InTransitive (ex. <i>fall</i>)

Table 6.3: The meanings of the 10 novel verbs taught to participants along with their close linguistic counterparts

Novel Verb	Meaning in the Experiment	Close Linguistic Counterpart
<i>blick</i>	Subject is blue, Object is orange	≈ Object-Experiencers
<i>moop</i>	Subject is blue, Object is purple	≈ Object-Experiencers
<i>gorp</i>	Subject is green, Object is blue	≈ Subject-Experiencers
<i>keat</i>	Subject is yellow, Object is blue	≈ Subject-Experiencers
<i>pell</i>	Subject causes Object to spin	≈ Eventive w/ Affected Object
<i>gump</i>	Subject causes Object to grow	≈ Eventive w/ Affected Object
<i>doak</i>	Subject moves in front of Object	≈ Eventive w/o Affected Object
<i>pilk</i>	Subject jumps over Object	≈ Eventive w/o Affected Object
<i>floose</i>	Subject pulsates	≈ InTransitive
<i>jape</i>	Subject teeters	≈ InTransitive
<i>lup</i>	Subject falls sideways	≈ InTransitive

Video Dialogue For each novel verb taught, video recordings were made of two “alien girls” talking to one another. Two women, whose faces were painted blue to simulate them being aliens, were depicted conversing with each other. The goal of the video dialogue was to provide participants with some linguistic evidence of the novel verb’s lexical features. Tables 3-11 shows example dialogues for each of the five novel verb classes.⁷³

Table 6.4: Example script of audio for *doak* (+TRANS, -STATIVE, -AFFECT)

Talker 1	Starting Question	Did you hear?
	(In-) Transitive + (Non-) Stative Frame	Andrew is doaking Mary. He is doaking Mary but nothing happens to her.
	Emphasis on Obj/Subj	Look what Andrew does!
Talker 2	In-Agreement	Oh yeah!
	Emphasis on Obj/Subj	Lucky Mary!
	(In-) Transitive + (Non-) Stative Frame	He is doaking Mary. It's cool when Andrew is doaking Mary.

Table 6.5: Example script of audio for *pell* (+TRANS, -STATIVE, +AFFECT)

Talker 1	Starting Question	Did you hear?
	(In-) Transitive + (Non-) Stative Frame	Andrew is pelling Mary. He is pelling Mary and watch her go.
	Emphasis on Obj/Subj	Just look at Mary!
Talker 2	In-Agreement	Oh yeah!
	Emphasis on Obj/Subj	Lucky Mary!
	(In-) Transitive + (Non-) Stative Frame	He is pelling Mary. When he is pelling Mary, watch her go!

Table 6.6: Example script of audio for *blick* (+TRANS, +STATIVE, +AFFECT)

Talker 1	Starting Question	Did you hear?
	(In-) Transitive + (Non-) Stative Frame	Andrew blicks Mary. He blicks Mary and she feels it.
	Emphasis on Obj/Subj	Just look at Mary!
Talker 2	In-Agreement	Oh yeah!
	Emphasis on Obj/Subj	Lucky Mary!
	(In-) Transitive + (Non-) Stative Frame	He blicks Mary. And ooh, Mary feels it when Andrew blicks her.

-STATIVE verbs were always presented as observable animations (i.e. movement occurred onscreen). On the other hand, +STATIVE verbs were always presented as still images where one of the two characters mentioned was a non-blue color, which was meant to indicate to participants that the non-blue character was experiencing a feeling without showing the change onscreen. This was done to avoid accidentally teaching participants that these +STATIVE verbs were eventive.

⁷³See [Appendix A.5](#) for the video dialogue for all 10 novel verbs.

Table 6.7: Example script of audio for *gorp* (+TRANS, +STATIVE, -AFFECT)

Talker 1	Starting Question	Did you hear?
	(In-) Transitive + (Non-) Stative Frame	Andrew gorps Mary. Andrew gorps her and he feels it.
	Emphasis on Obj/Subj	Just look at Andrew!
Talker 2	In-Agreement	Oh yeah!
	Emphasis on Obj/Subj	Lucky Andrew!
	(In-) Transitive + (Non-) Stative Frame	Andrew gorps her. And oooooh, Andrew feels it when he gorps Mary.

Table 6.8: Example script of audio for *floose* (-TRANS, -STATIVE, +AFFECT)

Talker 1	Starting Question	Did you hear?
	(In-) Transitive + (Non-) Stative Frame	Andrew is floosing. No matter where he goes, Andrew is floosing.
	Emphasis on Obj/Subj	Just Look what Andrew does!
Talker 2	In-Agreement	Oh yeah!
	Emphasis on Obj/Subj	I saw Andrew floosing yesterday!
	(In-) Transitive + (Non-) Stative Frame	When Andrew is by himself, he is floosing the most. Watch Andrew go!

Materials for the –TRANSITIVE novel verbs were constructed to be similar to the +TRANSITIVE verbs. Table 11 shows an example of the audio dialogue that participants were presented with during the Learning Phase. The visual contexts always showed one character on-screen performing the intended action (e.g., only John is present for *John is floosing*.) Figure 6.5 shows an example of a test item for the –TRANSITIVE verb, *floose*. Because participants were tested on –TRANSITIVE verbs in the passive (which would involve explicitly naming two characters) and the test items were create to be as similar as possible regardless of TRANSITIVITY, the test items for the –TRANSITIVE verbs depict both mentioned characters in each of the two pictures. These two characters do not interact with each other, rather one character appears to be standing in the corner while the other character is in the center performing the intended action. So for Figure 6.5 below, the first picture on the left depicts Henry pulsating while Sara stands by and the second picture in the middle depicts Sara pulsating while Henry stands by. But while the expected answer for a

-TRANSITIVE verb in the passive should be the third picture (which contains the red ⚡), it is conceivable that participants may try to interpret the preposition *by* in the passive as a locative preposition. Thus, participants may incorrectly interpret “Henry was floosed by Sara” as “Henry was floosing by Sara” and choose the picture that corresponds to Henry pulsating near Sara (the first picture on the left in Figure 6.5). I refer to this type of answer in the -TRANSITIVE verb condition as the “LocativeBy” answer.

Figure 6.5: An example of a test item in the *floose* condition.

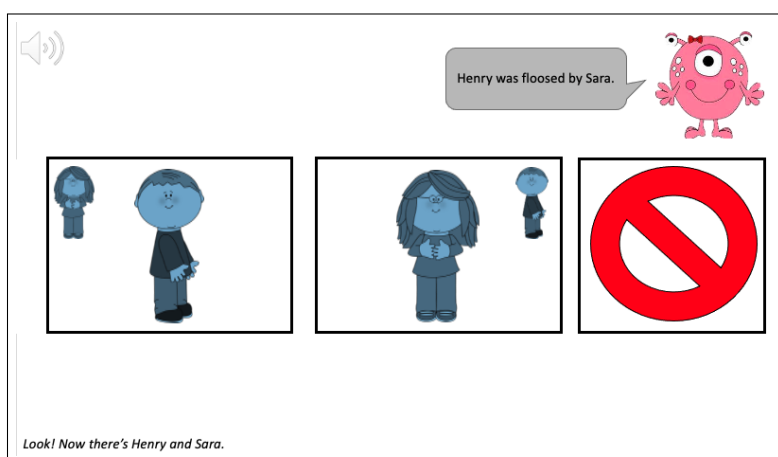

The 10 novel verbs were distributed pseudo-randomly across four lists such that, in each list, participants received five novel verbs, one from each novel verb class. During the Test Phase, each test item consisted of three pictures shown side-by-side onscreen as exemplified in Figure 6.6. Starting from the left, the first and second pictures depicted mirrored instances of the intended meaning of the novel verb.

So if *moop* meant that the subject is blue and the object is purple, hence an OBJECT-EXPERIENCER verb, then a test item for that condition would have one character be purple in one picture, and the opposite character be purple in the other picture. The last, third picture, is always shown as a red ⚡. Test sentences were presented to participants through pre-recorded audio clips spoken by a non-native English speaker, a male native speaker of Brazilian Portuguese. The reason for choosing a non-native English was to avoid the

Figure 6.6: An example of a test item in the *moop* condition.

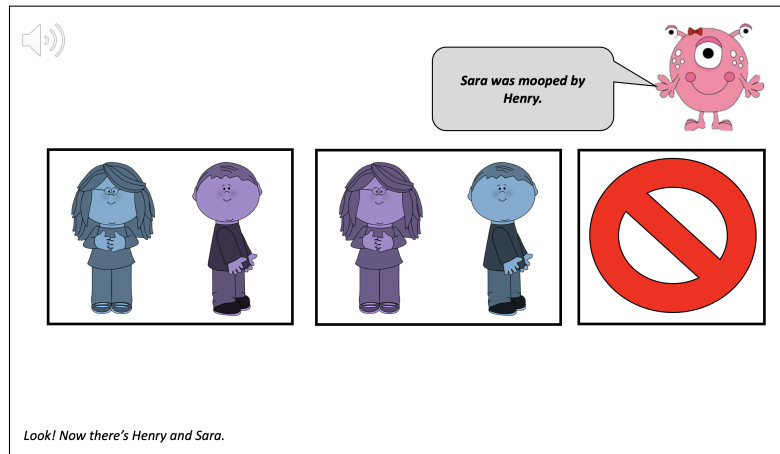

potential oddness of encountering a test sentence that is syntactically ungrammatical in English. Any perceivable non-native phonology in the recording of the test sentences did not correlate with participants' choice of the red \propto .

6.2.3 Results

Data from children were evaluated based on the age of the children broken down into three groups according to the predictions that could be made from the developmental computational model regarding children's passivization behavior: four-year-olds, five-year-olds, and children six years and older. Discussion of results will revolve around these three age groups and adults. For ease of exposition, I will refer to the five novel verb classes by their close linguistic counterpart described in Table 6.2.

Overall, participants were uniformly accurate on the active test sentences (84-98%). This suggests that child and adult participants were able to follow the complicated procedure and gained enough from the linguistic input to accurately apply their knowledge of these novel verbs in the active sentences.

I will first discuss participants' performance on the +TRANSITIVE novel verb classes (i.e., Eventives with Affected Object, Eventives with Unaffected Object, Object-Experiencers,

and Subject-Experiencers) before turning to participants' performance on -TRANSITIVE novel verbs. Starting with the adult data shown in Figure 6.7, adults performed better on Eventives (with Affected and Unaffected Objects) than Object-Experiencers ($W = 130, p = .0078$). Subject-Experiencers elicited the poorest performances, significantly below those of Object-Experiencers ($W = 170, p = .0078$) and Eventives ($W = 198, p = .0001$).

Figure 6.7: Percentage of Correct Responses by verb class: Adults (Since red \emptyset was never chosen, chance is set at 50%)

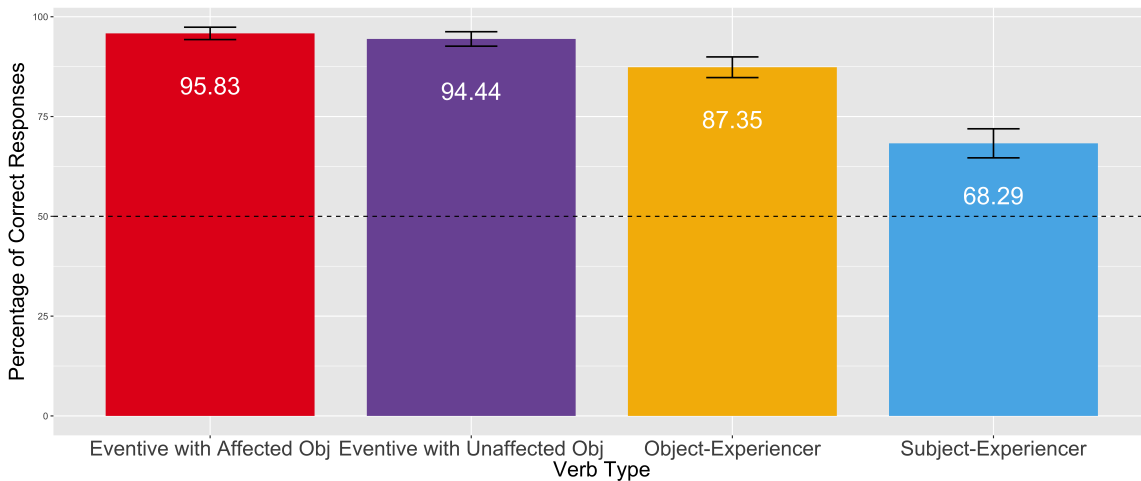
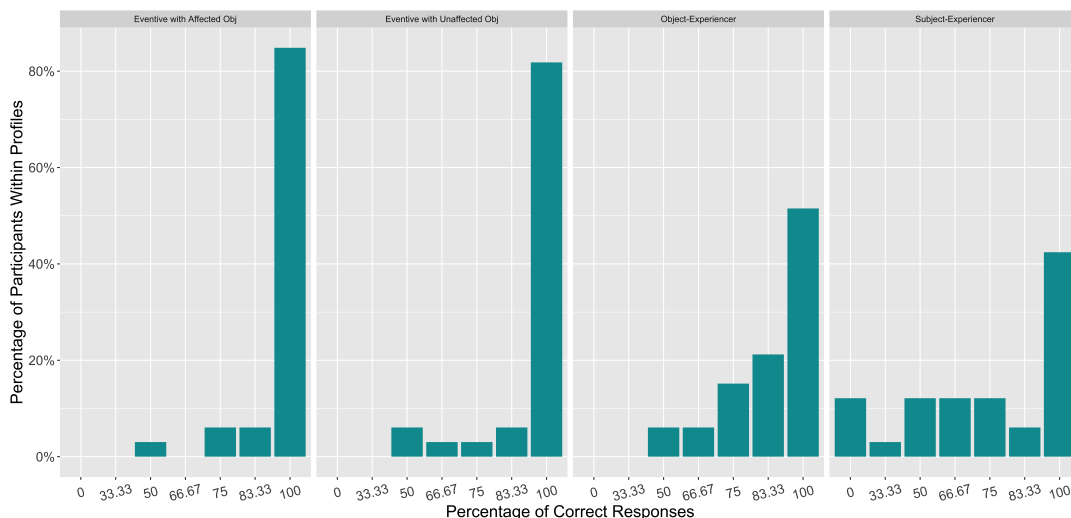

Figure 6.8 shows the distribution of accuracy rates for the adult participants broken down by the four +TRANSITIVE novel verb classes. So for example, for the Eventive with Affected Object verbs, 85% of adults were correct 100% of the time, 6% were correct 83% of the time, 6% were correct 75% of the time, and 3% of the adults were correct 50% of the time. This means that 28 out of 33 adult participants answered all of the test items correctly, two participants answered five out of the six test items correctly, two participants answered three out of four test items correctly, and one participant answered two out of four items correctly. Adults in this experiment received all 10 novel verbs and thus the number of passive test items that they could receive for any one novel verb could either be four or six (see Section 6.2.2.1). The spread of accuracy rates for adult participants especially for the novel OBJECT- and SUBJECT-Experiencer verbs suggests that adults were not giving answers that were based on a consistent strategy (e.g., always choosing the picture

that represented the active interpretation or the picture that represented the correct passive interpretation). Given that participants were presented these test items successively, the inconsistency of answer choices further supports that adults were guessing in these conditions.

Figure 6.8: Distribution of Accuracy Rates of the four TRANSITIVE Novel Verb Classes for adult participants (N=33).



Turning over to the child participants, when we look at how often children choose the third picture containing the red \otimes for the four TRANSITIVE novel verb classes, we see that children rarely judged passives of a TRANSITIVE novel verb to be ungrammatical. Thus, for the following analyses of children’s performance on these novel verbs, chance performance is set at 50% rather than 33% because participants are assumed to be mostly choosing between two pictures when they are asked to comprehend a PASSIVE of a TRANSITIVE novel verb.

Overall performance by the three age groups is shown in Figure 6.10. To see whether the responses were consistent within each child participant, Figures 6.11 - 6.13 show the distribution of responses for each age group broken down by the four +TRANSITIVE novel verb classes. So for example, in Figure 6.11, there were five four-year-old child participants. 80% of the children answered all of the test items in the Eventive with Affected

Figure 6.9: Distribution of Answer Types for the Transitive Novel Verb Classes for all child participants (N=57).

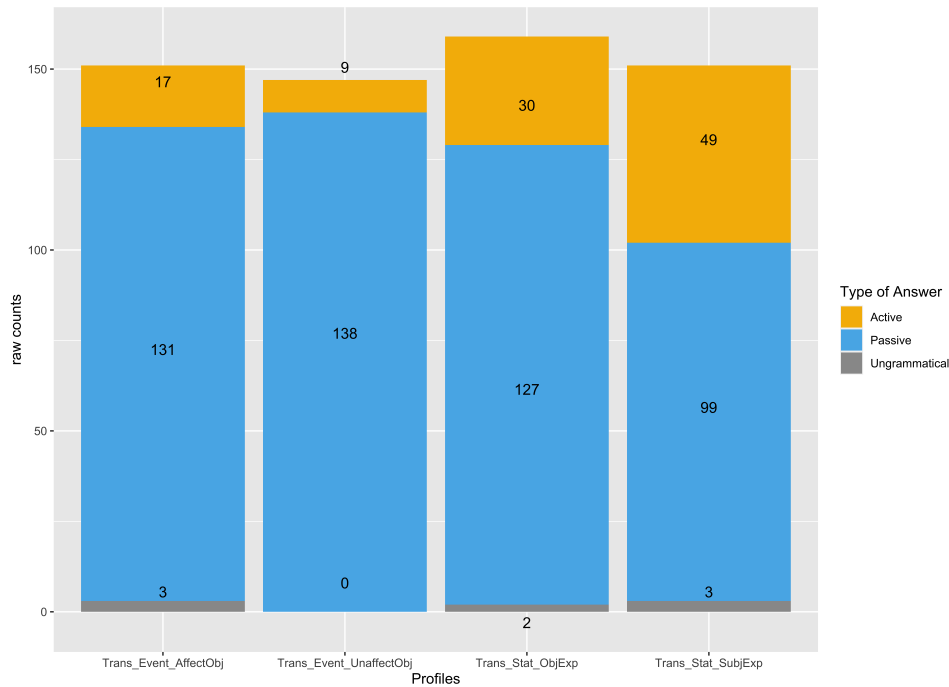

Object condition correctly and 20% of the children were correct 33.33% of the time. Since participants could have received either two or three passive test items per condition depending on the list (see Section 6.2.2.1), this means that one child got one out of three test items correct and four children got all test items correct (which can either mean two out of two or three out of three items correct).

The particular comparisons that we are primarily concerned with are discussed in the following sections.

6.2.3.1 Are Child Participants Successful Across All Verb Classes?

Children’s performance for each of the four +TRANSITIVE novel verb classes is shown in Table 6.9. Compared to chance at 50%, most of the child participants were successful across all verb classes. The exceptions would be the Subject-Experiencer class for the four- and five-year-olds and the Eventives with Affected Object class for the five-year-old children, where performance was not significant from chance.

Figure 6.10: Percentage of Correct Responses by verb class: Children (Since red ○ was almost never chosen, chance is set at 50%)

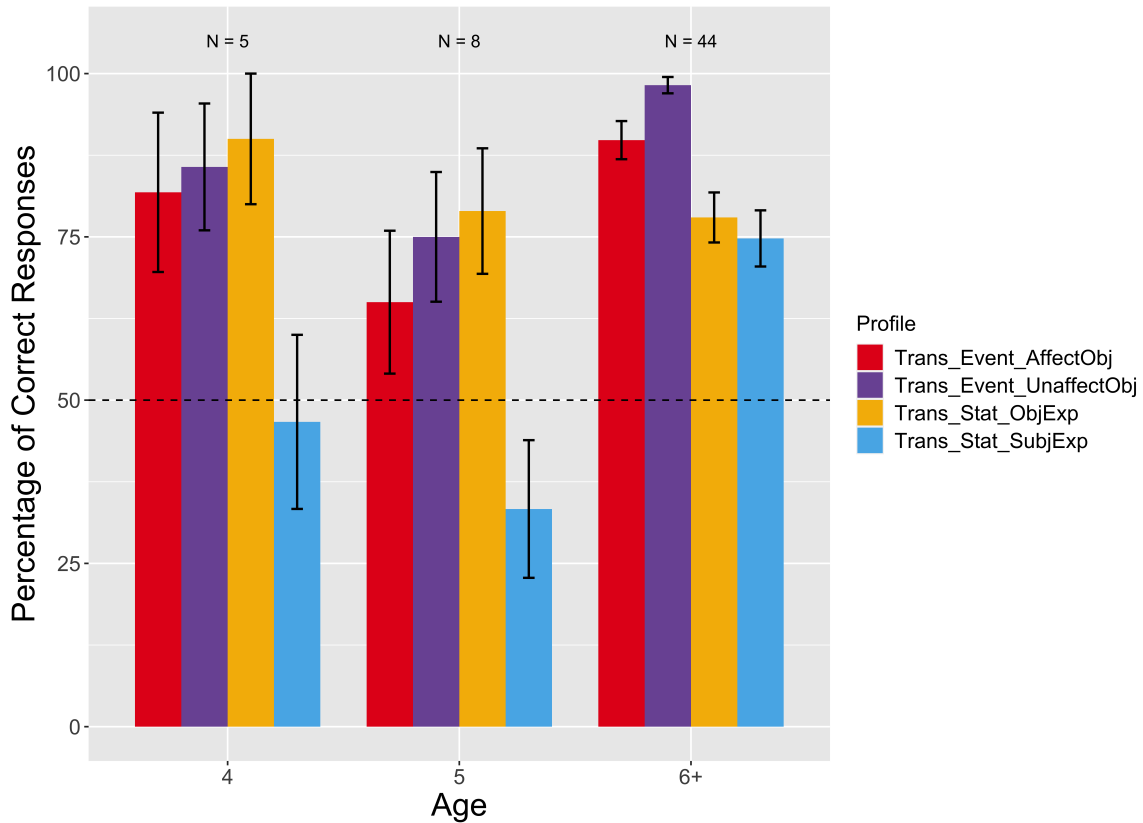
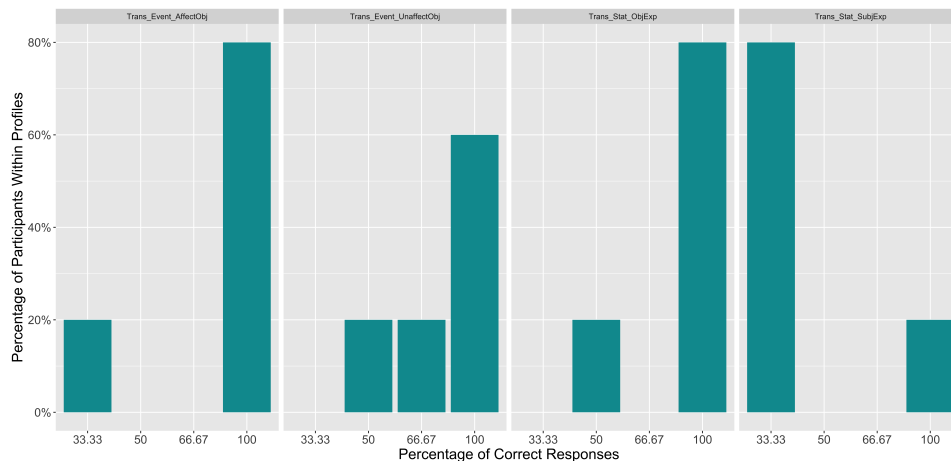

Figure 6.11: Percentage of correct responses by 4-year-old participants (N=5) broken down by novel verb class.



Because the sample size for four- and five-year-old children is so low (five and eight participants, respectively), I was unable to appropriately compare children’s performance

Figure 6.12: Percentage of correct responses by 5-year-old participants (N=8) broken down by novel verb class.

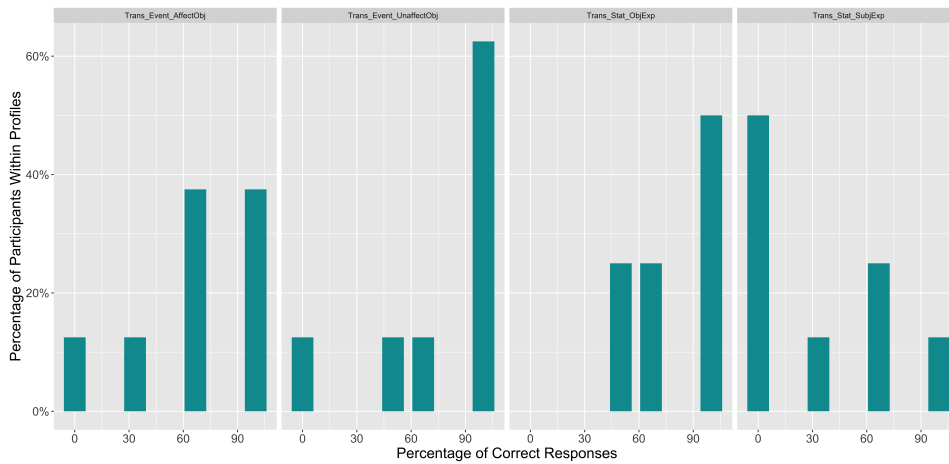
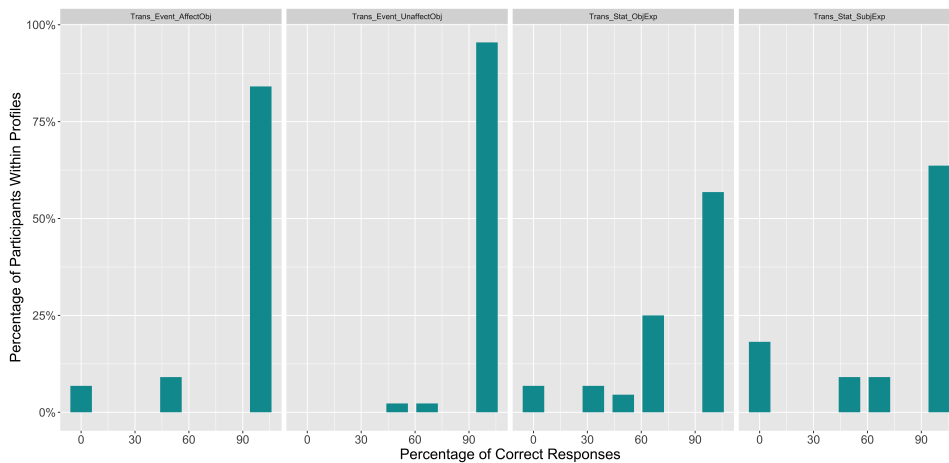

Figure 6.13: Percentage of correct responses by child participants 6 years and older (N=44) broken down by novel verb class.



on the novel verb classes to each other. In the following section, I describe statistical analyses of all 57 child participants, collapsing across all three age groups.

6.2.3.2 Affected vs Unaffected?

According to [Pinker et al.'s \(1987\) "Affectedness Constraint"](#), child participants are predicted to be less successful at allowing passivization of -AFFECTED novel verbs than +AFFECTED verbs. I thus compared children's performance on Eventives with Unaffected Object and Subject-Experiencers to Eventives with Affected Object and Object-Experiencers.

Table 6.9: Performance by each age group for each verb class as compared to chance (50%).

Transitive Novel Verb Class	% correct	<i>t</i>	<i>df</i>	<i>p</i>
Four-year-olds				
Eventives with Affected Object	81.82%	2.7509	4	<.05
Eventives with Unaffected Object	85.71%	3.1622	4	<.05
Stative Object-Experiencer	90%	4	4	<. 01
Stative Subject-Experiencer	46.67%	-0.2498	4	ns
Five-year-olds				
Eventives with Affected Object	65%	1.323	7	ns
Eventives with Unaffected Object	75%	2.0895	7	<.05
Stative Object-Experiencer	78.95%	3.566	7	<. 01
Stative Subject-Experiencer	33.33%	-1.1831	7	ns
Six-year-olds and older				
Eventives with Affected Object	89.81%	9.0704	43	<.0001
Eventives with Unaffected Object	98.23%	35.637	43	<.0001
Stative Object-Experiencer	77.97%	6.1469	43	<.0001
Stative Subject-Experiencer	74.76%	4.1295	43	<.0001

Children’s behavior across all age groups did not differ between –AFFECTED and +AFFECTED novel verbs ($W = 93$, $P = .48$ by Wilcoxon Signed-Ranked Test).

6.2.3.3 Are Stative verbs different from Eventive verbs?

For the Truth Value Judgment Task described in Chapter 4, child participants were observed to successfully comprehend Object-Experiencer verbs (which is a Profile 2 verb and a –ACTIONAL verb) in the passive despite predictions by Maratsos et al.’s (1985) ACTIONALITY distinction, which would predict difficulty with passives of –ACTIONAL verb. When children were taught novel Object-Experiencer verbs, their performance on these verbs in the passive form did differ from novel Eventive verbs such that children were better on passives of novel Eventive verbs than passives of novel Object-Experiencers ($W = 224$, $P = .03$ by Wilcoxon Signed-Ranked Test). In the same Truth Value Judgment Task, child participants were also observed to have more difficulty with passives of known Subject-Experiencer verbs (i.e., Profile 5 verbs). Thus, if children’s behavior with passives of novel verbs resembled their behavior with familiar verbs, then children are predicted

to have more difficulty with passives of novel Subject-Experiencers than passives of Eventive verbs. This prediction is born out as children were more successful on novel Eventive verbs than on novel Subject-Experiencers ($W = 435$, $P = .0001$ by Wilcoxon Signed-Ranked Test).

6.2.3.4 Non-passivization of –TRANSITIVE verbs

Child participants were overall not accurate in their performance on passives of the –TRANSITIVE novel verbs. Their percentage of accurate responses was 22%, which meant that children were not consistently choosing the third picture (containing the red \emptyset) whenever they encountered a passive of a –TRANSITIVE novel verb. Figure 6.14 shows the distribution of answer types for this condition. But although they were not accurate in consistently choosing the the picture denoting ungrammaticality, they did choose this third picture at a higher rate than with the +TRANSITIVE novel verbs. This suggests that there are some generalizations that are in place that classify –TRANSITIVE as having a –pass feature. When children were unwilling to judge the passives of –TRANSITIVE novel verbs as ungrammatical, they were disproportionately choosing the LocativeBy answer (i.e., the answer where the preposition *by* is interpreted as a locative).

6.3 Discussion

As mentioned in the previous section, because the sample size is very low for the four- and five-year-old participant groups, I was not able to perform pair-wise comparisons to assess young children’s passivization behavior for the five novel verb classes. Future work should expand on these sample sizes in order to assess how young children’s performance matches the predictions of the computational model. The following is a discussion of the results from the younger and older children as well as the adult participants assuming that these results hold up with a larger sample size.

Although the developmental computational model did not make any predictions for

Figure 6.14: Distribution of answer types for the –TRANSITIVE novel verb classes for all child participants (N=57).

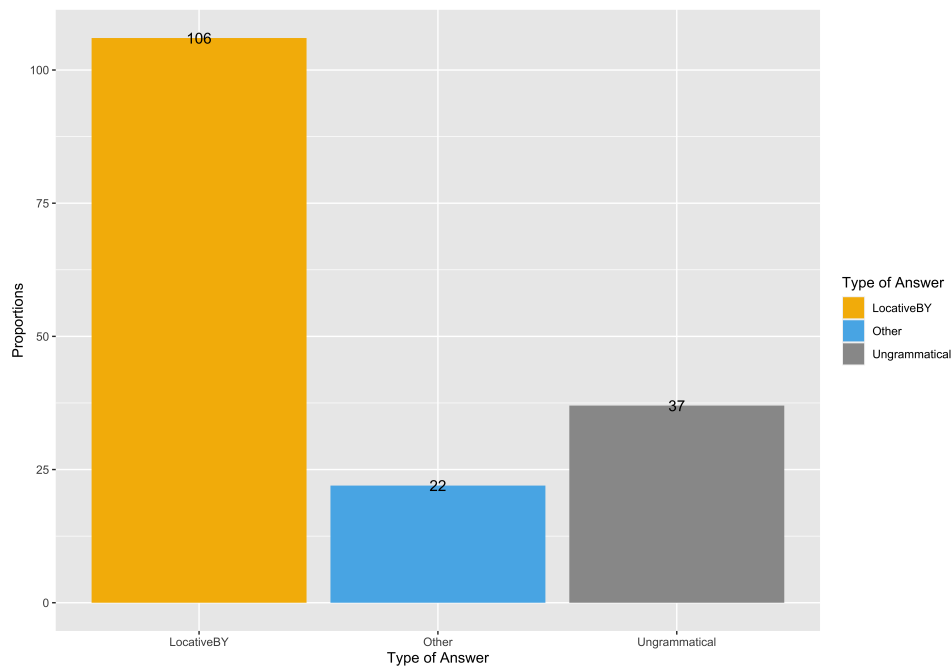

how four-year-old children should behave, they were significantly above chance for all of the +TRANSITIVE novel verbs except for the novel Subject-Experiencers. These results would be in line with the empirical results from the Truth Value Judgment Task from Chapter 4. However, for the five-year-old children, the computational model generated the predictions that when the linguistic input is restricted to TRANSITIVE or TRANSITIVE + OBJECT-EXPERIENCER, the five-year-old children should succeed on the passives of all +TRANSITIVE novel verbs that were created for this study. These predictions were not borne out in the present behavioral study because five-year-old children’s performance was not significant from chance for the Eventive with Affected Object novel verbs nor the novel Subject-Experiencers verbs. When we look at the older children (ages 6 and up), we see that children’s performance was significantly above chance for all four TRANSITIVE novel verb classes. This is in line with the predictions of the model since the model predicts that children should succeed on all novel verb classes by age 5 and thus older children should be successful as well.

In this study, I additionally tested predictions of [Pinker et al.'s \(1987\)](#) “Affectedness Constraint” which suggests that children would be less successful at allowing passivization of –AFFECTED novel verbs than +AFFECTED verbs. I did not find a difference in children’s performance for the +AFFECTED verbs compared to the –AFFECTED verbs. If, however, [Pinker et al.'s \(1987\)](#) “Affectedness Constraint” is modified to not apply to Eventive verbs (and thus Eventives with an Affected Object and Eventives with an Unaffected Objects are treated as the same verb class), then it would be able to account the differences that we see in children’s performance for Object-Experiencer verbs compared to Subject-Experiencer verbs.⁷⁴

Turning over to the adult participants, they were predicted to perform similarly to the adults in the Truth Value Judgment Task described in Chapter 4, i.e., performance should have been at ceiling for the active and passive test items for all five novel verb classes. However, this was not the case for the adult participants in the present behavioral study. While adults were above chance in their performance on the Eventives with an Affected and Unaffected Object and Object-Experiencers, they were no different from chance with the Subject-Experiencers. For adults, this result is made even more surprising by their ceiling performance with these novel verbs in the active voice, which suggests that participants had learned enough about the verbs’ meanings to accurately interpret it in the active but not the passive for the novel Subject-Experiencers. So, while adults excelled at picking the correct picture for the Object-Experiencer condition, they were roughly at chance in the Subject-Experiencer condition. For example, for the novel Subject-Experiencer verb, *gorp*, when adults were presented with the passive test item “Sarah was gorped by Henry”, adults were equally likely to pick the correct picture where Henry is green and Sarah is blue and the incorrect picture in which Sarah is green and Henry is blue. The incorrect picture is compatible with either interpreting the passive of the novel Subject-Experiencer as if it were an Object-Experiencer (with an Affected ob-

⁷⁴See [Ambridge et al. \(2016\)](#) for grammaticality judgment and comprehension studies testing the predictions of [Pinker et al.](#); [Pinker's \(1987; 1989\)](#) “Affectedness Constraint” in adults.

ject) or interpreting the sentence as if it were an active sentence (i.e. taking the first NP as the character that changes colors). Because the difficulty that we observe in adults for the novel-verb learning study is not a difficulty that we observe in a behavioral study with familiar verbs (see Chapter 4), these results can be interpreted in two ways: either Subject-Experiencers as a class are not classified as passivizable and thus new members are not inheriting any passivizable classification (+pass) or the lexical features that adults are relying on in order to passivize novel verbs are not present in the restricted linguistic input presented to adult participants in this study (e.g., VOLITIONALITY). If it is the case that adults do not passivize Subject-Experiencers as a class, then their performance on familiar Subject-Experiencers can be viewed as learned exceptions from their input. As we have seen in Chapter 3 for the corpus analysis of child-directed speech, children do hear positive evidence (though rare) of passives of Subject-Experiencers. So children could be learning that Subject-Experiencers in their language do passivize on a verb-by-verb basis. If, however, it is the case that the restricted linguistic input given to adults was insufficient for adults to assess whether the verb class that they are learning matches the verb class that they do deem to be passivizable for Subject-Experiencers known in English, then changing the restrictions on the linguistic input may improve performance by adults.

6.4 Summary

The purpose of the behavioral study presented in this chapter was to test the predictions generated by the developmental computational model described in Chapter 5. Specifically, I tested whether linguistic input that has been restricted to two lexical features, TRANSITIVITY and OBJECT-EXPERIENCER, would be sufficient evidence for children and adults to comprehend novel verbs of specific lexical profiles in the passive. The assumption is that if certain verb classes are determined by children to be passivizable (i.e., have a +pass classification feature), then any new member of the verb class will also inherit the +pass feature and children would be able comprehend the verb in the passive. This

inheritance should occur for new class member regardless of whether the verb is a real verb in English or a novel (i.e. nonsense or nonce) one. In order to test these predictions, I designed a novel verb-learning study where children and adults were taught novel verbs from several lexical profiles by being presented with linguistic input that was restricted to a few lexical features. Because the sample sizes for the four- and five-year-old children were too small for a better understanding of their passivization behavior, I found that across all age groups, novel SUBJECT-EXPERIENCER verbs elicited the poorest performance. This poor performance was also observed in the adult participants, which is a surprising results considering adults do not exhibit the same difficulty with passives of familiar SUBJECT-EXPERIENCER verbs (e.g., *hate, love, remember, etc.*).

If it turns out that the predictions of the developmental computational model is not borne out when the sample sizes for the younger children are expanded, this would be evidence that the specific instantiation of the learning theory implemented in Chapter 5 does not represent a way in which the acquisition of the set of passivization verbs could proceed. Furthermore, the difficulty observed in adults on the novel SUBJECT-EXPERIENCER verbs but not on the familiar SUBJECT-EXPERIENCER verbs suggests that more research is needed in order to fully understand the target adult grammar, which is a crucial metric for evaluating future computational models. Apart from testing the predictions of the developmental computational model, the results of the novel verb-learning study expands the current empirical data that we have for observed passive lexical verb asymmetry to children's behavior on the passives of novel verbs. In addition to the studies conducted by [Pinker et al. \(1987\)](#), the methodology introduced in this chapter can be used to further investigate the lexical verb asymmetry and the impact of a tightly controlled linguistic input based on lexical features.

7 | Wrapping Up

7.1 Summary of Findings

The goal of this dissertation was to investigate how the English verbal passive would be learned if we assume that the evidence is sufficient in the child's environment as opposed to being insufficient. To accomplish this, I investigated the source of a well-documented developmental asymmetry (i.e., the *PASSIVE LEXICAL VERB ASYMMETRY*) through the lens of lexical semantic features. Through a synthesis of experimental studies described in Chapter 2 and a Truth Value Judgment Task described in Chapter 4 I confirmed as well as expanded upon the empirical data on children's linguistic behavior with regards to this lexical asymmetry. By looking at the source of this developmental asymmetry, I investigated whether the linguistic input to English-speaking children could be insufficient for learning which verbs passivize in English. In a corpus analysis of child-directed speech presented in Chapter 3, I found that some parts of this asymmetry can be explained by the input frequency of passives but only through the lens of lexical features. That is, the verbs that children seem to acquire the earliest for the passive share lexical features with the most frequent verbs that children hear in the passive. Furthermore, I found that children's input of the passive is relatively consistent over time, which suggests that the trajectory observed in children's behavior with regards to passives of verbs from different lexical semantic profiles must be the result of something internal to the child, and may be a result of developmental changes in children's intake (i.e., what part of the linguistic input is actually harnessed by children to acquire their grammar) rather than external changes in children's input.

The approach that I take for this dissertation where children's development of the pas-

sive is linked to internal changes in the child rather than external changes in the linguistic input is (broadly) similar in spirit to previous theoretical approaches that assume something is changing internally to children (Borer and Wexler, 1987; Hirsch and Wexler, 2006; Snyder and Hyams, 2015). However, these previous proposals have assumed that what is changing internally in the child is the innate structural representation of the passive, while I am assuming that it is children's intake of the linguistic input with respect to lexical features that is changing. Importantly, I assume for this dissertation that the structural knowledge of the passive is in place in young children.

The proposal that I present in this dissertation is similar in spirit to prior approaches that make reference to certain lexical semantic features being more impactful for English-speaking children's development of the passive (Maratsos et al., 1985; Pinker et al., 1987; Litter et al., 2015; Messenger et al., 2012); but instead of considering only one or two lexical features, I consider that verbs can be classified based on the combination of all of the proposed lexical semantic features, which I refer to as a verb's lexical semantic profile. Through the corpus analysis in Chapter 3, the Truth Value Judgement Task in Chapter 4, and the developmental computational model in Chapter 5, I present research that links hypotheses about the lexical features to the linguistic input and provide a concrete learning theory for how children might utilize lexical features in order to produce the developmental asymmetry that is observed for children. In Chapter 6, I tested the predictions of the developmental computational model in a novel verb-learning study where I assessed children and adult's passivization behavior of novel verbs when they were presented with a tightly-controlled linguistic input. The results from this behavioral study help to inform future computational models as well as expand upon the empirical data on children's passivization behavior.

Ultimately, I investigated how children might classify verbs as passivizable based on lexical features rather than relying on hearing the verb in the passive in their input. I have designed three studies that should help clarify the role of input in the acquisition of

passives. Below I briefly discuss implications for theoretical representations of the passive and the development of the passive in English, as well as avenues for future work.

7.2 Theoretical & Developmental Implications

7.2.1 Previous Theoretical Proposals

Broadly, I have provided a collection of empirical data on the verbal passive that must be accounted for when formalizing a theory of children's acquisition, particularly with respect to the lexical semantic distinctions that seem to matter. Current theoretical approaches – including the A-Chain Deficit Hypothesis (Borer and Wexler, 1987), the Theta-Transmission Hypothesis (Hirsch and Wexler, 2006), and the Semantic Coercion/Smuggling Hypothesis (Gehrke and Grillo, 2009; Grillo, 2008; Snyder and Hyams, 2015) – often assume a binary distinction alone (e.g., whether a verb is +/-ACTIONAL). The results from the behavioral studies in Chapters 4 and 6 expand upon the empirical foundation of children's linguistic behavior with regards to the lexical verb asymmetry. Furthermore, I have provided evidence that we should re-characterize this lexical asymmetry through the lens of lexical semantic profiles instead of just a singular lexical feature such as ACTIONALITY. This recharacterization of children's passivization behavior could aid proponents of current theoretical approaches in modifying their proposals to be able to account for children's linguistic behavior.

7.2.2 Status of Lexical Features

From a knowledge representation standpoint, I again note that the eight lexical features included in the lexical semantic profiles investigated here were proposed as a description of the relevant verb properties. However, it is unclear if they are truly independent from each other or if instead the set of features might be reducible to a different set. For example, the lexical features ACTIONAL and AGT-PAT might be better represented by a single

feature because they had the same value for all five lexical semantic profiles, or OBJECT-EXPERIENCERS and SUBJECT-EXPERIENCERS are inherently +STATIVE. Future theoretical work can investigate other lexical semantic feature representations that are also compatible with the empirical data collected so far. For the developmental computational model developed in this dissertation, changes in the relationship between the lexical features would impact the likelihood calculations from child-directed speech, on the basis of these correlations or feature reduction. In particular, if the features are not independent, we would not be able to calculate the likelihood by multiplying their independent likelihoods (e.g., $p(\text{ACTIONAL}=1|+\text{pass}) * p(\text{AGT-PAT}=1|+\text{pass})$). Instead, we might need to calculate joint likelihoods for correlated features (e.g. $p(\text{ACTIONAL}=1, \text{AGT-PAT}=1 | +\text{pass})$).

Another open issue is the question of why English-speaking children are filtering their input to specific lexical features at certain ages and what might trigger their development of input filters (i.e., what might trigger changing from one input filter to another). One idea would be that children are utilizing prior knowledge to help them constrain and navigate their hypothesis space. There are several possibilities that come to mind for how this may occur. First, while this dissertation has focused on verbal *be*-passives in English, there are other types of passives that English-speaking children would have to learn, namely verbal *get*-passives and adjectival passives (see Chapter 2.4). Since *get*-passives and adjectival passives are more semantically restricted (but learned earlier) (e.g. Borer and Wexler, 1987; Gotowski, 2019), children may be leveraging linguistic knowledge that they may already know about *get*-passives and adjectival passives and use these semantic restrictions as their starting point for verbal *be*-passives as well. This can explain why children's knowledge of the passive voice does not reflect their input, even at the earliest stage of development (i.e., why do children not generalize that all +TRANSITIVE verbs passivize at a young age when the verbs in child-directed speech are overwhelmingly +TRANSITIVE, see Chapter 3). Second, Orfitelli (2012) suggests that there is a parallel acquisition of both verbal passives and raising constructions past an Experiencer (RPE) such as "Tom seems

to Lucy to be nice”, where Lucy is the Experiencer of the thought that Tom is nice. In particular, [Orfitelli](#) found almost a 100% correspondence between any given child’s ability to comprehend the passives of +SUBJECT-EXPERIENCER verbs such as *remember*, *see*, *hear*, and *love*, and the same child’s ability to comprehend RPE constructions with *seem*. Explanations for this tight link between the acquisition of verbal passives and RPE constructions with regards to input filters include: (i) the acquisition of RPE construction triggers children to consider input filters that heed the SUBJECT-EXPERIENCER feature so that they classify +SUBJECT-EXPERIENCER verbs as passivizable, or (ii) there is another (un-)related linguistic construction that triggers both the acquisition of RPE constructions and the input filter needed to classify +SUBJECT-EXPERIENCER verbs as passivizable. And third, [Landau \(2010\)](#) has proposed that a language can allow +OBJECT-EXPERIENCER verbs to passivize if and only if it allows at least one of the following syntactic options: pseudo-passives (where –TRANSITIVE verbs can appear in a passive-like construction when followed by a post-verbal preposition), and/or quirky passives (where the subject NP does not bear nominative case). Similar to the previous explanation, any tight link between the existence of pseudo-passives or quirky passives and the passivization of +OBJECT-EXPERIENCER verbs could be because pseudo-passives or quirky passives serve as a trigger for children to consider input filters that heed the OBJECT-EXPERIENCER feature so that they classify +OBJECT-EXPERIENCER verbs as passivizable.

What links the three explanations above is the idea that while linguistic knowledge such as *get*-passives, RPE constructions, and pseudo-passives may not be directly related to how children decide which verb classes are classified as passivizable (because this comes from the distribution of lexical features in the linguistic intake), children may be using prior knowledge of these linguistic constructions to determine the input filter that is appropriate to use for this task. The idea that certain prior linguistic knowledge triggers children’s language development is similar in spirit to the concept of linguistic parameters in the generative framework ([Chomsky, 1981](#)). A linguistic parameter is a property

that varies across human languages and thus a value that is set for a particular parameter may have implications for seemingly unrelated grammatical properties within a language. For example, a language for which a parameter is set to allow for pseudo-passives would as a consequence allow passives of +OBJECT-EXPERIENCER verbs (Landau, 2010). In terms of developmental computational modeling, hierarchical Bayesian modeling (i.e., different levels of abstraction regarding a hypothesis space) has been used to concretely implement linguistic parameters in terms of what are called “overhypotheses” (Kemp et al., 2007; Perfors et al., 2010; Pearl and Lidz, 2013; Pearl, 2021). So while a learner can make generalizations from observable data with particular regards to specific verb classes that do and do not allow passivization, an overhypothesis is a generalization that a learner can make about passivization overall in particular with regards to the specific input filter that the learner uses to constrain her hypothesis space. So a hierarchical learning model can be used to implement a learning mechanism where multiple levels of information/knowledge can be shared and transferred via an overhypothesis that projects down to all hypotheses beneath it. In our previous example, an overhypothesis that a learner can make is that there is a tight link between the presence of pseudo-passives in the observable data and the input filter that heeds the OBJECT-EXPERIENCER feature for the passive. Thus, the prior linguistic knowledge of pseudo-passives can be leveraged by the learner to constrain her hypothesis space to particular input filters that then allow her to make classification decisions regarding which verbs can and cannot allow passivization.

7.3 Future Work

7.3.1 The Passive of OBJECT-EXPERIENCERS

Some of the Profile 2 verbs such as *surprise* and *frighten* have been argued by Hirsch and Hartman (2006) to fall under Belletti and Rizzi’s (1988) “Preoccupare” class of psych verbs. If this is the case, then it is the active sentences of these verbs, rather than the passive, that

should be difficult for young children to comprehend. Because children were effectively at ceiling for all active control items, including active sentences with *surprise* and *frighten*, we suspect that any predicted difficulty of verbs that fall under this “Preoccupare” class would appear in children younger than the ones we tested (cf. [Borga and Snyder \(2018b\)](#) for evidence of French-speaking children’s difficulty with active Object-Experiencers sentences until four years of age).

7.3.2 Short Passives

The focus of this dissertation has been on the long verbal *be*-passives in English, given the uncertainty about whether the underlying syntactic structure was the same for short passives and long verbal *be*-passives. If the syntactic structures do in fact differ (as suggested by [Borer and Wexler 1987](#)), then the LEXICAL SEMANTIC PROFILE HYPOTHESIS developed here for long verbal *be*-passives does not make predictions about children’s development. In contrast, if this syntactic structure is in fact the same (as suggested by theoretical work ([Chomsky, 1957](#); [Fox and Grodzinsky, 1998](#); [Collins, 2005b](#)) and acquisition work ([Horgan, 1978](#); [Gordon and Chafetz, 1990](#); [Hirsch and Wexler, 2006](#); [O’Brien et al., 2006](#); [Messenger et al., 2011](#))), I would predict the same developmental trajectory with both forms of the verbal passive.

7.3.3 Cross-Linguistic Acquisition

My hope is that the results of this dissertation will motivate future research looking into the role of input in the acquisition of non-English passives. For example, there are multiple languages where children exhibit a lexical verb asymmetry in their passive comprehension (e.g., French ([Sinclair et al., 1971](#)); German ([Mills, 1985](#)); Hebrew ([Berman, 1985](#))), and there are also languages where there is reportedly no asymmetry (e.g., Sesotho, [Demuth et al. 2010](#)). A direction for post-dissertation research will be to look at the child-directed input for these languages to see differences and similarities to the results ob-

tained here for English.

While this dissertation has mainly focused on English, it is possible that the LEXICAL SEMANTIC PROFILE HYPOTHESIS applies cross-linguistically. That is, for languages that have reported a lexical asymmetry – children succeeding at passives for some verbs earlier than other verbs – the LEXICAL SEMANTIC PROFILE HYPOTHESIS would predict a developmental trajectory similar to what we have seen with English-speaking children. Specifically, certain lexical semantic profiles would be understood in the verbal passive earlier than other profiles. So, for instance, even for languages where children seem to comprehend passives quite early (e.g., Sesotho, [Demuth et al. 2010](#) –though see [Crawford 2012](#)), the LEXICAL SEMANTIC PROFILE HYPOTHESIS predicts that children comprehend verbs from certain lexical semantic profiles earlier than verbs from other lexical semantic profiles. More generally, while the developmental trajectory of the verbal passive for English-speaking children corresponds to specific ages in English, the LEXICAL SEMANTIC PROFILE HYPOTHESIS is concerned with the relative ordering of the profiles with respect to acquisition, and so is not tied to any specific age when applied cross-linguistically. Additionally, the predicted relative ordering of the profiles in a given language would be influenced by the lexical semantic profiles that are in fact passivizable in that language. For instance, for languages that systematically do not allow Profiles 4 and 5 to passivize (e.g., Irish and Scot Gaelic, [Landau 2010](#)), then the LEXICAL SEMANTIC PROFILE HYPOTHESIS would only predict the ordering of Profiles 1, 2, and 3 (in particular, that Profile 1 should be understood in the verbal passive before Profiles 2 and 3). Future experimental work may be able to assess if there is in fact a lexical asymmetry even in those languages where children appear to comprehend the passive much earlier than in English and whether this lexical asymmetry follows the same developmental trajectory that we see with English-speaking children.

7.4 Conclusion

The findings of this dissertation underscore the role of lexical semantic features – and in fact, collections of these features into profiles – for children’s observed age of acquisition of the long verbal passives in English. I have identified the developmental trajectory of children’s comprehension of this passive, linking it to lexical semantic profiles that apply to multiple verbs. I have implemented a concrete developmental theory via developmental computational modeling about how children’s intake could be changing with respect to the lexical features they attend to, and suggested that that is what explains children’s observable behavior on comprehending the passive. In a truth Value Judgment Task and a novel verb-learning task, I have demonstrated what lexical knowledge children and adults seem to use to decide if a verb should be passivized, highlighting more clearly (i) the target of development for a lexical-feature-based approach, and (ii) that there is a difference in performance (in adults) between familiar and novel verbs, which demonstrates that some passive knowledge may be generalizable (and so can apply to novel verbs) while some passive knowledge is not. More generally, the data gathered so far provide a consolidated empirical foundation that must be accounted for when formalizing a theory of children’s acquisition of the verbal passive and highlight the importance of considering lexical semantics when investigating the development of syntactic knowledge.

Appendix

A.1 Summaries of studies used in the synthesis of experimental studies

Crain, Thornton, and Murasugi (2009)

Experiment - Were asked to pose questions to another experimenter

- Task/Procedure: Elicited Production Task
- # of Subjects: 35
- Age Range: 3;04-5;00 (for 32 of the children)
- Verbs Used: (Drawn from sample elicited data) *knock, eat, push, hit, lick, scratch, shoot, kill, pick up, crash, kiss, bite, punch*
- Long/Short: Long
- Results: 29 children produced at least one long verbal passive; 24 produced three or more long passives; as young as 3;04

de Villiers and de Villiers (1973)

Experiment - "Show me X"

- Task/Procedure: Act-Out Task
- # of Subjects: 33
- Age Range: 1;07-3;01
- Verbs Used: *kiss, push, hit, vite, bump, touch*
- Long/Short: Long
- Results:

	Actives		Passives	
	% Correct	% Reversed	% Correct	% Reversed
Group IV (2;08-3;01)	87%	12.2%	34.4%	65.6%

Fox and Grodzinsky (1998)

Experiment 1 - divided already small sample into even smaller groups for analysis

- Task/Procedure: Truth Value Judgment Task
- # of Subjects: 13
- Age Range: 3;06-5;05
- Verbs Used: actional = [*touch, chase*]; non-actional = [*hear, see*]
- Long/Short: Long and Short; Short for non-actionals only
- Results: 2 children were adult-like; 8 children only had problems with long non-actionals; and 3 children had problems with long and short non-actionals

Gordon and Chafetz (1990)

Experiment 1 - Child-directed input was analyzed

- Task/Procedure: Corpus Analysis
- # of Subjects: Brown Corpus (Adam, Eve, and Sarah); 86,655 utterances
- Age Range: 1;06 - 5;01
- Results: Passives presented 36/1000 of all input utterances; only 4 long passives total; 93% of verbal passives that appeared were actional. Adjectival and Adjunct passives were also collected.

Experiment 2 - Presented with a story; Had to answer Yes/No questions; "Was John hated (by the peas)?"

- Task/Procedure: Comprehension Study
- # of Subjects: 30 3-year-olds and 4-year-olds
- Age Range: 3;00-4;02 (MA=3;06); 4;02-5;06 (MA=4;06)
- Verbs Used: actional = [*drop, eat, carry, kiss, hold, wash, shake, hug, kick*]; non-actional = [*watch, forget, hear, know, remember, believe, like, see, hate*]
- Long/Short: Long and Short
- Results:

	Long Passives		Short Passives	
	Actional	Non-Actional	Actional	Non-Actional
3 yr	0.69	0.41	0.77	0.48
4 yr	0.58	0.29	0.64	0.39

Hirsch and Wexler (2006)

Experiment 1 -

- Task/Procedure: Picture Selection Task
- # of Subjects: 60 3-, 4-, and 5-year-olds
- Age Range: 3;00-5;11 (MA=4;05)
- Verbs Used: actional = [*push, kiss, kick, hold*]; psychological = [*remember, love, hate, see*]
- Long/Short: Long and Short
- Results:

Group	Long Actionals	Short Actionals	Long Psych	Short Psych
3-	66.2%	72.5%	35.0%	30.0%
3+	53.7%	76.2%	33.8%	35.0%
4-	73.8%	80.0%	38.8%	40.0%
4+	65.0%	76.2%	45.0%	50.0%
5-	88.7%	87.5%	38.8%	47.5%
5+	92.5%	92.5%	43.8%	55.0%

Liter, Huelskamp, Weerakoon, and Munn (2015)

Experiment 1 - eventive & agentive vs eventive & non-agentive

- Task/Procedure: TVJT
- # of Subjects: 17 adults and 14 children
- Age Range: 4;05 - 6;02 (MA = 5;01)
- Verbs Used: eventive & agentive = [*paint, fix, wash*]; eventive & non-agentive = [*forget, find, spot*]
- Long/Short: Long
- Results:
Eventive & agentive and eventive & non-agentive = above chance
Eventive & agentive > eventive & non-agentive

Experiment 2 - non-eventive & agentive vs non-eventive & non-agentive

- Task/Procedure: TVJT
- # of Subjects: 16 adults and 12 children
- Age Range: 3;09 - 5;10 (MA = 4;11)
- Verbs Used: eventive & non-agentive = [*forget, find, spot*]; non-eventive & non-agentive = [*know, hate, love*]
- Long/Short: Long
- Results:
eventive & non-agentive = above chance; non- eventive & non-agentive = chance
Eventive & non-agentive marginally significantly better non-eventive & non-agentive
($p = .07$)
But eventive & non-agentive from Exp. 1 > non-eventive & non-agentive from Exp. 2

Maratsos and Abramovitch (1975)

Experiment 1

- Task/Procedure: Act-Out Task
- # of Subjects: 40
- Age Range: 2;11-3;11
- Verbs Used: *kick, kiss, push, hit, bite, bump, tickle, touch*
- Long/Short: Long and Short
- Results: 13 subjects showed stable competence in both long and short passives; 20 demonstrated stable competence in neither type; three subjects showed stable competence in short but not long passives, while four subjects showed the complementary pattern of competence in long but not short passives.

Maratsos, Fox, Becker, and Chalkley (1985)

Experiment 1 - "Who did it?"

- Task/Procedure: Presented with sentence, answer to question
- # of Subjects: 38 4- and 5-year-olds
- Age Range: 5-year-old (MA = 5;06); 4-year-olds (MA = 4;07)
- Verbs Used: actional = [*find, hold, shake, wash*]; mental state = [*remember, forget, know, like, miss, see, hear, watch*]; *smell*; novel verbs

- Long/Short: Long
- Results:

Actionals	Mental States	Novel Verbs
0.67	0.40	0.47

Actional Verb	% Correct	Mental States	% Correct
<i>drop</i>	0.66	<i>watch</i>	0.47
<i>hold</i>	0.69	<i>know</i>	0.43
<i>shake</i>	0.67	<i>hear</i>	0.45
<i>wash</i>	0.67	<i>like</i>	0.43
		<i>remember</i>	0.38
<i>smell</i>	0.60	<i>see</i>	0.41
		<i>forget</i>	0.31

Experiment 2

- Task/Procedure: Picture Selection Task
- # of Subjects: 80 4-, 5-, 7-, 9-, and 11-year-olds
- Age Range: 4-year-olds (MA=4;05); 5-year-olds (MA=5;04); 6-year-olds (MA=6;10); 8-9-year-olds (MA=8;10); 10-11-year-olds (MA=10;10)
- Verbs Used: actionals = [*wash, kiss, push, kick, find, hold*]; mental states = [*see, hear, like, love, hate, remember*]
- Long/Short: Long
- Results:

Age	Actionals	Mental States
4 yr	0.85**	0.34
5 yr	0.91**	0.65*
7 yr	0.92**	0.62
9 yr	0.96**	0.87**
11 yr	0.99**	0.99**

Age	<i>like</i>	<i>love</i>	<i>hate</i>	<i>remember</i>	<i>see</i>
4 yr	0.42	0.35	0.42	0.29	0.27
5 yr	0.75**	0.65**	0.69*	0.67*	0.48
7 yr	0.77**	0.69**	0.52	0.63	0.48
9 yr	0.96**	0.90**	0.90**	0.81**	0.78**
11 yr	1.00**	0.98**	1.00**	1.00**	0.94**

Messenger, Branigan, McLean, and Sorace (2012)

Experiment 1

- Task/Procedure: Picture Selection Task
- # of Subjects: 24
- Age Range: 3;04 - 4;11 (MA = 4:02)
- Verbs Used: agent-pat actional - [*bite, carry, hit, pat, pull, squash*]; subj-exp non-actional = [*hate, hear, ignore, love, remember, see*]; obj-exp non-actional = [*annoy, frighten, scare, shock, surprise, upset*]
- Long/Short: Long
- Results:

	Mean Score (Out of 6)	(Converted) Percentage
Actional	4.63	77%
Subj-Exp	2.42	40%
Obj-Exp	4.13	69%

Experiment 2 - Syntactic Priming Experiment

- Task/Procedure: Production Study
- # of Subjects: 24 (Same children from Exp 1)
- Age Range: 3;04 - 4;11 (MA = 4:02)
- Verbs Used: agent-pat actional - [*chase, hug, kick, kiss, lick, pinch, punch, push, scratch, shake, tickle, wash*]; subj-exp non-actional = [*hate, hear, ignore, love, remember, see*]; obj-exp non-actional = [*annoy, frighten, scare, shock, surprise, upset*]
- Long/Short: Long
- Results:

	Prime	Mean (SD)
Active	Sub-Exp	0.16 (0.29)
	Obj-Exp	0.10 (0.23)
Passive	Sub-Exp	0.32 (0.33)
	Obj-Exp	0.39 (0.36)

Nguyen, Lillo-Martin, and Snyder (2018)

Experiment - Manipulated 2- vs 3- character stories

- Task/Procedure: Truth Value Judgment Task
- # of Subjects: 20 4-year-olds
- Age Range: 3;06 - 6;01 (MA = 4;06)
- Verbs Used: actional = [*chase, hug*]; non-actional = [*like, see*]
- Long/Short: Long
- Results:

	Long Passive - 2-Characters	Long Passives - 3-Characters
Actional Verb	73% **	75% **
Non-Actional Verb	49%	61%

O'Brien, Grolla, and Lillo-Martin (2006)

Experiment 1 - only 3-character stories

- Task/Procedure: Truth Value Judgment Task
- # of Subjects: 11 4-year-olds
- Age Range: 4;00 - 4;10 (MA = 4;04)
- Verbs Used: actional = [*chase, hug*]; non-actional = [*hear, see*]
- Long/Short: Short and Long
- Results:

	Short Passive - 3-Characters	Long Passives - 3-Characters
Actional Verb	88%**	93%**
Non-Actional Verb	100%**	82%*

Experiment 2 - Manipulated 2- vs 3- character stories

- Task/Procedure: Truth Value Judgment Task
- # of Subjects: 7 3-year-olds
- Age Range: 3;02 - 4;02 (MA = 3;06)
- Verbs Used: actional = [*chase, hug*]; non-actional = [*like, see*]
- Long/Short: Long
- Results:

	Long Passive - 2-Characters	Long Passives - 3-Characters
Actional Verb	55%	85%*
Non-Actional Verb	65%	95%**

Orfitelli (2012)

Experiment -

- Task/Procedure: Picture-Selection Task
- # of Subjects: 30
- Age Range: 4;0-6;11
- Verbs Used: actional = [*carry, kick, kiss, push*], actional = non-actional = [*love, remember, hear, see*]
- Long/Short: Long and Short
- Results:

	Active		Short Passive		Long Passives	
	Actional	Non-Actional	Actional	Non-Actional	Actional	Non-Actional
4 years (N=10)	99%	96%	80%	34%	82%	38%
5 years (N=10)	97%	97%	96%	47%	92%	39%
6 years (N=10)	100%	100%	100%	79%	100%	82%

A.2 List of verbs used in passive voice in child-directed speech

<i>adjust</i>	<i>burn</i>	<i>cut</i>	<i>fit</i>	<i>lose</i>	<i>operate</i>	<i>put</i>	<i>slip</i>	<i>straighten</i>	<i>turn</i>
<i>attach</i>	<i>bury</i>	<i>deliver</i>	<i>fix</i>	<i>love</i>	<i>own</i>	<i>repair</i>	<i>smash</i>	<i>surprise</i>	<i>twist</i>
<i>batter</i>	<i>call</i>	<i>dress</i>	<i>flatter</i>	<i>make</i>	<i>paint</i>	<i>rip</i>	<i>snow</i>	<i>take</i>	<i>untie</i>
<i>blame</i>	<i>catch</i>	<i>dry</i>	<i>fold</i>	<i>marry</i>	<i>peel</i>	<i>run</i>	<i>soak</i>	<i>tangle</i>	<i>warm</i>
<i>block</i>	<i>chew</i>	<i>eat</i>	<i>freeze</i>	<i>meet</i>	<i>pet</i>	<i>scare</i>	<i>spank</i>	<i>tattoo</i>	<i>wash</i>
<i>blow</i>	<i>clean</i>	<i>embroider</i>	<i>glue</i>	<i>melt</i>	<i>pick</i>	<i>seal</i>	<i>squash</i>	<i>teach</i>	<i>water</i>
<i>book</i>	<i>close</i>	<i>enlarge</i>	<i>hit</i>	<i>mess</i>	<i>place</i>	<i>set</i>	<i>start</i>	<i>tear</i>	<i>wind</i>
<i>born</i>	<i>collect</i>	<i>excuse</i>	<i>hug</i>	<i>milk</i>	<i>play</i>	<i>sew</i>	<i>steal</i>	<i>throw</i>	<i>wipe</i>
<i>bother</i>	<i>come</i>	<i>expect</i>	<i>hurt</i>	<i>mix</i>	<i>plop</i>	<i>shape</i>	<i>step</i>	<i>tickle</i>	<i>wrap</i>
<i>break</i>	<i>cook</i>	<i>fake</i>	<i>ignore</i>	<i>move</i>	<i>plug</i>	<i>shrink</i>	<i>stick</i>	<i>tie</i>	<i>write</i>
<i>brush</i>	<i>cover</i>	<i>fill</i>	<i>kiss</i>	<i>murder</i>	<i>prepare</i>	<i>sign</i>	<i>stop</i>	<i>tire</i>	
<i>buckle</i>	<i>crack</i>	<i>finish</i>	<i>leave</i>	<i>name</i>	<i>push</i>	<i>skin</i>	<i>store</i>	<i>tuck</i>	

A.3 Materials used in the Truth-Value Judgment Task

BELIEVE - Active

Uncle is babysitting his nephew, Luke.

Luke runs into the living room and says to Uncle.

Luke: I saw a unicorn today. It was really big and shiny. Do you believe me?

Uncle: Of course I believe you. I saw one too! Do you believe me?

Luke: No! I was the only one that saw the unicorn.

BELIEVE - Passive

Auntie is babysitting her nephew, Wyatt.

Auntie: Wyatt, I ate all of my vegetables today. Do you believe me?

Wyatt: Of course, I believe you! You love vegetables. I also ate all of my vegetables today.

Auntie: But I didn't pack any vegetables in your lunch today! I don't believe you.

BELIEVE - Passive

Joel and Jane are best friends.

Jane: My parents are taking me to Disney World for my birthday. Do you believe me?

Joel: I definitely believe you. Your parents are so nice. My parents forgot about my birthday.

Jane: I don't believe you. I heard that your parents are throwing you a birthday party this year!

DISCOVER - Active

This is a story about a lion and Edward the explorer.

The lion is roaming the safari. Then, Edward the explorer arrives.

Edward: What's this? Look, I've discovered a lion in the safari.

DISCOVER - Passive

The thief is hiding behind a tree with his stolen diamond ring.

Thief: Ha! I'm safe behind this tree with my ring. No one will be able to discover me in this park. I'll take this time to sleep.

Maria is walking around the park.

Maria: Hmm... Is anyone here? Who's this? I've discovered the diamond thief!

DISCOVER - Passive

This is a story about Michael and a pirate. The pirate is hiding away on an island with her treasure chest.

Pirate: Arg! I'm safe on this island with my treasure. I do not see anyone so no one will discover me and my treasure!

Michael is sailing the ocean when he came upon an island.

Michael: Ah! A deserted island. Is anyone here? Oh look, I've discovered a pirate!

FIND - Active

The thief is hiding behind the tree with the diamond ring.

Thief: I will hide behind this tree. No one is around to find me. I'll sleep for a little bit.
Lincoln is walking around the park.

Lincoln: I wonder if there is anything behind this tree. Look, I found someone!

Thief: Aak! You found me!

FIND - Passive

This is a story about Jason and the farmer. The farmer is looking for his tools.

Farmer: hmmm, I wondering if my tools are behind this big doghouse! I can't see anything so no one will be able to find me behind here.

Jason was walking around the backyard.

Jason: hmmm.... That's a really big dog house. I'll just walk around it to get to the other side of the backyard. Oh look, it's the farmer! I found the farmer.

FIND - Passive

This is a story about June and Lincoln. June is looking for her diamond ring.

June: I wonder where this ring could be. I'll look behind this big bench here. It's hard for people to see me when I'm behind this bench. I'm sure no one will find me here while I'm looking for this ring!

Lincoln is enjoying a lovely day at the park.

Lincoln: What a great walk! I'll sit down on this bench and rest a bit. Oh, who's this? Looks like I found my friend, June!

FIX - Active

The Grey Robot and the Green Robot are working in the office today. The Grey Robot and the Green Robot accidentally bumped into the cabinets and some of their screws fell onto the floor.

Grey Robot : I only have a pen. Pens won't fix this problem.

Green Robot : That's okay, I have a very good screwdriver. I will fix you, Grey Robot!

FIX - Passive

The Round Robot and the Square Robot are hanging out in the laboratory one day.

Suddenly, both their arms fell off their body!

Round Robot: I only have a paintbrush. Paintbrushes can't fix Robots.

Square Robot: Don't worry, I have a wrench. I can fix your arm!

FIX - Passive

The Blue Robot and the Yellow Robot are together in the laboratory mixing chemicals.

There was a big explosion. Looks there are wires everywhere.

Yellow Robot: I only have scissors. Scissors will not fix our wires.

Blue Robot: I have superglue! I will fix you!

FORGET - Active

Mommy and Audrey are at the mall. Audrey is staring at the toys when Mommy walks off.

Audrey: Mommy! Where are you going? Did you forget me?

Mommy: Oh gosh, it's true. I'm sorry. I forgot you in the store.

FORGET - Passive

Lucas and Mary are at the playground. Mary is playing by herself.

Lucas: Hey, I did not forget you! We were playing together last week!

Mary: No, I forgot who I was playing with last week.

FORGET - Passive

Chase and Chloe are at school. Chase is playing by himself.

Chloe: Hey, I did not forget you! I played at your house last week.

Chase: You did? I forgot who was at my house last week.

FRIGHTEN - Active

Cole and Aurora are going to a party. Pirates frighten Aurora but Cole loves pirates.

Cole: Your costume is awesome, Aurora. Look, I'm dressed as a pirates. Do I frighten you?

Aurora: Yes, you frighten me! Pirates don't look very nice.

FRIGHTEN - Passive

Andrew and Caroline are at a Halloween party. Mummies frighten Caroline but Andrew loves mummies.

Andrew: Look, Caroline, I'm dressed as a mummy. Do I frighten you?

Caroline: Yes, you frighten me! I can barely see you coming for me!

FRIGHTEN - Passive

Owen and Jackie are at a costume party. Ladybugs frighten Owen but Jackie loves ladybugs.

Jackie: Owen, I love your witch costume! Do you see my ladybug costume? Does it frighten you?

Owen: Yes, Jackie, you frighten me. You know that I don't like ladybugs!

LOVE - Active

The boy is playing around with his cat. The boy loves it when the cat plays with him.

Boy: oh my goodness, you are so cute, kitty. I love you! Do you love me?

Cat: *hisses* no, I do not love you!

LOVE - Passive

Uncle is babysitting his nephew, Alexander. Uncle and Alexander are talking in the living room.

Uncle: You are the cutest kid I know. I love you very much. Do you love your uncle, Alexander?

Alexander: No! I only love mommy and daddy.

LOVE - Passive

Jake and Isabelle are neighbors. They play with each other every day.

Isabelle: Jake, I don't love you because I'm jealous of your new clothes.

Jake: But I love you because you're my only friend, Isabelle!

SURPRISE - Active

Cole and Amelia are best friends. It's Amelia's birthday and Cole wants to do something for her.

Cole: Amelia, I want to surprise you! Happy birthday!

Amelia: Yay! I was not expecting this at all. I am so happy!

SURPRISE - Passive

Clara and Owen are at a baseball field. Owen bought something very special for Clara.

Owen: Look, Clara! I want to surprise you. New baseball mitts!

Clara: Thanks, Owen! You really surprised me! I have nothing to surprise you with today.

SURPRISE - Passive

Mommy and Caroline are shopping at the toy store. Mommy bought Caroline something very special.

Mommy: Caroline, I want to surprise you! Look, a new bike!

Caroline: Wow! So cool! But I can't surprise you, Mommy, you have everything!

SPOT - Active

The boy is playing around with his pet monkey. When the boy wasn't looking, the monkey climbed up one of the trees.

Boy: ah, I spot you hiding in the tree, Monkey! You silly monkey.

SPOT - Passive

Auntie is babysitting her niece, Audrey. Audrey goes behind the curtain.

Audrey: I'm hiding from Auntie behind this big curtain. I can't see anything but I bet Auntie will not spot me.

Auntie: Oh, there are little shoes poking out from the bottom of the curtain. I spot you, Audrey!

SPOT - Passive

Uncle is babysitting his niece, Chloe. Chloe goes behind the brooms.

Chloe: I'm hiding from Uncle behind these brooms. I can't see anything but I bet Uncle will not spot me.

Uncle: Oh, there are pigtails poking out from the brooms. I spot you, Chloe!

WASH - Active

Harvey is playing with his dog in the backyard.

Look how dirty they're getting!

Harvey: You're so dirty, dog. I need to wash you before we go back into the house.

WASH - Passive

Ava and Andrew are in the kitchen. Look! Ava is spilling juice everywhere.

Ava: Aww! There's juice on my dress. I have nothing to wash this off with!

Andrew: I have a wet towel. Let me wash you, Ava.

WASH - Passive

Benji and Anna are in the bathroom. Benji and Anna are dirty from playing outside.

Anna: I can't find anything to wash you with, Benji.

Benji: I found a sponge! I don't mind being dirty; I will wash you first, Anna.

A.4 256 models of filtered input on the basis of eight lexical features with 1 indicating the feature is heeded and 0 indicating the feature is not

	STATIVE	VOLIT.	AFFECTED	OBJ-EXP	SUBJ-EXP	AGT-PAT	ACTIONAL	TRANS
1	0	0	0	0	0	0	0	0
2	0	0	0	0	0	0	0	1
3	0	0	0	0	0	0	1	0
4	0	0	0	0	0	0	1	1
5	0	0	0	0	0	1	0	0
6	0	0	0	0	0	1	0	1
7	0	0	0	0	0	1	1	0
8	0	0	0	0	0	1	1	1
9	0	0	0	0	1	0	0	0
10	0	0	0	0	1	0	0	1
11	0	0	0	0	1	0	1	0
12	0	0	0	0	1	0	1	1
13	0	0	0	0	1	1	0	0
14	0	0	0	0	1	1	0	1
15	0	0	0	0	1	1	1	0
16	0	0	0	0	1	1	1	1
17	0	0	0	1	0	0	0	0
18	0	0	0	1	0	0	0	1
19	0	0	0	1	0	0	1	0
20	0	0	0	1	0	0	1	1
21	0	0	0	1	0	1	0	0
22	0	0	0	1	0	1	0	1
23	0	0	0	1	0	1	1	0
24	0	0	0	1	0	1	1	1
25	0	0	0	1	1	0	0	0
26	0	0	0	1	1	0	0	1
27	0	0	0	1	1	0	1	0
28	0	0	0	1	1	0	1	1
29	0	0	0	1	1	1	0	0
30	0	0	0	1	1	1	0	1
31	0	0	0	1	1	1	1	0
32	0	0	0	1	1	1	1	1
33	0	0	1	0	0	0	0	0
34	0	0	1	0	0	0	0	1
35	0	0	1	0	0	0	1	0
36	0	0	1	0	0	0	1	1
37	0	0	1	0	0	1	0	0

	STATIVE	VOLIT.	AFFECTED	OBJ-EXP	SUBJ-EXP	AGT-PAT	ACTIONAL	TRANS
38	0	0	1	0	0	1	0	1
39	0	0	1	0	0	1	1	0
40	0	0	1	0	0	1	1	1
41	0	0	1	0	1	0	0	0
42	0	0	1	0	1	0	0	1
43	0	0	1	0	1	0	1	0
44	0	0	1	0	1	0	1	1
45	0	0	1	0	1	1	0	0
46	0	0	1	0	1	1	0	1
47	0	0	1	0	1	1	1	0
48	0	0	1	0	1	1	1	1
49	0	0	1	1	0	0	0	0
50	0	0	1	1	0	0	0	1
51	0	0	1	1	0	0	1	0
52	0	0	1	1	0	0	1	1
53	0	0	1	1	0	1	0	0
54	0	0	1	1	0	1	0	1
55	0	0	1	1	0	1	1	0
56	0	0	1	1	0	1	1	1
57	0	0	1	1	1	0	0	0
58	0	0	1	1	1	0	0	1
59	0	0	1	1	1	0	1	0
60	0	0	1	1	1	0	1	1
61	0	0	1	1	1	1	0	0
62	0	0	1	1	1	1	0	1
63	0	0	1	1	1	1	1	0
64	0	0	1	1	1	1	1	1
65	0	1	0	0	0	0	0	0
66	0	1	0	0	0	0	0	1
67	0	1	0	0	0	0	1	0
68	0	1	0	0	0	0	1	1
69	0	1	0	0	0	1	0	0
70	0	1	0	0	0	1	0	1
71	0	1	0	0	0	1	1	0
72	0	1	0	0	0	1	1	1
73	0	1	0	0	1	0	0	0
74	0	1	0	0	1	0	0	1
75	0	1	0	0	1	0	1	0
76	0	1	0	0	1	0	1	1
77	0	1	0	0	1	1	0	0
78	0	1	0	0	1	1	0	1
79	0	1	0	0	1	1	1	0

	STATIVE	VOLIT.	AFFECTED	OBJ-EXP	SUBJ-EXP	AGT-PAT	ACTIONAL	TRANS
80	0	1	0	0	1	1	1	1
81	0	1	0	1	0	0	0	0
82	0	1	0	1	0	0	0	1
83	0	1	0	1	0	0	1	0
84	0	1	0	1	0	0	1	1
85	0	1	0	1	0	1	0	0
86	0	1	0	1	0	1	0	1
87	0	1	0	1	0	1	1	0
88	0	1	0	1	0	1	1	1
89	0	1	0	1	1	0	0	0
90	0	1	0	1	1	0	0	1
91	0	1	0	1	1	0	1	0
92	0	1	0	1	1	0	1	1
93	0	1	0	1	1	1	0	0
94	0	1	0	1	1	1	0	1
95	0	1	0	1	1	1	1	0
96	0	1	0	1	1	1	1	1
97	0	1	1	0	0	0	0	0
98	0	1	1	0	0	0	0	1
99	0	1	1	0	0	0	1	0
100	0	1	1	0	0	0	1	1
101	0	1	1	0	0	1	0	0
102	0	1	1	0	0	1	0	1
103	0	1	1	0	0	1	1	0
104	0	1	1	0	0	1	1	1
105	0	1	1	0	1	0	0	0
106	0	1	1	0	1	0	0	1
107	0	1	1	0	1	0	1	0
108	0	1	1	0	1	0	1	1
109	0	1	1	0	1	1	0	0
110	0	1	1	0	1	1	0	1
111	0	1	1	0	1	1	1	0
112	0	1	1	0	1	1	1	1
113	0	1	1	1	0	0	0	0
114	0	1	1	1	0	0	0	1
115	0	1	1	1	0	0	1	0
116	0	1	1	1	0	0	1	1
117	0	1	1	1	0	1	0	0
118	0	1	1	1	0	1	0	1
119	0	1	1	1	0	1	1	0
120	0	1	1	1	0	1	1	1
121	0	1	1	1	1	0	0	0

	STATIVE	VOLIT.	AFFECTED	OBJ-EXP	SUBJ-EXP	AGT-PAT	ACTIONAL	TRANS
122	0	1	1	1	1	0	0	1
123	0	1	1	1	1	0	1	0
124	0	1	1	1	1	0	1	1
125	0	1	1	1	1	1	0	0
126	0	1	1	1	1	1	0	1
127	0	1	1	1	1	1	1	0
128	0	1	1	1	1	1	1	1
129	1	0	0	0	0	0	0	0
130	1	0	0	0	0	0	0	1
131	1	0	0	0	0	0	1	0
132	1	0	0	0	0	0	1	1
133	1	0	0	0	0	1	0	0
134	1	0	0	0	0	1	0	1
135	1	0	0	0	0	1	1	0
136	1	0	0	0	0	1	1	1
137	1	0	0	0	1	0	0	0
138	1	0	0	0	1	0	0	1
139	1	0	0	0	1	0	1	0
140	1	0	0	0	1	0	1	1
141	1	0	0	0	1	1	0	0
142	1	0	0	0	1	1	0	1
143	1	0	0	0	1	1	1	0
144	1	0	0	0	1	1	1	1
145	1	0	0	1	0	0	0	0
146	1	0	0	1	0	0	0	1
147	1	0	0	1	0	0	1	0
148	1	0	0	1	0	0	1	1
149	1	0	0	1	0	1	0	0
150	1	0	0	1	0	1	0	1
151	1	0	0	1	0	1	1	0
152	1	0	0	1	0	1	1	1
153	1	0	0	1	1	0	0	0
154	1	0	0	1	1	0	0	1
155	1	0	0	1	1	0	1	0
156	1	0	0	1	1	0	1	1
157	1	0	0	1	1	1	0	0
158	1	0	0	1	1	1	0	1
159	1	0	0	1	1	1	1	0
160	1	0	0	1	1	1	1	1
161	1	0	1	0	0	0	0	0
162	1	0	1	0	0	0	0	1
163	1	0	1	0	0	0	1	0

	STATIVE	VOLIT.	AFFECTED	OBJ-EXP	SUBJ-EXP	AGT-PAT	ACTIONAL	TRANS
164	1	0	1	0	0	0	1	1
165	1	0	1	0	0	1	0	0
166	1	0	1	0	0	1	0	1
167	1	0	1	0	0	1	1	0
168	1	0	1	0	0	1	1	1
169	1	0	1	0	1	0	0	0
170	1	0	1	0	1	0	0	1
171	1	0	1	0	1	0	1	0
172	1	0	1	0	1	0	1	1
173	1	0	1	0	1	1	0	0
174	1	0	1	0	1	1	0	1
175	1	0	1	0	1	1	1	0
176	1	0	1	0	1	1	1	1
177	1	0	1	1	0	0	0	0
178	1	0	1	1	0	0	0	1
179	1	0	1	1	0	0	1	0
180	1	0	1	1	0	0	1	1
181	1	0	1	1	0	1	0	0
182	1	0	1	1	0	1	0	1
183	1	0	1	1	0	1	1	0
184	1	0	1	1	0	1	1	1
185	1	0	1	1	1	0	0	0
186	1	0	1	1	1	0	0	1
187	1	0	1	1	1	0	1	0
188	1	0	1	1	1	0	1	1
189	1	0	1	1	1	1	0	0
190	1	0	1	1	1	1	0	1
191	1	0	1	1	1	1	1	0
192	1	0	1	1	1	1	1	1
193	1	1	0	0	0	0	0	0
194	1	1	0	0	0	0	0	1
195	1	1	0	0	0	0	1	0
196	1	1	0	0	0	0	1	1
197	1	1	0	0	0	1	0	0
198	1	1	0	0	0	1	0	1
199	1	1	0	0	0	1	1	0
200	1	1	0	0	0	1	1	1
201	1	1	0	0	1	0	0	0
202	1	1	0	0	1	0	0	1
203	1	1	0	0	1	0	1	0
204	1	1	0	0	1	0	1	1
205	1	1	0	0	1	1	0	0

	STATIVE	VOLIT.	AFFECTED	OBJ-EXP	SUBJ-EXP	AGT-PAT	ACTIONAL	TRANS
206	1	1	0	0	1	1	0	1
207	1	1	0	0	1	1	1	0
208	1	1	0	0	1	1	1	1
209	1	1	0	1	0	0	0	0
210	1	1	0	1	0	0	0	1
211	1	1	0	1	0	0	1	0
212	1	1	0	1	0	0	1	1
213	1	1	0	1	0	1	0	0
214	1	1	0	1	0	1	0	1
215	1	1	0	1	0	1	1	0
216	1	1	0	1	0	1	1	1
217	1	1	0	1	1	0	0	0
218	1	1	0	1	1	0	0	1
219	1	1	0	1	1	0	1	0
220	1	1	0	1	1	0	1	1
221	1	1	0	1	1	1	0	0
222	1	1	0	1	1	1	0	1
223	1	1	0	1	1	1	1	0
224	1	1	0	1	1	1	1	1
225	1	1	1	0	0	0	0	0
226	1	1	1	0	0	0	0	1
227	1	1	1	0	0	0	1	0
228	1	1	1	0	0	0	1	1
229	1	1	1	0	0	1	0	0
230	1	1	1	0	0	1	0	1
231	1	1	1	0	0	1	1	0
232	1	1	1	0	0	1	1	1
233	1	1	1	0	1	0	0	0
234	1	1	1	0	1	0	0	1
235	1	1	1	0	1	0	1	0
236	1	1	1	0	1	0	1	1
237	1	1	1	0	1	1	0	0
238	1	1	1	0	1	1	0	1
239	1	1	1	0	1	1	1	0
240	1	1	1	0	1	1	1	1
241	1	1	1	1	0	0	0	0
242	1	1	1	1	0	0	0	1
243	1	1	1	1	0	0	1	0
244	1	1	1	1	0	0	1	1
245	1	1	1	1	0	1	0	0
246	1	1	1	1	0	1	0	1
247	1	1	1	1	0	1	1	0

	STATIVE	VOLIT.	AFFECTED	OBJ-EXP	SUBJ-EXP	AGT-PAT	ACTIONAL	TRANS
248	1	1	1	1	0	1	1	1
249	1	1	1	1	1	0	0	0
250	1	1	1	1	1	0	0	1
251	1	1	1	1	1	0	1	0
252	1	1	1	1	1	0	1	1
253	1	1	1	1	1	1	0	0
254	1	1	1	1	1	1	0	1
255	1	1	1	1	1	1	1	0
256	1	1	1	1	1	1	1	1

A.5 Materials used in the Novel Verb Learning Study

Table 2: Example script of audio for *doak* (+TRANS, -STATIVE, -AFFECT)

Talker 1	Starting Question	Did you hear?
	(In-) Transitive + (Non-) Stative Frame	Andrew is doaking Mary. He is doaking Mary but nothing happens to her.
	Emphasis on Obj/Subj	Look what Andrew does!
Talker 2	In-Agreement	Oh yeah!
	Emphasis on Obj/Subj	Lucky Mary!
	(In-) Transitive + (Non-) Stative Frame	He is doaking Mary. It's cool when Andrew is doaking Mary.

Table 3: Example script of audio for *pilk* (+TRANS, -STATIVE, -AFFECT)

Talker 1	Starting Question	Did you hear?
	(In-) Transitive + (Non-) Stative Frame	Andrew is pilking Mary. He is pilking Mary but nothing happens to her.
	Emphasis on Obj/Subj	Look what Andrew does!
Talker 2	In-Agreement	Oh yeah!
	Emphasis on Obj/Subj	Lucky Mary!
	(In-) Transitive + (Non-) Stative Frame	He is pilking Mary. It's cool when Andrew is pilking Mary.

Table 4: Example script of audio for *pell* (+TRANS, -STATIVE, +AFFECT)

Talker 1	Starting Question	Did you hear?
	(In-) Transitive + (Non-) Stative Frame	Andrew is pelling Mary. He is pelling Mary and watch her go.
	Emphasis on Obj/Subj	Just look at Mary!
Talker 2	In-Agreement	Oh yeah!
	Emphasis on Obj/Subj	Lucky Mary!
	(In-) Transitive + (Non-) Stative Frame	He is pelling Mary. When he is pelling Mary, watch her go!

Table 5: Example script of audio for *gump* (+TRANS, -STATIVE, +AFFECT)

Talker 1	Starting Question	Did you hear?
	(In-) Transitive + (Non-) Stative Frame	Andrew is gumping Mary. He is gumping Mary and watch her go.
	Emphasis on Obj/Subj	Just look at Mary!
Talker 2	In-Agreement	Oh yeah!
	Emphasis on Obj/Subj	Lucky Mary!
	(In-) Transitive + (Non-) Stative Frame	He is gumping Mary. When he is gumping Mary, watch her go!

Table 6: Example script of audio for *blink* (+TRANS, +STATIVE, +AFFECT)

Talker 1	Starting Question	Did you hear?
	(In-) Transitive + (Non-) Stative Frame	Andrew blinks Mary. He blinks Mary and she feels it.
	Emphasis on Obj/Subj	Just look at Mary!
Talker 2	In-Agreement	Oh yeah!
	Emphasis on Obj/Subj	Lucky Mary!
	(In-) Transitive + (Non-) Stative Frame	He blinks Mary. And ooh, Mary feels it when Andrew blinks her.

Table 7: Example script of audio for *moop* (+TRANS, +STATIVE, +AFFECT)

Talker 1	Starting Question	Did you hear?
	(In-) Transitive + (Non-) Stative Frame	Andrew moops Mary. He moops Mary and she feels it.
	Emphasis on Obj/Subj	Just look at Mary!
Talker 2	In-Agreement	Oh yeah!
	Emphasis on Obj/Subj	Lucky Mary!
	(In-) Transitive + (Non-) Stative Frame	He moops Mary. And ooh, Mary feels it when Andrew moops her.

Table 8: Example script of audio for *gorp* (+TRANS, +STATIVE, -AFFECT)

Talker 1	Starting Question	Did you hear?
	(In-) Transitive + (Non-) Stative Frame	Andrew gorps Mary. Andrew gorps her and he feels it.
	Emphasis on Obj/Subj	Just look at Andrew!
Talker 2	In-Agreement	Oh yeah!
	Emphasis on Obj/Subj	Lucky Andrew!
	(In-) Transitive + (Non-) Stative Frame	Andrew gorps her. And oooooh, Andrew feels it when he gorps Mary.

Table 9: Example script of audio for *keat* (+TRANS, +STATIVE, -AFFECT)

Talker 1	Starting Question	Did you hear?
	(In-) Transitive + (Non-) Stative Frame	Andrew keats Mary. Andrew keats her and he feels it.
	Emphasis on Obj/Subj	Just look at Andrew!
Talker 2	In-Agreement	Oh yeah!
	Emphasis on Obj/Subj	Lucky Andrew!
	(In-) Transitive + (Non-) Stative Frame	Andrew keats her. And oooooh, Andrew feels it when he keats Mary.

Table 10: Example script of audio for *floose* (-TRANS, -STATIVE, +AFFECT)

Talker 1	Starting Question	Did you hear?
	(In-) Transitive + (Non-) Stative Frame	Andrew is floosing. No matter where he goes, Andrew is floosing.
	Emphasis on Obj/Subj	Just Look what Andrew does!
Talker 2	In-Agreement	Oh yeah!
	Emphasis on Obj/Subj	I saw Andrew floosing yesterday!
	(In-) Transitive + (Non-) Stative Frame	When Andrew is by himself, he is floosing the most. Watch Andrew go!

Table 11: Example script of audio for *jape* (-TRANS, -STATIVE, +AFFECT)

Talker 1	Starting Question	Did you hear?
	(In-) Transitive + (Non-) Stative Frame	Andrew is japing. No matter where he goes, Andrew is japing.
	Emphasis on Obj/Subj	Just Look what Andrew does!
Talker 2	In-Agreement	Oh yeah!
	Emphasis on Obj/Subj	I saw Andrew japing yesterday!
	(In-) Transitive + (Non-) Stative Frame	When Andrew is by himself, he is japing the most. Watch Andrew go!

Bibliography

- Alexiadou, A., E. Anagnostopoulou, and F. Schäfer (2015). External Arguments in Transitivity Alternations: A Layering Approach. Oxford University Press. Google-Books-ID: XjFABwAAQBAJ.
- Alexiadou, A., E. Anagnostopoulou, and F. Schäfer (2018). Passive. In N. Hornstein, H. Lasnik, P. Patel-Grosz, and C. Yang (Eds.), Syntactic Structures after 60 Years: The Impact of the Chomskyan Revolution in Linguistics, pp. 403–426. De Gruyter.
- Allen, S. E. and M. B. Crago (1996). Early passive acquisition in Inuktitut. Journal of Child Language 23(1), 129–155. Publisher: Cambridge University Press.
- Ambridge, B., A. Bidgood, J. M. Pine, C. F. Rowland, and D. Freudenthal (2016, August). Is Passive Syntax Semantically Constrained? Evidence From Adult Grammaticality Judgment and Comprehension Studies. Cognitive Science 40(6), 1435–1459.
- Ambridge, B., J. M. Pine, and C. F. Rowland (2011). Children use verb semantics to retreat from overgeneralization errors: A novel verb grammaticality judgment study.
- Anderson, S. (1977). Comments on the paper by Wasow. Formal Syntax, ed. by P. Culicover, T. Wasow, & A. Akmajian, 361–77. New York: Academic Press.
- Babyonyshev, M. and D. Brun (2003). The role of aspect in the acquisition of passive constructions in Russian. GALA. Utrecht, The Netherlands.
- Babyonyshev, M., J. Ganger, D. Pesetsky, and K. Wexler (2001). The maturation of grammatical principles: Evidence from Russian unaccusatives. Linguistic inquiry 32(1), 1–44. Publisher: MIT Press.
- Baker, M. (1988). Incorporation: A theory of grammatical function changing. Chicago, IL: University of Chicago Press.
- Baker, M., K. Johnson, and I. Roberts (1989). Passive Arguments Raised. Linguistic Inquiry 20(2), 219–251.
- Bartke, S. (2004, June). Passives in German children with WS. In S. Bartke and J. Siegmüller (Eds.), Williams Syndrome across Languages. Amsterdam/Philadelphia: John Benjamins Publishing.
- Becker, M. and K. U. Deen (2020). Language Acquisition and Development: A Generative Introduction. MIT Press.
- Beilin, H. (1975). Studies in the cognitive basis of language development. Academic Press.
- Belletti, A. and L. Rizzi (1988). Psych-verbs and theta-theory. Natural Language & Linguistic Theory 6(3), 291–352. Publisher: Springer.

- Berman, R. A. (1985). The acquisition of Hebrew. The cross-linguistic study of language acquisition 1, 255–371.
- Bever, T. G. (1970). The cognitive basis for linguistic structures. Cognition and the development of language 279(362), 1–61.
- Bobaljik, J. D. (2012). Universals in comparative morphology: Suppletion, superlatives, and the structure of words. MIT Press.
- Bolinger, D. (1977). Transitivity and spatiality: The passive of prepositional verbs. Linguistics at the Crossroads, 57–78. Publisher: Liviana Editrice, Padova and Jupiter Press Lake Bluff, Illinois.
- Booth, J. R., B. Mac Whinney, and Y. Harasaki (2000). Developmental differences in visual and auditory processing of complex sentences. Child Development 71(4), 981–1003.
- Borer, H. and K. Wexler (1987). The maturation of syntax. In Parameter setting, pp. 123–172. Springer.
- Borer, H. and K. Wexler (1992). Bi-unique relations and the maturation of grammatical principles. Natural Language & Linguistic Theory 10(2), 147–189. Publisher: Springer.
- Borga, J. and W. Snyder (2018a). Acquisition of French Causatives: Parallels to English Passives. Languages 3(2), 18. Publisher: Multidisciplinary Digital Publishing Institute.
- Borga, J. and W. Snyder (2018b). French experiencer verbs and the universal freezing hypothesis. On the acquisition of the syntax of romance, 7–29.
- Bowerman, M. (1982). Reorganizational processes in lexical and syntactic development. In Language acquisition: The state of the art, pp. 319–346. Academic Press.
- Bowerman, M. (1988). The ‘no negative evidence’ problem: How do children avoid constructing an overly general grammar? In Explaining language universals, pp. 73–101. Basil Blackwell.
- Bresnan, J. (1982). The Passive in Lexical Theory. In The Mental Representation of Grammatical Relations. Cambridge, MA: MIT Press.
- Brown, R. (1973). A first language: The early stages. Cambridge, MA: Harvard U. Press.
- Bruening, B. (2014). Word formation is syntactic: Adjectival passives in English. Natural Language & Linguistic Theory 32(2), 363–422. Publisher: Springer.
- Budwig, N. (1990). The linguistic marking of nonprototypical agency: An exploration into children’s use of passives. Publisher: Walter de Gruyter, Berlin/New York Berlin, New York.
- Budwig, N. (2001). An exploration into children’s use of passives. Language development: The essential readings, 227–247. Publisher: Blackwell Publishers Malden, MA.

- Burzio, L. (1981). Intransitive verbs and Italian auxiliaries. PhD Dissertation, MIT.
- Chomsky, N. (1957). Syntactic structures. The Hague, The Netherlands: Mouton de Gruyter.
- Chomsky, N. (1965). Aspects of the Theory of Syntax. MIT press.
- Chomsky, N. (1980). Rules and Representations. Oxford: Basil Blackwell.
- Chomsky, N. (1981). Lectures on government and binding. Dordrecht, The Netherlands: Foris.
- Chomsky, N. (1995). The minimalist program. MIT press.
- Chomsky, N. (2000). Minimalist inquiries: The framework (MITOPL 15). Step by step: Essays on minimalist syntax in honor of Howard Lasnik, 89–155. Publisher: MIT press.
- Chouinard, M. M. and E. V. Clark (2003). Adult reformulations of child errors as negative evidence. Journal of child language 30(3), 637–669.
- Clark, E. V. (1982). The young word maker: A case study of innovation in the child's lexicon. Language acquisition: The state of the art, 390–425. Publisher: Cambridge University Press New York.
- Clark, E. V. (2010). Adult offer, word-class, and child uptake in early lexical acquisition. First Language 30(3-4), 250–269.
- Collins, C. (2005a, April). A Smuggling Approach to Raising in English. Linguistic Inquiry 36(2), 289–298.
- Collins, C. (2005b). A smuggling approach to the passive in English. Syntax 8(2), 81–120. Publisher: Wiley Online Library.
- Costa, J. and N. Friedmann (2012). Children acquire unaccusatives and A-movement very early. The theta system: Argument structure at the interface (37), 354. Publisher: Oxford University Press.
- Crain, S. (1991). Language acquisition in the absence of experience. Behavioral and Brain Sciences 14(4), 597–612. Publisher: Cambridge University Press.
- Crain, S. and J. Fodor (1989). Competence and performance in child language. Haskins Laboratories report on speech research 100, 118–136.
- Crain, S. and C. McKee (1985). The acquisition of structural restrictions on anaphora. In Proceedings of NELS, Volume 15, pp. 94–110.
- Crain, S. and R. Thornton (1998). Investigations in Universal Grammar: A guide to research on the acquisition of syntax and semantics. Cambridge, MA: MIT Press.
- Crain, S. and R. Thornton (2000). Investigations in universal grammar: A guide to experiments on the acquisition of syntax and semantics. MIT Press.

- Crain, S., R. Thornton, C. Boster, L. Conway, D. Lillo-Martin, and E. Woodams (1996). Quantification without qualification. Language Acquisition 5(2), 83–153.
- Crain, S., R. Thornton, and K. Murasugi (2009). Capturing the evasive passive. Language Acquisition 16(2), 123–133. Publisher: Taylor & Francis.
- Crawford, J. (2005). An adversity passive analysis of early Sesotho passives: Reanalyzing a counterexample to maturation. Proceedings Supplement of BUCLD 29.
- Crawford, J. L. (2012). Developmental perspectives on the acquisition of the passive. University of Connecticut.
- De Villiers, J. G. (1984). Learning the passive from models: Some contradictory data. In 9th annual Boston University Conference on Language Development, Boston, MA.
- de Villiers, J. G. and P. A. de Villiers (1973). Development of the use of word order in comprehension. Journal of Psycholinguistic Research 2(4), 331–341. Publisher: Springer.
- Deen, K., I. Bondoc, A. Camp, S. Estioca, H. Hwang, G.-H. Shin, M. Takahashi, F. Zenker, and J. Zhong (2018). Repetition brings success: Revealing knowledge of the passive voice. In Proceedings of the 42nd Annual Boston University Conference on Language Development, pp. 200–213.
- Demuth, K. (1989). Maturation and the Acquisition of the Sesotho Passive. Language 65(1), 56–80.
- Demuth, K., F. Moloi, and M. Machobane (2010, May). 3-Year-olds' comprehension, production, and generalization of Sesotho passives. Cognition 115(2), 238–251.
- Ehrenhofer, L. M. I. (2018). Argument roles in adult and child comprehension. Ph. D. thesis, University of Maryland, College Park.
- Feldman, N. (2011). Interactions between word and speech sound categorization in language acquisition. PhD Dissertation, Brown University.
- Feldman, N., T. Griffiths, and J. Morgan (2009). Learning phonetic categories by learning a lexicon. In Proceedings of the Annual Meeting of the Cognitive Science Society, Volume 31. Issue: 31.
- Feldman, N. H., T. L. Griffiths, S. Goldwater, and J. L. Morgan (2013). A role for the developing lexicon in phonetic category acquisition. Psychological review 120(4), 751. Publisher: American Psychological Association.
- Feng, S., J. Legault, L. Yang, J. Zhu, K. Shao, and Y. Yang (2015). Differences in grammatical processing strategies for active and passive sentences: An fMRI study. Journal of Neurolinguistics 33, 104–117. Publisher: Elsevier.
- Fodor, J. D. (1998). Parsing to learn. Journal of Psycholinguistic research 27(3), 339–374.

- Foraker, S., T. Regier, N. Khetarpal, A. Perfors, and J. Tenenbaum (2009). Indirect evidence and the poverty of the stimulus: The case of anaphoric one. Cognitive Science 33(2), 287–300. Publisher: Wiley Online Library.
- Forsythe, H. and L. Pearl (2020). Immature representation or immature deployment? modeling child pronoun resolution. In Proceedings of the Society for Computation in Linguistics 2020, pp. 20–21.
- Fox, D. and Y. Grodzinsky (1998). Children’s passive: a view from the by-phrase. Linguistic Inquiry 29(2), 311–332. Publisher: MIT Press.
- Frank, M. C., N. D. Goodman, and J. B. Tenenbaum (2009). Using speakers’ referential intentions to model early cross-situational word learning. Psychological science 20(5), 578–585. Publisher: SAGE Publications Sage CA: Los Angeles, CA.
- Friederici, A. D., K. Steinhauer, A. Mecklinger, and M. Meyer (1998). Working memory constraints on syntactic ambiguity resolution as revealed by electrical brain responses. Biological psychology 47(3), 193–221.
- Gagliardi, A., N. H. Feldman, and J. Lidz (2012). When suboptimal behavior is optimal and why: Modeling the acquisition of noun classes in Tsez. In Proceedings of the Cognitive Science Society, Volume 34. Issue: 34.
- Gagliardi, A., N. H. Feldman, and J. Lidz (2017). Modeling statistical insensitivity: Sources of suboptimal behavior. Cognitive science 41(1), 188–217. Publisher: Wiley Online Library.
- Gagliardi, A., T. M. Mease, and J. Lidz (2016, July). Discontinuous development in the acquisition of filler-gap dependencies: Evidence from 15- and 20-month-olds. Language Acquisition 23(3), 234–260.
- Gazdar, G., E. Klein, G. K. Pullum, and I. A. Sag (1985). Generalized phrase structure grammar. Harvard University Press.
- Gehrke, B. and N. Grillo (2009). How to become passive. Explorations of phase theory: Features, arguments, and interpretation at the interfaces, 231–268. Publisher: Interface Explorations.
- Gleitman, L. R. (1981). Maturational determinants of language growth. Cognition 10, 103–114. Publisher: Elsevier Science.
- Goldwater, S., T. L. Griffiths, and M. Johnson (2009). A Bayesian framework for word segmentation: Exploring the effects of context. Cognition 112(1), 21–54. Publisher: Elsevier.
- Goldwater, S. J. (2007). Nonparametric Bayesian Models of Lexican Acquisition. PhD Dissertation, Brown University.

- Gordon, P. and J. Chafetz (1990). Verb-based versus class-based accounts of actionality effects in children's comprehension of passives. Cognition 36(3), 227–254. Publisher: Elsevier.
- Gotowski, M. (2019). The acquisition of the get-passive. Language Acquisition 26(1), 1–20. Publisher: Taylor & Francis.
- Grillo, N. (2008). Generalized Minimality: Syntactic underspecification in Broca's aphasia. PhD Dissertation, Utrecht University.
- Grimshaw, J. (1990). Argument structure. the MIT Press.
- Guasti, M. T. (2002). Language acquisition: The growth of grammar. MIT press.
- Guasti, M. T. (2017). Language acquisition: The growth of grammar. MIT press.
- Haegeman, L. (1994). Introduction to government and binding theory. Wiley-Blackwell.
- Harris, F. N. and J. A. Flora (1982). Children's use of Get-passives. Journal of Psycholinguistic Research 11(4), 297–311. Publisher: Springer.
- Hirotsani, M., M. Makuuchi, S.-A. Rüschemeyer, and A. D. Friederici (2011). Who was the agent? The neural correlates of reanalysis processes during sentence comprehension. Human Brain Mapping 32(11), 1775–1787. Publisher: Wiley Online Library.
- Hirsch, C. and J. Hartman (2006). Some (wh-) questions concerning passive interactions. In Proceedings of the Conference on Generative Approaches to Language Acquisition. Cambridge Scholars Press. Newcastle.
- Hirsch, C. and K. Wexler (2006). Children's passives and their resulting interpretation. In The proceedings of the inaugural conference on generative approaches to language acquisition—North America, University of Connecticut Occasional Papers in Linguistics, Volume 4, pp. 125–136.
- Hopper, P. J. and S. A. Thompson (1980). Transitivity in grammar and discourse. language, 251–299. Publisher: JSTOR.
- Horgan, D. (1978). The development of the full passive. Journal of Child Language 5(01), 65–80. Publisher: Cambridge Univ Press.
- Huang, Y. T., X. Zheng, X. Meng, and J. Snedeker (2013, November). Children's assignment of grammatical roles in the online processing of Mandarin passive sentences. Journal of Memory and Language 69(4), 589–606.
- Hyams, N., D. Ntelitheos, and C. Manorohanta (2006). Acquisition of the malagasy voicing system: implications for the adult grammar. Natural Language & Linguistic Theory 24(4), 1049–1092.
- Hyams, N. and W. Snyder (2006). Young children are frozen: Reflexive clitics and the Universal Freezing Hypothesis. Ms. UCLA/UConn.

- Jaeggli, O. A. (1986). Passive. Linguistic inquiry, 587–622.
- Keenan, E. L. and M. S. Dryer (1981). Passive in the world's languages. Linguistic Agency, University of Trier.
- Kemp, C., A. Perfors, and J. B. Tenenbaum (2007). Learning overhypotheses with hierarchical bayesian models. Developmental science 10(3), 307–321.
- Kimenyi, A. (1980). A relational grammar of Kinyarwanda, Volume 91. Univ of California Press.
- Landau, I. (2002). A typology of psych passives. In North East Linguistics Society, Volume 32, pp. 17. Issue: 1.
- Landau, I. (2010). The Locative Syntax of Experiencers, LI Monograph 53. MIT Press.
- Lany, J. and R. L. Gómez (2008). Twelve-month-old infants benefit from prior experience in statistical learning. Psychological Science 19(12), 1247–1252.
- Lau, E. (2011). Obligatory agent promotes cue validity: Early acquisition of passive in Cantonese. In Proceedings of the 35th annual Boston University Conference on Language Development, pp. 382–390.
- Levin, B. (1993). English verb classes and alternations: A preliminary investigation. University of Chicago press.
- Levin, B. and M. Rappaport (1986). The formation of adjectival passives. Linguistic inquiry, 623–661. Publisher: JSTOR.
- Levy, R. and G. Andrew (2006). Tregex and Tsurgeon: tools for querying and manipulating tree data structures. In LREC, pp. 2231–2234. Citeseer.
- Lidz, J. and A. Gagliardi (2015). How nature meets nurture: Universal grammar and statistical learning. Annual Review Linguistics 1(1), 333–353. Publisher: Annual Reviews.
- Lightfoot, D. (1989). The child's trigger experience: Degree-0 learnability. Behavioral and Brain Sciences 12(2), 321–334. Publisher: Cambridge University Press.
- Liter, A., T. Huelskamp, S. Weerakoon, and A. Munn (2015). What drives the Maratsos Effect, agentivity or eventivity? In Boston University Conference on Language Development (BUCLD), Boston University, Boston, MA.
- Liter, A. and J. Lidz (2020). Non-actional passives can be comprehended by 4-year olds. In Boston University Conference on Language Development (BUCLD), Boston University, Boston, MA.
- Mack, J. E., A. Meltzer-Asscher, E. Barbieri, and C. K. Thompson (2013). Neural correlates of processing passive sentences. Brain Sciences 3(3), 1198–1214. Publisher: Multidisciplinary Digital Publishing Institute.

- MacWhinney, B. (2000). The CHILDES project: The database, Volume 2. Psychology Press.
- Maratsos, M., D. E. Fox, J. A. Becker, and M. A. Chalkley (1985). Semantic restrictions on children's passives. Cognition 19(2), 167–191. Publisher: Elsevier.
- Maratsos, M. P. and R. Abramovitch (1975). How children understand full, truncated, and anomalous passives. Journal of Verbal Learning and Verbal Behavior 14(2), 145–157. Publisher: Elsevier.
- Marchman, V. A., E. Bates, A. Burkardt, and A. B. Good (1991). Functional constraints of the acquisition of the passive: Toward a model of the competence to perform. First language 11(31), 65–92. Publisher: Sage Publications Sage CA: Thousand Oaks, CA.
- Menyuk, P. (1963). Syntactic structures in the language of children. Child Development, 407–422. Publisher: JSTOR.
- Messenger, K., H. P. Branigan, and J. F. McLean (2011, November). Evidence for (shared) abstract structure underlying children's short and full passives. Cognition 121(2), 268–274.
- Messenger, K., H. P. Branigan, J. F. McLean, and A. Sorace (2012). Is young children's passive syntax semantically constrained? Evidence from syntactic priming. Journal of Memory and Language 66(4), 568–587. Publisher: Elsevier.
- Mills, A. E. (1985). The acquisition of German. The cross-linguistic study of language acquisition 1, 141–254.
- Mintz, T. H. (2006). Finding the verbs: Distributional cues to categories available to young learners. Action meets word: How children learn verbs 31, 63.
- Newport, E. L. and R. N. Aslin (2004). Learning at a distance i. statistical learning of non-adjacent dependencies. Cognitive psychology 48(2), 127–162.
- Nguyen, E. (2015). Felicity of the by-phrase is not enough: Re-evaluating O'Brien et al. (2006).
- Nguyen, E., D. Lillo-Martin, and W. Snyder (2018). Actionality Speaks Louder Than Felicity: English-Speaking Children's Comprehension of Passives. Language Acquisition at the Interfaces: Proceedings of GALA 2015, 232–246. Publisher: Cambridge Scholars Publishing.
- Nguyen, E. and L. Pearl (2018). Do you really mean it? Linking lexical semantic profiles and the age of acquisition for the English passive. In The Proceedings of the 35th West Coast Conference on Formal Linguistics, pp. 288–295.
- Nguyen, E. and L. Pearl (2019). Using Developmental Modeling to Specify Learning and Representation of the Passive in English Children. In Proceedings of the 43rd Annual Boston University Conference on Language Development, pp. 469–482.

- Nguyen, E. and L. Pearl (2021). The link between lexical semantic features and children's comprehension of english verbal *be*-passives. Language Acquisition.
- Nguyen, E. and W. Snyder (2017). The (Non-) Effects of Pragmatics on Children's Passives. In Proceedings of the 41st Annual Boston University Conference on Language Development, pp. 522–531.
- O'Brien, K., E. Grolla, and D. Lillo-Martin (2006). Long passives are understood by young children. In In the proceedings of the Boston University Conference on Language Development (BUCLD), Volume 30, pp. 441–451.
- Omaki, A. and J. Lidz (2015). Linking parser development to acquisition of syntactic knowledge. Language Acquisition 22(2), 158–192. Publisher: Taylor & Francis.
- Orfitelli, R. M. (2012). Argument intervention in the acquisition of A-movement. University of California, Los Angeles.
- Pearl, L. (2020). Modeling syntactic acquisition. The Oxford Handbook of Experimental Syntax.
- Pearl, L. and S. Goldwater (2016). Statistical learning, inductive bias, and Bayesian inference in language acquisition. Publisher: Citeseer.
- Pearl, L. and J. Lidz (2009). When domain-general learning fails and when it succeeds: Identifying the contribution of domain specificity. Language Learning and Development 5(4), 235–265. Publisher: Taylor & Francis.
- Pearl, L. and J. Lidz (2013). Parameters in language acquisition. The Cambridge handbook of biolinguistics, 129–159.
- Pearl, L. and J. Sprouse (2013). Syntactic islands and learning biases: Combining experimental syntax and computational modeling to investigate the language acquisition problem. Language Acquisition 20(1), 23–68. Publisher: Taylor & Francis.
- Pearl, L. and A. Weinberg (2007). Input filtering in syntactic acquisition: Answers from language change modeling. Language Learning and Development 3(1), 43–72. Publisher: Taylor & Francis.
- Pearl, L. S. (2021). How statistical learning can play well with universal grammar. A Companion to Chomsky, 267–286.
- Pearl, L. S. and B. Mis (2016). The role of indirect positive evidence in syntactic acquisition: A look at anaphoric one. Language 92(1), 1–30. Publisher: Linguistic Society of America.
- Perfors, A., J. B. Tenenbaum, and T. Regier (2011). The learnability of abstract syntactic principles. Cognition 118(3), 306–338. Publisher: Elsevier.

- Perfors, A., J. B. Tenenbaum, and E. Wonnacott (2010). Variability, negative evidence, and the acquisition of verb argument constructions. Journal of child language 37(3), 607–642. Publisher: Cambridge University Press.
- Perkins, L. and J. Lidz (2020, January). Filler-gap dependency comprehension at 15 months: The role of vocabulary. Language Acquisition 27(1), 98–115.
- Pesetsky, D. (1995). Zero Syntax: Experiencers and Cascades. Cambridge, MA: The MIT Press.
- Pierce, A. E. (1992, January). The Acquisition of Passives in Spanish and the Question of A-Chain Maturation. Language Acquisition 2(1), 55–81.
- Pinker, S. (1989). Learnability and cognition: The acquisition of argument structure. Cambridge, MA: The MIT Press.
- Pinker, S., D. S. Lebeaux, and L. A. Frost (1987, August). Productivity and constraints in the acquisition of the passive. Cognition 26(3), 195–267.
- Regier, T. and S. Gahl (2004). Learning the unlearnable: The role of missing evidence. Cognition 93(2), 147–155. Publisher: Elsevier.
- Rizzi, L. (1990). Relativized minimality. The MIT Press.
- Rizzi, L. (1993). Some notes on linguistic theory and language development: The case of root infinitives. Language acquisition 3(4), 371–393. Publisher: Taylor & Francis.
- Rizzi, L. (2001). Relativized minimality effects. The handbook of contemporary syntactic theory 4, 89–110. Publisher: Wiley Online Library.
- Rizzi, L. (2004). Locality and left periphery. Structures and beyond: The cartography of syntactic structures 3, 223–251.
- Saffran, J. R., E. L. Newport, and R. N. Aslin (1996). Word segmentation: The role of distributional cues. Journal of memory and language 35(4), 606–621.
- Sinclair, A., H. Sinclair, and O. De Marcelus (1971). Young children’s comprehension and production of passive sentences. Archives de psychologie. Publisher: Editions Médecine et Hygiène.
- Smith, L. and C. Yu (2008). Infants rapidly learn word-referent mappings via cross-situational statistics. Cognition 106(3), 1558–1568.
- Snyder, W. and N. Hyams (2015). Minimality effect in children’s passives. Elisa Di Domenico, Cornelia Hamann and Simona Matteini. Structures, Strategies and Beyond: Studies in honour of Adriana Belletti, 343–368.
- Snyder, W., N. Hyams, and P. Crisma (1995). Romance auxiliary selection with reflexive clitics: Evidence for early knowledge of unaccusativity. In Proceedings of the 26th annual child language research forum, pp. 127–136. Stanford, CA CSLI Publications.

- Snyder, W. and K. Stromswold (1997). The structure and acquisition of English dative constructions. Linguistic Inquiry, 281–317. Publisher: JSTOR.
- Stromswold, K., J. Eisenband, E. Norland, and J. Ratzan (2002). Tracking the acquisition and processing of English passives: Using acoustic cues to disambiguate actives and passives. In CUNY conference on sentence processing, Volume 2123.
- Sudhalter, V. and M. D. Braine (1985). How does comprehension of passives develop? A comparison of actional and experiential verbs. Journal of child language 12(2), 455–470. Publisher: Cambridge University Press.
- Sugisaki, K. and M. Isobe (2001). Quantification without qualification without plausible dissent. University of Massachusetts Occasional Papers in Linguistics 25, 97–100.
- Svartvik, J. (1966). On Voice in the English Verb (The Hague). The Netherlands: Mouton and Co.
- Tomasello, M. (1992). First verbs: A case study of early grammatical development. Cambridge University Press.
- Travis, L. (2000). Event structure in syntax. Events as grammatical objects: The converging perspectives of lexical semantics and syntax 145, 185.
- Trueswell, J. C., I. Sekerina, N. M. Hill, and M. L. Logrip (1999). The kindergarten-path effect: Studying on-line sentence processing in young children. Cognition 73(2), 89–134. Publisher: Elsevier.
- Turner, E. A. and R. Rommetveit (1967). Experimental manipulation of the production of active and passive voice in children. Language and Speech 10(3), 169–180. Publisher: Sage Publications Sage CA: Thousand Oaks, CA.
- Valian, V. (1991). Syntactic subjects in the early speech of American and Italian children. Cognition 40(1), 21–81. Publisher: Elsevier.
- Vendler, Z. (1957). Verbs and times. The Philosophical Review 66, 143–160.
- Verrips, M. (1996). Potatoes must peel. The acquisition of the Dutch passive. Publisher: DordrechtICG printing.
- Wasow, T. (1977). Transformations and the lexicon. Formal syntax, 327–360. Publisher: Academic Press.
- Wexler, K. (1991). On the argument from the poverty of the stimulus. In The Chomskyan Turn, pp. 252–270. Oxford: Basil Blackwell.
- Wexler, K. (1994). Optional infinitives, head movement and the economy of derivations1. Verb movement, 305–350. Publisher: Cambridge University Press.
- Wexler, K. (1996). The development of inflection in a biologically based theory of language acquisition. Toward a genetics of language, 113–144.

Williams, E. (1980). Predication. Linguistic Inquiry 11(1), 203–238. Publisher: The MIT Press.

Xu, F. and J. B. Tenenbaum (2007). Word learning as Bayesian inference. Psychological review 114(2), 245. Publisher: American Psychological Association.

Yuan, S. and C. Fisher (2009). “really? she blicked the baby?” two-year-olds learn combinatorial facts about verbs by listening. Psychological science 20(5), 619–626.