

CONDITIONAL CONSTRUCTIONS IN A'INGAE

MAKSYMILIAN DĄBKOWSKI

UNIVERSITY OF CALIFORNIA, BERKELEY

MANUSCRIPT *as of* JUNE 20, 2022

1	INTRODUCTION	1
2	LANGUAGE BACKGROUND	2
3	NEUTRAL CONDITIONALS	3
3.1	<i>If</i> -complementizers	3
3.2	Reality marking	5
3.3	CxG formalization	7
4	DISTANCED CONDITIONALS	13
4.1	Description	13
4.2	Simulative marking	14
4.3	GxC formalization	17
5	CONCLUSIONS	19

ABSTRACT. I describe and analyze conditional constructions in A'ingae (or Cofán, iso 639-3: con), an indigenous language isolate of the Amazon. In addition to compositional and non-compositional properties, A'ingae conditionals have properties that straddle the line between the two extremes, reusing formal devices or reimplementing semantic distinctions which exist in other parts of the grammar. I provide a constructional analysis of the data and argue that it can accommodate the idiosyncrasies of A'ingae conditionals, while capturing the semantic and formal generalization at all the relevant levels.

Finally, negative epistemic stance in conditional constructions is encoded using a simulative morpheme. The primary function of the simulative is to express qualitative comparison. I observe that comparison requires considering a distanced mental space. I argue that in distanced conditionals, the simulative has undergone semantic bleaching to convey mental space distance only.

1 INTRODUCTION

In this paper, I describe and analyze conditional constructions in A'ingae (or Cofán, iso 639-3: con), an indigenous language isolate of the Amazon.

The properties of A'ingae conditionals range from fully compositional to fully construction specific. For example, the lexical content of the conditional is fully compositional, while the complementizers which introduce conditional antecedents are specific to conditional sentences. Other properties of the conditionals straddle the line between the two extremes: They recruit formal devices from other parts of the grammar to play a related role in the conditional construction, or implement semantic distinctions which exist in other parts of the grammar with formally unrelated means.

I provide an analysis of A'ingae conditionals in Construction Grammar (henceforth CxG; Fillmore and Kay, 1996; Fillmore, Kay, and O'Connor, 1988; Goldberg, 2006). I argue that a constructional

analysis is able to accommodate the idiosyncrasies of A'ingae conditionals, while capturing the semantic and formal generalization at all the relevant levels.

Finally, negative epistemic stance in conditional constructions is encoded using a simulative morpheme. The primary function of the simulative is to express qualitative comparison. I observe that comparison requires considering a distanced mental space. I argue that in distanced conditionals, the simulative has undergone semantic bleaching to convey mental space distancing only.

The rest of the paper is structured as follows. [Section 2](#) provides background on the language. [Section 3](#) describes and analyzes neutral conditionals. [Section 4](#) describes and analyzes distanced conditionals. [Section 5](#) concludes.

2 LANGUAGE BACKGROUND

A'ingae (or Cofán, iso 639-3: con) is an indigenous language isolate spoken by ca. 1,500 Cofán people in northeast Ecuador and southern Colombia at the interface of the Andes and the Amazon. The language is believed to be an isolate despite prior claims of affiliation with Barbacoan, Chibchan, and Chicham (AnderBois et al., 2019; Dąbkowski, 2021).

A'ingae is endangered and highly underdocumented. In Ecuador, A'ingae is spoken robustly in all domains of life in a dozen or so Cofán communities and transmitted to children. Despite political, ecological, and economic forces impinging on the Cofán people, they retain a strong sense of ethnic identity and take pride in their linguistic heritage (Dąbkowski, 2021).

A'ingae is an agglutinating language. In matrix clauses, word order is largely free, whereas finite subordinate clauses are strictly verb-final. Functional categories are expressed with suffixes and enclitics; prefixes and proclitics are absent. Verbs are richly inflected, including categories such as voice, aspect, associated motion, number, modality, polarity, force, and others (1).¹

- (1) *Kufe'jengi'fayambitsû.*
kufe -'je -ngi -'fa -ya -mbi =tsû
 play -IPFV -VEN -PLS -IRR -NEG =3
 "They_{3,PLS} will_{IRR} not_{NEG} come_{VEN} to be_{IPFV} playing."

Verbal dependents are marked for case in a nominative-accusative alignment. Case is expressed with clitics. Case clitics follow the noun phrase, within which word order is free (2). The language displays extensive pro-drop, with both subjects and objects omitted if contextually recoverable.

- (2) a. *Rande tsa'uma athe.*
rande tsa'u =ma athe
 large house =ACC see
 "(S/he) saw a large house."
 b. *Tsa'u randema athe.*
tsa'u rande =ma athe
 house large =ACC see
 "(S/he) saw a large house."

¹ The following glossing abbreviations are used: 1 = first person, 2 = second person, 3 = third person, ACC = accusative, ACC2 = accusative 2, ADD = additive, ADV = adverbial, AND = andative, ANM = animate, ATTR = attributive, AUX = auxiliary, COM = comitative, DS = different subject, FUT = future, IF = conditional, INF = infinitive, IPFV = imperfective, IRR = irrealis, MTN.M = manner of motion, NEG = negative, PL = plural, PLS = plural subject, PST = past, RPRT = reportative, SBRD = subordinator, SG = singular, SML = simulative, SS = same subject, VEN = venitive, YNQ = polar interrogative.

There are five sentence-level clitics in *A'ingae*. They appear in the second position of the matrix clause. Three of them encode matrix subject features: first person *=ngi* 1, second person *=ki* 2, and third person *=tsû* 3. The other two clitics encode reportative evidentiality *=te* RPRT, and polar questions *=ti* YNQ. “Second-position” is understood as the position immediately following the first full constituent. Thus, a second-position clitic may surface right-adjacent to a full subordinate clause (3). The subordinate clause is delimited with square brackets [].

- (3) *Ke kunda'chumangi pañambi.*
 [ke (**=ngi* / **=ki*) kunda-'chu]=ma *=ngi* paña-mbi
 2SG (**=1* / **=2*) tell-SBRD=ACC =1 understand-NEG
 “I didn’t understand what you said.”

The data used in this paper come from elicitations with speakers from the three Ecuadorian communities of Zábalo, Dureno, and Sinangoé and from existing publications. Data from existing publications are cited as such. All the data represent the Ecuadorian language variety.

3 NEUTRAL CONDITIONALS

Conditional constructions involve two full clauses: the antecedent, which states the premise, and the consequent, which states the conclusion. In English, the antecedent is headed by the complementizer *if*. The consequent may be introduced with *then* (4).

- (4) *If I hunt a tapir, (then) I will be happy.*

The conditional above is neutral, which means that it does not express a positive or negative epistemic stance towards the scenario it describes. This section describes and analyzes neutral conditionals in *A'ingae*. Section 3.1 focuses on the complementizers which introduce conditional antecedents. Section 3.2 focuses on the reality marking in conditional sentences. Section 3.3 presents a constructional formalization of the data.

3.1 *If*-complementizers

In *A'ingae*, the antecedent is headed by one of two complementizer suffixes: *-’ta* IF.SS² or *-’ni* IF.DS. The consequent is not introduced by any particle; it is a regular matrix clause. The suffix *-’ta* IF.SS is used when the subject of the antecedent is the same as the subject of the consequent (5). The co-indexation on the two instances of “s/he_x” in the translation for (5c) indicates that subject of the antecedent is the same individual as the subject of the consequent.

- (5) SAME-SUBJECT CONDITIONALS
 a. *Khuvima panza’tangi, avûjatshiya.*
khuvi=ma panza -’ta =ngi avûjatshi-ya
 tapir=ACC hunt -IF.SS =1 happy-IRR
 “If I hunt a tapir, I will be happy.”

2 After nasal vowels, the same subject antecedent marker is realized as *-’nda* IF.SS.

- b. *Ke khuvima panza'taki, avûjatshiya.*
ke khuvi=ma panza -'ta -ki avûjatshi-ya
 2SG tapir=ACC hunt -IF.SS =2 happy-IRR
 "If you hunt a tapir, you will be happy."
- c. *Tise khuvima panza'tatsû, avûjatshiya.*
tise khuvi=ma panza -'ta -tsû avûjatshi-ya
 3SG tapir=ACC hunt -IF.SS =3 happy-IRR
 "If s/he_x hunts a tapir, s/he_x will be happy."

The subject of the antecedent and the subject of the consequent may optionally be expressed with a full noun phrase or a pronoun (*ñã* 1SG, *ke* 2SG, *tise* 3SG). In addition, the subject of the consequent (the matrix clause) may optionally be expressed with a second-position clitic (*=ngi* 1, *=ki* 2, *=tsû* 3). Unexpressed arguments are subject to contextual interpretation. However, when the antecedent is headed by *-ta* IF.SS, the subjects of the two clauses must refer to the same individual.

The suffix *-ni* IF.DS is used when the subject of the antecedent is different from the subject of the consequent (6). The different indices on "brother_x" and "s/he_y" in the translation for (6b) indicate that subject of the antecedent must be a different individual from the subject of the consequent.

(6) DIFFERENT SUBJECT CONDITIONALS

- a. *Tise khuvima fi'thi'ni, avûjatshiya.*
tise khuvi=ma fi'thi -'ni avûjatshi-ya
 3SG tapir=ACC kill -IF.DS happy-IRR
 "If s/he kills a tapir, I will be happy."
- b. *Ñã antian khuvima panza'nitsû, avûjatshiya.*
ñã antian khuvima panza -'ni -tsû avûjatshi-ya
 1SG brother tapir=ACC hunt -IF.DS =3 happy-IRR
 "If my brother_x hunts tapir, s/he_y will be happy."
- c. *Ûnjin tûi'ningi, ñukimbitshiya.*
ûnjin tûi -'ni =ngi ñukimbitshi-ya
 rain splash -IF.DS =1 sad-IRR
 "If it rains, I'm sad."

The same-subject complementizer *-ta* IF.SS cannot be used when the subject of the antecedent is different from the subject of the consequent (7a). Likewise, the different-subject *-ni* IF.DS cannot be used when the subject of the antecedent is the same as the subject of the consequent (7b).

(7) UNGRAMMATICAL COMBINATIONS

- a. **Tise khuvima panza'ta, ñã avujatshiya.*
 **tise khuvi=ma panza -'ta ñã avujatshi-ya*
 3SG tapir=ACC hunt -IF.SS 1SG happy-IRR
 intended: "If he hunts tapir, I will be happy."

- b. **Ña khuvima panza'ningi, avûjatshiya.*
 **ña khuvi=ma panza -'ni =ngi avûjatshi-ya*
 1SG tapir=ACC hunt -IF.DS =1 happy-IRR
 intended: "If I hunt a tapir, I will be happy."

Intriguingly, the distinction between same- and different-subject marking in conditional constructions parallels A'ingae reference-tracking system in clause-chaining constructions. In clause-chaining constructions, clauses are marked with the same-subject suffix *-pa ss* if followed by a clause with the same subject, and with the different-subject *-si ds* if followed by a clause with a different subject.

Due to extensive pro-drop, A'ingae clauses may consist solely of the main predicate if the participants are contextually recoverable. This may give rise to multi-clausal sentences where participant tracking is achieved solely through same- and different-subject marking. The story fragment in (8) describes an interaction between a hunter and a tapir. Once the two participants have been established, they need not be overtly expressed; *-pa ss* and *-si ds* alert the reader as to the identity of the subject.

(8) CLAUSE-CHAINING

Atheпа pu'taensi bûthuin ja.

(Borman, 1980, p. 8)

athe-pa pu'taen-si bûthu-in ja

see-ss shoot-ds run-MTN.M go

"(A hunter) saw (a tapir), (the hunter) shot (at the tapir), (the tapir) ran away."

literally: "(x) having seen, (x) having shot, (y) went running."

Clause-chaining constructions, such as the one seen above, are very prominent in A'ingae discourse; the same- and different-subject markers *-pa ss* and *-si ds* are extremely common. In addition to reference tracking, *-pa ss* and *-si ds* specify a temporal relation between two clauses: The event expressed in a *pa-* or *si-*marked clause must precede the event of the following clause. Inflectional categories, such as aspect and reality status, are most typically expressed on the verb of the last clause in a clause-chaining construction. Thus, I assume that the *pa-* and *si-*marked clauses are formally subordinate to the unmarked matrix clause. For a fuller discussion of the A'ingae switch-reference system, see AnderBois (2021).

The central takeaway is that reference tracking is an important category in the grammar of A'ingae. The language "cares" a lot about marking the (non)identity of subjects between a matrix clause and a subordinate clause, and uses various devices to achieve this goal. Even though *-pa ss* is formally unrelated to *-ta IF.SS* and *-si ds* is formally unrelated to *-ni IF.DS*, A'ingae maps the distinction between same- and different-subject marking found in clause-chaining onto the two complementizers found in conditional clauses.

3.2 Reality marking

In this section, I describe the reality-marking in A'ingae conditionals. In English neutral conditionals, the antecedent is required to be in the present tense. This is despite the fact that predictive conditionals typically pertain to future situations. In (9), for example, the situation of being late is a potential future situation, but this fact is not reflected in the tense of the antecedent; the tense of the antecedent is determined by the construction.

- (9) *If I am late for work, my boss will be mad.*

The tense of the consequent, on the other hand, is fully compositional. For example, a future tense is used in future predictive conditionals (10a) and the present simple is used to express universal truths (10b).

- (10) a. *If I am late for work, my boss will be mad.*
 b. *If you heat water up, it boils.*

A'ingae is a tenseless language. Information about the reference time is conveyed through a combination of rich aspectual morphology, reality marking, and temporal adverbs, such as *tayu* 'already,' *tuya* 'still,' *ja'nū* 'now,' *tayupi* 'long ago,' *kani* 'yesterday,' *tū'i* 'tomorrow,' etc.

In A'ingae simple non-conditional sentences, basic temporal/aspectual information can be conveyed by using plain verb forms, the imperfective *-je* IPFV, and the irrealis *-ya* IRR.³ In regular finite clauses, A'ingae need not bear any overt inflectional morphology. Plain uninflected verbs are most commonly interpreted as past/completive (11a). Verbs with the imperfective suffix *-je* IPFV are interpreted as ongoing present (11b). (For more on the A'ingae rich aspectual system, see Fischer and Hengeveld, *in press*.) Verbs with the irrealis suffix *-ya* IRR are commonly interpreted as future (11c).

- | | | | |
|------|-------------------------------------|---|---|
| (11) | a. <i>panza</i>
hunt
"hunted" | b. <i>panza -je</i>
hunt -IPFV
"is hunting" | c. <i>panza -ya</i>
hunt -IRR
"will hunt" |
|------|-------------------------------------|---|---|

Despite the fact that *-ya* IRR most commonly marks situations with future temporal reference, the morpheme is glossed as irrealis IRR, not future FUT. Irrealis is a very general grammatical mood category, which indicates that a given situation is not asserted at the moment of speaking. The morpheme *-ya* IRR is analyzed as irrealis because future reference is just one among many meanings that *-ya* IRR can express. For example, in combination with the nominalizing subordinator *-chu* SBRD, *-ya* IRR expresses obligation (12). Thus, the future use of *-ya* IRR is most adequately construed as one subfunction of a morpheme with more encompassing irrealis semantics.

- (12) *panza -ya -chu*
 hunt -IRR -SBRD
 "must hunt"

In A'ingae neutral conditionals, the antecedent is expressed with a verb form without *-ya* IRR (13). Thus, A'ingae resembles English in that the plainer verb forms are used in the antecedent. (Even though English uses the present tense, while A'ingae uses the bare form which is otherwise interpreted as completive.)

- (13) *Khuvima panza'tangi, avûjatshiya.*
khuvi=ma panza -ta =ngi avûjatshi-ya
 tapir=ACC hunt -IF.SS =1 happy-IRR
 "If I hunt a tapir, I will be happy."

³ After nasal vowels, the imperfective suffix is realized as *-jen* IPFV and the irrealis suffix—as *-ña* IRR.

Other than *-ya* IRR, the antecedent verb may bear other inflectional morphology, including the imperfective suffix *-'je* IPFV, the associated motion suffixes *-'ngi* VEN and *-'nga* AND (14a), or the negative suffix *-mbi* NEG (14b). The contributions made by these morphemes are compositional (not specific to the construction). In short, the antecedent can be regularly marked for any of the usual inflectional categories—with the exception of *-ya* IRR.

- (14) a. *Tise ja'ñu panza'jenga'tatsû, sûmbiya.*
tise ja'ñu panza -'je -nga -'ta =tsû sûmbi-ya
 3SG NOW hunt -IPFV -AND -IF.SS =3 stupid-IRR
 “If s/he went and is hunting now, s/he’s a moron.”
- b. *Khuvima panzambi'ta, ñukimbitshiya.*
khuvi=ma panza -mbi -'ta ñukimbitshi-ya
 tapir=ACC hunt -NEG -IF.SS sad-IRR
 “If (s/he) doesn’t hunt a tapir, (s/he) will be sad.”

The A’ingae consequents, on the other hand, are obligatorily marked with the irrealis *-ya* IRR. This is not obvious with consequents such as in (14b), which express a future situation, and so may be marked with *-ya* IRR for that reason. However, *-ya* IRR appears in non-future consequents as well. In (15a), the consequent expresses a present ongoing situation. In (15b), the consequent expresses a universal truth.

- (15) a. *Ña antian kufe'jembi'tatsû, ana'jeña.*
ña antian kufe-'je-mbi-'ta=tsû ana -'jen -ña
 1SG brother play-IPFV-NEG-IF.SS=3 sleep -IPFV -IRR
 “If my brother is not playing, he is sleeping.”
- b. *Tsa'khû kû'ta, gua'thiya.*
tsa'khû kû-'ta gua'thi -ya
 water warm up-IF.SS boil -IRR
 “If the water warms up, it boils.”

These examples show that the use of the irrealis *-ya* IRR in conditional consequents is required by the construction, and not dependent on the tense of the consequent. The morpheme *-ya* IRR has a very non-specific irrealis meaning, which is compatible with a variety of functions, including future temporal reference (11c) and necessity (12). In conditional constructions, it is specifically recruited to mark the consequent, and therefore the irrealis of the conditional sentence.

In summary, A’ingae neutral conditionals have the following properties: First, the antecedents are headed by *-'ta* IF.SS or *-'ni* IF.DS, depending on whether the subject of the antecedent is the same as or different from the subject of the consequent. Second, the antecedents require verb forms not marked with the irrealis suffix *-ya* IRR. The consequents require verb forms marked with *-ya* IRR. The contributions of other inflectional morphemes are compositional.

3.3 CxG formalization

In this section, I present a constructional analysis of A’ingae neutral conditionals. In English, the antecedent (the *if*-clause) is an adjunct to the consequent (the matrix clause). The antecedent is

headed by *if* and the rest of the clause is its complement (16a). I propose that the basic syntactic structure of the A'ingae neutral conditionals is essentially the same: the antecedent is headed by *-ta* IF.SS or *-ni* IF.DS and adjoined to the matrix-clausal consequent (16b).

- (16) a. [*If*_{head} [*I hunt a tapir*]_{complement}]_{adjunct} *I will be happy.* English
 b. *Khkvoima panza'tangi avûjatshiya.* A'ingae
 [[*khuvi=ma panza*]_{complement} *-ta*_{head}]_{adjunct} *=ngi avûjatshi-ya*
 tapir=ACC hunt -IF.SS =1 happy-IRR
 "If I hunt a tapir, I will be happy."

Thus, the *if*-clause instantiates the *head-complement* construction. I assume that the basic properties of the *head-complement* construction are as in (17). The *head-complement* construction specifies that the *head* combines with its *arguments* (the value of its VALENCE attribute). Since A'ingae is generally right-headed, the *arguments* come before the *head*. The syntactic category of the whole construction is that of the head (i. e. the value of the HEAD attribute is passed up from the *head* to the entire construction). As the *head* combines with its *arguments*, a maximal phrase is created. Thus, the value of MAX changes form – at the level of the head to + at the level of the whole construction. The SEMANTICS of the whole construction unifies the individual FRAMES of the *head* and its *arguments*.

(17) *head-complement*

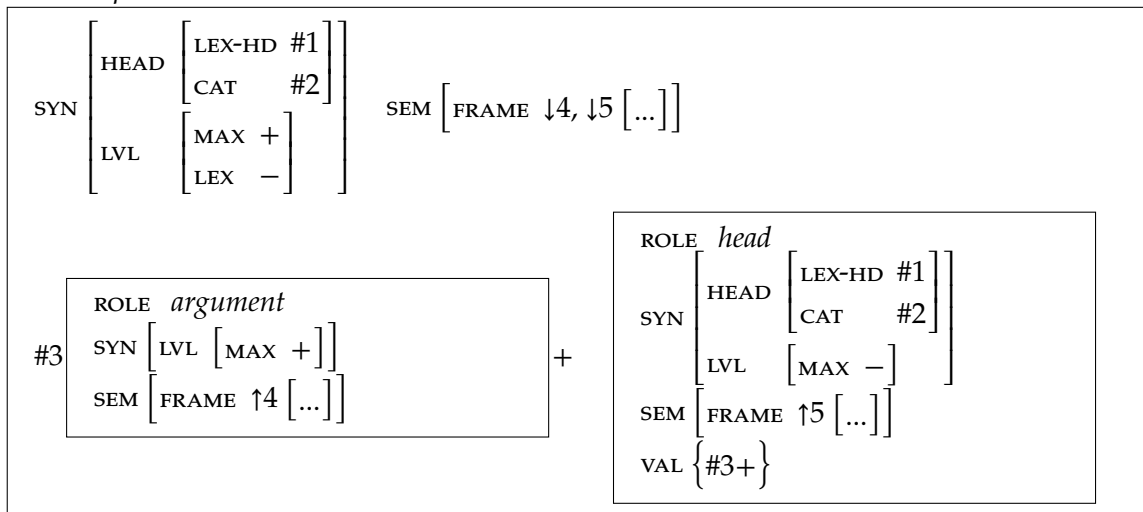

The conditional antecedents are headed by *-ta* IF.SS or *-ni* IF.DS. I propose that both suffixes inherit from the *complementizer lexeme* construction (18). The *complementizer lexeme* construction specifies that complementizers are of CATEGORY *comp*. They are words (LEX +) and they are nonmaximal (MAX –), which means that they need to combine with their argument. Specifically, they need to combine with a full clause (CAT *v*, MAX +, SUBJ +), which is the only entry on their VALENCE list.

(18) *complementizer lexeme*

SYN	HEAD	[CAT <i>comp</i>]
	LVL	[MAX -] [LEX +]
VAL	SYN	HEAD [CAT <i>v</i>]
		LVL [MAX +] [SUBJ +]

The conditional consequents are marked with the irrealis suffix *-ya* IRR. This is modeled with the *irrealis* construction (19). The *irrealis* construction combines a verb unspecified for the value of IRR and the irrealis suffix *-ya* IRR (IRR +). At the level of the whole construction, the value of IRR is +. The SEMANTICS contributed by this construction is the IRREALITY FRAME.

(19) *irrealis*

SYN	HEAD	[CAT #1 <i>v</i>] [IRR +]	SEM	FRAME	[IRREALITY] [SITUATION ↓1]												
<table border="1"> <tr> <td>SYN</td> <td>HEAD</td> <td>[CAT #1<i>v</i>]</td> </tr> <tr> <td>SEM</td> <td>FRAME</td> <td>↑1 [...]</td> </tr> </table>			SYN	HEAD	[CAT #1 <i>v</i>]	SEM	FRAME	↑1 [...]	<table border="1"> <tr> <td>ROLE</td> <td><i>affix</i></td> </tr> <tr> <td>SYN</td> <td>HEAD [IRR +]</td> </tr> <tr> <td>LXM</td> <td><i>-ya</i></td> </tr> </table>			ROLE	<i>affix</i>	SYN	HEAD [IRR +]	LXM	<i>-ya</i>
SYN	HEAD	[CAT #1 <i>v</i>]															
SEM	FRAME	↑1 [...]															
ROLE	<i>affix</i>																
SYN	HEAD [IRR +]																
LXM	<i>-ya</i>																

The conditional antecedents may not be marked with the irrealis suffix *-ya* IRR. This is modeled by the *realis* construction (20). Since A'ingae lacks an overt realis suffix, the *realis* construction simply marks a verb as IRR – without adding any morphology. I assume that the *realis* construction does not contribute any semantics of its own. Rather, the reality status of an unmarked clause is determined by its context and larger constructions it is part of.

(20) *realis*

SYN	HEAD	[CAT #1 <i>v</i>] [IRR -]	SEM	FRAME	↓1						
<table border="1"> <tr> <td>SYN</td> <td>HEAD</td> <td>[CAT #1<i>v</i>]</td> </tr> <tr> <td>SEM</td> <td>FRAME</td> <td>↑1 [...]</td> </tr> </table>						SYN	HEAD	[CAT #1 <i>v</i>]	SEM	FRAME	↑1 [...]
SYN	HEAD	[CAT #1 <i>v</i>]									
SEM	FRAME	↑1 [...]									

A'ingae distinguishes same-subject adjuncts from different-subject adjuncts. Clause-chaining constructions and conditional constructions use different morphemes for reference tracking (*-pa* SS and *-si* DS in clause chaining vs. *-ta* IF.SS and *-ni* IF.DS in conditionals). However, the same distinction between same-subject and different-subject clauses is retained.

I propose that A'ingae has two high-level constructions from which various adjunct clauses inherit: *same-subject adjunct* and *different-subject adjunct*. The *same-subject adjunct* construction specifies that the INDEX of the *subject* of the *adjunct* clause is the same as the INDEX of the *subject* of the matrix *head* clause (21).

(21) *same-subject adjunct*

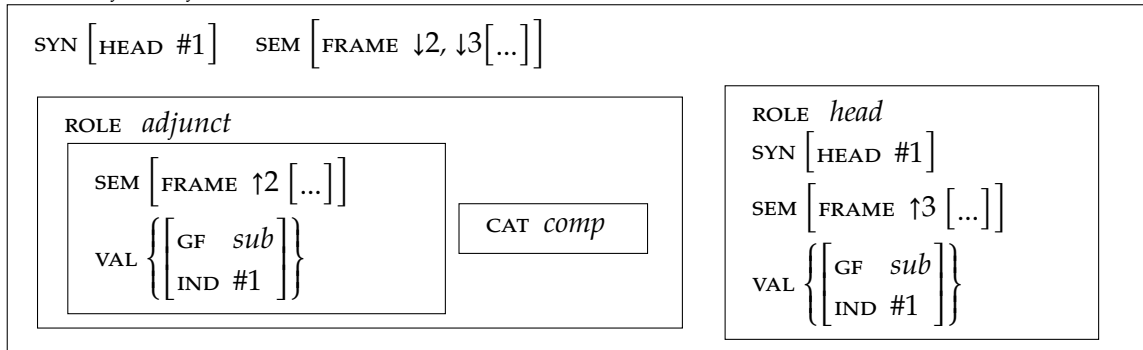

The *different-subject adjunct* construction specifies that the INDEX of the *subject* of the *adjunct* clause is different from the INDEX of the *subject* of the matrix *head* clause (22). Observe that the *same-subject adjunct* construction and the *different-subject adjunct* construction do not specify the phonological form of the *complementizer*. The phonological form of the complementizer is dependent on the constructions which further inherit from *same-subject adjunct* and *different-subject adjunct*.

(22) *different-subject adjunct*

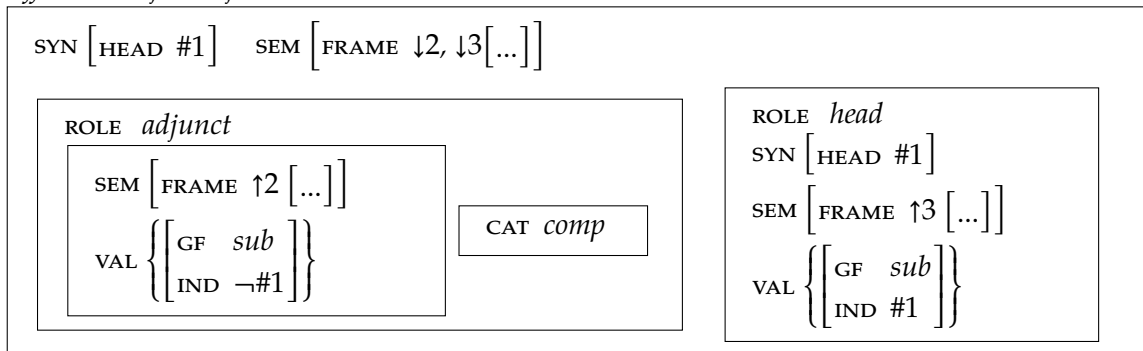

I propose that all clause-chaining sentences inherit from the *clause-chaining* construction (23). This construction is not the final construction for clause-chaining. Rather, it is a higher-level construction from which other more fully fleshed-out clause-chaining constructions inherit.

The *clause-chaining* construction combines two clauses: the antecedent, which is a clausal *adjunct*, and the consequent, which is the matrix clausal *head*. The *adjunct* clause is headed by a *complementizer*.⁴ The SEMANTICS contributed by the *conditional* construction is the EVENT-SEQUENCE FRAME. The EVENT-SEQUENCE FRAME relates a PRIOR event and a POSTERIOR event. The *adjunct* clause contributes the PRIOR event. The *head* clause contributes the POSTERIOR event.

⁴ Observe that many attributes of the clause headed by the *complementizer*, such as CAT *v* and SUBJ +, are not explicitly shown here; they follow from the specification of the *complementizer lexeme* construction in (18).

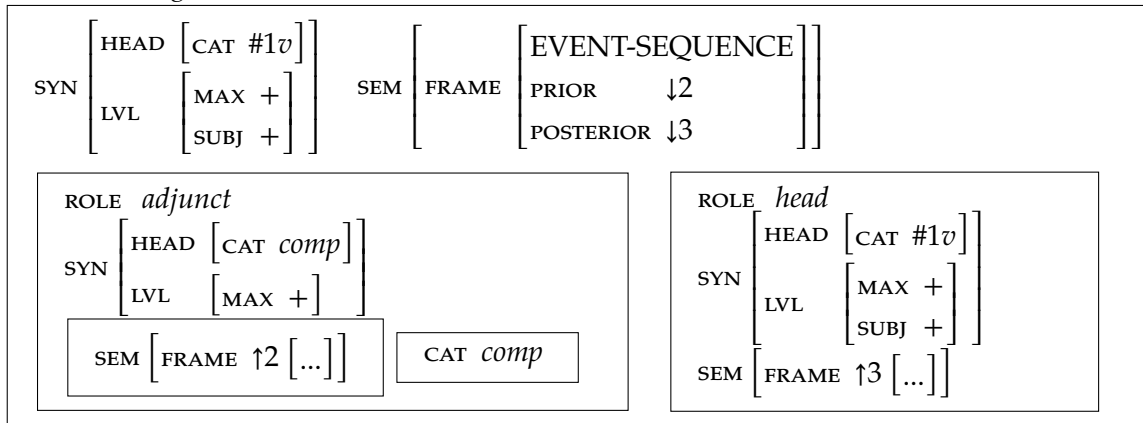
(23) *clause-chaining*

All actual clause-chaining constructs inherit from the *clause-chaining* construction and the *same-subject adjunct* construction (24a) or the *different-subject adjunct* construction (24b). The tree branches represent inheritance relations.

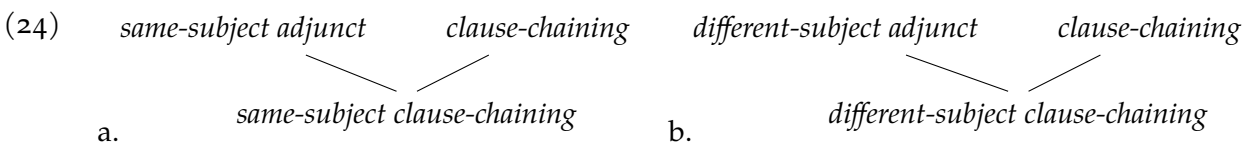

The *same-subject clause-chaining* construction has no semantic or syntactic properties beyond those already specified for the *clause-chaining* and *same-subject adjunct* constructions. Thus, the only new thing that needs to be said about the *same-subject clause-chaining* construction is that the complementizer LEXEME it requires is the same subject marker *-pa* (25).

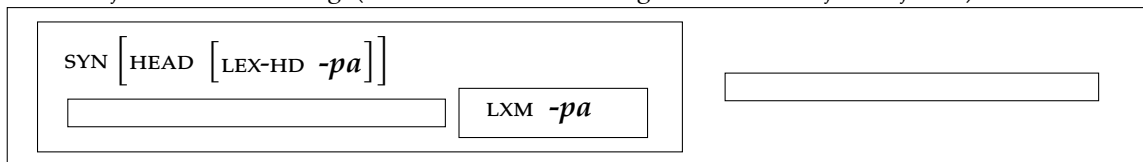
(25) *same-subject clause-chaining* (inherits *clause-chaining* and *same-subject adjunct*)

Similarly, the only new thing that needs to be said about the *different-subject clause-chaining* construction is that the complementizer LEXEME it requires is the different subject marker *-si* (26).

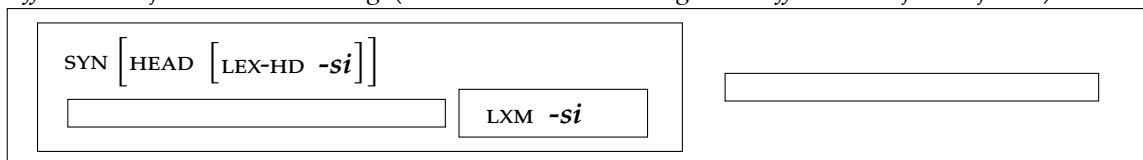
(26) *different-subject clause-chaining* (inherits *clause-chaining* and *different-subject adjunct*)

Finally, I formalize the analysis of conditional sentences. I propose that all conditional sentences inherit from the *conditional* construction (27). Again, the *conditional* construction is not the final

construction for conditional sentences, but rather a higher-level construction from which other more fully fleshed-out conditional constructions inherit.

(27) *conditional*

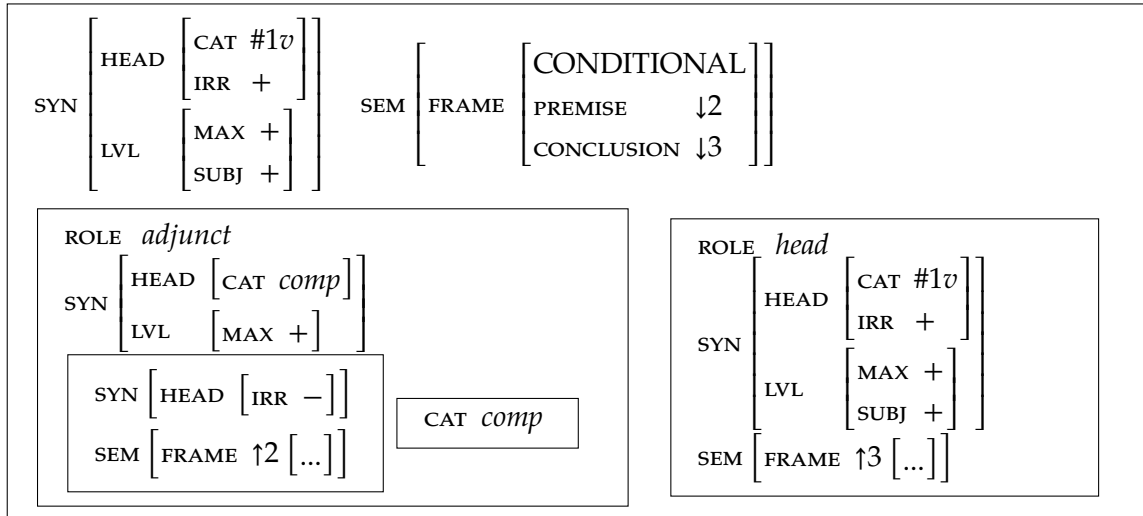

The *conditional* construction combines two clauses: the antecedent, which is a clausal *adjunct*, and the consequent, which is the matrix clausal *head*. The *adjunct* clause is headed by a *complementizer* whose argument is a realis (IRR –) clause. The *head* clause is marked with the irrealis suffix *-ya* IRR (IRR +). The whole conditional sentence inherits the HEAD attributes of the matrix clause; thus, it is irrealis (IRR +). The SEMANTICS of the *conditional* construction is the CONDITIONAL FRAME. The CONDITIONAL FRAME relates a PREMISE and a CONCLUSION. The *adjunct* clause contributes the PREMISE. The *head* clause contributes the CONCLUSION.

All actual conditional constructs inherit from the *conditional* construction and the *same-subject adjunct* construction (28a) or the *different-subject adjunct* construction (28b).

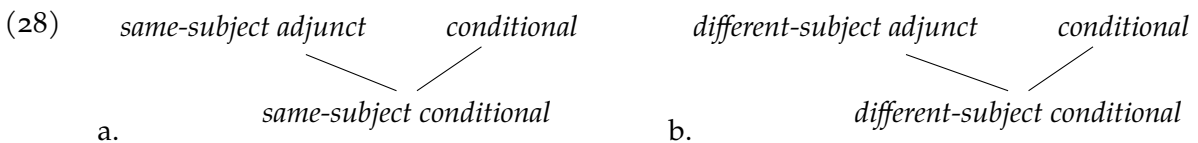

The *same-subject conditional* construction has no semantic or syntactic properties beyond those already specified for the *conditional* and *same-subject adjunct* constructions. Thus, the only new thing that needs to be said about the *same-subject conditional* construction is that the complementizer LEXEME it requires is the same subject antecedent marker *-’ta* (29).

(29) *same-subject conditional* (inherits *conditional* and *same-subject adjunct*)

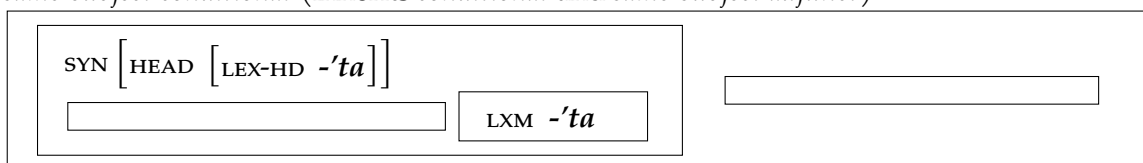

Similarly, the only new thing that needs to be said about the *different-subject conditional* construction is that the complementizer LEXEME it requires is the different subject antecedent marker *-ni* (30).

- (30) *different-subject conditional (inherits conditional and different-subject adjunct)*

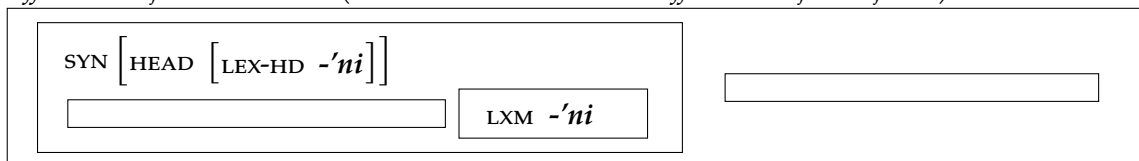

4 DISTANCED CONDITIONALS

In this section, I describe and analyze the distanced conditional construction. The distanced conditionals indicate that the speaker considers the described eventuality as unlikely or dispreferred (Dancygier and Sweetser, 2005). In English, distanced conditionals are formed with past-tense verb forms in the antecedent as well as the consequent. Compare the neutral condition in (31a) with the distanced conditional in (31b). The latter, but not the former, presents the situation of opening the window as unlikely.

- (31) a. *If he opens the window, it will get cold.*
 b. *If he opened the window, it would get cold.*

The rest of this section is organized as follows. Section 4.1 describes distanced conditionals in A'ingae. Section 4.2 proposes that A'ingae recruits similative morphology to convey mental space distance. Section 4.3 presents a constructional formalization of the data.

4.1 Description

In this section, I describe the basic form of A'ingae distanced conditionals. The A'ingae distanced conditionals use the same grammatical resources as the neutral conditional to encode the core conditional meaning. In addition, they draw on the similative domain to encode distanced epistemic stance. Finally, they have non-compositional and unpredictable aspects, which I analyze as construction-specific solutions to the selectional requirements of particular morphemes.

The A'ingae construction used to express distanced conditionals is given in (32). The antecedent is formed by suffixing the verb with *-chue'kan'nda* (or *-chue'kan'ni*, depending on subject non/identity between the two clauses). The consequent is formed by suffixing the verb with *-ya'kaen*.

- (32) *Khuvoima panza'chue'kan'dangi, avûjatshiya'kaen.*
khuvi=ma panza -'chu -e -'kan -'nda =ngi avûjatshi -ya -'kan -en
 tapir=ACC hunt -SBRD -ADV -SML -IF.SS =1 happy -IRR -SML -ADV
 "If I had hunted a tapir, I would have been happy."

The translation given for example above is in the past. However, unlike the English translation, the A'ingae construction does not encode temporal reference. This is to say, the same construction can be used to express a distanced present conditional (33).

- (33) *Ña antian vueyi panza'je'chue'ka'ndatsû, fithi'jeya'kaen injan'tshia aña'chuma.*
ña antian vueyi panza -'je -'chu -e -'kan -'nda -tsû
 1SG brother right now hunt -IPFV -SBRD -ADV -SML -IF.SS =3
fithi -'je -ya -'kan -en injan'tshia aña'chu=ma
 kill -IPFV -IRR -SML -ADV many animal-ACC
 “If my brother were hunting right now, he would be killing many animals.”

In the examples above, we see that distanced conditionals share some properties with neutral conditionals. Specifically, the antecedent is headed by *-ta* IF.SS or *-ni* IF.DS and the consequent is marked for irrealty with *-ya* IRR. Thus, distanced conditionals are at least partly compositional in that the core conditional meaning is encoded in the same way as in the neutral conditionals.

Finally, both the *chue'kan*-clause contained in the antecedent (34a) and the consequent *ya'kaen*-clause (34b) can stand on their own. When they do, their semantics is similar: they both express a negative epistemic stance.

- (34) CONTEXT: A person goes hunting. They are about to shoot a tapir, but a dog comes running and barks, making the tapir flee.
- a. *Tise tsû khûvima panza'chue'kan*
tise tsû khûvi=ma panza -'chu -e -'kan
 3SG 3 tapir=ACC hunt -SBRD -ADV -SML
 “S/he would have hunted the tapir (if the dog hadn’t scared it away).”
- b. *Tise tsû khûvima panzaya'kaen.*
tise tsû khûvi=ma panza -ya -'kan -en
 3SG 3 tapir=ACC hunt -IRR -SML -ADV
 “S/he would have hunted the tapir (if the dog hadn’t scared it away).”

4.2 Similitive marking

The distanced conditional construction inherits the properties of the neutral conditional construction: the antecedent is headed by *-ta* IF.SS or *-ni* IF.DS and the consequent is marked for irrealty with *-ya* IRR. However, there are also other elements which are absent from neutral conditionals. These elements are *-'chue'kan* in the antecedent and *-'kaen* in the consequent. The question addressed in this section is: How much can the contribution of these particular morphemes be broken down and to what extent is the distanced conditional construction non-compositional?

First, observe that the morphology seen in the *chue'kan*-antecedents and *ya'kaen*-consequents of distanced conditionals shares one commonality: both clauses contain the similitive suffix *-'kan* SML. In its basic usage, the similitive suffix *-'kan* SML can serve as a comparative predicate (35a). When followed by the adverbial *-e* ADV,⁵ it functions as a comparative verbal modifier (35b).

⁵ After nasal vowels, the adverbial *-e* ADV is realized as *-en* ADV.

- (35) a. *Va ain tsû khuvi'kan.*
va ain tsû khuvi -'kan
 this dog 3 tapir -SML
 “This dog looks like a tapir.”
- b. *Va ain tsû bûtho'je khuvi'kaen.*
va ain tsû bûtho-'je khuvi -'kan -en
 this dog 3 run-IPFV tapir -SML -ADV
 “This dog is running like a tapir.”

I propose that the similative *-'kan* SML is the primary contributor of the meaning which characterizes negative epistemic stance conditionals. Specifically, the similative *-'kan* SML has been recruited to express mental space distance. In English, distanced conditionals use past tense (31b). Past tense is a cross-linguistically robust way of marking the relationship between mental spaces (Cutrer, 1994; Dancygier and Sweetser, 2005; Fauconnier, 1994). Most commonly, past tense expresses temporal distance. In distanced conditionals, however, the same grammatical form is recruited to express mental distance. A distanced mental space is construed as dispreferred or less likely.

Yet, A'ingae does not have tense. Therefore, other means must be recruited to convey mental space distancing. I propose that in A'ingae, the similative *-'kan* SML serves this purpose. The basic function of the similative *-'kan* is to express comparison. Comparison involves the construction of a mental space that is distanced from the immediate here and now of the ground. (For more on the notion of the ground, see Langacker, 1991). For example, the dog which looks like a tapir is not a tapir (35a). Similarly, running like a tapir typically implies that the running entity is not a tapir (35b). The use of the similative can therefore be understood as an instruction to “simulate” a situation which does not currently obtain, and may never do so.

Therefore, the use of *-'kan* SML in distanced conditionals can be seen as a kind of semantic bleaching: The conditional uses of *-'kan* SML retain the distanced mental space aspect of its comparative uses. However, no actual comparison is involved. This is similar to the English use of past tense in distanced conditionals: The use of the past forms indicates a distanced mental space without actually having a past reference. For both the English use of past forms and the A'ingae use of similative forms, we

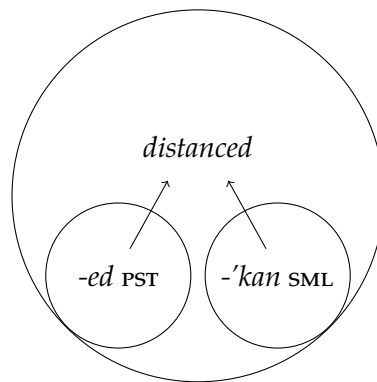

Figure 1: The English recruitment of the past *-ed* PST and the A'ingae recruitment of the similative *-'kan* SML to express mental space distancing in conditional constructions.

see a diachronic pathway from a more restricted meaning to a broader meaning, in line with the findings of Deo (2015). These pathways are schematized in Figure 1.

I suggest that the other morphemes which are part of the distanced conditional construction—the nominalizing subordinator *-’chu* SBRD and the adverbial *-e* ADV—do not make significant semantic contributions. Rather, they are used to primarily fulfill certain selection restrictions of the similative *-’kan* SML. Specifically, the similative *-’kan* SML cannot directly combine with a bare verb (36a). However, it can combine with the adverbial *-e* ADV (36b).

- (36) a. **panza -’kan* b. *-e -’kan*
 hunt -SML ADV -SML

There is independent evidence which corroborates this selectional restriction. The similative morpheme is polysemous with (or has another historically related use as) a dummy auxiliary verb *kan* AUX. The dummy auxiliary *kan* AUX is used to bypass morphological restrictions on morpheme co-occurrence. For example, the negative *-mbi* NEG (37a) the infinitive *-ye* INF (37b) cannot cooccur on one verb (37c). In order to express a negated infinitive, one must negate the main verb and infinitivize the dummy auxiliary *kan* AUX. Importantly, the dummy auxiliary *kan* AUX combines with an adverbialized form of the negated verb (37d). Thus, we see that the related *kan* AUX selects for adverbialized complements.

- (37) a. *panza -mbi* b. *panza -ye* c.*?*panza -mbi -ye* d. *panza -mb -e kan -ñe*
 hunt -NEG hunt -INF hunt -NEG -INF hunt -NEG -ADV AUX -INF
 “did not hunt” “to hunt” int.: “not to hunt” “not to hunt”

Furthermore, I suggest that the presence of the nominalizing subordinator *-’chu* SBRD is due to the selectional requirements of the adverbial *-e* ADV. The adverbial *-e* ADV cannot combine directly with a bare verb (38a). However, it can combine with a *’chu*-nominalization (38b).

- (38) a. **panza -e* b. *panza -’chu -e*
 hunt -ADV hunt -SBRD -ADV

There is independent evidence which corroborates this selectional restriction. In combination with the irrealis *-ya* IRR, the nominalizing subordinator *-’chu* and the adverbial *-e* ADV form one strategy for expressing rationale clauses (39). (For an extensive discussion of another strategy for expressing rationale clauses in A’ingae, see Dąbkowski and AnderBois, 2021). Thus, we see that the adverbial *-e* ADV selects for *’chu*-nominalizations.

- (39) a. *Tsumba tise’pa afepuen’chuma’khe afepueña’chu kûintsû tise’pa tusema chathûya’chue.*
tsun-mba tise’pa afepuen’chu=ma-’khe afepuen-ña’-chu kûintsû tise’pa tuse=ma
 do-SS 3PL expenses=ACC=ADD pay-IRR-SBRD so that 3SG hair=ACC
chathû-ya -’chu -e
 cut-IRR -SBRD -ADV
 “[A]nd pay their expenses, so that they can have their heads shaved.” (Acts 21:24)

- b. *Nane kha'i'sû Chigave in'jamba bu'fa'chundekhû afe'chu kurifin'dima gi isû tisû khe'i'khû kan'jemba chavapa añ'a'chue.*

nane kha'i-sû Chiga=ve in'jan-mba bu-'fa-'chu-ndekhû afe-'chu kurifin'di=ma gi isû
truly other-ATTR God=ACC2 think-SS gather-PLS-SBRD-PL give-SBRD money=ACC 1 take
tisû khe'i-'khû kan'jen-mba chava-pa an-ña -'chu -e
self 2PL-COM be.ANM-SS buy-SS eat-IRR -SBRD -ADV

“I (robbed) other churches by receiving support from them so as to serve you.”

(2 Corinthians 11:8)

In interim summary, I propose that the negative epistemic stance characteristic of distanced conditionals is conveyed primarily by the simulative *-'kan* SML, as the morpheme had undergone semantic bleaching to encode a distanced mental space. The adverbial *-e* ADV and the nominalizing subordinator *-'chu* SBRD are introduced to satisfy the selectional requirements of, respectively, *-'kan* SML and *-e* ADV.

Finally, the consequents of distanced conditionals are marked with the irrealis *-ya* IRR, the simulative *-'kan* SML, and, optionally, the adverbial *-e* ADV. The presence of absence of the adverbial *-e* ADV does not affect the grammaticality of (40).

- (40) *Tise kan'jen'chuekan'da tsû ku'feya'ka(e)n.*
tise kan'jen-'chu-e-kan-'nda tsû ku'fe -ya -'kan (-en).
3SG be.ANM-SBRD-ADV-SML-IF.SS 3 play -IRR -SML -ADV
“If s/he had been, s/he would have played.”

The contribution of the irrealis *-ya* IRR is compositional in that A'ingae consequents are regularly marked with *-ya* IRR, as was shown in Section 3.2. The contribution of the simulative *-'kan* SML is the same as in conditional antecedents—it expresses mental space distance. No functional morphemes are present between the simulative *-'kan* SML and the irrealis *-ya* IRR, which means that the simulative *-'kan* SML can combine with an irrealis verb directly. Finally, the presence of the adverbial *-e* ADV is optional. I take it to mean that there were two grammaticalization pathways for the distanced conditional consequents: one from (35a) and another from (35b).

4.3 GxC formalization

In this section, I extend the GxC formalization to A'ingae distanced conditionals. In a distanced conditional construction, the antecedent contains a *chue'kan*-clause. The *chue'kan*-clause construction is headed by the simulative suffix *-'kan*. The simulative *-'kan* functions as a *verbal head* which selects for an *argument* HEADED by an *adverb*. The *argument* of *-'kan* is headed by the adverbial *-e*. The adverbial *-e* functions as an *adverbial head* which selects for an *argument* HEADED by a *noun*. The *argument* of *-e* is headed by the nominalizing subordinator *-'chu*. The nominalizing subordinator *-'chu* functions as a *nominal head* which selects for an *argument* headed by a *verb*. The *argument* of *-'chu* is headed by the main verb of the antecedent. Conditional antecedents are not marked as irrealis. Thus, the value of IRR on the innermost *verb* is $-$. This value is passed up to the HEAD attribute of the entire *chue'kan*-clause. The SEMANTICS contributed by the *chue'kan*-clause construction is the DISTANCED FRAME. The DISTANCED FRAME unifies with the SITUATION expressed by the main verb of the antecedent (41).

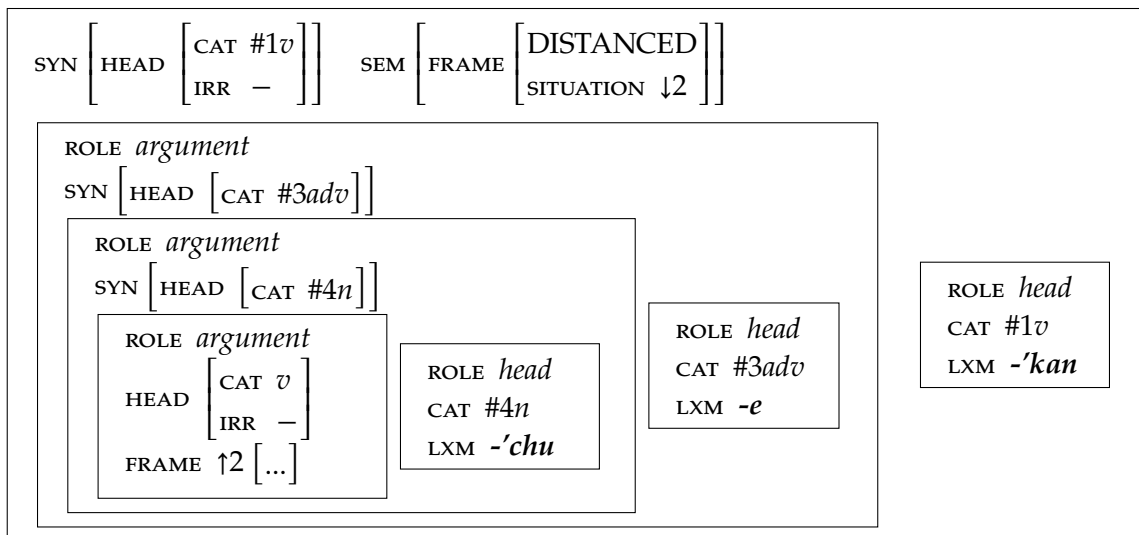
(41) *chue'kan-clause*

The consequent of a distanced conditional construction is a *ya'kaen-clause*. The *ya'kaen-clause* construction is headed by the similative suffix -'ka(e)n. The similative -'ka(e)n functions as a *verbal head* which selects for an *argument* HEADED by a *verb*. The *argument* of -'ka(e)n is headed by the main verb of the consequent. Conditional consequent are marked as realis. Thus, the value of IRR on the innermost *verb* is +. This value is passed up to the HEAD attribute of the entire *ya'kaen-clause*. The SEMANTICS contributed by the *ya'kaen-clause* construction is also the DISTANCED FRAME. The DISTANCED FRAME unifies with the SITUATION expressed by the main verb of the antecedent (42).

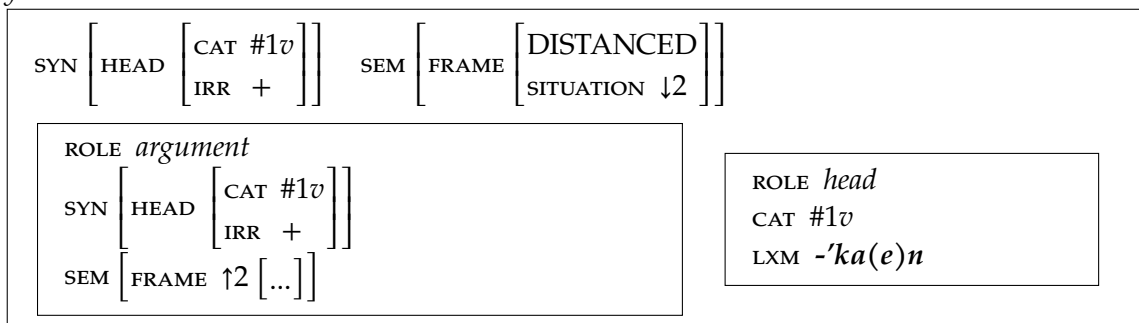
(42) *ya'kaen-clause*

The *distanced conditional* construction inherits from the *conditional* construction and combines a *chue'kan-clause*, a complementizer, and a *ya'kaen-clause*. The semantics of the *distanced conditional* is thus entirely predictable: The *conditional* construction contributes the CONDITIONAL FRAME and the *chue'kan-* and *ya'kaen-clauses* contribute the DISTANCED FRAME. The complementizer depends on whether the subject of the conditional is the same as or different from the subject of the consequent. Thus, nothing else needs to be said about the *distanced conditional* construction (43).

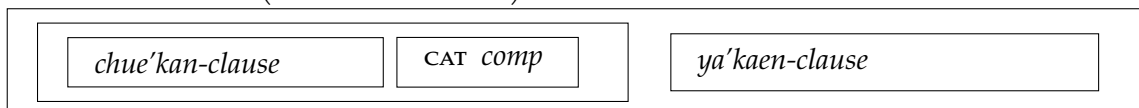
(43) *distanced conditional (inherits conditional)*

Finally, all distanced conditional constructs inherit from the *distanced conditional* construction as well as the *same-subject conditional* construction (44a) or the *different-subject conditional* construction (44b). The *distanced conditional* construction contributes the distanced conditional semantics. The *same-* and *different-subject conditional* constructions determine the choice of the complementizer (the same subject antecedent marker *-’ta* or the different subject antecedent marker *-’ni*). Thus, nothing else needs to be specified about the *same-* and *different-subject distanced conditional* constructions beyond their inheritance relations.

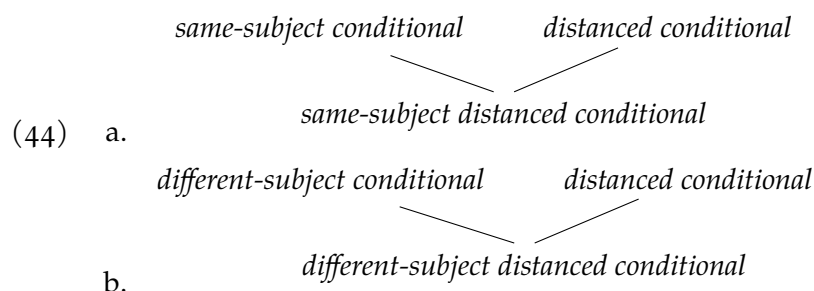

5 CONCLUSIONS

The A’ingae conditional constructions have a number of properties which range from fully compositional to fully-construction specific. On one end of the spectrum, the lexical content of the conditional antecedents and consequents is fully compositional. On the other end, the complementizers which introduce conditional antecedents (*-’ta* IF.SS and *-’ni* IF.DS) are entirely unpredictable, i. e. construction-specific.

Other aspects of A’ingae conditionals show partial compositionality. For example, the irrealis suffix *-ya* IRR contributes to a wide range of meanings, including future temporal reference and deontic modality. In conditional clauses, the irrealis *-ya* IRR is used to mark the consequent. Since conditional consequents are unasserted at the time of the utterance, this use of *-ya* IRR is consistent with, but more specific than, its broad irrealis semantics.

A’ingae conditionals also implement a semantic distinction attested elsewhere in the grammar, but with formally unrelated devices. The distinction between same- and different-subject adjuncts is very prominent in A’ingae. In clause-chaining constructions, it is encoded with *-pa* SS and *-si* DS. In conditional constructions, the same distinction is encoded with the formally unrelated *-’ta* IF.SS and *-’ni* IF.DS. This shows the functional importance of the same/different-subject distinction in the grammar of A’ingae. In Construction Grammar, this generalization can be captured by positing a superordinate construction from which clause-chaining constructions and conditional constructions both inherit.

Finally, A’ingae distanced conditionals are expressed using the simulative suffix *-’kan* SML. The prototypical function of the simulative *-’kan* SML is to express qualitative comparison. Comparison requires reference to a mental space which is distanced from the ground. I propose that the use of the simulative *-’kan* SML in distanced conditionals is a form of semantic bleaching: It invokes mental space distancing without the component of comparison.

BIBLIOGRAPHY

- AnderBois, Scott (2021). "Switch reference in A'ingae." Manuscript. Providence, RI: Brown University.
- AnderBois, Scott, Nicholas Emlen, Hugo Lucitante, Chelsea Sanker, and Wilson Silva (2019). "Investigating linguistic links between the Amazon and the Andes: The case of A'ingae." Paper presented at the 9th Conference on Indigenous Languages of Latin America. University of Texas at Austin.
- Borman, Roberta "Bobbie" (1980). "A'ingae III. Texto de lectura III: Cofán–castellano." Quito, Ecuador: Republica del Ecuador Ministerio de Educación y Cultura (Republic of Ecuador Department of Education and Culture) and Instituto Lingüístico de Verano (Summer Institute of Linguistics).
- Cutrer, L. Michelle (1994). "Time and tense in narrative and in everyday language." PhD thesis. University of California, San Diego.
- Dąbkowski, Maksymilian (2021). "A'ingae (Ecuador and Colombia) – Language snapshot." In: *Language Documentation and Description* 20, pp. 1–12. URL: <http://www.elpublishing.org/itempage/223>.
- Dąbkowski, Maksymilian and Scott AnderBois (2021). "Rationale and precautioning clauses: Insights from A'ingae." Manuscript. University of California, Berkeley and Brown University.
- Dancygier, Barbara and Eve Sweetser (2005). *Mental Spaces in Grammar: Conditional constructions*. Cambridge Studies in Linguistics 108. Cambridge University Press.
- Deo, Ashwini (2015). "Diachronic semantics." In: *Annual Review of Linguistics* 1.1, pp. 179–197.
- Fauconnier, Gilles (1994). *Mental Spaces: Aspects of meaning construction in natural language*. Cambridge University Press.
- Fillmore, Charles J. and Paul Kay (1996). *Construction Grammar*. Manuscript.
- Fillmore, Charles J., Paul Kay, and Mary Catherine O'Connor (1988). "Regularity and idiomaticity in grammatical constructions: The case of *let alone*." In: *Language* 64.3, pp. 501–538.
- Fischer, Rafael and Kees Hengeveld (in press). "A'ingae (Cofán/Kofán)." In: *Amazonian Languages. An International Handbook*. Vol. 1: *Smaller Language Families and Isolates*. Ed. by Patience Epps and Lev Michael. Handbooks of Linguistics and Communication Science (HSK) 44. Berlin: De Gruyter Mouton.
- Goldberg, Adele E. (2006). *Constructions at Work: The Nature of Generalization in Language*. Oxford University Press.
- Langacker, Ronald W. (1991). *Concept, Image, and Symbol: The Cognitive Basis of Grammar*. Ed. by René Dirven and Ronald W. Langacker. Cognitive Linguistics Research (CLR) 1. Berlin/New York: Mouton de Gruyter.
- The Bible* (1980). Chiga Tevaen'jen. Las Sagradas Escrituras en el idioma Cofán del Ecuador. Wycliffe Inc.