

**Principles of Argument Structure:  
A Merge-Based Approach**

Chris Collins, New York University

## Contents

### Acknowledgments

- 1 Introduction
- 2 The Phi-Features of the Implicit Argument
- 3 Secondary Predicates and the Implicit Argument
- 4 A Theory of Implicit Arguments
- 5 *by*-Phrases
- 6 Some Sample Derivations
- 7 Two Conceptions of VoiceP
- 8 The Dative Alternation
- 9 On the Tension with Formal Semantics
- 10 Conclusion

### References

## Acknowledgments

I thank Nikos Angelopoulos, Adriana Belletti, Erich Groat, Richard Kayne, Hilda Koopman, Richard Larson, Paul Postal, Andrew Radford, Tom Roeper, Thomas Stroik and Arhonto Terzi for discussing the issues in this book with me. My collaboration with Nikos Angelopoulos and Arhonto Terzi on the comparison of Greek and English (Angelopoulos, Collins and Terzi 2020) was especially valuable in helping me to understand the cross-linguistic scope of the principles involved. My collaboration with Adriana Belletti on the OUP smuggling volume (Belletti and Collins 2020) was useful to me in sharpening up my ideas on the dative alternation, and smuggling more generally.

Special thanks go to Nikos Angelopoulos, Selikem Gotah and Gary Thoms for reading the complete draft of the manuscript and giving me detailed feedback.

Thanks also to the participants of my NYU seminars (Fall 2018 and Fall 2021) on argument structure for useful feedback on the data and on the developing ideas. The Fall 2018 participants were: Omar Agha, Gurprit Bains, Karoliina Lohiniva, Kate Mooney, Yining Nie, Dan Simon and Hongchen Wu. The Fall 2021 participants were: Rachel Christensen, Mica Clausen, Selikem Gotah, Stephanie Harves, Soo-Hwan Lee, John David Storment and Gary Thoms. I also presented various sections in other syntax courses (including Grammatical Analysis II, Spring 2018 and Syntax I, Fall 2020). Thanks to the students of those courses for their feedback.

I benefited from the feedback of members of the audience at the UCONN Department of Linguistics (February 7, 2020), where I presented the talk “The Implicit Argument in the Passive: Rethinking Collins (2005)”.

The material in chapters 5 and 8 incorporates material from the following two papers respectively.

Angelopoulos, Nikos, Chris Collins and Arhonto Terzi. 2020. Greek and English Passives and the Role of *by*-Phrases. *Glossa* 5(1): 90, 1-29.

Collins, Chris. 2020. A Smuggling Approach to the Dative Alternation. In Adriana Belletti and Chris Collins (eds), *Smuggling in Syntax*, 96-107. Oxford University Press.

# 1 Introduction

## 1.1 Leading Ideas

This book investigates principles of argument structure in minimalist syntax through an in-depth analysis of certain properties of the English passive construction, illustrated in (1):

- (1) a. John wrote the book. (active)  
b. The book was written by John. (passive)  
c. The book was written. (short passive)

The paradigm in (1) raises questions about argument structure. First, is the underlying syntactic position of the DP *John* in (1a) the same or different from the underlying syntactic position of the *by*-phrase in (1b)? Another way to put the question is this: is the external argument projected in the same way in the active and the passive? Furthermore, what principles of UG determine these positions?

The relation between the passive and active was addressed in Chomsky 1957. His analysis is summarized in (2):

- (2) Chomsky (1957: 42-43, 78-81, 112)  
If  $S_1$  is a grammatical sentence of the form  
NP<sub>1</sub> – Aux – V – NP<sub>2</sub>  
Then the corresponding string of the form  
NP<sub>2</sub> – Aux+be+en –V – by+NP<sub>1</sub>  
is also a grammatical sentence.

In this formulation, the passive is derived from the active, so that (3) is trivially true.

- (3) The external argument of the passive is projected in exactly the same way as the external argument of the active.

Chomsky (1957 : 42-43) gives a famous argument for the transformational rule in (2) based on selectional restrictions: “Finally, note that in elaborating (13) [C.C., a grammar containing only rewrite rules, no transformations] into a full-fledged grammar we will have to place many restrictions on the choice of V in terms of subject and object in order to permit such sentences as: ‘John admires sincerity,’ ‘sincerity frightens John,’ ‘John plays golf,’ ‘John drinks wine’, while excluding the ‘inverse’ non-sentences ‘sincerity admires John,’ ‘John frightens sincerity,’ ‘golf plays John,’ ‘wine drinks John’. But this whole network of restrictions fails completely when we choose *be + en* as part of the auxiliary verb. In fact, in this case the same selectional dependencies hold, but in the opposite order.”

Essentially, Chomsky argues for the transformational rule of the passive in (2) on the basis of selectional restrictions. The passive and the active show the same selectional restrictions, and this fact can be captured if the passive sentence is derived from an active sentence by transformation (which by implicit assumption does not change selectional restrictions).

In this monograph, I will argue for (3) (contra Bruening 2013, Legate 2014 and Alexiadou et. al. 2015), and show how (3) follows from UG principles (outlined in the next two sections).

The paradigm in (1) also raises the issue of implicit arguments. In (1c) an implicit argument can be detected through entailments. In this case, we have the entailment in (4):

(4) The book was written.  $\models$  Somebody wrote the book.

If it is true that the book was written, then it is true that somebody wrote the book. Because of this entailment, we know that there is an implicit argument in (1c). The question is what is the syntactic and semantic status of that implicit argument. Furthermore, what principles of UG determine the status of implicit arguments?

For Chomsky 1957, the implicit argument in the short passive came about by ellipsis:

(5) Chomsky (1957: 81, 89-90)  
“The sentences of (104) without the parenthetical expression are formed by a second ‘elliptical’ transformation that converts e.g., “the boy was seen by John” into “the boy was seen.”

For example, Chomsky (1957:89) discusses the following paradigm:

(6) a. The picture was painted by a new technique.  
b. The picture was painted by a real artist.

He comments as follows: “(113ii) [6b] is the passive of ‘a real artist painted the picture’. (113i) [6a] is formed from, e.g., ‘John painted the picture by a new technique’ by a double transformation; first the passive, then the elliptical transformation...that drops the ‘agent’ in the passive.” The point of the example is that the two sentences in (6) differ in the transformations that apply to derive them.

In the framework of Chomsky 1957, the only way to get an implicit argument in the passive is through ellipsis. So the implicit argument must have been syntactically projected (before being elided).

(7) The implicit argument in the passive is syntactically projected.

In this monograph, I will argue for (7) (again contra Bruening 2013, Legate 2014 and Alexiadou et. al. 2015), and show how it follows from UG principles (outlined in the next two sections).

## 1.2 Argument Introducing Heads

I adopt an approach to argument structure arising from Larson (1988), which showed that c-command asymmetries in double object constructions can be analyzed in terms of VP shells, where different arguments are introduced in different VP shells. Subsequent work developing that general framework includes Hale and Keyser (1993, 2002), Marantz (1993), Chomsky (1995), Collins and Thráinsson (1996), Kratzer (1996), Baker (1997), Travis (2000), Gruber (2001), Harley (2002, 2011, 2013), Borer (2005), Collins (2005), Pylkkänen (2008a) and Ramchand (2008) amongst many others. The fundamental assumption is that there is a series of verbal

projections that introduce arguments, including at least *v* and Appl. I will call these *argument introducing heads* (see Pyllkänen (2008a: 8) for more kinds of argument introducing heads).

Even though I focus mostly on *v* and Appl in this monograph, the results should apply generally to any system that uses such argument introducing heads. For example, the *Argument Criterion* below would also apply in Ramchand's 2008 system based on Init (initiator), Proc (process) and Res (result) projections (See Ramchand 2008: 60). Therefore, any such system (based on argument introducing heads) would need to adopt the conclusions in this monograph about implicit arguments, *by*-phrases and the role of voice.

The discussion in the monograph focuses mostly on external arguments (e.g., implicit external arguments and *by*-phrases), so I do not say much about internal arguments (e.g., themes, patients). For simplicity, I assume that there is a lexical transitive verb *write* which introduces an argument as a complement: [<sub>VP</sub> write [<sub>DP</sub> the book]]. This is a huge simplification. Rather, such arguments should also be introduced by various argument introducing heads in the spirit of Ramchand 2008, but I do not take up the issue here.

### 1.3 Principles of Argument Structure

In this section, I outline the principles relevant to deriving (3) and (7) above. First, I discuss the relationship between Merge and argument structure. Merge is defined as follows (see Collins and Stabler 2016 for a formalization):

$$(8) \quad \text{Merge}(A,B) = \{A,B\}$$

Chomsky (2005: 14, see also Chomsky 2004: 111, Chomsky 2008: 140, Chomsky 2021) observes that: "External Merge correlates with argument structure, internal Merge with edge properties, scopal or discourse related (new and old information, topic, etc.)." Strengthening Chomsky's observation, I propose that the only way to build argument structure is by Merge. I call this the *Merge-Based Theory of Argument Structure*. The core of this thesis can be formalized as follows:

(9) A head H introduces an argument A iff A externally merges with a projection of H.

(10) Argument Criterion

- a. Each argument is introduced by an argument introducing head.
- b. Each argument introducing head introduces an argument.

I take arguments to be non-expletive DPs (e.g., *John*, *nobody*, *the dog*, etc.), pronouns, KPs like (passive *by John*, to be discussed in chapter 5 and dative *to John* discussed in chapter 8) and some kinds of clauses (e.g., *that John is late*). AdjPs and other kinds of predicative expressions are not arguments. This list is sufficient for the purposes of the monograph, so I do not attempt a formal definition.

(10) is the fundamental thesis of the monograph. While it is simple and seemingly obvious, I will show that it has far-reaching empirical and theoretical consequences, and rules out many current analyses.

The Argument Criterion is closely related to the Theta-Criterion (on a recent revision of the Theta-Criterion see Chomsky 2021):

(11) Theta-Criterion (First Version)

Each argument bears one and only one theta-role, and each theta-role is assigned to one and only one argument. (Chomsky 1981: 36):

But the formulation in (11) raises difficult questions about individuating theta-roles. For example, what is the theta-role of *John* in “John deliberately rolled down the hill.”? Is *John* a theme, an agent, or some kind of composite (see Chomsky 1981: 139, fn. 14 for discussion). The formulation of the Theta-Criterion in Chomsky 1986 sidesteps this kind of question entirely by focusing on theta-positions, not theta-roles:

(12) Theta-Criterion (Second and Final Version)

Each argument  $\alpha$  appears in a chain containing a unique visible theta-position P, and each theta-position P is visible in a chain containing a unique argument  $\alpha$ .  
(Chomsky 1986: 97)

This formulation of the Theta-Criterion says nothing about particular theta-roles, or what a theta-role is or even that theta-roles exist. It does not presuppose a way to distinguish particular theta-roles (e.g., locations from goals, or themes from patients, or experiencers and causers from agents). Rather, it talks about theta-positions, which are just the external Merge positions of arguments. In other words, (12) forces the external Merge of arguments in certain positions.

The difference between the Argument Criterion and the second version of the Theta-Criterion is that the Argument Criterion focuses on the argument introducing heads. In effect, the argument introducing heads define the theta-positions. If the system were formalized (e.g., as in Collins and Stabler 2016), the Argument Criterion would be an axiom (a principle of UG), and the Theta-Criterion would be a theorem (derived from the Argument Criterion and other definitions and principles). I will not give a proof here. In this monograph, I will often discuss the Theta-Criterion since it is already widely referred to in the syntax literature. I will refer to AC/TC (Argument Criterion/Theta Criterion) where the difference between them is not relevant.

The Theta-Criterion is closely related to the configurational approach to theta-theory outlined in Chomsky (1995: 313) (see also Hale and Keyser 1993: 68, 69 for a related conception):

- (13) “A theta-role is assigned in a certain structural configuration;  
 $\beta$  assigns a theta-role only in the sense that it is the head of that configuration.”

Chomsky continues in the next paragraph: “...theta-relatedness is a property of the position of merger and its (very local) configuration.” The configurational approach has the following two properties:

- (14) a. There is a syntactic configurational relation between an argument and an argument introducing head.  
b. That relation is unique.

(14a) follows already from the Argument Criterion. But why is (14b) true? Why is the syntactic relation unique? Why couldn't there be several different syntactic relations between little

v and DP that would all yield an agentive interpretation. Here are some possible syntactic relations (I put aside adjunction structures):

- (15)
- a. DP is the complement of v.
  - b. DP is the first (inner) specifier of vP.
  - c. DP is the second specifier of vP.
  - d. DP is the third specifier of vP.
  - e. DP is the first specifier of the first specifier of vP.
  - f. DP is the second specifier of the first specifier of vP.
  - g. DP is the first specifier of the complement of v.
  - h. DP asymmetrically c-commands vP in a phase.
  - i. DP asymmetrically c-commands vP in a phase with no intervening DP.
  - j. DP asymmetrically c-commands vP in a clause.

In fact, there are an unlimited number of conceivable syntactic configurational relations between v and the external argument DP, so why is only (15b) chosen. The question is even more acute under a theory eliminating labels (Collins 2002) or introducing labels by a labeling algorithm (Chomsky 2013). In that kind of theory, Spec vP is undefined, rather Spec vP corresponds to the second merged XP:

- (16) {DP, {v, VP}}

So why is the DP in (16) the only possible argument position for v? First, I put aside the possibility of {VP, {v DP}} (VP is specifier). I assume that this configuration is never allowed. The generalization is approximately the following: In the extended projection of a verb V, the arguments introduced must c-command V. I put aside how this follows from general principles. Second, I speculate that the proximity of DP to v and the uniqueness of the position (Spec vP) are both the result of economy considerations. Basically, DP is being merged as close to v as possible (given that v takes a VP complement), and there is only one such closest position.

An alternative way to state the Theta-Criterion might be in terms of features, such as [+D] (requiring a DP argument). In effect, such an account would be treating the Theta-Criterion in terms of c-selection. However, I reject this alternative because it would allow different kinds of lexical items that should be excluded. For example, all of the following would be possible feature specifications for an argument introducing head: [+D], [(+D)], [-D], [+/-D]. Are all these different systems attested? Since the D is a category feature, presumably such an account would also allow any category label in these c-selection features. Also, there is other technology accompanying the use of features (e.g., feature inheritance, feature percolation, AGREE, valued versus unvalued features, interpretable versus uninterpretable features, feature deletion, etc.) that seems completely irrelevant to argument structure.

There are people who deny the existence of the Theta-Criterion (see chapter 9 for detailed discussion). For example, Bruening (2013: 23) gives the following statement (see also Heim and Kratzer 1998: 51):

- (17) “Because there are no syntactic thematic roles in this system, there is also no  $\theta$ -Criterion. Elements will either combine semantically, or they will not. If a head is a function that calls



for an argument and an argument of the appropriate type combines with it, the semantics will be well-formed. If a predicate calls for an argument and no argument combines with it, it will be ill-formed. If there is an argument that does not serve as the argument of any predicate in the semantics, the result will also be ill-formed. All the work of the  $\theta$ -Criterion is done by the semantics.”

A similar sentiment can be found in Myler (2021: 3) (see also Harley 2011: 430):

- (18) “Also, the Theta-Criterion has no status in this conception: all that is required is that the structure compose successfully in the semantics (Full Interpretation; see also Baker 1997: 121-122, Heim and Kratzer 1998: 53-58).”

Bruening and others try to make the case that the Theta-Criterion can be eliminated and replaced by the assumptions of formal semantics. Nothing more needs to be said. However, I will argue that analyses that do not assume the Theta-Criterion (e.g., the analysis of the passive in Bruening 2013) make the wrong empirical predictions with respect to the distribution of reflexives, Helke expressions and secondary predicates (see chapters 2 and 3). Therefore, the chapters of this monograph can be seen as a direct empirical argument for the Theta-Criterion. I return to a discussion of the tension between the Merged based approach to argument structure and formal semantics in chapter 9.

A direct consequence of Argument Criterion/Theta-Criterion is the following (see (7) above):

- (19) Implicit arguments are syntactically realized.

Here is the argument that (19) follow from the Argument Criterion in (10). Consider again the passive in (1). In the active in (1a), *John* is externally merged as Spec vP (by assumption). This reveals that little *v* is an argument introducing head (by (10a)). I assume that little *v* is also present in the passive (on the basis of semantic entailments and the possibility of a *by*-phrase). Furthermore, there is no special passive flavor of little *v*. Rather, the same little *v* is used in the passive and active. Therefore, in the short passive in (1c), little *v* must introduce an argument (by (10b)). Therefore, in (1c), there must be a syntactically present, but phonological null implicit argument.

Here is the parallel argument that (19) follows from the Theta-Criterion. Consider again the passive in (1). In the active in (1a), *John* is externally merged as Spec vP (by assumption). This reveals that Spec vP is a theta-position. I assume that little *v* is also present in the passive (on the basis of semantic entailments and the possibility of a *by*-phrase). Furthermore, there is no special passive flavor of little *v*. Rather, the same little *v* is used in the passive and active. Therefore, in the short passive in (1c), Spec vP is also a theta-position. Therefore, in (1c), there must be a syntactically present, but phonological null implicit argument.

The principle in (19) covers the implicit argument in the short passive, but other cases of implicit arguments as well (see Elbourne 2021 and Bhatt and Pancheva 2017 for surveys). Consider the following examples (see chapter 4 for more detailed discussion):

- (20) a. Libertarian doctrine never advocates the promotion of oneself at the expense of others.

- b. Letters to oneself compose quickly.  
(Stroik 1992: 129)
- c. It was upsetting to see herself in the newspaper.  
(see Landau 2010 and Epstein 1984 on control by experiencers)

The prediction of (19) is that all such implicit arguments are syntactically represented. In (20a), the noun *promotion* has an implicit external argument. We know that the implicit argument is syntactically present since it binds the reflexive *oneself*. Similarly, in (20b), the middle verb *compose* has an implicit external argument whose syntactic presence is felt as the antecedent for the reflexive *oneself*. Lastly, in (20c) *upsetting* has an implicit argument that controls PRO in the infinitival clause.

An important question is whether all such implicit arguments have the same syntactic and semantic properties or whether there are subtypes of implicit arguments. For example, is there a unified theory of licensing for all of implicit arguments in (20)? Are the implicit arguments in (20) syntactically active to the same extent? I will come back to these and other questions in chapter 4, where I present a theory of implicit arguments consistent with the AC/TC.

Another consequence of the Argument Criterion/Theta Criterion is that passive *by*-phrases are externally Merged into Spec vP. More generally the following principle holds:

- (21) KPs are arguments (and hence obey the Argument Criterion/Theta-Criterion).

A KP is a projection with a semantically vacuous head (e.g., passive *by*, dative *to*, some uses of *of*) that is part of the extended projection of the DP. In the context of the passive, (1) makes the claim that the *by*-phrase is an argument (see (3) above). In the active in (1a), *John* is externally merged as Spec vP (by assumption). This reveals that Spec vP is a theta-position. Therefore, in the passive in (1c), Spec vP is also a theta-position. Therefore, in (1c), the *by*-phrase is externally merged into Spec vP (satisfying the AC/TC).

Lastly, this monograph will discuss the relation between voice and argument structure with the following conclusion (contra Kratzer 1996, Pytkänen 2008a, Bruening 2013, Legate 2014, Alexiadou et. al. 2015 and Sigurðsson and Wood 2021).

- (22) Voice is independent of the projection of arguments.

Although I only discuss passive voice in the monograph, I give the formulation in (22) covering all kinds of voice (active, middle, nonactive, antipassive, inverse, etc.). Basically, the arguments are projected in exactly the same way in the active and the passive. Based on the empirical evidence I give, it is not the case that the external argument is projected in the active, while remaining unprojected in the passive. Therefore, voice is independent from the projection of external arguments, and more generally, independent from argument structure.

Why is voice independent of argument structure? Why doesn't UG allow for the external argument to be projected in Spec VoiceP (allowing for many different kinds of interactions between voice and the projection of the external argument)? I argue that the AC/TC severely limits the way in which arguments can be projected. The kinds of analyses proposed in the literature involving VoiceP projecting an external argument violate the AC/TC. I return to a detailed discussion in chapter 7.

See the conclusion in chapter 10 for a more detail exposition of the principles of argument structure argued for in this monograph.

## 1.4 Overview of Monograph

In chapter 2, I investigate the phi-features of the implicit argument in the short passive in English, using the distribution of reflexives and bound pronouns (Helke expressions) as diagnostics. I show that there are three cases: (a) null versions of generic *one* and *you*, (b) a null existential quantifier phrase lacking phi-features, and (c) a null definite *pro* with any combination of phi-features. This chapter supports the claim that the implicit argument in the short passive is syntactically projected (contra Alexiadou et. al. 2015, Bruening 2013, Legate 2014 and Pylkänen 2008).

In chapter 3, I discuss the distribution of secondary predicates in the short passive. Based on a systematic discussion of the existing literature, and new data from the internet, I establish that secondary predicates can modify the implicit argument in the short passive (contra Pylkänen 2008). The results of chapter 3 converge with those of chapter 2, since both chapters argue that the short passive contains a syntactically projected implicit argument.

In chapter 4, I embed the results of chapters 2 and 3 in a general theory of implicit arguments. I argue that implicit arguments are syntactically projected, including implicit arguments with evaluative predicates, middles, nominalizations and passives. I propose that implicit arguments are covert pronominals (*pro*) lacking a structural Case feature.

In chapter 5, I discuss the *by*-phrase in the passive. A common position taken in recent literature on the passive is that *by*-phrases are adjuncts (Bruening 2013, Legate 2014). Chapter 5 shows that passive *by*-phrases differ from adjuncts in terms of binding phenomena. From these facts, I conclude that *by*-phrases are not adjuncts, but rather arguments. I briefly report on data from Angelopoulos, Collins and Terzi (2020) on Modern Greek that reaches the same conclusion. The conclusions of chapter 5 dovetail with the conclusions of chapters 2 and 3 by showing that the passive always has a syntactically projected external argument (whether or not a *by*-phrase is present).

Chapter 6 puts all the results of the preceding chapters together, and gives full derivations of several passive sentences, stating clearly all the technical assumptions, and discussing several differences from Collins (2005).

In chapter 7, I compare two distinct conceptions of VoiceP. On one conception, the external argument is projected (externally merged) into Spec VoiceP (Kratzer 1996). On the other conception, VoiceP plays no role in the projection of arguments, but determines how the arguments are realized in various A-positions. I dub these two theories the Projection Theory and the Realization Theory respectively. I present several empirical reasons for preferring the Realization Theory. Basically, since the external argument is projected in the same way in the active and the passive, there is no reason to assume that the external argument is externally merged in Spec VoiceP (where its occurrence would naturally depend on the particular kind of Voice head). Furthermore, I attempt to show that the Projection Theory is inconsistent with the AC/TC.

In chapter 8, I give an analysis of the dative alternation, which I analyze as a kind of “inner passive”. On the basis of traditional c-command tests, I show that the prepositional dative is derived from an underlying structure where the goal is projected higher than the theme. Just as with the passive, I motivate a smuggling analysis, where a VP containing the theme is moved over the goal. I present additional evidence for this analysis from Hallman (2015).

In chapter 9, I discuss the tension between the AC/TC and a theory of argument structure constrained only by formal semantics. First, I respond to Heim and Kratzer’s (1998) critique of the Theta-Criterion, and point out some problems with their arguments. Second, I discuss a range of cases in the syntax/semantics literature where people have relied heavily on formal semantics to explain argument structure phenomena. Third, I discuss the status of UTAH in the Merge-based framework. Lastly, I outline the main conceptual problems with adopting formal semantics as the basis for a theory of argument structure.

Chapter 10 is the conclusion. I summarize the principles discussed throughout the monograph.

## 2 On the Phi-Features of the Implicit Argument in the Passive

### 2.1 Introduction

It has been claimed in the generative syntax literature that the implicit argument of a short passive can bind a reflexive pronoun. Some cases are listed below:

- (1) a. Such privileges should be kept to oneself.  
(Baker, Johnson and Roberts 1989: 228, Roberts 1987: 162))
- b. Damaging testimony is always given about oneself in secret trials.  
(Roberts 1987: 162)

Since reflexive pronouns are subject to Principle A of the Binding Theory, these examples suggest that the implicit argument of the short passive is syntactically present.

Principle A is stated for convenience as follows:

- (2) Principle A: An anaphor must be bound in its domain.  
(Sportiche, Koopman and Stabler 2014: 168)

Such a conclusion about the sentences in (1) is contrary to recent claims by Bruening 2013, Legate 2014 and Alexiadou et. al. 2015 that there is no syntactically represented implicit argument in the short passive. Rather, on these theories, the implicit argument is not syntactically projected, but is semantically existentially closed.

Some quotes illustrating these claims are given below:

- (3) Bruening (2013: 22)  
“I propose that passive is a head (Pass) that selects a projection of Voice that has not yet projected its external argument.”
- (4) Legate (2014: 141)  
“In chapter 2, I argued for a new analysis of the implicit initiator in passives: this is present on the Voice head, both as a T-role, introduced but not assigned to any DP, and as features restricting this T-position.”

But the data in (1) is incompatible with such analyses. Since a reflexive pronoun requires a syntactic antecedent, the passive verbs in (1a,b) need syntactically present external arguments.

Alexiadou et. al. (2015: 131) suggest for data like (1) that: “...the English data might also find a quite different explanation, as they could arguably involve a logophor instead of an ordinary reflexive pronoun.” (see also Reed 2011)

However, no such approach will work for example (1a) for the simple reason that the reflexive in this example cannot be analyzed as a logophor or an exempt anaphor. One generalization about exempt anaphors is that they can always be replaced by pronouns with the same truth conditional meaning. So, in each of the following standard examples (see for example Charnavel and Zlogar 2015 for a recent discussion of exempt anaphora in English), the exempt anaphor can be replaced by a pronoun, while maintaining the truth-conditions.

- (5) a. Bill<sub>1</sub> said that the rain had damaged pictures of himself<sub>1</sub>/him<sub>1</sub>.
- b. In her<sub>1</sub> opinion, physicists like herself<sub>1</sub>/her<sub>1</sub> are rare.
- c. Max<sub>1</sub> boasted that the Queen invited Lucie and himself<sub>1</sub>/him<sub>1</sub> for a drink.

But no such replacement works with *to keep privileges to*:

- (6) John<sub>1</sub> kept those privileges to himself<sub>1</sub>/\*him<sub>1</sub>

The reason for this is that *to keep privileges to* is a fixed expression requiring a reflexive pronoun that is bound by the external argument. Therefore, in example (1a) (also involving the expression *keep privileges to*) the reflexive must be a regular locally bound reflexive, not a logophoric or exempt anaphor. Therefore, example (1a) requires the existence of a syntactically present implicit argument.

But the presence of a syntactically present implicit argument in short passives raises the question of what the possible phi-features of that implicit argument are. In this chapter, I sort through the various possibilities, and show that there are basically three cases: (a) null versions of generic *one/you*, (b) a null existential quantifier expression lacking phi-features, and (c) a null definite pro with any combination of phi-features.

In section 2, I give further examples like those above involving *oneself*. In section 3, I discuss existential implicit arguments. In section 4, I discuss a new class of cases that has, not to my knowledge, been previously discussed, where the implicit argument is a definite pronoun. Section 5 addresses the issue of whether the implicit argument of the passive can be bound. Section 6 addresses the issue of whether there are any animacy restrictions on the implicit argument of the passive. Section 7 is the conclusion.

## 2.2 Generic *one* and *you*

It is relatively easy to find examples involving *oneself* like (1) on the internet. A few such examples are given below:

- (7) Increased privacy and individuality result in more time spent on oneself.  
(<https://www.sciencedirect.com/science/article/pii/S2452315116000035>)
- (8) Anything done for another is done for oneself.  
([https://en.wikiquote.org/wiki/Talk:Pope\\_John\\_Paul\\_II](https://en.wikiquote.org/wiki/Talk:Pope_John_Paul_II))
- (9) Depression is anger turned against oneself.  
([http://www.parentingmatters-epc.org/wp-content/uploads/2017/10/18\\_suicide.pdf](http://www.parentingmatters-epc.org/wp-content/uploads/2017/10/18_suicide.pdf))
- (10) An email sent to oneself as a “memo to file” is considered a university record if it documents university business.  
(<http://ipo.info.yorku.ca/tool-and-tips/tip-sheet-5-email-management/>)
- (11) We know that, in general, humor aimed at oneself is well received by others.  
(<https://www.aath.org/levity-defies-gravity-using-humor-in-crisis-situations>)

- (12) Therefore, certain private matters must be kept to oneself and remain untouched.  
(<https://books.google.com/books?isbn=0857720147>)
- (13) If feelings and emotions and fears and frustrations are to be kept inside oneself, those emotions are often also kept away from God.  
(<https://books.google.com/books?isbn=1929626177>)
- (14) If there is one thing any artist knows, it is that art - whatever form it takes - cannot be kept inside oneself.  
(<https://janepenfield.com/blog/77021/i-have-had-singing>)

These examples are all acceptable to the current author. And in each case, the antecedent of the reflexive is clearly the implicit argument of the short passive, as indicated by the interpretation. For example, in (10) the sender (the implicit argument) and the receiver (*oneself*) are the same person. The sheer number of such examples, and the ease with which they are found on the internet makes it impossible to claim that (1a,b) above are infrequent fixed expressions (and hence ignorable when constructing a theory of UG). Rather, the examples in (7-14) suggest that principles of UG must make it possible for the implicit argument in the passive to bind a reflexive.

What phi-features are involved in these kinds of examples? First, *oneself* is singular (as indicated by the use of the form *oneself*, rather than *oneselves*). Second, it is third person (with a semantic connection to the speaker, as described by Moltmann 2006). Third, it is human and animate. Fourth, it has a feature [+generic] (following Moltmann 2006: 262, see also Rizzi 1996: 512), which I will analyze as a kind of phi-feature (since it determines the form of the pronoun *one*). Moltmann claims that “Formally this means that generic *one* as well as arbitrary PRO should carry the feature [+gn] as a formal agreement feature which will require those pronominal elements to be bound by a generic operator carrying that feature as well (but as an interpretable feature).” I follow Moltmann in all these assumptions.

According to Moltmann (2006: 260): “Generic *one*, we can thus say, acts as a variable ranging over individuals, a variable bound not by a universal quantifier, but rather by a generic quantifier that allows for exceptions and has itself modal force. Without going into any further detail about the nature of that quantifier, let us simply say it is the generic quantifier Gn as commonly used in the linguistic semantic literature on generic sentences (cf. Krifka et. al., 1995).”

Putting these ideas together, I assume that the implicit argument in the short passive in these cases is a null version of the pronoun *one*, which I will call ONE (on null generic pronouns see Rizzi 1996, on “pronouns with arbitrary reference” see Chomsky 1996: 117). In interpretation, this null pronoun is very closely related to PRO<sub>arb</sub> from the syntax literature on non-obligatory control.

- (15) Generic Implicit Argument ONE:
- a. ONE is a DP
  - b. Phi-features: third person, singular, human, animate, generic
  - c. Interpretation: ONE is of type <e> and is bound by a generic operator Gn.

A partial tree diagram for examples like those in (1a) is the following:

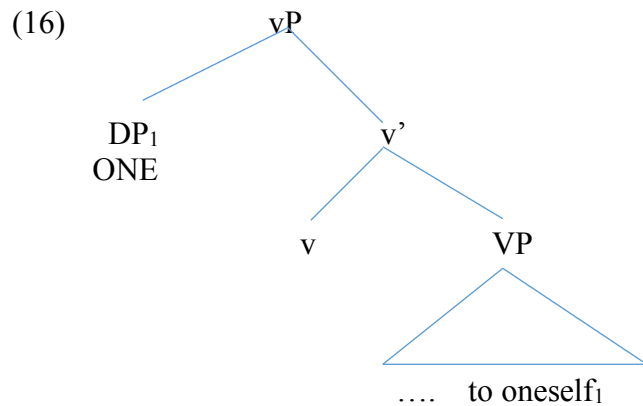

Crucially, the reflexive and the implicit argument agree in phi-features. I assume that this agreement is governed by the Pronominal Agreement Condition:

- (17) The Pronominal Agreement Condition (PAC)  
 An anaphor agrees in phi-features with its antecedent.  
 (see Collins and Postal 2012: 92, Sportiche, Koopman and Stabler 2014: 160)

The reflexive *oneself* in (16) is locally bound and agrees in phi-features with its antecedent. That is why (1a) is grammatical.

The second person singular pronoun *you* occurs in generic contexts as a colloquial substitute for *one*. There are examples that correspond to those in (7-14) using second person reflexives:

- (18) Time spent on yourself is time well spent.  
 (<https://carsontate.com/work-life-balance-how-to-balance-your-life-like-the-four-seasons/>)
- (19) Some things are better kept to yourself.  
 (<https://www.facebook.com/GriffinsNZ/...kept-to-yourself.../1253558661331547/>)
- (20) In the case of an e-mail sent to yourself, it decides to show it in Inbox, even if its true location is in Sent Mail.  
 (<https://github.com/nylas/nylas-mail/issues/2456>)

Like earlier *one* examples, these reflexives cannot be analyzed as exempt anaphors. First, example (19) involves the fixed expression *keep x to self* which does not allow a logophoric or exempt anaphor (see the discussion of (6) above).

Second, replacing the reflexive with a non-reflexive pronoun yields a different interpretation, which would not be predicted if the reflexives were exempt anaphors. Consider the result of replacing *yourself* by *you* in example (20):

- (21) In the case of an e-mail sent to you, ...



In (21) the sender of the e-mail is different from the recipient. This clearly contrasts with the interpretation of (20), where the sender is the same person that *yourself* refers to. The disjoint reference in (21) follows from Condition B: \*[In the case of an e-mail sent  $pro_1$  to  $you_1$ ].

Because of these examples, we can adjust (15) to also include second person singular generic pronouns.

### 2.3 Existential UN

Consider now the following non-generic examples of passives:

- (22) a. The proposal was criticized at the meeting.  
b. The package was sent this morning.  
c. John was killed this morning.

(22a) can be true if either a man or a woman criticized the proposal. Furthermore, it can also be true if either one person or more than one person criticized the proposal. Similarly, I can say (22b) to my boss if I myself have sent the package (with my boss understanding that nobody but me could have sent the package). So (22b) does not exclude the speaker from being the sender (see also Bianchi 2015: 6). Sentence (22c) is consistent either with a report of a murder (animate agent), or death by a natural force (inanimate causer). These sentences show that the implicit argument is either ambiguous in its feature specifications for the phi-features person, number, gender and animacy, or unspecified for those feature values. In this section, I will argue that the existential implicit argument is unspecified for phi-feature values.

These observations are consistent with McCawley's (1988: 82) remarks about implicit arguments in passives:

- (23) "If reduced passives are to be analyzed as having underlying subjects, the underlying subject must be something more indefinite than any expression of English is: it must be neutral with regard to whether it refers to human or non-human entities, and with regard to whether its referent is the same as or different from other individuals mentioned in the discourse. I will invoke a *deus ex machina* at this point and simply assume that such an element, hereby christened UNSPEC, is available, and will set up deep structures having UNSPEC as subject in the case of reduced passives..." (McCawley 1988: 82)

I will call the existential implicit argument in short passives UN (for unspecified) (following Johnson and Postal (1980)).

As Grinder (1971: 186) has pointed out, there is a striking difference between the implicit argument of a passive and an overt indefinite. The following sentences are based on his examples:

- (24) a. Someone<sub>1</sub> stole the painting, and he<sub>1</sub> left his fingerprints on the wall.  
b. The painting was stolen by someone<sub>1</sub>, and he<sub>1</sub> left his fingerprints on the-wall.  
c. The painting was stolen and he left his fingerprints on the wall.

Although *someone* can be the antecedent of *he* in (24a,b) it is much more difficult for the implicit argument in the passive to be the antecedent of *he* in (24c). Grinder (1971) explains this difference in terms of his Chaining Constraint which informally says that if an indefinite is the

antecedent of a pronoun, then the indefinite cannot undergo deletion (where implicit arguments are assumed to be indefinites that undergo deletion).

The contrast can be replicated with intra-sentential anaphora:

- (25) a. If somebody<sub>1</sub> sends an e-mail to his<sub>1</sub> mother, how long does it take to arrive?  
b. If an e-mail is sent to his mother, how long does it take to arrive?

Example (25b) cannot have the same interpretation as (25a), suggesting that the implicit argument of the passive cannot bind the possessive pronoun *his* in (25b). What accounts for this constraint?

Koenig (1998), Koenig and Mauner (2000) and Creissels (2008) (see also Kayne 1975: 196, fn. 154 on intra-clausal anaphora) have noticed a similar constraint on the impersonal pronoun *on* when it is used existentially in French. In fact, Koenig (1998: 243) himself makes this connection: “I close this section by pointing out the strong similarities between French ultra-indefinite *on* and (prototypical) short passives.” It is possible that the explanation I give for (24) and (25) below in terms of the PAC in (17) can be carried over to the anaphoric possibilities with *on*.

I suggest that the facts in (24) and (25) can be explained in terms of the PAC in (17) on the assumption that UN, the implicit existential argument in the short passive, does not have any phi-features (cf. Bianchi 2015: 8 who reaches the conclusion that the implicit argument of the passive is not specified for participant features). The relevant part of the structure of (25b) will be the following (I assume UN linearly follows participle, just as an overt *by*-phrase would):

- (26) \*If an e-mail is sent UN<sub>1</sub> to his<sub>1</sub> mother....

But since UN does not have phi-features, (26) violates (17) requiring phi-feature agreement between the possessive pronoun *his* and its antecedent UN.

I assume that UN’s lack of phi-features is the reason that it can be used in such a wide variety of situations, as described in (22-23). Essentially UN is an unrestricted existential quantifier. The assumptions about UN are summarized below:

- (27) Existential Implicit Argument UN:  
a. UN is a DP  
b. Phi-features: none  
c. Interpretation: existential quantifier of type  $\langle\langle e,t \rangle, e \rangle$ .

English has a variety of contexts permitting null existential quantifiers. For example, Collins and Postal 2014 analyse negative existentials such as *no boy* as having the structure  $[[\text{NEG SOME}] \text{boy}]$ , where SOME is a covert existential quantifier. The claim of (27) is that the implicit argument of the passive can also be a null existential quantifier.

A closely related proposal would be to assume that UN has no phi-features, but it is existentially bound by some quantificational element in the tree. In other words, UN would not be an existential quantifier phrase, but rather a null pronoun. On existential closure, see Legate (2014: 2): “The semantic interpretation of this external argument position as existential (e.g., ‘Something bit me’ approximates ‘I was bitten’) is accomplished through existential closure (Landau 2009, Bruening 2013, pace Collins 2005).” One way to implement existential closure in the framework

of Collins 2005a is to assume that Voice can existentially bind the null implicit argument. I discuss this issue further in chapter 4.

A third theory is that on the existential interpretation of the passive, there is no syntactically realized implicit argument at all. I will call this the non-projection theory. In this case, Spec vP is empty. Such a theory would automatically account for Grinder's generalization. Since Spec vP is empty, there is no antecedent for a pronoun. I reject this analysis since it is not uniform with the other cases discussed in sections 2 and 4, which involve binding DP pronouns. In my analysis, in all cases there is a syntactically projected DP as the implicit argument.

Another reason to reject the non-projection theory is that UN plays a role in obligatory control:

- (28) Once it had been decided to build a walled enclosure, new possibilities opened up.  
([www.paulgough.org/places\\_of\\_peace/sites.htm](http://www.paulgough.org/places_of_peace/sites.htm))

In this example, the implicit external argument of *decided* controls PRO of the infinitival complement of *decided*. Furthermore, the implicit argument seems to be existential (as opposed to generic or definite). If obligatory control is a syntactic phenomenon, then this example argues against the non-projection theory of implicit arguments.

## 2.4 Definite pro

Helke 1973 investigated a class of possessor pronouns that have the requirement of being bound locally. Consider the following example of the idiomatic expression *to lose one's mind* (see Helke 1973: 11):

- (29) a. \*The lady hopes that the gentleman won't lose her mind.  
b. \*The man who found the girl lost her mind.  
c. \*The girl's father lost her mind.  
d. \*The girl and the boy lost her mind.

Example (29a) shows that there is a locality (clausemate) constraint on the relation between *her* and its antecedent *the lady*. (29b,c,d) show that there is a c-command condition. I will call such pronouns bound possessor pronouns.

From this point of view, consider the expression *on my own* in the following examples:

- (30) a. I did the homework on my own.  
b. \*I did the homework on John's own.  
c. \*Mary said I did the homework on her own.  
d. \*John's mother did the homework on his own.  
e. \*Somebody did the homework on my own.  
f. \*It rained on my own.

(30a) shows the use of *on my own*. (30b) shows that the possessor must be a pronoun bound by the subject. (30c) shows a locality effect: (30c) is only acceptable if *on her own* modifies the matrix VP, not the embedded VP. (30d) illustrates a c-command effect: *his* is not c-commanded

by *John*, and so the sentence is unacceptable. In (30e,f), there is no possible local antecedent for the possessor.

So the following generalization appears to hold:

(31) In the expression *on X's own*, X is a locally bound pronominal possessor.

Given this condition, consider the following example:

(32) A: Did you get help on this assignment?  
B: No, it was done on my own.

While B's response might be a bit awkward, it is grammatical. It may improve if certain modifiers like *completely* or *all* are added before *on my own*. In an informal Facebook survey, out of eight native speakers of English, four said it was fine, and four others rejected it to varying degrees (ranging from ? to \*). So there is definitely some variation that would be worth investigating.

Assuming that (32B) is acceptable, given condition (31), there must be an implicit argument binding the possessor *my*. Therefore, by condition (17), that implicit argument must be a first person singular pronoun.

Such examples do not seem any worse with other person-number combinations:

(33) a. It was done on your own, right?  
b. It was done on his own, right?  
c. Homework done on one's own is never easy.

Related examples appear on the internet:

- (34) I'm not even going to lie, but the solo has been the hardest to create and perform as everything was done on my own.  
(<https://www.mandy.com/news/dancer-yukiko-masui-interview-hip-hop-contemporary>)
- (35) This was done on my own time and with no reimbursement for my gasoline.  
(<https://books.google.com/books?isbn=311097391X>)
- (36) Occasionally, he was able to study formally with an accomplished artist, but much of his training was done on his own.  
(<https://helpinghandhomeschool.com/vincent-van-gogh-artist-study-activities/>)
- (37) This work was written on my own during the summer and fall of 1963,...  
([www.smcq.qc.ca/smcq/en/oeuvres/216/87.php](http://www.smcq.qc.ca/smcq/en/oeuvres/216/87.php))
- (38) First, the research framework was created on my own.  
([pub.lib.aalto.fi/en/ethesis/pdf/12502/hse\\_ethesis\\_12502.pdf](http://pub.lib.aalto.fi/en/ethesis/pdf/12502/hse_ethesis_12502.pdf))

The distribution of bound possessor pronouns in the short passive shows that there is another kind of implicit argument, described in (39). I use the term *definite* to distinguish these cases from the generic and existential implicit arguments discussed in sections 2 and 3.

- (39) Definite Pronominal Implicit Argument (Null pro):
- a. Null pro is a DP
  - b. Phi-features: any non-null combination of phi-features (other than [+generic])
  - c. Interpretation: Null pro is of type <e>.

But if such definite pronominal implicit arguments are possible, can they bind reflexive pronouns? Consider first the following examples involving first and second person reflexives:

- (40) I cannot receive emails sent to myself from Outlook though they appear in Webmail (<https://crowdsupport.telstra.com.au/t5/Telstra-Mail/I-cannot-receive-emails-sent-to-myself-from-Outlook-though-they/td-p/770123>)
- (41) The time spent on myself daily was like giving myself a big hug. (<https://nsmh.org/images/docs/nsmh-program-guide-2018-ver2.pdf>)
- (42) Most of this blog is self-deprecating humor aimed at myself as much as others. (<http://eveoganda.blogspot.com/2016/01/rixx-in-local.html>)
- (43) Please understand that my family does not excuse her mistakes. She knows she made them, and she knows that she should not have gotten pregnant so young. I would really appreciate it if any negative feelings you have toward teen mothers were kept to yourselves. (<https://www.disboards.com/threads/the-multi-reason-special-family-wdw-trip.1800085/>)

It is also possible to find third person reflexives bound by the implicit argument of the passive:

- (44) In a blistering farewell e-mail sent to himself, Jones defended his stance against further cuts. (<http://www.nottheletimes.com/fired.html>)
- (45) He is so self involved he could not even think of a title for a song dedicated to himself other than his own name. (<https://www.thequiz.com/finish-the-lyrics-disney-edition/>)
- (46) Gore delivered the message with a mix of seriousness, humor aimed at himself and measured alarm. (<https://newspaperarchive.com/santa-ana-evening-blade-aug-28-1996-p-13/>)
- (47) Rumor has it that Mike Tyson bought over 200 cars throughout his career, totaling at \$4,5 million. Many were bought for himself and others as gifts for his friends and family. (<https://gazettereview.com/2016/06/mike-tyson-net-worth/>)

- (48) His interest in hockey, soccer and chess was never displayed and *was kept to himself*.  
([www.biography.co.in/justin-bieber-biohraphy.html](http://www.biography.co.in/justin-bieber-biohraphy.html))

I did an informal survey of seven people on these sentences. I asked them to rate the sentences from 1 (acceptable) to 5 (unacceptable). Every sentence had an average less than 2: (40: 1.7), (41: 1.7), (42: 1), (43: 1), (44: 1.4), (45: 1), (46: 1.1), (47: 1) and (48:1.1). Furthermore, for almost every sentence and every speaker, the most natural interpretation was that the implicit argument binds the reflexive.

The implicit argument in the passive also gives rise to Condition B effects. For example, in the phrase “In a blistering farewell e-mail sent to him...” (compare to (44)), the most natural interpretation is that the sender (the implicit argument) is not the recipient (*him*). This is exactly the expected interpretation if there is an implicit argument giving rise to a Condition B effect: \*[in a blistering farewell e-mail sent  $pro_1$  to  $him_1$ ].

In fact, there are examples where the implicit argument has a quantificational antecedent, and so it is interpreted as a bound variable (which in turn binds the reflexive).

- (49) Every corporate manager has been advised that emails sent to himself can be used as incriminating evidence.

Many (but not all) of the examples are reduced relatives modifying nouns. For example, in (40) the reduced relative *sent to myself* modifies *e-mails*. I leave it to further work to find out why it is easier to find examples of this type.

Note that in these cases it is not possible to describe the implicit argument as logophoric. For example, in (47) the implicit argument is not describing the thoughts of Mike Tyson. Rather, the sentence describes the thoughts of the narrator discussing Mike Tyson. Consider also example (48) once again using the fixed expression *keep x to self*. This expression does not allow a logophoric or exempt use (see the discussion of (6) above). Furthermore, the expression *on my own* does not seem to allow any long-distance binding at all (unlike reflexives).

A similar test for the implicit argument can be found in Stroik (2000: 148-157), who gives the following example (see page 148, example (15)):

- (50) a. John<sub>1</sub>'s first novel was translated into Polish by himself<sub>1</sub>.  
b. Pat<sub>1</sub> told me that her<sub>1</sub> father was fired by herself<sub>1</sub>.  
c. Such things are to be done by yourself.

Stroik argues convincingly that the *by*-phrases here are what he calls agent-related manner adverbials that you find in non-passive examples like those in (51). The presence of *all* in the examples in (51) is an important test distinguishing the manner adverbial from the passive *by*-phrase:

- (51) a. I did it (all) by myself.  
b. Mary translated the book into Polish (all) by herself.

As Stroik shows, the reflexive in these agent-related manner adverbials obeys Principle A of the binding theory (see page 151, example (22)):

- (52) a. \*John did it (all) by myself.  
 b. I<sub>1</sub> did it (all) by myself<sub>1</sub>.  
 c. \*Mary wrote it (all) by yourself.  
 d. You<sub>1</sub> wrote it (all) by yourself<sub>1</sub>.  
 e. \*Mary's father translated the book (all) by herself.  
 f. Mary<sub>1</sub> translated the book all by herself<sub>1</sub>.

For example, the reason that (52e) is ungrammatical is that the reflexive does not have a c-commanding antecedent. In this explanation, I employ the standard binding theory, in contrast to Stroik who makes reference to Reinhart and Reuland 1993. The difference does not matter for the points that I am raising.

He goes on to argue that the reflexives in (50) take the implicit argument in the passive as their antecedent, with the following representations (see page 155, example (24)):

- (53) a. John's first novel was translated into Polish PRO by himself.  
 b. She told me her father was fired PRO by herself.  
 c. Such things are to be done PRO by yourself.

Crucially, Stroik's conclusions only hold if the implicit argument of the passive is like a definite pronoun with the phi-feature sets 3.MASC.SG (see (50a)) and 3.FEM.SG (see (50b)). In principle, the 2SG phi-features in (50c) are ambiguous between an indexical use and a colloquial generic use.

Putting together the results from the Helke expressions, from reflexive pronouns and from agent-oriented manner adverbials, I conclude that the implicit argument can be a null pro with any combination of phi-features. A partial syntactic tree for an example like (44) would be:

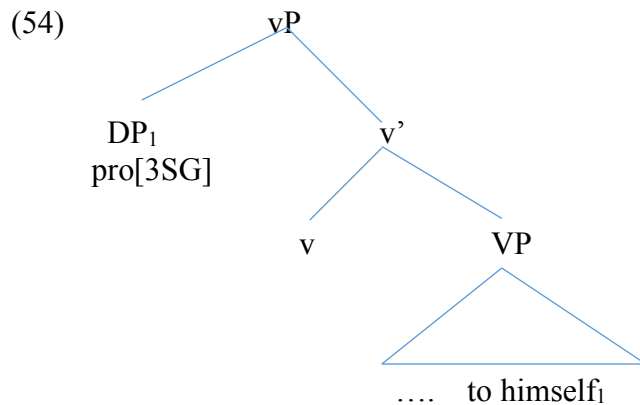

Putting together the results of section 3 and the current section, the prediction about the interpretation of these reflexive pronouns is the following:

- (55) a. An existential implicit argument cannot bind a reflexive, or equivalently:  
 b. If a reflexive is bound by an implicit argument, the implicit argument is not understood existentially.

It is clear in all of the above cases that the implicit argument is not understood existentially. For example, in (47) *himself* refers to the buyer, who is Mike Tyson.

## 2.5 Binding the Implicit Argument

In the preceding sections, I investigated the kinds of pronouns that an implicit argument can bind. A parallel question is whether the implicit argument can be bound. Consider the following example (see Baker, Johnson and Roberts 1989: 226 for an analysis of similar facts based on the definition of chains):

- (56) John was killed.  
a. John was killed by somebody.  
b. Not: John killed himself.

Since (56) is not a generic sentence, the implicit argument could only be UN or null pro. But UN would yield the interpretation in (56a), not (56b).

Now consider the possibility of null pro (once again, the implicit argument is placed linearly in the same position as a *by*-phrase would be):

- (57) John<sub>1</sub> was killed pro<sub>1</sub>.

While this representation yields the interpretation in (56b), it violates Condition B of the binding theory. So it follows that (56a) and not (56b) is the right interpretation of (56).

Williams (1987: 155) claims that the implicit argument in the passive is never bound (see also Bruening 2013: 19, Bhatt and Pancheva 2017: 16). Consider the following sentence:

- (58) John wants Mary to be seen.

About (58), Williams says:

- (59) “When an implicit argument is existentially quantified, it acts like an R expression, in that it is disjoint from c-commanding NPs...The unassigned Agent is understood as disjoint from John, or at least is vague on that point in the same way that John wants Mary to be seen by somebody is; neither means John wants to see Mary.”

This result is perplexing from the point of view of the present analysis. (60a) (with the interpretation of (60b)) should be a possible representation of (58):

- (60) a. John<sub>1</sub> wants Mary to be seen pro<sub>1</sub>.  
b. John<sub>1</sub> wants Mary to be seen by him<sub>1</sub>.

But (58) does not seem to have the interpretation in (60), rather (58) seems to have the same interpretation as:

- (61) John wants Mary to be seen by somebody.



But there are other cases where sentences similar to (58) have an interpretation where the implicit argument is identical to the matrix subject. Consider:

- (62) a. I set myself some health-related goals and I want those goals to be met by the new year.
- b. I plan on going on vacation to Jamaica this summer, so I want all revisions to be made on my thesis before then.

In these cases, the implicit argument is taken to be identical with the matrix subject. No other interpretation makes sense. How could I want somebody else to meet my health goals? However, (62) could still be consistent with William's claim in that what is expressed is that the speaker wants somebody to meet those goals, and the only person who could possibly meet them is the speaker.

More convincingly, there are embedded passive sentences involving reflexives and bound possessor pronouns that do allow the matrix subject to bind the implicit argument of the passive:

- (63) He reveals to Skyler in the end that everything was done for himself, as it made him feel alive.  
([villains.wikia.com/wiki/Walter\\_White](http://villains.wikia.com/wiki/Walter_White))
- (64) He is so self involved he could not even think of a title for a *song dedicated to himself* other than his own name.  
(<https://www.thequiz.com/finish-the-lyrics-disney-edition/>)
- (65) John<sub>1</sub> thought that a friendly e-mail sent to himself<sub>1</sub> would cheer him<sub>1</sub> up.

In (65), the antecedent of *himself* is the implicit argument of *send*, and that implicit argument takes *John* as an antecedent, a clear counter-example to William's generalization in (59).

How then can we account for William's observations about the interpretation of (58)? I suggest that the definite pro interpretation of the implicit argument is made clear when the implicit argument binds a reflexive or a pronoun. So in (65), the implicit argument is pro[3SG] and it binds the reflexive pronoun *himself*. In William's example (58), the implicit argument does not bind a reflexive or a pronoun, so only the existential interpretation is possible (even preferred).

Now consider again the contrast in (25) repeated below as (66):

- (66) a. If somebody<sub>1</sub> sends an e-mail to his<sub>1</sub> mother, how long does it take to arrive?
- b. If an e-mail is sent to his mother, how long does it take to arrive?

Recall that (66b) lacks the interpretation of (66a). I accounted for this by claiming that the implicit argument in (66b) is UN. But now there is an alternative representation:

- (67) If an e-mail is sent pro<sub>1</sub> to his<sub>1</sub> mother....

Nothing rules out representation (67). The possessor *his* could agree in phi-features with its null pro antecedent. And I believe that in the right context (66b) has this interpretation. But for (66b) presented out of the blue (with no linguistic context) and especially in comparison with

(66a), the most natural interpretation is the one where the implicit argument is existential UN. And in that case, (66b) (with the interpretation of (66a)) is unacceptable (because it violates the PAC in (17)).

## 2.6 The Inanimacy Gap

Can the null definite *pro* be an inanimate pronoun? It is difficult to find relevant examples. One way to try would be to first look for examples with an inanimate *by*-phrase binding a reflexive, and then drop the *by*-phrase. Consider the following internet examples (from Angelopoulos, Collins and Terzi 2018):

- (68) You find yourself rising and being pulled by the sun toward itself.  
(<https://www.do-meditation.com/power-chakra-guided-meditation.html>)
- (69) The most direct way to determine it is to examine the far distant behavior of the magnetic field generated by the black hole around itself.  
(<https://slideheaven.com/black-holes-in-our-universe.html>)
- (70) More recently oxytocin has been found to be released by the brain into itself ...  
(<https://books.google.com/books?isbn=9814488372>)
- (71) But soon also this will be sucked up by the earth into itself.  
(<https://gottfriedbennpoems.com/the-poems/>)
- (72) For that which is decidedly thick and earthy in nature, and has entirely escaped alteration in the liver, is drawn by the spleen into itself;  
(<https://faculty.humanities.uci.edu/bjbecker/PlaguesandPeople/week2j.html>)

Dropping the *by*-phrase in these examples yields unacceptable results. And it is perhaps impossible to find the relevant acceptable examples on the internet.

- (73) \*You find yourself rising and being pulled toward itself.
- (74) \*The most direct way to determine it is to examine the far distant behavior of the magnetic field generated around itself.
- (75) \*More recently oxytocin has been found to be released into itself ...
- (76) \*But soon also this will be sucked up into itself.
- (77) \*For that which is decidedly thick and earthy in nature, and has entirely escaped alteration in the liver, is drawn into itself;

The question is how to explain the unacceptability of (73)-(77). There are three cases to consider: (a) null generic ONE or YOU, (b) null existential UN, (c) null definite *pro*. Only the last

case is relevant. The null generic must be human, and the null existential has no phi-features. So the question is what rules out the following representation where pro is [3SG, inanimate]:

(78) \*The magnetic field generated pro<sub>1</sub> around itself<sub>1</sub>

I am not entirely convinced that this representation is ungrammatical. It may just be hard to interpret for a confluence of reasons. First, the UN interpretations are more accessible than the null definite pro interpretations (see the discussion following (65)). Second, the inanimate *itself* also has the inanimate subject as a possible antecedent, making the choice of the implicit argument as the antecedent difficult. For example, in (76) a possible antecedent of *itself* is the subject *this*. Third, in the examples given in (73-77) there is no antecedent for the implicit arguments.

If there is an overt antecedent is present, the examples become better (examples (79) and (80) are due to Gary Thoms, personal communication):

- (79) a. A black hole<sub>1</sub> can be measured if one examines the far distant behavior of the magnetic field generated pro<sub>1</sub> around itself<sub>1</sub>.  
b. A black hole<sub>1</sub> can be measured if one examines the far distant behavior of the magnetic field generated pro<sub>2</sub> around it<sub>1</sub>.

As these examples show, both a reflexive and non-reflexive pronoun are possible. But the difference may be correlated with different implicit arguments. In (79a), the black hole generates the magnetic field. In (79b), something else (not the black hole) generates the magnetic field. This difference is confirmed in the following example:

(80) A black hole<sub>1</sub> can be measured if one examines the far distant behavior of the magnetic field generated by these simulation programs around it<sub>1</sub>/\*itself<sub>1</sub>.

When there is an explicit *by*-phrase, the non-reflexive pronoun is acceptable, and the reflexive is worse (since the reflexive pronoun cannot be bound by *these simulation programs*).

## 2.7 Conclusion

In this chapter, I have shown that there are three possibilities for the phi-features of the implicit argument of the short passive. I summarize the results here:

- (81) a. Generic ONE/YOU:  
Phi-features: third/second person, singular, human, animate, generic  
b. Existential UN:  
Phi-features: none  
c. Definite pro:  
Phi-features: any non-empty combination of phi-features  
(other than [+generic])

In each case, I showed the existence of the implicit argument using a variety of different diagnostics (e.g., Principle A, Principle B, Helke Expressions). The trickiest case is (81b). Because the existential quantifier UN lacks phi-features, one cannot use the Binding Theory or Helke

expressions to diagnose its existence. However, such implicit arguments can still be controllers and they can be modified by a depictive secondary predicate (see chapter 3). Therefore, I claim that even in (81b) there is a syntactically present implicit argument.

Some unification of these three cases is possible. For example, (81a) is just a particular combination of phi-features, so it may fall under (81c). (81b) would also fall under (81c) if UN were not an existential quantifier expression, but rather a null pronoun whose variable denotation is existentially closed. I will return to this issue at the end of chapter 4.

A consequence of this work is that English has null *pro*. English is not a null subject language, in the sense of Italian, Spanish and other well-known languages, but there are certain contexts where *pro* can appear (e.g., the implicit argument of the passive). Another such case is the implicit dative argument described by Epstein 1984, Landau 2010 and Rizzi 1996: 550. In chapter 4, I will place these results in the larger context of a theory of implicit arguments.

### 3 Secondary Predicates and the Implicit Argument

#### 3.1 Introduction

The fundamental question that this monograph addresses is how external arguments are represented in passive constructions. Collins 2005a argues that the external argument in the passive is merged in the same way as in the active, namely in Spec vP (following the spirit of Chomsky 1957). Consider (1a,b):

- (1) a. John wrote the book.
- b. The book was written by John.

The proposal in Collins 2005a has the consequence that the DP *John* is merged into Spec vP in (1b) in the same way as in (1a). Another consequence of the proposal in Collins 2005a is that the short passive has a syntactically present, null external argument, analyzed there as arbitrary PRO (but see chapter 4 for a discussion of implicit arguments as PRO versus pro).

The structure of (2a) is then either (2b) or (2c) depending on the position of PRO. The precise position of the null implicit argument in the short passive is a tricky issue, since the implicit argument is covert, and is not relevant for the points made in this chapter.

- (2) a. The book was written.
- b. The book was [PRO written]
- c. The book was [written PRO]

One piece of evidence in Collins (2005: 101) for this analysis of short passives was based on the distribution of depictive secondary predicates:

- (3) At the commune, breakfast is usually eaten nude.

(3) shows that the implicit argument in a passive can license a depictive secondary predicate, just like the overt argument in an active can:

- (4) At the commune, the campers usually eat breakfast nude.

On the assumption that secondary predicates need to be licensed by a local c-commanding DP, it follows that in (3) there must be a syntactically present null argument. Surprisingly, a number of authors have claimed that depictive secondary predicates cannot modify the implicit argument of the short passive (including Williams 1985, Chomsky 1986, Pylkkänen 2008a, Landau 2010). Most of this chapter attempts to establish the following generalization:

- (5) Depictive secondary predicates can modify the implicit argument of the short passive.

In section 2, I present all the cases of depictive secondary predicates found in short passives that I can find in the syntax literature. I augment this list with naturally occurring examples found using Google. In section 3, I review the syntactic literature that rejects (5). In section 4, I present a formal analysis of depictive secondary predicates and show how to account for (5).

### 3.2 Secondary Depictive Predicates in the Short Passive

In this section, I present data concerning secondary depictive predicates in short passives. First, I review the examples given in the linguistics literature. Then I present some naturally occurring internet examples.

A number of examples were given in Roeper (1987: 297):

- (6) The game was played drunk/nude/sober/angry.

Baker (1988: 318) gives the following examples:

- (7) a. This song must not be sung drunk.  
b. Such petitions should not be presented kneeling.

Collins (2005: 101) adds the following example:

- (8) At the commune, breakfast is usually eaten nude.

Meltzer-Asscher (2012: 281) adds the following examples:

- (9) a. Traditionally, the koto was played seated on the floor.  
b. The hula is danced barefoot.

Stroik (1992: 132, fn. 7) adds the following examples:

- (10) a. The painting was painted blindfolded.  
b. I can tell that this letter was written in a good mood.  
c. This bank-job wasn't done alone.

Naturally occurring examples can easily be found on the internet using Google (see also Müller 2008 for some additional English examples found on the internet). First, I present a list of generic examples, then a list of episodic examples. All the following examples are completely acceptable for me (a native speaker of English).

The following examples are all generic, describing an activity that is usually done in a certain way (or should be done in a certain way):

- (11) If beach volleyball was played nude I would never leave my house.  
(<http://imgur.com/gallery/fPIhe>)

- (12) So here's looking at top 15 sports that should be played nude.  
(<http://www.thesportster.com/entertainment/top-15-sports-that-should-be-played-nude/>)

- (13) Originally the game was played naked in the burning sun,

- (<http://uncyclopedia.wikia.com/wiki/Australia>)
- (14) The school has settled on badminton as the best PE activity because it can be played fully clothed.  
(<http://islamversuseurope.blogspot.com/2010/08/>)
- (15) At the refugee camp, soccer was played barefoot,  
(<http://www.youthsoccerfun.com/2007/09/>)
- (16) Next the procession headed for the Chapel of the Burning Bush, which was entered barefoot: ...  
(<https://www.google.com/search?tbm=bks&q=pilgrims+to+jerusalem+in+the+middle+ages>)
- (17) Anyone like their coffee served topless?  
<http://www.theoryland.com/vbulletin/showthread.php?t=1184>
- (18) It really should be sung drunk, or not at all.  
(<https://twitter.com/stephenkb/status/781142776570339328>)
- (19) Our album is meant to be listened to stoned.  
(<http://www.nme.com/news/music/warpaint-61-1293400>)
- (20) Morning prayer was sung together at 6.55am before going to work.  
(<http://www.walsinghamcommunity.org/about-us/history/the-cornerstone-community>)
- (21) ...dinner was eaten together ...  
([http://www.huffingtonpost.com/entry/a-different-kind-of-dinnertime-grace\\_us\\_58f51c4fe4b04cae050dc9df](http://www.huffingtonpost.com/entry/a-different-kind-of-dinnertime-grace_us_58f51c4fe4b04cae050dc9df))
- (22) A duet can't be sung alone.  
(<http://archiveofourown.org/works/11051532/chapters/24638334>)
- (23) Completion of the hike must be done unassisted.  
(<http://www.margarita-adventures.com/faq/>)

Simpson (2005: 89) notes that depictive predicates in passives are often improved by modality and negation:

- (24) a. ?The song was sung drunk.  
b. This song can't be sung drunk.

Simpson proposes that in the case of (24b), there is a higher ModalP, and that the secondary predicate is adjoined to that ModalP as a 'conditional attribute.' Even if the syntactic position of the secondary predicate in (24b) is different from that in (24a), it is still able to pick out the implicit external argument of the passivized verb, which is the fact that needs to be accounted for.

In fact, Demonte (1986: 58) claims for Spanish that secondary predication of implicit arguments in the passive is acceptable in sentences with a modal and unacceptable without one. As the following examples show, no such constraint exists for English.

The following examples are all episodic.

- (25) At one place in one year, everything I saw was performed nude - a double bill of Baal and Woyzek, cabaret and improvisational dance.  
(<https://www.timeshighereducation.com/news/marks-for-the-nude-artists-and-beer-glass-hurler/163984.article>)
- (26) The field was crowded onto a relatively clear stretch of sand, the game was played barefoot, ...  
(<https://rosethompson.wordpress.com/tag/spirit-circles/>)
- (27) All of this very important work was done shirtless (natch), giving Zac plenty of opportunity to show off his newly acquired six-pack.  
([http://www.huffingtonpost.co.uk/entry/zac-efron-body-chest-shirtless-pictures-baywatch\\_uk\\_56dffffd2e4b05c52666e6558](http://www.huffingtonpost.co.uk/entry/zac-efron-body-chest-shirtless-pictures-baywatch_uk_56dffffd2e4b05c52666e6558))
- (28) Minaj admitted that the lapdance was completely choreographed, and was performed drunk.  
(<https://uinterview.com/news/nicki-minaj-twerks-and-gives-drake-a-lap-dance-in-anaconda-video/>)
- (29) and I'm pretty sure most of the part of Benjy in The Sound and the Fury was written drunk ...  
(<https://arstechnica.com/civis/viewtopic.php?f=23&t=710318>)
- (30) I mean most of the album was written drunk.  
(<http://www.genesis-news.com/c-Ray-Wilson-Interview-in-Heiligenhaus-2006-s119.html>)
- (31) ...but the whole staggering shebang sounds like it was done stoned ...  
(<http://homeofthegroove.blogspot.com/2006/11/>)
- (32) Not all of this was written sober, apologies.  
(<https://www.fanfiction.net/s/8858368/1/Check-The-Second-Box%29>)
- (33) The first verse was sung alone, with instrumental accompaniments, then gradually the choir joined in.  
([http://libera-historicaltimelinepart7.blogspot.com/2013\\_12\\_01\\_archive.html](http://libera-historicaltimelinepart7.blogspot.com/2013_12_01_archive.html))
- (34) It was done BLINDFOLDED, and this is one of the hardest Chopin etudes.  
(<https://www.facebook.com/LangLangPiano/posts/1606890532901147>)



- (35) The concert had some amazing moments, but by far the most touching was the final piece which was played blindfolded as a tribute to World Peace.  
(<http://www.milapfest.com/news/raams-samyo-diary-6/>)
- (36) All this was done unarmed!  
(<https://afrolegends.com/2009/12/03/the-forgotten-angel-of-rwanda-capt-mbaye-diagne/>)
- (37) Almost all the lifting was done unassisted.  
(<https://www.cdc.gov/niosh/nioshtic-2/00231105.html>)
- (38) This journey will be made unassisted and with no back up or support persons.  
(<https://www.linkedin.com/pulse/cycling-fundraising-making-difference-don-morris>)
- (39) ...so some of the work was done unprepared in the frigid (2 degree F windchill) weather without tripod or gloves.  
(<http://gopro.trendolizer.com/2016/03/toronto-cyyz-spotting-2015-a-glorious-return.html>)

For the purposes of this chapter, I have limited attention to adjectival secondary depictive predicates (including adjectival passives). I have yet to investigate examples with PPs (e.g., *in a good mood, in shorts*) and *-ing* participles (e.g., *singing, standing, sitting*) as secondary predicates.

A number of generalizations can be drawn about the data above. First, the presence of depictive predicates in the short passive seems to be a productive process. A wide range of adjectives are permitted, in both generic and episodic contexts. The adjectives found in the examples above are naturally grouped into various categories: state of clothing (*nude, naked, fully clothed, barefoot, topless shirtless*), state of intoxication (*drunk, stoned, sober*), number (*alone, together*) and adjectival passives (*unassisted, blindfolded, unarmed, unprepared*). The examples do not seem like idiomatic or fixed expressions.

I was unable to find a comprehensive list of adjectival secondary predicates for English. Most syntax papers that deal with the issue repeat the same handful of examples (e.g., *nude*). Therefore, it is not possible to know if there are systematic gaps between the kinds of secondary predicates that can modify the subject in active sentences and those that can modify the implicit argument in passive sentences. A corpus study of this issue would be quite useful.

Second, all the above examples also admit a *by*-phrase:

- (40) a. Breakfast is usually eaten nude by the campers.  
b. Breakfast is usually eaten by the campers nude.

Third, all of the examples are good in the active:

- (41) The campers usually eat breakfast nude.

Fourth, if a secondary depictive predicate is not possible in the active, then it will not be possible in the passive either. For example, as Simpson (2005: 93) notes: “Adjectives that can appear as depictives or resultatives are those that denote a transitory, bounded, temporally-restricted state, so-called stage-level predicates.” (42a) below is from Simpson and (42b) is the passive variant. As predicted, both are unacceptable:

- (42) a. He read the book \*intelligent/\*knowing/\*knowledgeable.  
 b. The book was read \*intelligent/\*knowing/\*knowledgeable.

In the next section, I address a number of examples from the literature where it has been claimed that a depictive predicate is possible in the active, but not the passive.

### 3.3 Some Counter-Proposals

The data in section 2 show that depictive secondary predicates can modify the implicit argument of a passive. In spite of this, there are numerous places in the syntax literature that deny this possibility.

Williams (1985: 308) considers the following example, attributed to Roeper:

- (43) The game was played nude.

Williams proposes that “...rather than saying that the adjective *nude* modifies the implicit agent of *played* we might say that it modifies the (overt) subject *game*, since one may call a game nude if it is played by nude people.”

Bhatt and Pancheva (2006: 585, footnote 11) responding to this argument note that “We find *The movie was watched nude*...acceptable. However, it seems a much greater stretch to refer to a movie that is watched nude as a nude movie.” Similarly, consider (29) above, saying that the part of Benjy is drunk seems nonsensical (see also Roeper 1993: 213 for a similar point).

Williams (1985: 309) also gives the following sentence:

- (44) \*The game was played mad at Bill

He explains that (44) is odd since one cannot say “The game was mad at Bill.” I find this sentence unacceptable as well, and I have been unable to find internet examples with *mad* used as a secondary predicate in short passives. Meltzer-Asscher (2012: 282) claims that the unacceptability of (44) is due to semantic or pragmatic factors: “Whether the players are mad at Bill has, in most contexts, no relevance to their playing the game.”

Alternatively, it may be that various classes of adjectives are not acceptable modifying the implicit argument of the passive for independent reasons. For example, it is difficult to find naturally occurring adjectives that assign an experiencer theta-role to their argument (*mad*, *angry*, *happy*). It may be that experiencer depictives such as *happy*, *angry*, *mad* are unacceptable in short passives for independent reasons.

Note, however, that Roeper (1987) uses *angry* in the example in (6). Furthermore, while (44) does seem to be degraded, Mica Clausen (personal communication, September 2021) has found acceptable examples involving experiencer adjectives. I find the sentences to be acceptable.

- (45) a. A game played angry isn’t as fun.  
 b. Apparently, revenge is a dish best served angry.  
 (torontosun.com/2014/09/28/matthew-stafford-stellar-for-detroit-lions)

The contrast between William's unacceptable example and Clausen's acceptable examples raises the general issue of when experiencer adjectives make good secondary predicates. I will not pursue that issue here.

Chomsky (1986:121) gives the following example (see also Jaeggli 1986: 614 who provides similar data based on *leave* and endorses Chomsky's conclusion):

- (46) a. They expected [PRO to leave the room angry]  
b. \*The room was left angry.  
c. \*The book sank angry.

He states: "The adjective phrase *angry* is predicated of PRO, not *they*, and only a syntactically present element can be its subject."

There are a few things to say about (46b). Passivizing this use of *leave* is marginal for some people (even without the secondary predicate):

- (47) a. ?The room was left by everybody.  
b. ?The room needs to be left early.

Second, in hearing (46b), one wonders who is angry. The interpretation that immediately comes to mind is that the room itself is somehow angry. So the interpretation would be parallel to the construction in (48a), which passivizes easily as shown in (48b):

- (48) a. I left the room messy.  
b. The room was left messy.

But even if the example is fixed to avoid these issues, it is still difficult to find examples on the internet of experiencer adjectives like *angry* modifying the implicit argument of the short passive. As noted above, an independent constraint might be at work.

In a footnote, Chomsky (1986:211) discusses Roeper's data:

- (49) "Roeper (1984) notes such examples as 'the game was played barefoot (nude),' which seems to violate the paradigm illustrated. Luigi Rizzi suggests that 'nude' may actually be adverbial, not adjectival, despite the morphology, as in some other languages."

Chomsky does not say what criteria are used here to classify *nude* as adverbial. There seem to be clear differences in meaning between secondary predicates and adverbs. Consider the following examples from Roeper (1993: 192):

- (50) a. The game was played drunk.  
b. The game was played drunkenly.

(50) means that at the time the game was played, the players were drunk. (50b) can imply (50a), but has a meaning related to the manner in which the game was played (e.g., screaming, yelling, exaggerated movements, lack of respect for the rules, slurred speech). Or to put it another way, (50b) does not entail that the players were drunk while playing the game (see also Aarts 1995: 90 and Schultze-Berndt and Himmelmann 2004: 61 for related discussion).

Another possibility for construing *nude* as an adverb in (49) is to suppose that it applies to an event: an event can be characterized as nude if the agent of the event is nude. This idea is different from William's proposal in that it relates the secondary predicate to the event described by the verb, and not to the derived subject. Also, even though *nude* would be an event predicate, it would not describe the manner of that event. Formally, this could be presented as follows. O is a type shifter, which takes the semantic value of an adjective and shifts it to a function which takes event arguments.

- (51) For all e, and for all  $P_{\langle e,t \rangle}$ , if e is in the domain of Agent, then  
 $O(P)(e)$  iff  $P(\text{Agent}(e))$

So in (49) above, the type shifter applies to *nude*, and the resulting predicate applies to the event described by the passive verb *played*. Such an analysis of secondary predicates makes no reference to a syntactically projected implicit argument.

The prediction of this account is that in general DPs describing events (event descriptions) should be possible as the arguments of adjectives describing the agent of the event. Generally, the examples are understandable, but marginal or ungrammatical:

- (52) a. \*The game/race/World Cup/competition was nude/naked.  
 b. \*The first verse/performance/song/race was alone/together.  
 c. \*The final piece/first movement/concert was blindfolded.

But note that such event descriptions can appear with predicates (like *take an hour*) that take events as arguments (similarly for other predicates such as *started at 6:00*, *involved many participants*, *took place last year*, etc.)

- (53) a. The game/race/World Cup/competition took one hour.  
 b. The first verse/performance/song/race took one hour.  
 c. The final piece/first movement/concert took one hour.

Under the theory in (51), it is unclear what would account for the clear difference in grammaticality between the sentences in (52) and the sentences in (53).

Lappin and Shlonsky (1993: 10) claim that for English (but not for German) "The passive morpheme is -TRP [cc. theta-role bearer], and so it cannot serve as the external argument of a circumstantial predicate." They give the following examples:

- (54) a. \*The concert was played formally dressed.  
 b. \*The lecture will be given naked.

While (54a) does seem a bit strained (as does the active variant), (54b) is acceptable, or at least not any worse than its active variant. I have presented acceptable internet examples involving *naked* above.

Pylkkänen (2008a: 22) characterizes the distribution of depictive secondary predicates as follows:

- (55) “This state can be predicated of either an internal or an external argument, although if the external argument is implicit, as in a passive, it cannot be modified by a depictive.”

She provides the following example:

- (56) \*This letter was written drunk.

For me, this sentence is a bit strained, but not ungrammatical. Gary Thoms says that for him it is completely fine. Richard Kayne suggests that (56) improves if one adds *it is obvious*, or *obviously*. I gave numerous internet examples with *drunk* above, all of which are grammatical. The internet examples provide a linguistic context which tends to ameliorate the use of the secondary predicate.

Citing Chomsky’s (1986) discussion, Landau (2010: 359) makes a distinction between two types of implicit arguments (see also Landau 2013: 72, 180, 185, 228). Then in (57) he stipulates that secondary predicates cannot modify weak implicit arguments:

- (57) a. Strong Implicit Arguments (SIA): PRO, pro  
b. Weak Implicit Arguments (WIA): Passive agent, implicit object

- (58) An implicit argument must be strong to license a secondary predicate.

Landau (2010:360) gives the following two sentences to illustrate his claims:

- (59) a. \*The issue was decided unassisted.  
b. \*The game was played shoeless.

First, these sentences are both a bit strained, but not unacceptable for me. Second, (59a) without a secondary predicate is not completely felicitous out of the blue (“The issue was decided.”). Third, an episodic sentence with *unassisted* is given in (37) above. Fourth, (59b) gets better if one uses *barefoot* instead of *shoeless*, see the example in (25).

Landau notes in a footnote: “See Roeper 1987:297-298 for a different view.” In addition to Roeper 1987, evidence contrary to (58) had already been presented by Baker (1988), Roeper (1993), Collins (2005), Bhatt and Pancheva (2006) and Müller (2008). See chapter 4 for more discussion of Landau (2010).

### 3.4 Analysis

So far, the following generalization has been established:

- (60) A depictive secondary predicate can modify the implicit argument of a passive.

In this section, I lay out the assumptions about depictive secondary predicates and the passive that will allow us to explain (60).

Based on binding, agreement and other data, Legendre 1997 convincingly argues that depictive secondary predicates are small clauses with a PRO subject (Dep is defined below in (64b)):

(61) They<sub>1</sub> played the game [Dep [PRO<sub>1</sub> nude]]

Exactly what the internal structure of [PRO nude] is, and what the label of the small clause is, are beyond the scope of this chapter (see Bowers 1997 for an analysis of resultative secondary predicates based on PredP). There is no evidence that depictive secondary predicates are non-obligatory control structures (e.g., long distance control, PROarb interpretations, etc.). Therefore, I assume that the relationship between *they* and PRO in (61) is obligatory control. This assumption entails three properties commonly ascribed to obligatory control (see Hornstein 1999 for an overview of properties of obligatory control, see Bowers 1993: 628 on the MDP and *promise*, see Landau (2013: section 5.1.3) for arguments against (61c)):

- (62) a. PRO<sub>1</sub> requires a controller DP<sub>1</sub>.  
 b. The controller DP<sub>1</sub> c-commands PRO<sub>1</sub>.  
 c. Minimal Distance Principle:  
 No DP<sub>2</sub> can intervene between the controller DP<sub>1</sub> and PRO<sub>1</sub>.

The properties are illustrated below:

- (63) a. \*It rained [PRO sad].  
 b. John's mother<sub>1</sub> wrote the book [PRO<sub>1</sub> drunk].  
 c. [John and Mary]<sub>1</sub> wrote the book [PRO<sub>1</sub> drunk].  
 d. John said that Bill<sub>1</sub> left [PRO<sub>1</sub> angry].

In (63a), PRO has no antecedent, so the sentence is unacceptable. In (63b), the only antecedent of PRO is *John's mother*, not *John*. Similarly, in (63c), both John and Mary have to be drunk, not just John. In (63d), if *angry* is in the embedded clause (when Bill left, somebody was angry), then its antecedent must be *Bill*, not *John*. In other words, (63d) cannot mean “John said Bill left while he (John) was angry.”

In addition to these assumptions, the temporal dependence of the secondary predicate on the main verb needs to be captured. Following Pylkkänen (2008a: 23), I assume that there is a head Dep that introduces the depictive (and that binds its situation variable). Pylkkänen notes that depictive predicates get essive case in Finnish, and assumes that it is assigned by the Dep head. The semantic values of the adjective and the Dep head are given below:

- (64) a.  $[[\text{nude}]] = \lambda x.\lambda s.\text{nude}(s,x)$   
 b.  $[[\text{Dep}]] = \lambda P.\lambda e.\exists s.P(s)$  and  $e^\circ s$

The raised circle symbol in (64b) is the temporal overlap relation, “employed to capture the fact that the depictive describes a state that holds during an event.” When the two morphemes are combined we get the following (suppose that PRO denotes John):

(65)  $[[\text{DEP}]] ([[ \text{PRO nude} ]]) = \lambda e.\exists s.[\text{nude}(s, \text{John}) \wedge e^\circ s]$

This expression is a predicate of events, such that the event overlaps with a state where John is nude. I also assume the following syntactic condition, motivated by the semantic value in

(65) (see Andrews 1982 and Roberts 1988 for syntactic tests indicating the position of depictive secondary predicates). In this definition, ‘verbal projection’ refers to any projection of V, v, ApplP, PartP or VoiceP.

(66) DepP is the sister of a verbal projection.

Given these assumptions, and assuming Collins’ (2005) theory of the passive, a partial representation of the sentence in (67) is given in (68):

(67) The game was played nude.

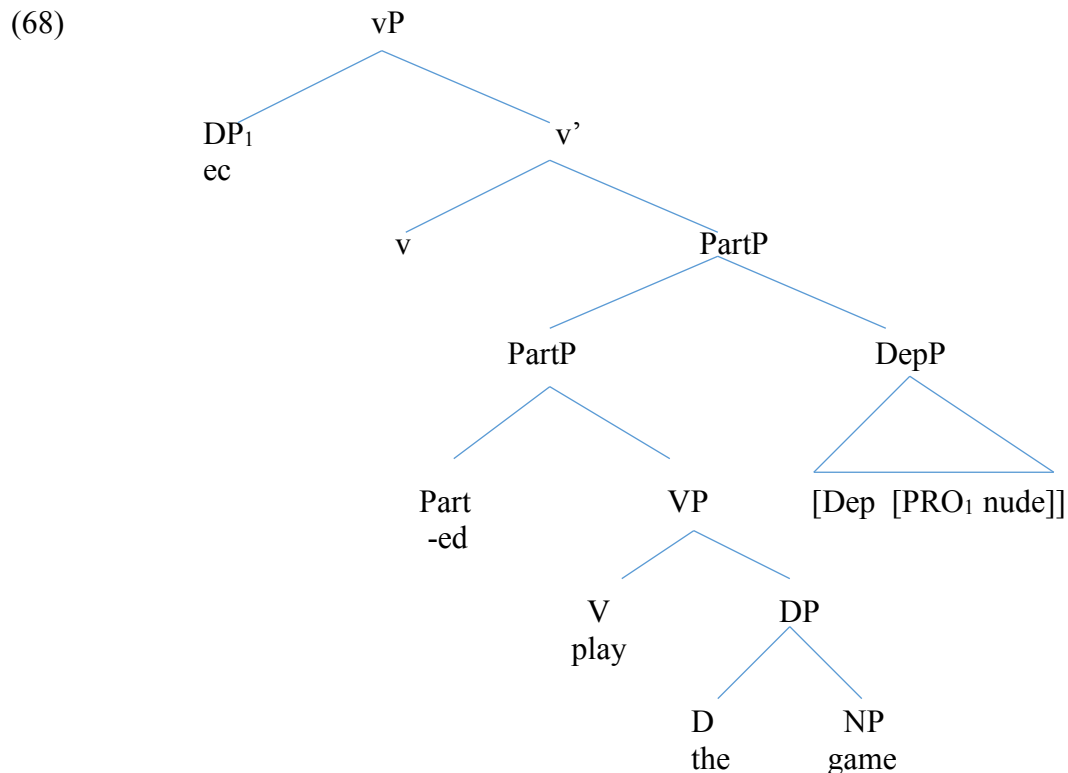

This structure is the underlying structure for the passive in the theory of Collins 2005a. As in Collins 2005a, I assume that the external argument (in this case the empty category ec) is projected in the same place in the passive as in the active, Spec vP. In chapter 4, I give a general theory of implicit arguments, where I analyze them as instances of pro.

Later operations move PartP to Spec VoiceP, and object DP to Spec TP (VoiceP and TP are not shown in (68), see Collins 2005a for details). I have represented the DepP as right adjoined to PartP, although other positions would have been possible (e.g., adjoined to VP). I represent the implicit argument as ec (‘empty category’) for now. I return to its exact identity in chapter 4.

Consider how all the requirements of the depictive predicate are satisfied. First, PRO has a c-commanding controller, satisfying (62a,b). Second, no other DP intervenes between the implicit argument and PRO, satisfying (62c). Third, DepP is a sister of PartP, satisfying (66). So all conditions on depictive predicates are satisfied, and the sentence is acceptable.

Other uses of adjectives should be distinguished from depictive secondary predicates:

- (69) a. Drunk, the world is beautiful.  
b. If one is/you are drunk, the world is beautiful.

(69a) could be paraphrased as in (69b). One difference between (69a) and the examples of depictive predicates is that it involves an extra semantic relation between the adjective and the rest of the clause (indicated by the translation as a conditional). I assume that (69a) involves ghosting in the sense of Collins and Postal 2012, and that the syntactic structure is similar to the sentence (69b), except the string <if one is/your are> has been deleted.

### 3.5 Cross-Linguistic Prediction

My theory of implicit arguments in the passive makes the following prediction:

- (70) In a language L, if predicate adjectives are inflected, and if the implicit argument A of a passive verb does not have phi-features, then A cannot be modified by an adjectival secondary predicate.

The explanation for this prediction is that if an adjective is necessarily inflected, it will not be able to get its phi-features from the implicit argument. The explanation of (70) is parallel to the explanation of Grinder's Chaining Constraint given in chapter 2, where an existential implicit argument cannot be the antecedent of a pronoun with phi-features.

Given the results of chapter 2, we may expect to find a language where the possibility of a secondary predicate in the short passive varies with the interpretation of the external argument. For generic and definite implicit arguments (having phi-features), the secondary predicate should be possible. For existential implicit arguments (lacking phi-features), the secondary predicate should be impossible. I leave it to further research to see if such predicted cases exist.

In fact, the implicit causee of the Icelandic causative construction looks like it might be an example of (70). Sigurðsson and Wood (2021) show that the implicit causee is syntactically projected, yet it fails to allow secondary predicates (pg. 611). But clearly, in Icelandic the secondary predicates are inflected for phi-features.

### 3.6 Conclusion

I have demonstrated the following generalization:

- (71) A depictive secondary predicate can modify the implicit argument of the short passive.

I then gave a theory of secondary predicates and passives that allowed one to account for this generalization. Briefly, secondary predicates are small clause structures (e.g., [PRO nude]) where the subject PRO is controlled by either the subject or the object. In the passive, the implicit argument is syntactically projected, and so is able to control PRO.



## 4 A Theory of Implicit Arguments

The purpose of this chapter is to provide a general theory of implicit arguments consistent with the results from chapters 2 and 3 on the implicit argument in the passive. In particular, in those chapters I showed that the implicit argument of the passive is a syntactically active argument (for secondary predicates, Principle A, Principle B and Helke expressions). From this, I concluded that it is syntactically projected. In this conclusion, I differ from researchers who have claimed that implicit arguments are not syntactically projected, including Williams (1987: 151): "... implicit arguments, which we will take to be simply unassigned theta-roles."

In this chapter, I will give a general theory of implicit arguments. First, I will explain which principles of UG force them to be projected syntactically. Then I will discuss formal licensing and interpretation. Lastly, I will give a survey of various kinds of implicit arguments in English and sketch how the general theory applies in each case.

The strength of the theory proposed here is that it will cover not only the passive, but other cases of implicit arguments in English as well, including evaluative predicates, dative controllers, middles and nominalizations. To the extent that the general theory of implicit arguments is successful, it provides additional support for the specific conclusions about implicit arguments in the passive of chapter 2 and 3.

### 4.1 Principles of UG and Implicit Arguments

What principles of UG force implicit arguments to be syntactically projected? The answer was presented briefly in the introduction, but I will give a more detailed version here in terms of the Theta-Criterion.

In an active sentence, the external argument is projected in Spec vP, as shown below:

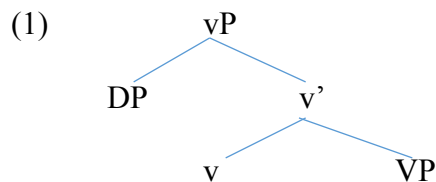

From this we know that Spec vP is theta-position. We know this because that position is occupied by an argument, and by the Theta-Criterion, arguments must occupy (be externally merged into) theta-positions.

Now, from this point of view consider the passive:

- (2)
- a. The book was written by John. (long passive)
  - b. The book was written. (short passive)

I assume that both forms of the passive (with or without the *by*-phrase) involve vP. After all, in (2a) the external argument is realized as a *by*-phrase, and in (2b) the external argument is detectable through entailments (e.g., *the book was written iff somebody wrote the book*). If there were no vP in (2a,b), then there would be no evidence for the presence of an external argument (e.g., no *by*-phrase and no entailments).

But if (2a) and (2b) involve vP, then an argument must fill Spec vP by the Theta-Criterion (because Spec vP is a theta-position). And therefore, both forms of the passive in (2) will involve a syntactically projected external argument. But this means that the implicit argument in (2b) will

be syntactically projected. As noted in chapter 1, a parallel argument can be given based on the Argument Criterion. We will return to *by*-phrases in chapters 5 and show that a similar argument holds for projecting them in Spec vP.

To clarify these issues, compare the analysis sketched above with the account of implicit arguments in Bruening 2013. Bruening gives the following structure for implicit arguments (modified slightly):

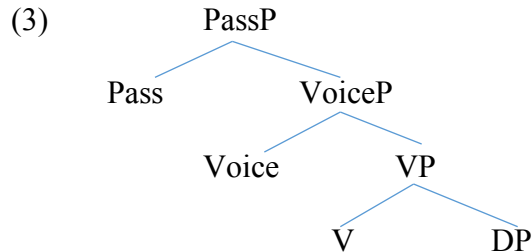

About this structure, he proposes (pg. 22) “... that passive is a head (Pass) that selects a projection of Voice that has not yet projected its external argument.” He elaborates on how the structure is interpreted as follows (pg. 23): “Although Pass syntactically selects an unsaturated Voice projection, it has the property of requiring that all of the arguments be saturated. This means that if the external argument of Voice has not been saturated, Pass will have to saturate it. It does this by existentially binding it. As stated earlier, all the evidence indicates that the external argument of a short passive is existentially quantified.”

Sigurðsson and Wood (2021: 584) who adopt a very similar system put it as follows: “In both the active and the passive structures, there is a Voice head that introduces agentive semantics. In actives, the agent is projected syntactically in Spec, VoiceP. In passives, the agent remains part of the semantics of Voice, but is not projected syntactically.” In fact, Sigurðsson and Wood (2021: 602) characterize it as the “standard view”: “...the standard view is that in languages like English (with periphrastic, participle-based passives), a Passive head attaches outside of a specifierless VoiceP.” Just like Bruening 2013 and Legate 2014, Sigurðsson and Wood 2021 fail to discuss the well-known binding theory data discussed in example (1), chapter 2.

The structure in (3) is a violation of the Theta-Criterion. In Bruening’s system, the external argument in an active is merged into Spec VoiceP, therefore Spec VoiceP is a theta-position. But in (3), Spec VoiceP is not projected. Therefore, the Theta-Criterion is incompatible with such representations.

Bruening’s generalization that the external argument of the short passive is existentially quantified is found fairly frequently in the literature (e.g., Williams 1987: 155). However, as shown in chapter 2, the claim is not correct. There are three different cases of implicit arguments in the passive: generic, existential and definite.

Putting aside this issue of interpretation, consider the semantic values that Bruening gives for Pass, PassP and Voice:

- (4)
- |    |           |   |  |
|----|-----------|---|--|
| a. | [[Voice]] | = | $\lambda f \lambda x \lambda e. f(e) \ \& \ \text{Initiator}(e,x)$                         |
| b. | [[Pass]]  | = | $\lambda f \lambda e. \exists x: f(e,x)$   |
| c. | [[PassP]] | = | $\lambda e. \exists x: \text{bribing}(e, \text{the senator}) \ \& \ \text{Initiator}(e,x)$ |

But notice that in (4c) the argument of *Initiator* has been satisfied, yet no external argument has been merged into the syntactic representation (rather, the argument of *Initiator* has been existentially closed). Syntactically, *Voice* is an argument introducing head, but it has not introduced an argument in (3), violating the Argument Criterion. This is another way to look at the incompatibility of Bruening's theory with the Merged-based theory of argument structure.

## 4.2 Licensing Implicit Arguments

Following Rizzi (1986: 518), a general theory of any kind of empty element will have to specify (a) how they are formally licensed, and (b) how they are interpreted. Rizzi puts it this way: "The minimal contribution that is to be expected from a theory of a null element is that it should specify (a) the conditions that formally license the null element (the conditions that allow it to occur in a given environment) and (b) the way in which the content of the null element (minimally, its phi-features) is determined or 'recovered', from the phonetically realized environment."

As explained above, on the Merge-based theory of argument structure, implicit arguments are syntactically projected elements. Therefore, in formulating a theory of implicit arguments, we need to address the following three questions:

- (5) a. What kind of empty element is an implicit argument?
- b. How is it licensed syntactically?
- c. What is its interpretation?

As for (5a), it is clear that implicit arguments are pronominal in nature. They can be understood indexically to be 1<sup>st</sup> or 2<sup>nd</sup> person pronouns, or they can have antecedents or they can be bound by a quantifier phrase. So, the choice is between small *pro* and big *PRO*. Prototypical cases of *PRO* are licensed in the specifier of an infinitival TP, unlike all the cases of implicit arguments discussed in this chapter. Furthermore, implicit arguments are never obligatorily controlled (unlike *PRO*). Therefore, I will analyze implicit arguments as *pro*, not *PRO* (see also Borer 2020 for relevant discussion of this issue).

In terms of possible interpretations, implicit arguments are similar to non-obligatory control (NOC) *PRO*. Hornstein (1999: 91) notes: "I have said very little about NOC *PRO*. I have silently assumed that it is identical to *pro*, the null pronominal found in various Romance and East Asian languages. This *pro* can be interpreted as a pronoun, either definite (hence similar to *he*, *they*, *she*, etc.) or indefinite (like English *one*). The latter underlies the so-called arbitrary reading. This requires assuming that *pro* can be licensed in English in NOC configurations." It may be that NOC *PRO* has the same analysis as the implicit arguments discussed in this chapter, and that a unified theory of both (that is, implicit arguments and NOC *PRO*) can be formulated. I will leave a more detailed comparison of implicit arguments and NOC *PRO* to future work.

What is the syntactic category of an implicit argument? Is it DP or NP or something else? I will assume that pronouns in general are DPs, and therefore implicit arguments are also DPs. For example, implicit arguments can take DP antecedents, bind reflexives and pronouns (which are DPs) and they can have definite interpretations (e.g., as indexicals), so it makes sense to analyze them as DPs.

As for licensing, I propose that implicit arguments are caseless. In minimalist syntax, being caseless comes down to lacking an uninterpretable structural Case feature [*uCase*] (for a precursor, see Epstein 1984: 503, fn. 8, who gives the filter \*[*pro* +Case], see also Borer 1998: 81, Borer 2020: 127).

(6) Implicit argument *pro* lacks a structural Case feature [uCase].

From the assumption in (6), I draw the following conclusions about implicit argument *pro* (not about the *pro* found in null subject languages, like Spanish or Italian):

- (7)
- a. Implicit arguments are covert.
  - b. Implicit arguments cannot be the goal for Agree.
  - c. Implicit arguments are always in-situ.
  - d. When the implicit argument alternates with an overt argument, the overt argument is a PP not a DP.

Overt DPs such as *John* or *the dog* all bear Case. In fact, the Case Filter was often stated with a proviso about phonetic overtness (see Chomsky 1995: 111 for discussion):

(8) Every phonetically realized NP must be assigned (abstract) Case.

Putting aside the issue of the distribution of PRO, and assuming (8) to be at least descriptively accurate, it follows that implicit arguments will never be overtly realized, because they do not have a structural Case feature.

If we assume that the goal for Agree needs an unchecked Case feature (the Activity Condition), then it follows that an implicit argument will never be the goal for Agree. Therefore, an implicit argument will never agree with T. In this way, implicit arguments are very different from the null subjects found in Italian and Spanish, which presumably do not lack a structural Case feature (and therefore can agree with T).

Furthermore, if we assume that A-movement requires Agree, then no A-movement will be possible. From this it follows that implicit arguments never appear in positions normally associated with the structural Cases: nominative, accusative or genitive. Rather, implicit arguments are forced to remain in-situ in their theta-position (externally-merged position). For example, in the passive, the implicit argument *pro* remains in Spec vP.

Could an implicit argument undergo A'-movement? I assume that this is impossible as well, perhaps because implicit arguments lack any kind of [uWH] feature that would allow them to be active for A'-movement (assuming an Activity Condition for A'-movement).

Some of the examples of implicit arguments surveyed below have the property that they alternate with PPs or KPs of various kinds (on KPs see chapter 5 and chapter 8 for definition and examples). For example, the implicit argument in the passive alternates with a *by*-phrase. The dative implicit argument alternates with a *to*-phrase. Since these PPs and KPs lack structural Case, it is not surprising to find them alternating with implicit argument *pro* which also lacks case.

A related theory would be that all implicit arguments are actually accompanied by a null preposition. For example, in the passive the implicit argument would be [by *pro*], where *by* is unpronounced. This theory (the covert PP theory) has the benefit of making implicit arguments completely parallel to overtly occurring arguments (*by*-phrases) in the passive and other constructions. It also does not need to assume that *pro* lacks a structural Case feature, since *pro* is the complement of *by* which can presumably check/value/assign structural Case. It also explains why implicit arguments appear in non-Case positions, because they are PPs which by assumption do not have a Case feature. However, the covert PP theory needs to explain how the preposition

comes to be null. The covert PP theory would also have to explain why implicit arguments do not have a wider distribution (e.g., Spec TP). While this theory is interesting, I will not pursue it here.

### 4.3 Interpreting Implicit Arguments

I assume that implicit arguments can be interpreted in the same way as any other pronoun. They may be understood indexically (referring to the speaker or hearer), they may be understood by virtue of an antecedent (either in the same sentence or in earlier sentences), and lastly, they may be understood as bound variables (bound by a quantifier expression, including operators like Gen). These interpretations are given here:

- (9) a. indexical interpretations
- b. coreferential with antecedent
- c. bound variable

The only type of interpretation that they lack seems to be the deictic pointing interpretation illustrated here:

- (10) HE is guilty! (pointing to the criminal)

The constraint can be illustrated with the passive:

- (11) a. John was seen. (pointing to the person who saw John)
- b. John was seen by HIM. (pointing to person who saw John)

While (11b) is acceptable in a pointing context, (11a) is not. This shows that implicit arguments cannot be used in a deictic pointing context.

This prohibition seems to be closely related to another property of implicit arguments:

- (12) Implicit arguments cannot be focused.

This property of implicit arguments follows from the assumption that focus requires an intonational contour realized on an overt DP. In other words, (12) is part of a larger generalization prohibiting covert arguments (including all kinds of pro and PRO) from being focused.

### 4.4 A Survey of Implicit Arguments in English

In this section, I discuss a range of constructions having implicit arguments and show how the assumptions given in (6-9) above apply. I will discuss evaluative adjectives, implicit datives, middles and nominalizations.

#### 4.4.1 Evaluative Adjectives

Evaluative adjectives are a prominent example of implicit arguments in English (see also Kimball 1971, Roeper 1987: 275, Bhatt and Pancheva 2017):

- (13) a. It is fun to play baseball.  
 b.  $(\forall x)$  if  $x$  plays baseball, it is fun for  $x$ .

As Epstein (1984) argues, the interpretation of (13a) is given in (13b). In other words, (13) involves an implicit argument *pro* of *fun* which controls the PRO subject of the embedded infinitival clause. Epstein proposes that *pro* is a universal quantifier: "...in the correct S-structure representation of the sentence, so-called PRO is controlled by (obligatorily controlled with) a base-generated quantificational empty category, namely, *pro*, occupying the governed complement NP position to the adjective." (pg. 502)

However, it is clear that evaluative predicates do not always involve universal quantification, as in the following example:

- (14) a. It was fun to promote myself at the conference.  
 b. It was fun  $pro_1$  [ $PRO_1$  to promote myself at the conference.]  
 c. John said it was fun to promote himself at the conference.  
 d.  $John_1$  said it was fun  $pro_1$  [ $PRO_1$  to promote himself at the conference.]  
 e. Every boy said it would be fun to promote himself.  
 f. [ $Every\ boy$ ] $_1$  said it would be fun  $pro_1$  [ $PRO_1$  to promote himself.]

I assume that *pro* in (14b) occupies a theta-position of the adjective phrase headed by *fun*, and so appears in-situ in a caseless position, alternating with a *for*-phrase. In (14b) in order to account for the 1SG form of the reflexive, we must analyze  $pro_1$  as an indexical referring to the speaker, and controlling PRO. In (14d), the implicit argument is bound by its antecedent *John*. In (14e), the implicit argument is bound by a quantifier phrase *every boy*, and receives a bound variable interpretation.

Therefore, I claim that in (13a) the implicit argument is just a pronoun (and not a universal quantifier), and it can be interpreted in the same way as other pronouns. When there is a universal reading, there is generic null operator in the sentence binding *pro* (just like the implicit argument of the passive can be bound by a null generic operator, see chapter 2). This approach seems more plausible than Epstein's approach where he assumes that "This element (*pro*) receives a universal quantifier interpretation in English only if it is antecedentless." (pg. 502, fn. 6) (See also Bhatt and Pancheva 2017: 24 who also invoke a generic operator for evaluative predicates).

It is unclear that evaluative predicates can have existential implicit arguments. Consider the following example:

- (15) Context: We are all going out to a bar, but we need to choose a designated driver for the way home. I announce to our group:  
 a. It is important to not drink tonight.  
 b. It is important for somebody to not drink to night.

The sentence in (15b) fits the context, but not (15a). Rather, (15a) uttered in the given context implies that the speaker or people in general should not drink tonight. In other words, (15a) does not seem to be existentially interpreted, rather it seems stronger.

The examples in (15) are in the present tense. But a similar lack of existential interpretation also arises for evaluative predicates in past tense sentences:

- (16) Context: Yesterday, I went to a baseball game. When a batter hit a home run in the fourth inning, a fan seated high up in the bleachers caught it. The next day, I report what happened as follows:
- a. Yesterday, it was great to catch that home run in the fourth inning.
  - b. Yesterday for somebody or the other, it was great to catch that home run in the fourth inning.

Although (16b) seems OK, (16a) does not seem to fit the context. Rather, (16a) uttered in the given context implies that the speaker or addressee caught the home run. (16a) does not seem to have an interpretation involving existential interpretation. To get the existential interpretation, an explicit phrase such as *somebody or the other* in (16b) needs to be added.

Similarly, one can follow existential implicit arguments in the passive with sluicing, leaving the *by*-phrase:

- (17) a. Yesterday, the recliner was used, but I don't know by whom.  
 b. The book was written last year, but I don't know by whom.

Such a continuation seems more difficult with evaluative adjectives:

- (18) a. \*Yesterday, it was great to catch that home run, but I don't know for whom.  
 b. \*It is important to not drink tonight, but I don't know for whom.

The generalization seems to be that the implicit argument of evaluative adjectives cannot be an existentially bound variable. If true, such facts suggest that the existential interpretation of an implicit argument is not possible across all constructions. Rather where it exists, it must be licensed by some particular morpheme which denotes an existential quantifier. No such morpheme is present with evaluative predicates. I return to the existential interpretation of implicit arguments in the passive below.

#### 4.4.2 Implicit Datives

A similar case occurs with the dative argument of verbs of saying (for discussion see Landau 2010, Rizzi 1986):

- (19) a. John signaled (to Mary) to leave.  
 b. John whispered (to Mary) to leave.  
 c. John said (to Mary) to leave.

In these cases, the implicit dative argument obligatorily controls PRO in the embedded infinitival clause. Consider the following example from Landau (2010: 367):

- (20) a. Mary hated it when we said to behave herself.  
 b. Mary<sub>1</sub> hated it when we said pro<sub>1</sub> [PRO<sub>1</sub> to behave herself.]

In (20b), *Mary* binds the implicit dative argument of *say*, which in turn controls PRO. This analysis makes the prediction that if the implicit argument of *say* is replaced by an overt argument, control by *Mary* should be blocked:

- (21) \*Mary<sub>1</sub> hated it when we said to Jim [PRO<sub>1</sub> to behave herself.]

About control by an implicit argument, I agree with Landau (2010: 357) who argues: “Although they participate in control relations, implicit arguments are standardly viewed as unprojected theta-roles, absent from the syntax. I challenge this view and argue that implicit arguments are syntactically represented.”

However, the theory developed in this chapter (and monograph) differs from that of Landau. In particular, Landau claims that there are two types of implicit arguments, Weak Implicit Arguments and Strong Implicit Arguments. Furthermore, he claims that the implicit argument in the passive is a WIA, and cannot be related to a secondary predicate. But chapter 3 shows the implicit argument in the passive can be related to a secondary predicate. So, I reject Landau’s classification of the implicit argument in the passive as a WIA, and correspondingly I reject his division between WIAs and SIAs. In my theory, there is just one type of implicit argument governed by the assumptions in (6-9).

The example in (20) shows that implicit dative arguments can be interpreted as definite. Can they also be existential and generic? I have not yet investigated this issue.

### 4.4.3 Middles

Stroik (1992, 1995, 1999, 2000, 2005, 2006) (see also Hoekstra and Roberts 1993, Postal 2010) has argued that the external argument in the middle is syntactically realized as PRO (but see Newman 2020 for a very rich empirical discussion that assumes that the external argument is not projected). The example below is from Stroik 1992: 134, (20):

- (22) a. Bureaucrats bribe easily.  
 b. [<sub>IP</sub> bureaucrats [<sub>I</sub> I [<sub>VP</sub> [<sub>VP</sub> bribe easily] PRO]]]

The arguments that Stroik gives for a syntactically present external argument involve Principle A of the binding theory and control of PRO in adjunct clauses. For example, consider the following example involving a reflexive pronoun contained in the subject (from Stroik 1992: 129):

- (23) Letters to oneself compose quickly.

According to Stroik the DP *letters to oneself* starts out in object position and moves to subject position. When in object position, the reflexive is bound by the implicit argument.

We can strengthen this argument by looking at Condition B effects:

- (24) a. Letters to yourself compose more quickly than letters to other people.  
 b. Letters to you compose more quickly than letters to other people.



My intuition about these examples is that *yourself* refers to the composer in (24a), but *you* does not refer to the composer in (24b), just exactly as would be predicted by Condition B if there were implicit external argument referring to the composer in both.

Stroik (1995: 168) also shows that control into adjunct clauses is possible with middles (see also Vinet 1987). Stroik analyzes these cases as control of PRO by the implicit argument of the middle:

- (25) a. Most physics books read poorly even after reading them several times.  
 b. Bureaucrats bribe easily after doing them a favor or two.

Stroik argues that the implicit argument is PRO, which occupies an adjunct position (adjoined to VP). I reject this part of Stroik’s analysis, and propose instead that the implicit argument is caseless pro which is merged into Spec vP, as with all external arguments. In other words, the external argument in the middle is projected exactly in the same way as in the active.

I do not take up the interpretation of the implicit argument in middles. For some discussion see Ackema and Schoorlemer (2017: 10): “A type I middle expresses a generic modal reading that can be roughly paraphrased as ‘anyone could V (Adv)’. For example, this meat cuts easily can be paraphrased as ‘anyone could cut this meat with ease’.” Their paraphrase of the middle suggests that middles are always interpreted generically. From our perspective, the issue is whether the implicit argument in middles has existential, generic and definite interpretations, just like the implicit argument in the passive. I have not yet investigated this issue.

#### 4.4.4 Nominalizations

The examples in (26) show that the implicit argument in nominalizations is syntactically active (for control, binding and secondary predicates) (see also Borer 2020 on the implicit argument of nominalizations).

- (26) a. The attempt to leave. (Williams 1987: 51)  
 b. Respect for oneself is important. (Williams 1987: 51)  
 c. Discussion of these issues stoned... (Safir 1987: 582)

On the theory we are developing, the representation of these examples is as follows:

- (27) a. The pro<sub>1</sub> attempt [PRO<sub>1</sub> to leave]  
 b. [pro<sub>1</sub> respect for oneself<sub>1</sub>] is important.  
 c. [pro<sub>1</sub> discussion of these issues [AdjP PRO<sub>1</sub> stoned]]

In (27a), the implicit argument controls PRO of the embedded infinitival clause. In (27b), the implicit argument binds the reflexive *oneself*. In (27c), the implicit argument is modified by a secondary predicate internal to the nominalization.

A famous contrast by Ross (1969: 195) gives further support for implicit arguments in nominalizations (see also Sichel 2009 on Condition C effects in nominalizations):

- (28) a. \*The knowledge that Fred<sub>1</sub> will be unpopular doesn’t bother him<sub>1</sub>.

- b. The knowledge that he<sub>1</sub> will be unpopular doesn't bother Fred<sub>1</sub>.
- (29) a. The possibility that Fred<sub>1</sub> will be unpopular doesn't bother him<sub>1</sub>.  
 b. The possibility that he<sub>1</sub> will be unpopular doesn't bother Fred<sub>1</sub>.

In (28a), the implicit argument of *knowledge* gives rise to Condition C effect. Since *possibility* does not have an implicit external argument, there is no similar Condition C effect in (29a). This is another illustration of the syntactic activity of implicit arguments. The representation of (28a) is as follows:

- (30) \*The pro<sub>1</sub> knowledge that Fred<sub>1</sub> will be unpopular doesn't bother him<sub>1</sub>.

Williams does not accept that implicit arguments are syntactically projected, but he does this at the cost of having to radically modify the binding theory: "I will explore here the possibility that the binding theory (plus control) applies not to NPs, but to the theta roles that are assigned to the NPs." (Williams 1987: 151). In this monograph, I adopt a standard version of the binding theory (not involving theta-roles).

The structure of (27a) is given in (31) (leaving out irrelevant details, see Bruening 2018 and Fu, Borer, Roeper 2001 for related proposals):

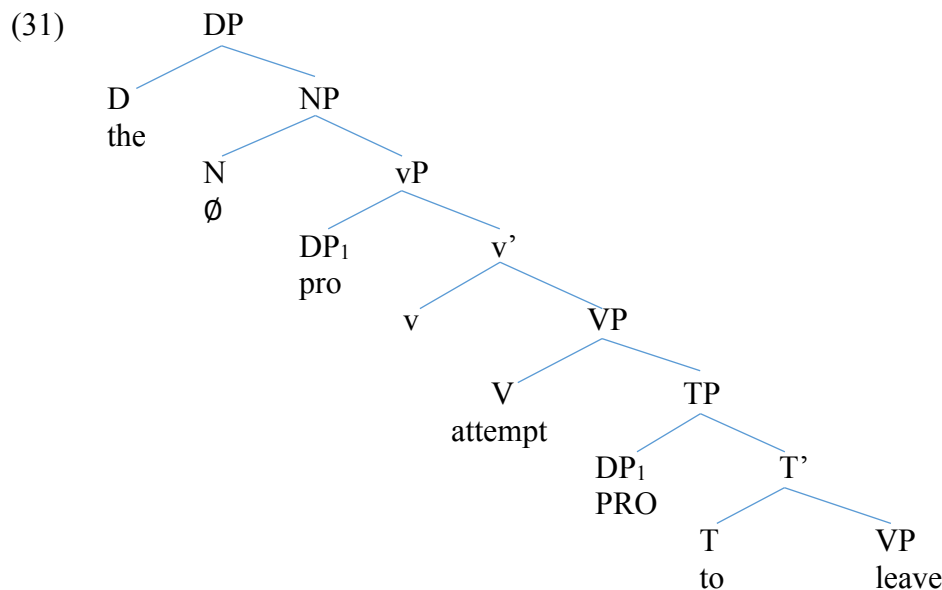

In (31), the implicit argument *pro* is in-situ in Spec vP, a caseless position (for example, it does not have genitive case).

Depending on the determiner and linguistic context, the implicit argument can be interpreted as definite (32a) or generic (32b,c) or existential (32d):

- (32) a. The constant promotion of himself at conferences hurt John's career.  
 b. Every player was involved in the promotion of himself at matches.  
 c. Any attempt to promote oneself is met with opposition.  
 d. The exclusion of girls from school entails the denial of education.

(Borer 2020: 117)

- e. There was an attempt to breach the fence this morning.  
(I don't know by whom).

In (32a), the antecedent of *himself* is the definite implicit argument of *promotion*. Similarly, in (32b), but in this case the implicit argument is bound by the quantifier phrase, and gets a bound variable interpretation. In (32c), the antecedent of the reflexive *oneself* is the generic pro (equivalent to generic *one*, see chapter 2 on the passive). The most natural interpretation of the implicit arguments in (32d) also seems to be generic *pro*. Lastly, the implicit argument in (32e) is existential, as shown clearly by the continuation.

On the existential and generic interpretation of implicit arguments in nominalizations, see Borer 2020. Borer 2020 argues that nominalizations lacking an overtly expressed external argument (Short Argument Structure Nominals) are actually nominalizations of verbal passives. If so, the existential interpretations of implicit arguments in nominalizations could have the same analysis as the existential interpretations arising in the passive.

Borer (2020: 116-117, 128) does not seem to recognize definite interpretations for the implicit argument in passives or nominalizations. But chapter 2 showed that definite interpretations are possible for the passive, and (32a) shows a definite interpretation for the implicit argument in a nominalization.

Much more work is needed on the syntactic mechanisms giving rise to these three interpretations (existential, definite and generic), the contexts that bring them out and the syntactic diagnostics (e.g., pronoun binding) that distinguish them.

#### 4.4.5 Complement Deletion

Consider the case of the verb *eat* (and related verbs, such as *bake*, *read*, etc.):

- (33) a. John ate.  
b. John ate something.  
c. John ate \*(it) raw.

It seems like (33a) entails (33b), in the sense that whenever (33a) is true, then so is (33b). Therefore, on the basis of this entailment, one may want to say that (33a) has an implicit theme argument. However, the ungrammaticality of (33c) without the pronoun casts doubt on that conclusion. If there were a syntactically present implicit argument in (33a), then it should be able to be syntactically related to the object-oriented secondary predicate (see chapter 3 where it is shown that the implicit argument in the passive can be related to a secondary predicate). But (33c) is ungrammatical without the pronoun, suggesting that there is no implicit argument in (33a).

I propose rather that (33a) has no implicit argument. And furthermore, the truth conditions of (33a,b) are as in (34a,b):

- (34) a.  $\llbracket(33a)\rrbracket$  =  $\exists e[\text{eat}(e) \wedge \text{Agent}(e,\text{John})]$   
b.  $\llbracket(33b)\rrbracket$  =  $\exists e\exists x[\text{eat}(e) \wedge \text{Agent}(e,\text{John}) \wedge \text{Theme}(e,x)]$

In other words, in (33a) there is neither a syntactic nor semantic implicit theme. But then how can one account for the entailment relation between (33a) and (33b)? I suggest that it is a

matter of real-world knowledge that when one eats, something needs to be eaten. But this information is not reflected in any way in the syntactic representation or in the semantic values of the intransitive verb. My approach is similar to that of Fodor and Fodor (1980: 760), who account for the entailment in terms of meaning postulates: "...the entailments of verbs are handled not by lexical rules which associate quantificational structure with syntactic form, but rather by rules of logical inference." (see also Williams 2015: 106 for relevant discussion).

The proposal that intransitive *eat* has the semantic value in (34a) supports an approach to internal arguments where they are introduced by argument introducing heads separate from the lexical verb (see Ramchand 2008 for a concrete proposal). In other words, in (33b) the internal argument *something* is introduced by an argument introducing verbal head  $v_{\text{THEME}}$  or  $v_{\text{IA}}$  (IA = internal argument). This head is distinct syntactically and semantically from the external argument little *v* and also from Appl. When  $v_{\text{IA}P}$  is present, there is a syntactically projected internal argument and the interpretation is (34b). When  $v_{\text{IA}P}$  is absent, there is no syntactically projected internal argument and the interpretation is (34a). Since the focus of the monograph is external arguments, I do not pursue this line of analysis here.

Similar remarks hold for Rizzi's (1986: 503) discussion of the following English cases:

- (35) a. This leads people to the following conclusion.  
 b. This leads to the following conclusion.  
 c. This leads people [PRO to conclude what follows].  
 d. \*This leads [PRO to conclude what follows].

The example in (35d) is important in that it shows that obligatory control is syntactic. Even if there were a pragmatic inference from (35b) to the proposition that somebody was led to a certain conclusion, such a pragmatic inference is not sufficient to license control of PRO in (35d). In other words, whenever there is obligatory control, we can be certain that the antecedent in that obligatory control relation is a syntactically projected DP.

This conclusion raises a number of questions. First, why are sentences parallel to (35d) acceptable in Italian (see Rizzi 1986: 503, (8)). I assume that Italian has a null object form of the pronoun *one* that English lacks. It is unclear to me what accounts for this difference. Second, why couldn't *people* in (35c) be replaced by a syntactically active implicit argument, making (35d) acceptable? In other words, just like the implicit argument in the passive can control PRO, the implicit argument in (35d) would control PRO. The representation would be:

- (36) \*This leads  $pro_1$  [PRO<sub>1</sub> to conclude what follows].

But note that the object of *lead* is a case position. It alternates with an accusative marked DP pronoun, for example. Therefore, *pro* in (36) does not qualify as an implicit argument according to the assumption in (6).

#### 4.4.6 Revisiting the Passive

Consider again the passive, discussed in chapters 2 and 3:

- (37) That book was written in 1784.

Out of the blue, the most obvious interpretation of (37) is that the external argument is existentially quantified:

(38) Somebody wrote that book in 1784.

The question is how the existential interpretation arises in the theory of implicit arguments laid out in the preceding sections. Overt pronouns do not generally have an existential interpretation, so how does the implicit argument come to be interpreted existentially.

In line with the Merge-based approach to argument structure, I assume that the existential interpretation is not the result of some purely semantic rule, rather:

(39) On the existential interpretation of the passive, there is a morpheme in the syntactic representation that denotes an existential quantifier.

Give this general background assumption, we can divide the possibilities for capturing the existential interpretation into the following possibilities:

- (40) (a) The external argument is not projected.  
 (Bruening 2013, Legate 2014, Pylkkänen 2008a)  
 (b) The external argument is projected as a null pronoun.  
 (Collins 2005a, Borer 2020)  
 (c) The external argument is projected as a null quantifier expression.  
 (called UN in chapter 2).

This monograph argues extensively against (40a). See the beginning of this chapter for a critical discussion of Bruening 2013, for example. So here I will just consider (40b) and (40c). Consider first (40b), which is consistent with the general theory of implicit arguments that treats them as caseless *pro*.

There are two possibilities consistent with the assumptions in (39) and (40b). First, there could be a null operator (similar to the generic operator *Gen* in chapter 2 following Moltmann 2006) that unselectively binds the implicit argument *pro*. Second, there could be a head (e.g., similar to Bruening’s *Pass*, Pylkkänen’s *Voice<sub>PASS</sub>*, see also Borer 2020: 127), that unselectively binds the syntactically projected implicit argument *pro*. I will discuss each of these alternatives in turn.

Consider the possibility that there is an existential operator *OP* unselectively binding the implicit argument *pro*. The structure is given below:

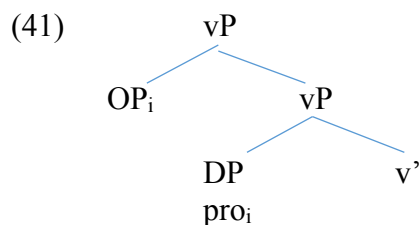

The model for this kind of analysis could be Diesing’s 1992:6 analysis of indefinites (see also Zimmerman 2007): “Here the variable introduced by the indefinite is bound by an implicit

existential quantifier that ‘existentially’ closes off the nuclear scope, preventing the occurrence of unbound variables.” Crucially, Diesing 1992 did not link such an existential interpretation to the passive, but rather to the indefinite arguments dominated by VP: “...existential closure applies to nuclear scopes (or VPs) only, as implied by the tree-splitting algorithm.” (pg. 57) For an application of existential closure in Diesing’s sense to the implicit argument in the passive, see Murphy 2015.

One question this approach raises is what determines the syntactic distribution of the existential OP? Can it adjoin to any maximal projection? A related question is whether existential interpretations are available for implicit arguments in general (no matter what construction they appear in). If the existential interpretation were freely available, tied only to the presence of OP adjoined to XP, it is not clear why an existential interpretation is not available for evaluative predicates (as discussed earlier in this chapter). Another question is whether it is ever possible for a single existential operator to unselectively bind two implicit arguments at the same time.

Consider now the possibility that there is a functional head introducing the existential quantifier. One possibility to consider is that Voice (in the sense of Collins 2005a) itself introduces the existential interpretation. So in the structure [<sub>VoiceP</sub> Voice [<sub>vP</sub> pro v’ ]], Voice would be an unselective existential quantifier binding the implicit argument pro. But not all passives involve an existential interpretation. For example, when the *by*-phrase is present, there is no existential interpretation. Also, as shown in chapter 2, sometimes passives are interpreted with a generic or definite external argument. So there would have to be two Voice heads, one that unselectively binds a variable, and the other that does not. Alternatively, there would have to be a Voice head with an optional existential quantifier feature. This analysis raises the question of which functional heads could have an optional existential quantifier feature. It also involves an instance of syntactic bundling of two very different syntactic functions onto one syntactic head (see Kayne 2005: 2012 on the Principle of Decompositionality).

An alternative is to optionally generate a functional projection between Voice (in the sense of Collins 2005a) and vP that existentially closes the implicit argument of the passive. The structure would be as follows:

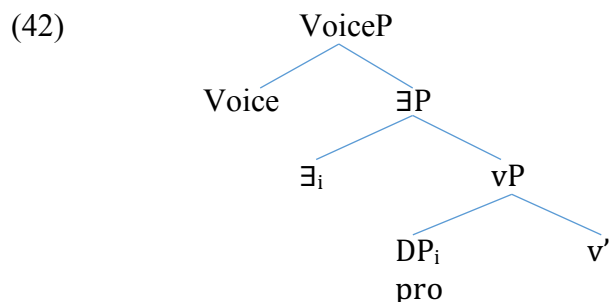

The two issues that need to be addressed in such an analysis are: (a) What is the syntactic distribution of ∃P? Is it limited to the passive, or is it more widely available? Can it appear with any vP (as the discussion in Diesing 1992 seems to suggest). (b) Why is the existential quantifier the head of a clausal functional projection in (42), whereas it seems to head a QP in other uses (e.g., *some boys*)?

In chapter 2, the existential interpretation of the implicit argument in the passive is introduced by a null existential quantifier UN. The problem with this approach is that if UN is available for the passive, why is it not available for all the implicit argument constructions? I

pointed out above that evaluative adjective constructions are not interpreted existentially. If UN is possible, then why isn't the following representation possible:

- (43) It was fun UN<sub>1</sub> [PRO<sub>1</sub> to swim]  
Intended: "For somebody, it was fun to swim."

I propose that the existential reading of the passive is given by UN (a kind of null argument), but that UN itself is licensed by Voice. In other words, existential UN as an implicit argument is only found in the passive. For concreteness, UN has an [uVoice] feature, and raises and adjoins as a clitic to Voice to check the feature.

In summary, I have proposed four possible sources for the existential interpretation of the implicit argument in the passive.

- (44) a. Existential operator binding pro.  
b. Existential feature of Voice binding pro.  
c. Existential functional head binding pro.  
d. Existential implicit argument (UN) in Spec vP.

I assume that any of these four approaches are consistent with the general Merge-based framework I am sketching in this monograph (in that the existential interpretation is being introduced through external Merge of a morpheme denoting an existential quantifier). I leave it to future work to articulate the different predictions of these four possibilities. For example, there is the issue of how these various possibilities dovetail with theories of narrowest scope indefinites (bare plurals) and wide scope indefinites (see Heim 2011 for discussion of these topics). In the remainder of this monograph, I will adhere to (44d).

## 4.5 The Wedge

In proposing a general theory of implicit arguments, it could be argued that I am engaging in a non-sequitur. Even though the implicit argument in the English passive is syntactically projected (shown by the diagnostics in chapters 2 and 3), perhaps there are many other kinds of implicit arguments that are not syntactically projected. Perhaps there are some languages different from English where implicit arguments are not projected syntactically at all (even in passives and nominalizations, for which the evidence in English is very strong). On this view, one would need to look at constructions and languages on a case by case basis, and apply the tests available in the language. However, I want to take the strongest possible position (and therefore, the most easily falsifiable) and claim that all implicit arguments in all languages are syntactically projected.

In chapters 2 and 3, I argued that the implicit argument in the passive is syntactically projected on the basis of reflexives, Helke expression and secondary predicates. I will call this argument the wedge, because of its far-ranging consequences. The metaphor is that the generalizations about the English passive help to pry open a much larger generalization concerning implicit arguments cross-linguistically. I will now argue that all implicit arguments (across different constructions and different languages) are syntactically projected, whether or not any syntactic data actually supports that conclusion for a particular construction in a particular language.

At least in the case of the passive, it is far from clear that a child would have adequate access to the relevant data to actually learn that the implicit arguments are syntactically projected. Consider the well-known sentences discussed in chapter 2, repeated below:

- (41) a. Such privileges should be kept to oneself.  
(Baker, Johnson and Roberts 1989: 228, Roberts 1987: 162))  
b. Damaging testimony is always given about oneself in secret trials.  
(Roberts 1987: 162)

Exactly when would a child have access to this kind of data (involving a passive, a verb with a PP argument and the reflexive *oneself*), which seem rather complex sentence types? And if somehow the child did hear these kinds of sentences, would they understand them in context? And if they understood them in context, would they parse them correctly? And if they parsed the correctly, would they thereby draw the conclusion that the implicit argument is syntactically projected (or would they chalk the data up to exempt anaphora)? Although I have not done a corpus study, my suspicion is that the relevant data is vanishingly rare, especially in child-directed speech.

Rather, it is more plausible to assume that the child does not have to learn anything at all about implicit arguments. Suppose the child hears an example of the passive, even a very simple one such as (42):

- (42) That book was written very quickly.

If the child understands that the external argument is involved (that is, somebody did the writing very quickly), then given the AC/TC from chapter 1, they automatically assume that there is a syntactically projected implicit argument. So instead of being guided by empirical phenomena related to whether implicit arguments are syntactically projected or not, the child is guided by principles of UG.

In other words, data from implicit arguments support a classical poverty of stimulus argument for a principle of UG. Principle P (implicit arguments in the passive are syntactically projected) is not learnable from the primary linguistic data, therefore P must be a principle of UG or must follow from principles of UG (in this case the AC/TC).

But if the AC/TC holds, it entails that implicit arguments are syntactically projected. Therefore, it follows that across different kinds of constructions (e.g., evaluative adjectives, implicit datives, middles, nominalizations), and different languages (e.g., Italian, Ewe), implicit arguments are always syntactically projected.

Here is the argument laid out step-by-step:

- (43) a. Reflexives, Helke expressions and secondary predicates show that the implicit argument in the English passive is syntactically projected.  
b. The child does not have access to the relevant data.  
c. Therefore, there is a principle of UG (AC/TC) forcing implicit arguments to project syntactically in the passive.  
d. Principles of UG are not specific to the passive, or any other construction (because particular constructions are not part of UG).  
e. Principles of UG hold for all languages.



- f. Therefore, implicit arguments are syntactically projected in a wide variety of constructions across all languages.

This argument goes from particular facts about the English passive to a general cross-linguistic theory of implicit arguments.

#### 4.6 Conclusion

In this chapter, I presented a general theory of implicit arguments: an implicit argument is *pro* without a [uCase] feature. As such, it cannot appear in any position associated with Case assignment (Spec of finite TP, Spec DP). As a pronoun, it can be interpreted as (a) indexical, (b) coreferential with an antecedent, or as (b) a bound variable. Although I have only discussed English in this chapter, I put forth the strongest possible hypothesis that such an analysis of implicit arguments holds as part of UG, hence for all human languages. If this is true, then all languages have null *pro*. This means that the terms “Null Subject Language” and “Pro-Drop Parameter” (e.g., Italian, Spanish) need to be taken as applying specifically to languages that have *pro* bearing an uninterpretable Case feature.

In this chapter, I have not discussed intransitive verbs with definite implicit arguments (e.g., *notice*, *join in*, *approve*, *watch*, *apply*). Fodor and Fodor (1980) describe this class of verbs as follows: “The sentence *John ate* (or, at least, *John is eating*) can be used to initiate a discourse, but the sentence *John noticed* cannot; it needs some suitable prior context, such as *Bill was nervously biting his nails* or *The audience was quietly creeping out of the emergency exit*. A natural way to describe this would be to say that *John noticed* entails not *John noticed something* but *John noticed it*; that is, that the entailed object of a notice-class verb is definite.” Fillmore (1986) calls these cases *definite null complements*.

It is unclear how this class of verbs fits into the theory outlined in this chapter. Much further work is needed. For example, does the possibility of having a definite null complement need to be lexically specified? What kinds of thematic-roles can such null complements have? What kinds of syntactic categories can be null complements (DPs, PPs, CPs, etc.)? How does their interpretation differ from that of an overt definite pronoun? Do they pass any diagnostics for being syntactically active? For further discussion, see Fillmore (1986), Fodor and Fodor (1980), Williams (2015: chapter 5 for a detailed discussion of possible analyses).

## 5 *by*-Phrases

### 5.1 Introduction

Some recent works on the passive have claimed that the *by*-phrase is an adjunct. A few quotes illustrate this claim. Consider first the following quote by Legate (2014: 2):

- (1) “The ‘by’-phrase in the passive is an adjunct in which ‘by’ assigns an initiator T-role to its DP complement, and this initiator is tied semantically to the initiator T-role introduced by Voice.”

Although most of Legate’s book is about Acehnese, it is clear that she maintains an adjunct analysis for English *by*-phrases as well (see page 82).

Bruening (2013: 24) maintains a similar position (see also Hallman 2015: 396 for an adjunct analysis of *by*-phrases similar to that of Bruening):

- (2) “As detailed earlier, *by* phrases, instrumentals, and comitatives all require the category Voice. I take this to mean that, although they are adjuncts, they strictly select the syntactic category of the phrase they adjoin to.”

These conclusions are familiar from the Principles and Parameters literature that also largely analyzes the *by*-phrase in the passive as an adjunct (see for example, Carnie 2013: 334). For a historical overview of analyses of the *by*-phrase in generative grammar, see Collins 2018.

The novelty of the positions in (1) and (2) is that they are tied to an explicit treatment of the semantics of *by* (see Bruening 2013: 25, and see Legate 2014: 41 for a related proposal):

- (3) a.  $[[by]] = \lambda x \lambda f_{\langle e, st \rangle} \lambda e. f(e, x)$   
b.  $[[by\ the\ lobbyist]] = \lambda f_{\langle e, st \rangle} \lambda e. f(e, the\ lobbyist)$

In (3b), the phrase *by the lobbyist* denotes a function which takes the denotation of a Voice-phrase as an argument (so *by the lobbyist* denotes a function of a function).

This chapter will argue against the assumption made by Bruening and Legate that the *by*-phrase is an adjunct based on evidence from the binding theory. Angelopoulos, Collins and Terzi (2020) extend the arguments in various ways, and show how the same results hold in Greek (on the status of adjuncts in syntactic theory, see Sportiche 2017b).

### 5.2 Theta-Criterion

In this section, I will show that Bruening’s analysis is inconsistent with the Merge-based theory. The question is which principles of UG rule out such an analysis. I suggest that the relevant principle is the Argument Criterion/Theta-Criterion (see chapter 1). The Theta-Criterion is repeated below:

- (4) Theta-Criterion (Chomsky 1986: 97)  
Each argument  $\alpha$  appears in a chain containing a unique visible theta-position P, and each theta-position P is visible in a chain containing a unique argument  $\alpha$ .

In light of the Theta-Criterion, consider Bruening's structures. According to Bruening, the external argument in the active is projected in Spec VoiceP, as follows (based on Bruening 2013: 21):

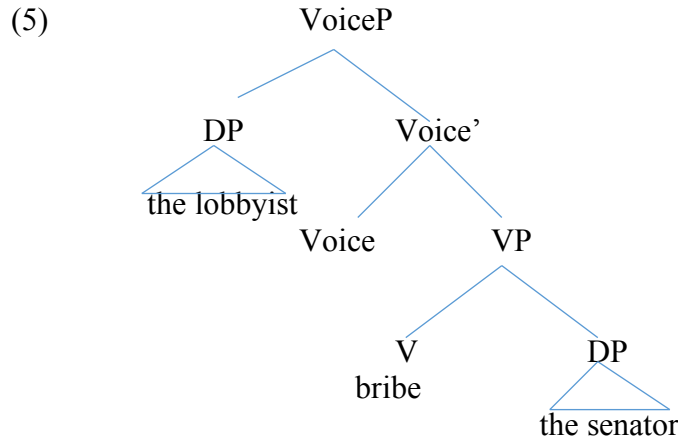

Bruening argues that in the passive when there is a *by*-phrase, it is adjoined to VoiceP (pg. 24):

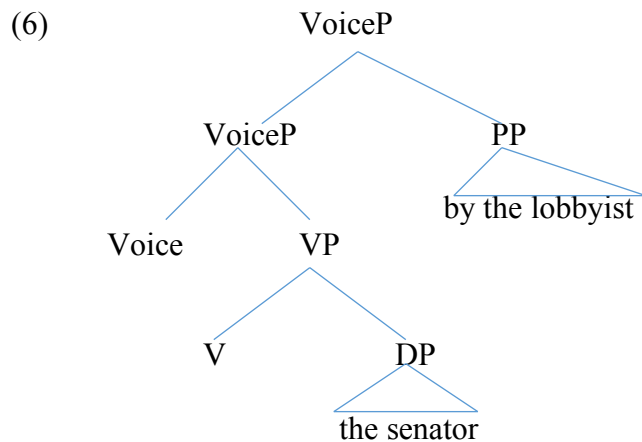

(5) shows that Spec VoiceP is a theta-position in the active, since it is filled by an argument. Therefore, as a Theta-Position, Spec VoiceP needs to be filled in the passive as well, but as shown in (6), Spec VoiceP is not filled in the passive. Therefore, (6) violates the Theta-Criterion.

Consider now the Argument Criterion. (5) shows that Voice is an argument introducing head in the active. Therefore, it must introduce an argument in the passive as well. But no argument is introduced in (6). Recall on Bruening's account, the PP *by the lobbyist* is not an argument, but rather a predicate taking a function as an argument.

Another way to see the inconsistency between the Merge-based theory and the adjunct theory is in terms of the semantic value of *by*. For Bruening, the external argument is satisfied when the *by*-phrase combines with VoiceP, and applies the semantic value of VoiceP to *the lobbyist*. But in the Merge-based theory, the only way to build argument structure is by merging arguments together with argument introducing heads.

### 5.3 Adjuncts versus *by*-Phrases and the Binding Theory

In this section, I will give evidence from binding which supports the theoretical conclusion in section 1. Collins (2005: 111) gives the following examples of a reflexive being bound by the external argument in a passive:

- (7) a. The magazines were sent by Mary to herself.
- b. Testimony was given by the suspect about himself.

Legate (2014: 71) gives similar data for Indonesian, but she does not discuss its significance.

Building on this data, consider the following contrasts between *by*-phrases and adjuncts with respect to the binding of reciprocals. In the following sentences, the relevant interpretation is where *each other* takes *the children* as an antecedent.

- (8) a. The packages were sent by the children to each other.
  - b. \*The packages were sent for the children to each other.
  - c. \*The packages were sent on behalf of the children to each other.
  - d. \*The packages were sent because of the children to each other.
- (9) a. The pictures were painted by the children for each other.
  - b. \*The pictures were painted with the children for each other.
  - c. \*The pictures were painted near the children for each other.
  - d. \*The pictures were painted in spite of the children for each other.

Reflexives give rise to a similar paradigm:

- (10) a. The packages were sent by the children to themselves.
  - b. \*The packages were sent for the children to themselves.
  - c. \*The packages were sent on behalf of the children to themselves.
  - d. \*The packages were sent because of the children to themselves
- (11) a. The pictures were painted by the children for themselves.
  - b. \*The pictures were painted with the children for themselves.
  - c. \*The pictures were painted near the children for themselves.
  - d. \*The pictures were painted in spite of the children for themselves.

The generalization is the following:

- (12) a. The DP of the *by*-phrase in a passive can bind a following clause-mate anaphor.
- b. The DP of an adjunct PP in a passive cannot bind a following clause-mate anaphor.

The generalization (12a) already appears in Collins (2005: 111). The generalization in (12) may be part of a larger generalization formulated by Postal (2010: 274) that “If A is a reflexive

arc, then A has a Term neighbor that arc-antecedes A.” This can be translated roughly into lingua franca as follows (thanks to Paul Postal for the translation): “If X is a reflexive form, then there is an antecedent Y which is a clause mate of X and which is either a subject, direct object or indirect object.” For the purposes of this exposition, we will focus on the generalization in (12).

The data in (8-11) clearly distinguishes adjuncts (from which binding is never allowed) and *by*-phrases (from which binding of anaphors is allowed). Such a distinction argues against the claims in section 1 that *by*-phrases are adjuncts. Since if *by*-phrases were adjuncts, they should behave like adjuncts with respect to the binding data.

The following data are controls, showing that the problem with the examples above is the binding of a reflexive or a reciprocal. A pronominal possessor does not give rise to the same contrasts.

- (13) a. The packages were sent by the children to their mothers.  
b. The packages were sent for the children to their mothers.  
c. The packages were sent on behalf of the children to their mothers.  
d. The packages were sent because of the children to their mothers.
- (14) a. The pictures were painted by the children for their mothers.  
b. The pictures were painted with the children for their mothers.  
c. The pictures were painted near the children for their mothers.  
d. The pictures were painted in spite of the children for their mothers.

#### 5.4 Inanimate *by*-Phrases

Angelopoulos, Collins and Terzi (2020) show that the above paradigm extends to inanimate *by*-phrases. All the data in this section are from their paper.

- (15) a. The magnet<sub>1</sub> attracted the metallic objects towards itself<sub>1</sub>.  
b. The metallic objects were attracted by the magnet<sub>1</sub> towards itself<sub>1</sub>.
- (16) a. The black hole<sub>1</sub> drew the planets into itself<sub>1</sub>.  
b. The planets were drawn by the black hole<sub>1</sub> into itself<sub>1</sub>.
- (17) a. The tornado<sub>1</sub> sucked the houses up into itself<sub>1</sub>.  
b. The houses were sucked up by the tornado<sub>1</sub> into itself<sub>1</sub>.
- (18) a. The magnet<sub>1</sub> repelled the pieces of metal away from itself<sub>1</sub>.  
b. The pieces of metal were repelled by the magnet<sub>1</sub> away from itself<sub>1</sub>.

Such examples are also easy to find on the internet:

- (19) You find yourself rising and being pulled by the sun<sub>1</sub> toward itself<sub>1</sub>.
- (20) The most direct way to determine it is to examine the far distant behavior of the magnetic field generated by the black hole<sub>1</sub> around itself<sub>1</sub>.

- (21) which is thus an external demagnetising field applied by the magnet<sub>1</sub> to itself<sub>1</sub>...
- (22) More recently oxytocin has been found to be released by the brain<sub>1</sub> into itself<sub>1</sub> during sexual intercourse,
- (23) But soon also this will be sucked up by the earth<sub>1</sub> into itself<sub>1</sub>.
- (24) The investment made by the country<sub>1</sub> into itself<sub>1</sub> has paid back hundreds of times over, and will keep paying back.
- (25) The objects presenting themselves, in so far as they are sources of pleasure, are absorbed by the ego<sub>1</sub> into itself<sub>1</sub>,
- (26) For that which is decidedly thick and earthy in nature, and has entirely escaped alteration in the liver, is drawn by the spleen<sub>1</sub> into itself<sub>1</sub>;
- (27) These are income benefit or resources earned or generated by the organization<sub>1</sub> from itself<sub>1</sub>.

As pointed out by Angelopoulos et. al. (2020) the data involving inanimate *by*-phrases provides an argument that the reflexives which are bound by *by*-phrases are not logophoric pronouns: “Inanimates cannot act as antecedents for logophors because they cannot hold perspective since they cannot be in a mental state (cf. Charnavel and Sportiche 2016).”

### 5.5 Accounting for the Data with Collins 2005a

How can such data be explained in terms of the Binding Theory? Consider the following standard formulation of the Principle A of the Binding Theory (Sportiche, Koopman and Stabler 2014: 168):

- (28) Principle A: An anaphor must be bound in its domain.

Now consider example (9c), with the structure sketched in (29):

- (29) \*The pictures were painted [<sub>PP</sub> near [<sub>DP</sub> the children]<sub>1</sub>] for [each other]<sub>1</sub>.

Clearly, the DP *the children* does not c-command the reciprocal (since it is dominated by the PP *near the children*). Therefore, the reciprocal does not satisfy Principle A.

What about the (a) sentences of (8-11)? In the theory of Collins 2005a, *by the children* is not even a constituent (see Angelopoulos 2019a for a similar analysis). The underlying structure of (8a) is as follows (irrelevant details omitted):

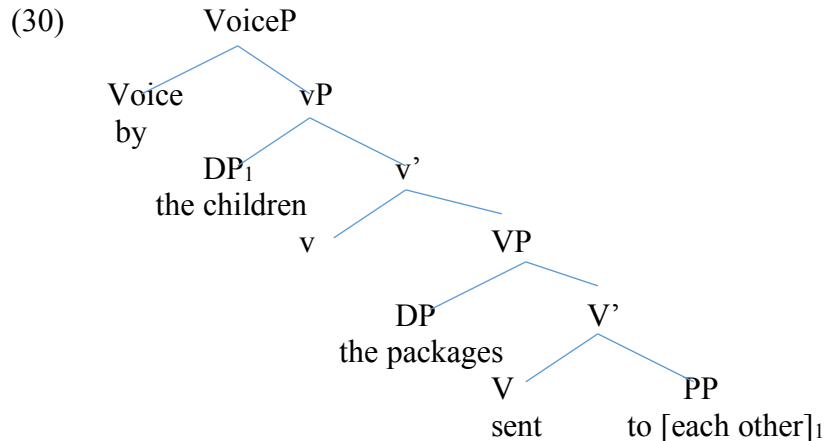

To derive the structure for (8a), the DP *the packages* must move to the subject position, Spec TP, and the participial VP must move to Spec VoiceP. But it is clear from this structure that the DP *the children* c-commands (and binds) the reciprocal *each other*. Hence, given the structure in (30), there is no violation of Principle A.

A problem with this account is that it predicts that if the reflexives in the (b-d) sentences in (8-11) are replaced by pronouns, they should be acceptable:

- (31) a. \*The packages were sent by the children to them. (predicted \*)  
 b. ?The packages were sent for the children to them. (predicted OK)  
 c. ?The packages were sent on behalf of the children to them. (predicted OK)  
 d. ?The packages were sent because of the children to them. (predicated OK)
- (32) a. \*The pictures were painted by the children for them. (predicted \*)  
 b. ?The pictures were painted with the children for them. (predicted OK)  
 c. ?The pictures were painted near the children for them. (predicted OK)  
 d. ?The pictures were painted in spite of the children for them. (predicted OK)

Even though (31a) and (32a) are unacceptable, the other sentences in (31) and (32) do not seem completely acceptable, contrary to what the standard binding theory would predict. I do not have any insights into this for the moment.

## 5.6 An Alternative to Collins 2005a

Legate (2014: 79-81) criticizes Collins' 2005a claim that *by* heads a VoiceP, and therefore does not form a constituent with the following DP (see also Alexiadou et. al. 2018: 412, Bowers 2010: 52-53, Fábregas and Putnum 2020, Kiparsky 2011: 11, Postal 2010: 417 for related criticisms). These criticisms of Collins 2005a mostly revolve around the issue of movement of the *by*-phrase. Here is an example which illustrates the issues modelled on Collins (2005a: 110):

- (33) a. the person by whom the book was read  
 b. ?the person by whom the book was read to Mary  
 c. \*the person by whom to Mary the book was read

While (33b) is awkward, (33c) is completely unacceptable. But if VoiceP can move to Spec CP in (33b), VoiceP should be able to pied-pipe [to Mary] in (33c), since the dative PP is internal to VoiceP. Collins tries to address this in terms of economy conditions on pied-piping (see Collins 2005a: (70), (71)). But the paradigm at least raises the possibility that *by whom* is not a VoiceP in (33b), and that is the reason why (33c) is not possible.

I will not review other criticisms of Collins 2005a, but instead I will consider how much of the approach in Collins 2005a can be maintained if one assumes that there is a *by*-phrase constituent. Therefore suppose, contra Collins 2005a, that *by the children* is a constituent, but it is generated in Spec vP in the passive, as in the following partial diagram of (8a). I label the *by* phrase as KP instead of PP for reasons that will become clear below.

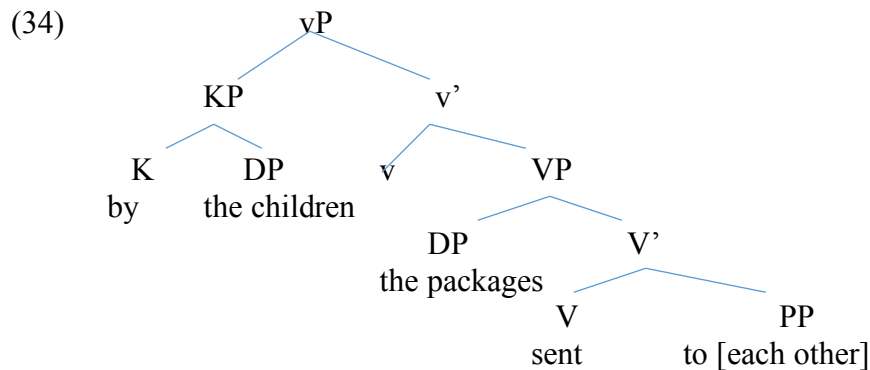

In other words, in (34) the *by*-phrase is an argument (since it occupies Spec vP, an A-position), as opposed to an adjunct. See Borer (1998), Bowers (2010: 41), Goodall (1997), Watanabe (1993: 337), Mahajan (1994: 297) and Hallman (2021: 159) for related approaches involving an argument *by*-phrase. See Fábregas and Putnam (2020) and Roberts (2019: 433) for KP analyses of the *by*-phrase.

I take it that case markers (heads of KP) are by definition semantically vacuous. If we assume that the *by* is semantically vacuous (denoting an identity function), then the denotation of the KP *by the children* would be identical to that of DP *the children*:

- (35) a.  $\llbracket \text{by the children} \rrbracket = \llbracket \text{the children} \rrbracket$   
 b.  $\llbracket \text{by} \rrbracket = \lambda x_e. x$

Myler and Mali (2021: 32) in their discussion of IsiXhosa causatives make a similar assumption about the instrumental causee: “We also assume that the apparently instrumental preposition in causative constructions is semantically null, so that the denotation of the PP containing the causee is the same as that of the cause itself.” See chapter 9 for a critical discussion of other proposals of Myler and Mali (2021).

Clearly, the DP *the children* does not c-command the reciprocal in (34). And so on this structure (8a) should be as bad as (8b-e). But on my analysis *by* heads a KP (along with the dative *to* and the nominal *of*), which is part of the extended projection of the DP. As such, the *by*-phrase itself can bind the reciprocal (just like any other case marked DP can bind a reciprocal in the right structural configuration).

- (36) The packages were sent  $[\text{KP by the children}]_1$  to  $[\text{each other}]_1$ .



In this structure, the KP *by the children* is co-indexed with the reciprocal *each other*.

I am assuming that the binding theory relates A-positions. For example, Chomsky (1981: 184) states: “The theory of binding is a theory of A-binding.” (see also Barss 2001: 671). Such an assumption is often invoked in the study of scrambling and object shift. In those studies, binding of an anaphor (e.g., short scrambling in Japanese) is taken to diagnose A-movement. Only if a DP has been moved to an A-position can it bind an anaphor. Since the binding theory relates A-positions, and since [<sub>KP</sub> *by the children*] binds a reciprocal, it follows that the KP is in an A-position.

A potential problem for this approach is pronominal agreement. Consider the examples in (10a) and (11a). The examples clearly show that the reflexive agrees syntactically with its antecedent. For example, in (10a) the reflexive *themselves* agrees in phi-features with its antecedent DP *the children*. But if the *by*-phrase were a PP, it would presumably have no phi-features and so it could not agree with a reflexive that takes it as an antecedent.

On my analysis, *by* heads a KP which is part of the extended projection of a DP. Since it is in the extended projection of the DP, it should have the same phi-features as the DP itself. See Angelopoulos, Collins and Terzi for a different solution based on the principles of pronominal agreement in Collins and Postal 2012.

A similar analysis would not rescue examples like the ungrammatical ones in (8-11). Prepositions such as *for*, *on behalf of*, *because of*, *via*, *with*, *near* and *amongst* would not qualify as KPs, and so PPs headed by them could not function as antecedents. First, none of these PPs are in A-positions, and so could not bind an anaphor. Second, none of these PPs would have phi-features which could agree with the pronoun they bind. Third, none of these PPs would have type <e>, and so presumably would not be the correct type to bind a pronoun.

Therefore, the KP analysis of *by*-phrases neatly explains the asymmetry between *by*-phrases and adjunct PPs illustrated in (8-11) above.

On the analysis sketched in (34), the correct word order would be derived by movement of PartP to Spec VoiceP (see chapter 6). Unlike in Bruening 2013 and Legate 2014, VoiceP does not play a role in projecting the external argument. Rather, VoiceP is a projection that appears with passives to account for word order and the licensing of the participial morphology. See chapter 7 for a comparison of the two different conceptions of VoiceP.

## 5.7 Responding to Collins 2005a

Perhaps the most compelling reasons that Collins 2005a gives for making *by* the head of VoiceP has to do with the distribution of *by*-phrases. Collins 2005a puts it as follows:

- (37) “Furthermore, the account I presented (see (22)) leaves unexplained the distribution of the *by*-phrase in English. Why is the *by*-phrase restricted to the external argument? Why can’t *by*-phrases occur in other syntactic positions? ... In fact, the problem is more general. What would block *by*-phrases from occurring in all kinds of positions? For example, why couldn’t a *by*-phrase appear in nominals such as *the leg of (\*by) the table* or *student of (\*by) physics*, and in the complement position of an adjective *proud of (\*by) his son*, and in certain subject positions *for (\*by) John to be happy*. ... Facts such as these make it clear that on the analysis of the passive proposed in the preceding sections we need to impose a requirement on the *by*-phrase that it appear in Spec<sub>vP</sub>: [<sub>vP</sub> [<sub>PP</sub> *by* DP] <sub>v</sub>]. The question is how such a requirement could be imposed.”

The solution Collins 2005a gives for this distributional problem is to assume that *by* is the head of VoiceP, which has a vP complement. For example, the reason that *the leg by the table* is unacceptable is that there is no vP internal to the DP that VoiceP can take as a complement.

On the KP analysis, there must be some constraint that forces the *by*-phrase to appear in Spec vP, instead of any other position. The generalization is the following:

(38) [by DP] appears in Spec vP (and no other position).

I propose that *by* has a c-selectional feature which constrains it to appear in Spec vP. In particular, I propose the following:

(39) *by* has c-selectional feature [\_\_vP]

The technical framework assumed in this account is that of Collins and Stabler (2016: 62): “We call the features involved in triggering Merge ‘trigger features’. We assume that such features are to be identified with subcategorization features, EPP features and OP features for movement to Spec CP...”.

Like all trigger features, the feature in (36) is checked under sisterhood (see Collins and Stabler 2016). When *by* is merged with a DP, the resulting syntactic object will have the trigger feature [\_\_vP]. Therefore, it will need to merge with a vP.

The above account also makes sense in terms of the labeling system of Chomsky 2013. Consider the following structure, where Voice c-selects vP as part of its lexical entry.

(40) [VoiceP Voice [vP [by DP] [v' v PartP]]]

In this structure the *by*-phrase stays in-situ, since it does not move to Spec TP (unlike the subject in an active). Therefore, vP has two daughter nodes, both of which are complex. This situation raises issues with regard to labeling (see Chomsky 2013: 43).

(41) “The interesting case is SO = {XP, YP}, neither a head...Here minimal search is ambiguous, locating the heads X, Y of XP,YP, respectively. There are then two ways in which SO can be labeled: (A) modify SO so there is only one visible head, or (B) X and Y are identical in a relevant respect, providing the same label, which can be taken as the label of SO.”

In the structure in (40), neither the *by*-phrase nor the v' phrase undergo movement, so clause (A) is inapplicable. Rather I propose that clause (B) is applicable. The *by*-phrase and the v'-phrase both share a v-feature, so the [vP [by DP] [v' v PartP]] has a label, and this label can be c-selected by VoiceP.

## 5.8 Other Diagnostics

In this chapter, I have shown that a *by*-phrase can bind a reflexive or a reciprocal. From that I have concluded that the *by*-phrase is in an A-position. In this short section, I will show very briefly that *by*-phrases enter in all the other syntactic relations that I have been discussing in this monograph. To the extent that these other syntactic relations require an antecedent in an A-

position, they provide additional support for my analysis of *by*-phrases (and against a Bruening style analysis where *by*-phrases are adjuncts with a semantically complex preposition):

- (42) Helke Expressions  
That book was written [by John]<sub>1</sub> on his<sub>1</sub> own.
- (43) *by x-self*  
That book was written [by John]<sub>1</sub> all by himself<sub>1</sub>.
- (44) Depictive Secondary Predicates  
a. Breakfast is usually eaten [by the campers]<sub>1</sub> [PRO<sub>1</sub> nude].  
b. The book was written [by John]<sub>1</sub> [PRO<sub>1</sub> drunk]
- (45) Argument Control (control into an argument infinitival clause)  
It was decided [by all present]<sub>1</sub> [PRO<sub>1</sub> to forgo desert].
- (46) Adjunct Control  
The book was written [by John]<sub>1</sub> [PRO<sub>1</sub> to impress his wife].
- (47) Adjunct Control  
That book was written [by John]<sub>1</sub> while PRO<sub>1</sub> working at a bakery.

Consider argument control in (45). In the theory of this monograph, PRO is controlled by the *by*-phrase (which is externally merged in Spec vP). Presumably, for Bruening 2013 the *by*-phrase (which is a function of functions) would not be a suitable controller. The only remaining possibility would seem to be formulating a semantic theory of control (not needing any syntactically projected antecedent). Similar problems arise for all the cases illustrated in (42-47 above).

## 5.9 Greek *by*-Phrases

The data concerning *by*-phrases and binding in English can be replicated in Greek, adding cross-linguistic support to the conclusions of this chapter. All the data and generalizations in this section comes from Angelopoulos, Collins and Terzi (2020).

The *by*-phrase in a Greek passive has a wide range of possible interpretations, just like in the English passive. See Jaeggli 1986: 599) and Collins (2005: 20). In the data below, the *by*-phrase is interpreted as an agent, experiencer, recipient, instrument and also as the subject of an idiomatic expression. Angelopoulos et. al. also show that *by*-phrases can be causers (not shown here).

- (48) Ta mallia mu stegno-thikan apo tin komotria.  
the hair mine dried-NACT.PAST.3P by the hairdresser.  
'My hair was dried by the hairdresser.'
- (49) I Maria aghapi-thike poli apo ton adra tis.  
the Maria love-NACT.PAST.3S a lot by the husband her

‘Maria was loved a lot by her husband.’

- (50) I tenia pu misi-thike apo ton spudheo skinotheti.  
 the movie that hate-NACT.PAST.3S by the important director  
 ‘The movie that was hated by the important director.’
- (51) To ghrama paralif-thike apo ton Emona.  
 the letter receive-NACT.PAST.3S by the Emona  
 ‘The letter was received by Emonas.’
- (52) I epifania tha kopi ce tha  
 the surface will cut.NACT.PAST.3S and will  
 charah-ti apo to laser.  
 engrave-NACT.PAST.3S by the laser  
 ‘The surface will be cut and engraved by the laser.’
- (53) Tha enimerο-thike apo kapjo pulaci.  
 must inform-NACT.PAST.3S by some little.bird  
 ‘He must have been filled in/informed by some little bird.’

This kind of data indicates that the preposition *by* does not assign its own theta-role. Rather, the interpretation of the external argument in the passive mirrors the interpretation in the active. And just like Chomsky’s argument based on selectional restrictions (see chapter 1) such data would be accounted for if external arguments were projected in the passive exactly the same way as in the active (having the same range of interpretations, depending on the particular verb).

Recall that in English a *by*-phrase can bind a reflexive, which indicates that *by*-phrases are arguments (assuming that the Binding Theory relates DPs in A-positions). In exactly the same way, Greek *by*-phrases can bind a reflexive pronoun:

- (54) Ena technito skafos pu kataskevas-tike apo tus theus<sub>1</sub>  
 an artificial craft that make.NACT.PAST.3S by the Gods  
 ja tus eaftus tus<sub>1</sub>.  
 for the self.ACC.P their.GEN  
 ‘An artificial aircraft that was made by the Gods for themselves.’
- (55) To minima apostel-ete apoklistika apo kathe Learner<sub>1</sub>  
 the message send-NACT.PAST.3S exclusively by every Learner  
 ston eafto tu<sub>1</sub>.  
 to.the self.ACC.S his.GEN  
 ‘The message is sent by every learner exclusively to himself.’

There is also an argument/adjunct asymmetry in Greek that is very similar to what is found in English. While a *by*-phrases can bind a reflexive, other adjunct PPs fail to do so.

- (56) a. Aftes i bluzes epilech-tikan apo ta phedhja<sub>1</sub>  
 these the t-shirts select-NACT.PAST.3P by the kids

- ja ton eafto tus<sub>1</sub>.  
for the self.ACC.S their.GEN  
'These t-shirts were selected by the kids for themselves.'
- b. \* Aftes i bluzes epilech-tikan brosta/ koda s-ta phedhja<sub>1</sub>  
these the t-shirts select-NACT.PAST.3P in front/ near at-the kids  
ja ton eafto tus<sub>1</sub>.  
for the self.ACC.S their.GEN  
'These t-shirts were selected in front/near the kids for themselves.'
- c. Aftes i bluzes epilech-tikan brosta/ koda s-ta phedhja  
these the t-shirts select-NACT.PAST.3P in front/near at-the kids  
ja afta ce tis ikojenies tus.  
for them and the families their.GEN  
'These t-shirts were selected in front/near of the kids for them and their families.'

Why is the Greek data important? First, it shows that the relatively subtle effect of binding by *by*-phrases (and the contrast with adjuncts) can be completely replicated in a different language. This gives us confidence that the principles that determine the effect in the first place are principles of UG.

Second, as Angelopoulos et. al. (2020: 8) show, Greek differs from English in not having exempt anaphora: "There is a relevant property of *o eaftos mu*, however, which makes it different from the English reflexive, but has received little attention, and this is that it has no usages that do not fall under standard Condition A." But this property of reflexive pronouns in Greek eliminates the possibility of analyzing the Greek data in (54-56) in terms of exempt anaphora. Angelopoulos et. al. put the conclusion as follows: "Given that *o eaftos mu* resists logophoric usages...it makes sense to assume that in the examples to be discussed in the following section we have clear cases of non-logophoric reflexives that are standardly analyzed as being subject to Condition A."

Third, these facts and the analysis of *by*-phrases they support bear directly on the analysis of non-active voice in Greek, as discussed in more detail in chapter 7. The data in this section clearly show that non-active voice is consistent with the syntactic presence of the external argument (in Spec vP). For example, 'select' is in the non-active voice in (56a), but it still has an external argument: [apo ta phedhja]. One popular analysis of non-active voice (Embick 1998) reduces the presence of non-active voice to the absence of an external argument. But the data presented in this section show such an analysis does not work.

## 5.10 Bruening 2013

Now let's reconsider a theory like that of Bruening 2013 (similar remarks hold for Legate 2014) with respect to the data in (5-8). On Bruening's theory the *by*-phrase is an adjunct, and the preposition *by* has a complex denotation (denoting a function of functions). Like other adjuncts, the DP inside the PP adjunct should be incapable of binding an anaphor.

Furthermore, on Bruening's theory it would not be possible for the *by*-phrase itself to act as an antecedent. First, *by*-phrase is not in an A-position (it is an adjunct), and the binding theory is limited to relations between A-positions. Second, the *by*-phrase does not satisfy equation (35b) on Bruening's theory (rather, it denotes a function of functions). And so it would make no sense

to say that the *by*-phrase itself is the antecedent of a pronoun. Third, the *by*-phrase itself has no phi-features, and so could not bind a pronoun (which agrees in phi-features with its antecedent).

On Bruening's theory, the passive and active are semantically equivalent: "Actives and passives with *by* phrases are truth-conditionally equivalent." (pg. 25) Therefore, it might be possible to save Bruening's theory by stating the Binding Theory as a semantic condition of some kind. In other words, it may be possible to save Bruening's theory by giving up the assumption that the Binding Theory is syntactic in nature, a conclusion that I would view as a reduction ad absurdum. Furthermore, given the data in section 5.8, such a semantic approach would necessitate giving a semantic treatment to obligatory control, adjunct control, secondary predicates and binding of pronouns in Helke expressions.

### 5.11 Consequences for Implicit Arguments

I have argued above that the *by*-phrase in the passive is not an adjunct (contra Bruening 2013 and Legate 2014). Rather, the *by*-phrase is a KP externally merged into Spec vP in the passive, as outlined in section 4. Then the passive and the active are parallel, both involve an argument in Spec vP. The conclusion is that Spec vP is always filled. The immediate consequence of this proposal is that even in the short passive (where there is no *by*-phrase), Spec vP must be filled.

Consider the following example:

(57) The book was read (by John)

And consider the following argument:

- (58) a. When [<sub>KP</sub> by John] is present, it is in Spec vP.  
b. Therefore, Spec vP is a theta-position.  
c. The long and short passive have the same *v*. That is, there are not two different kinds of *v*, one for long passives and one for short passives.  
d. Therefore, in the short passive, Spec vP is also a theta-position.  
e. Therefore, in the short passive, Spec vP must be filled.

The only potentially controversial statement is (58c). But it seems like the null hypothesis, until one finds evidence from some language that the two kinds of little *v* (for short and long passives) are morphologically, syntactically or semantically distinguished.

In other words, our conclusions about the syntax of *by*-phrases in the passive entails that there is a syntactically realized implicit argument in the short passive. Not surprisingly, both Bruening (2013: 22) and Legate (2014: 41) reject this conclusion.

Therefore, the conclusions reached in this chapter about the syntax of *by*-phrases dovetail nicely with the conclusions reached in chapters 2 and 3 about the syntactic presence of implicit arguments.

### 5.12 Optionality

It is commonly claimed that the optionality of the *by*-phrase shows that it is an adjunct or shows that it is not an argument. Consider the following quotes from Grimshaw (1990: 145-146):

- (59) a. “But regardless of whether *by* phrases are arguments of verbs or of *-en*, a major problem for this view is that the *by* phrase or its counterpart is optional in every language.” (pg. 145)  
 b. “The fact that passive *by* phrases are optional as far as a-structure is concerned cannot be explained under any account in which *by* phrases are arguments...” (pg. 146)

In my framework, *by* phrases are indeed optional, but external arguments are not. Consider again the following paradigm:

- (60) a. John wrote the book.  
 b. The book was written by John.  
 c. The book was written.

In the passive sentences in (60b,c), the *by*-phrase is optional, but it is also the case that *by*-phrases are arguments (contra Grimshaw 1990). In my framework, the external argument is always required in (60), but it is externally merged in two different ways: either as a *by*-phrase or an implicit argument. So there is absolutely no contradiction between the optionality of *by*-phrases and their status as arguments.

### 5.13 Conclusion

In this chapter I have shown that *by*-phrases in passives do not behave like adjuncts with respect to the Binding Theory in both English and Greek. I have shown that this difference follows without any further stipulations from the theory of *by*-phrases as arguments, but remains a complete mystery in such theories as Bruening 2013 and Legate 2014.

I have proposed a modification to the theory in Collins 2005a, where the preposition *by* is not the head of VoiceP, but rather heads an argument KP. I have shown that the proposed modification also accounts for the difference between *by*-phrases and adjuncts with respect to the binding theory.

The two theories can be summarized as follows:

- (61) Breuning 2013 (see also Legate 2014)  
 a. Syntactic status of *by*-phrase: adjunct PP  
 b. Semantic value of *by*:  $[[by]] = \lambda x \lambda f_{\langle e, st \rangle} \lambda e. f(e, x)$
- (62) This monograph:  
 a. Syntactic status of *by*-phrase: argument KP  
 b. Semantic value of *by*:  $[[by]] = \lambda x_e. x$

In (61), the complex semantics of the preposition *by* is needed to glue the external argument semantically to the rest of the structure (a VoiceP). In this way, Bruening 2013 and Legate 2014 inherit the problems inherent in the Principles and Parameters view of the passive. As Collins (2005: 83) notes: “The main problem with Jaeggli’s analysis is that the external argument in the passive is assigned a theta-role (via theta-role absorption and transmission) in a way that is totally

different from how the external argument is assigned a theta-role in the active (in Spec,IP in the principles and parameters framework).” In (62), the semantics of *by* is trivial, because the *by*-phrase is an argument.

More generally, what this section has shown is that there are two different approaches to *by*-phrases in the passive both compatible with many of the same facts (e.g., range of theta-roles of external arguments, binding theory). In Collins 2005a (see also Angelopoulos 2019), I analyzed *by* as the head of VoiceP. In this monograph, I am assuming that *by* is the head of KP. But the choice between the two analyses is subtle, and it is unclear what principles of UG would force one analysis over the other. I am hoping that this monograph will stimulate research into this issue, perhaps identifying different groups of languages that make use of each strategy.

I have not discussed *by*-phrases in nominalizations. Simon (2018) gives the following data:

- (63) a. the criticism of himself<sub>1</sub> by John<sub>1</sub>  
b. \*the criticism of him<sub>1</sub> by John<sub>1</sub>  
c. \*the criticism of John<sub>1</sub> by him<sub>1</sub>
- (64) a. the criticism by John<sub>1</sub> of himself<sub>1</sub>  
b. \*the criticism by John<sub>1</sub> of him<sub>1</sub>  
c. \*the criticism by him<sub>1</sub> of John<sub>1</sub>

Simon points out that binding in nominalizations obeys Principles A, B and C of the Binding Theory. On the basis of this data, he gives an analysis of the internal structure of nominalizations very much in the spirit of Collins 2005a. The next step would be to see if the difference between *by*-phrases and other prepositional phrases discussed above (with respect to Principle A of the Binding Theory) could be replicated internal to nominalizations.



## 6 Some Sample Derivations

In this chapter, I give the complete derivation of passive sentences, both with and without the *by*-phrase, in order to illustrate the principles discussed in this monograph. Consider the following paradigm from the introduction. We will start with (1b):

- (1) a. John wrote the book. (active)  
b. The book was written by John. (passive)  
c. The book was written. (short passive)

I will put aside the issue of whether there are acategorial roots, and how they enter into the syntactic derivation, and simply assume that there is a verb *write*. This verb heads a VP, which takes the DP *the book* as a complement. I will also assume that the complement position of the VP headed by *write* is a theta-position (and is therefore obligatorily projected). These decisions ignore many issues about the internal structure of the VP (e.g., the position of particles, resultatives, double objects, etc.)

### 6.1 Passive with *by*-Phrase

Since *write* is in its participial form, I assume that there is a suffix Part which projects a PartP. Unlike in the Principles and Parameters analysis of the passive, I do not assume that the participial suffix *-en* absorbs accusative Case or the external theta-role (see Collins 2005a for discussion). In fact, the arguments are projected in the active in the same way that they are projected in the passive, there is no room for theta-role absorption.

Furthermore, I assume that Part is merged with VP (not vP). This assumption captures the fact that in a language like French there is sometimes participle agreement with an object, but never with an external argument.

Putting these assumptions together we have:

- (2) [<sub>PartP</sub> Part [<sub>VP</sub> write [<sub>DP</sub> the book ]]]

Following Collins (2005: 90), I assume that past participles have an uninterpretable feature that can be checked either by moving PartP into Spec VoiceP, or by the c-commanding auxiliary verb *have*.

- (3) A participle (PartP) must be licensed by  
a. being c-selected by the auxiliary *have* or  
b. moving to Spec VoiceP.

Next, the external argument is introduced. I assume that external arguments are introduced in Spec vP. By the Theta-Criterion, Spec vP needs to be filled in the passive (since it is filled in the active, and there is no difference between little *v* in the passive and the active).

The only two possibilities for filling Spec vP are the DP *John* and the *by*-phrase [by John]. In Collins (2005), I explored the possibility that the DP *John* itself occupies Spec vP in the passive. In this monograph, I am exploring the possibility that the *by*-phrase occupies Spec vP. See chapter 5 for discussion.

(4)

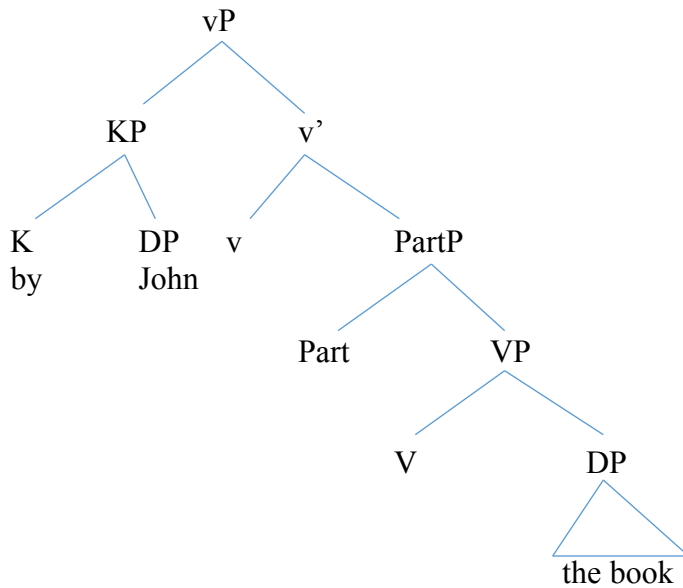

In this structure, I am assuming that the KP is part of the extended projection of the DP *John* (see chapter 5). Since KP is in Spec vP, which is a theta-position, the Theta-Criterion is satisfied.

Recall from chapter 5, that the *by*-phrase has a limited syntactic distribution, appearing only in Spec vP. I proposed there that *by* has a [ $\_\_$ vP] c-selection feature. Such a feature would be checked under sisterhood with v' in (4).

Suppose that the derivation continued from (4) by merging in the copula and T and then raising the KP to Spec TP (with no VoiceP):

- (5) a. [TP [KP *by John*] [T' T [VP *was* [vP <KP> *written the book*]]]]  
b. \**By John was written the book.*

There are a number of problems with the structure in (5a). First, English does not in general have oblique subjects (e.g., dative subjects), so whatever principle blocks oblique subjects in English should also block (5a). Second, since the Case features of *John* are checked in Spec vP (by the KP), it should be frozen in place by the Activity Condition (Chomsky 2000: 123), with no possibility of moving to Spec TP. Third, since there is no VoiceP in (5), the uninterpretable participle feature of PartP will remain unchecked (see (3) above).

Suppose in (5) *was* is replaced by *has*:

- (6) a. [TP [KP *by John*] [T' T [VP *has* [vP <KP> *written the book*]]]]  
b. \**By John has written the book.*

In (6), the participle is now licensed (see (3a)), but the KP in Spec vP still causes problems since it cannot move to Spec TP (since it is frozen in Spec vP by the Activity Condition).

Consider another possible derivation continuing on from the structure in (4). This time, the copula and T are merged (there is still no VoiceP), but the object raises to Spec TP (instead of KP raising):

- (7) a. [TP [DP the book] [T' T [VP was [vP [ by John] written <[the book]>]]]]  
 b. \*The book was by John written.

The uninterpretable feature of the participle is unchecked here, but replacing *was* by *has* does not result in an improvement, even though according to (3) above *has* should be able to check the uninterpretable participle feature.

- (8) a. [TP [DP the book] [T' T [VP has [vP [ by John] written <[the book]>]]]]  
 b. \*The book has by John written.

One problem with (7) and (8) is that T is separate from *the book* by a phase boundary, and therefore T cannot probe into the complement of v to agree with it. But if T cannot agree with *the book*, then *the book* cannot be raised to Spec TP.

Another problem with both (7) and (8) is that they involve raising the object DP over the KP in Spec vP. This should result in a violation of Relativized Minimality or the MLC of minimalist syntax.

Consider the classical definition of Relativized Minimality:

- (9) Relativized Minimality (Rizzi 1990: 7)  
 X  $\alpha$ -governs Y only if there is no Z such that:  
 (i) Z is a typical potential  $\alpha$ -governor for Y.  
 (ii) Z c-commands Y and does not c-command X
- (10) Z is a typical potential antecedent governor for Y, Y is an A-chain =  
 Z is an A specifier c-commanding Y.

In the example in (7), the KP [by John] is certainly in an A-position (a Theta-Position), and the object [the book] has undergone A-movement. So by (9) and (10) the derivations should have been blocked by RM.

Consider now MLC. Suppose that T has unvalued phi-features [uPhi] that need to be valued. When T probes downward in (8a) looking for a matching goal (before movement of [the book]), the search will encounter the KP [by John]. But since the KP is part of the extended projection of *John* (see chapter 5 for more discussion), whatever phi-features are visible at the DP level should also be visible at the KP level (that is why the KP can bind a reflexive pronoun, see chapter 5). But if the probe matches KP, by Minimal Search, it will be unable to continue probing to find the DP object (a so-called case of defective intervention, see Chomsky 2000: 123).

Clearly, the derivations in (5-8) are ruled out, and in all cases it seems that the external argument in Spec vP is causing problems. Once again continuing on from (4), consider the possibility of moving the PartP over the external argument, smuggling the object over the external argument (see Collins 2005a, and Belletti and Collins 2020 for works on smuggling). Voice is merged, PartP moves to Spec VoiceP to check its uninterpretable features (see Collins 2005a).

- (11) [VoiceP PartP [Voice' Voice [vP KP [v' v <PartP> ]]]]

Lastly, the copula is merged, T is merged, and the object DP raises to Spec TP, yielding the following structure:

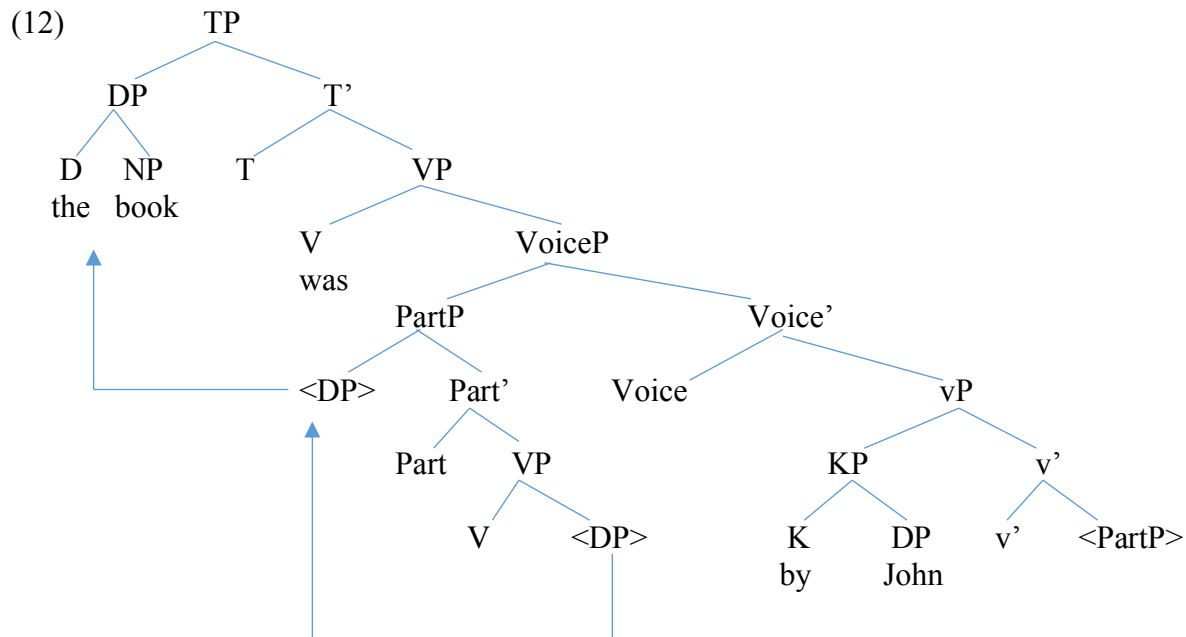

In this structure, T agrees with the object DP in Spec PartP, and then the object DP moves to Spec TP to satisfy the EPP feature of T. Movement of the object DP to Spec TP moves through Spec PartP (as can be seen by participle agreement in the passive in languages such as French).

What about accusative Case? In the Principles and Parameters theory, the passive suffix *-en* absorbed the accusative Case of a verb as well as the external theta-role. I do not make these assumptions about the passive suffix *-en* here. But that leaves the question of why the object is not assigned accusative Case in (12).

The intuition I will pursue is that movement of the PartP raises the object into a position accessible to T, and so the phi-features of T can agree with DP. In those circumstances, little *v* does not check the Case feature of any DP.

More precisely, the movement of the PartP in (12) results in five occurrences of the DP *the book* (see Collins and Stabler 2016 the definition of occurrence). The highest occurrence is in Spec TP, but each occurrence of the PartP dominates two occurrences of the DP as well. Consider the occurrence in Spec PartP (itself in Spec VoiceP). This occurrence is c-commanded by the Case checker T, but not the Case checker *v*. Under those conditions, Agree(T, DP) can be formed, and the Case of the DP can be checked (as a reflex of Agree). In this case, the Case checker *v* does not check the Case of any DP.

In fact, there are unergative verbs that take an optional cognate object which seem to show that *v* does not obligatorily check the accusative Case of an object: “John laughed a big laugh.” Similarly, there are unergative verbs that take so-called fake reflexives: “John laughed himself silly.” These kinds of examples show that unergative *v* can check accusative case, but is not required to do so. Similarly, I am proposing that in (12), PartP moves away from little *v*, which then no longer checks accusative case.

Suppose instead of movement of PartP to Spec VoiceP, a structure with a rightward specifier of vP was generated:

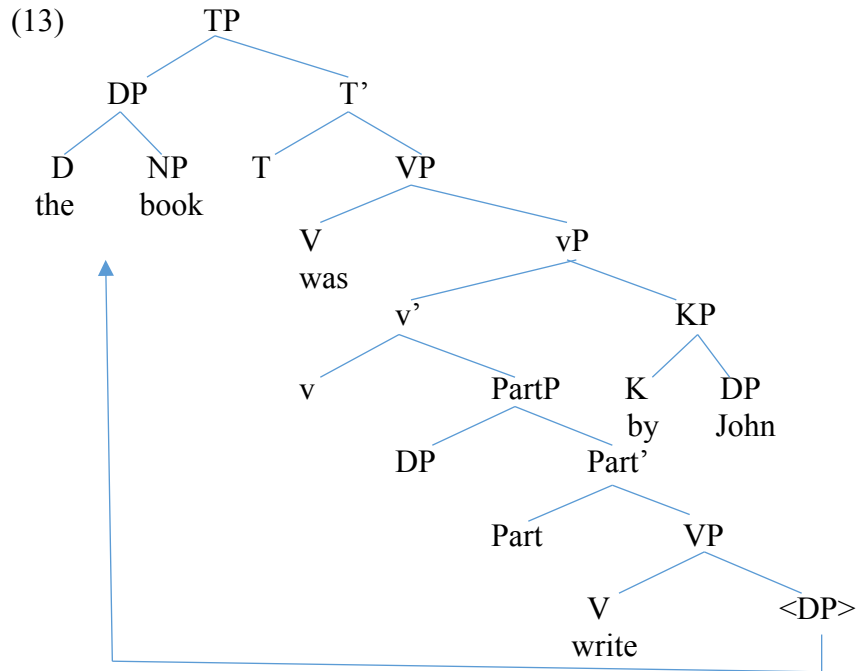

At first sight, this structure is appealing because it yields a rightward position of the *by*-phrase without any smuggling. However, it is not a tenable analysis. The first problem is that clear cases of specifiers (Spec DP, TP, CP) are all leftward in English. So, the rightward specifier of vP would be the odd one out. Second, the rightward specifier in (13) violates Kayne's 1994 Linear Correspondence Axiom (LCA). Third, such an analysis yields false predictions about c-command. It predicts that the *by*-phrase should c-command whatever is found in the preceding VP. But Collins 2005a shows in detail that such a prediction does not hold. I repeat some of the core data here:

- (14)
- a. \*The book was given to any student by no professor.
  - b. \*The book was given to the other by each professor.
  - c. The book was given by no student to any professor.
  - d. The book was given by each professor to the other.

Therefore, because of these three reasons, I reject the rightward specifier analysis in (13).

Consider lastly a derivation where PartP moves to Spec Voice, but DP (not KP) merges into Spec vP. The structure is given in (15).

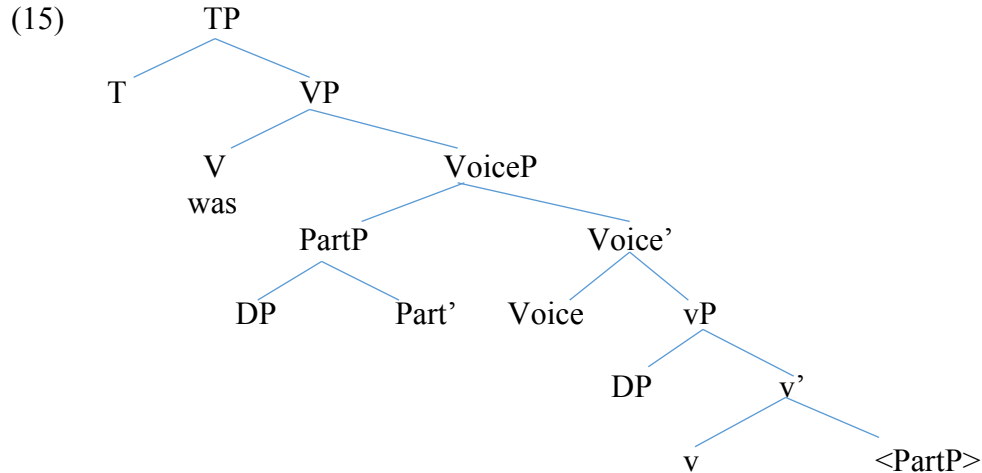

Continuing on from (15), there are two possibilities: either T agrees with and checks the Case of the external argument (EA) or T agrees with and checks the Case of the direct object DO. Suppose that Agree(T, DO), then the EA will violate the Case filter (unless it is implicit argument pro). Suppose Agree(T, EA). One possibility is that the Agree relation is blocked by the intervening PartP in Spec VoiceP (an MLC violation). After all, Spec PartP is filled by the object, and that might be enough to block Agree(T, EA).

## 6.2 Short Passive

Now consider the derivation of the short passive in (1c). Everything about this derivation is identical to (12), except the external argument is now a small pro implicit argument (see chapter 4 for the general theory of implicit arguments):

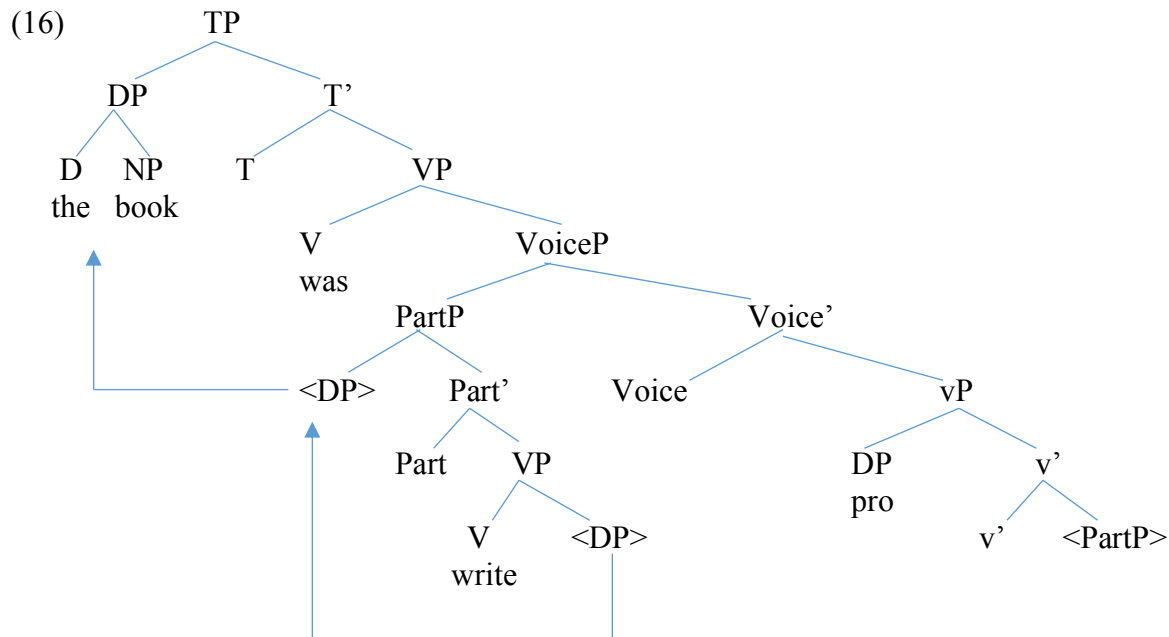

In this structure, the DP *pro* satisfies the Theta-Criterion. The *pro* is licensed because it occupies a Caseless position (Spec vP). Semantically, it is interpreted as a variable bound by a generic operator, or as a pronoun with a definite DP as an antecedent (as discussed in chapter 2). There is also the possibility that UN (null existential quantifier) can appear in the position of *pro*, giving an existential interpretation. Since the implicit argument is syntactically projected in (16), it should give rise to Principle A, B and C effects. On a detailed discussion of binding in passives, see chapters 2 and 5, and Collins 2005a.

A parallel between (12) and (16) is that in both cases the external argument is trapped in Spec vP, unable to raise to Spec TP. In this case, movement of the PartP to Spec VoiceP smuggles the object over the external argument, rendering it accessible to T.

### 6.3 Active

Finally, returning to the active, suppose that the DP *John* is merged into Spec vP, but that there is no participle or VoiceP:

(17) [TP John [T' T [vP <John> [v' v [VP write [DP the book]]]]]]

Here there is no problem. T agrees with the external argument DP, which raises to Spec TP. The Case of the object is checked by v.

Suppose instead that the KP is merged into Spec vP, essentially an active with a *by*-phrase:

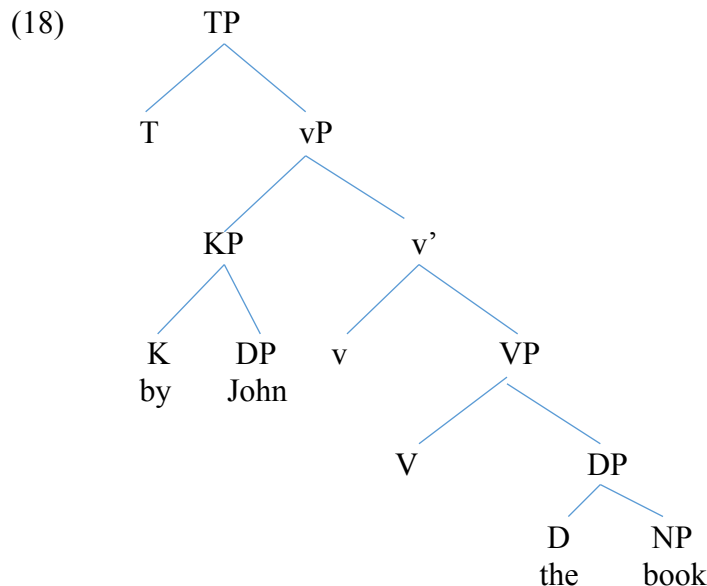

Nothing prevents the *by*-phrase from being merged into Spec vP here. The Theta-Criterion is satisfied, and the syntactic features of *by* are checked. However, there are other problems. First, English does not in general have oblique subjects (e.g., dative subjects), so whatever principle blocks oblique subjects in English should also block (18). Second, since the Case features of *John* are checked in Spec vP (internal to the KP), it should be frozen in place by the Activity Condition (Chomsky 2000: 123), with no possibility of moving to Spec TP, resulting in an unchecked EPP

feature for the finite T. Third, the accusative Case of the object is checked by v, and so there is no possibility that the object could raise to Spec TP (the Activity Condition).

## 6.4 Systematic Presentation of Derivations

In the previous section, I discussed a few derivations. In this section, I will take a more systematic approach. In the analysis of the passive in this monograph, there is no passive construction. Rather there are morphemes each with their own properties that are merged together constrained by economy principles and interface conditions. Putting aside the issue of implicit arguments for now, there are four choices to make: (a) auxiliary selection: *was*, *has* or zero, (b) presence or absence of Voice, (c) presence or absence of K, (d) presence or absence of Part. In total, there are  $3 \times 2 \times 2 \times 2 = 24$  combinations. In this section, I will systematically go through all the possibilities, and show that only three are acceptable (the passive, the active with *has* and the active without *has*).

Start first with sentences that have *was* as the auxiliary:

(19)	a.	T	was	Voice [K DP]	v	Part	VP
	b.	*T	was	Voice [K DP]	v		VP
	c.	*T	was	Voice DP	v	Part	VP
	d.	*T	was	Voice DP	v		VP

(19a) is just the passive, as discussed above: PartP moves to Spec VoiceP, then the object moves to Spec TP. (19b,d) are unacceptable because the VP cannot raise to Spec VoiceP, only PartP can. Because of this, Spec VoiceP remains unfilled. Concretely, I assume that Voice has an EPP feature, and that feature is not checked in (19b,d).

(20)	a.	*T	was	[K DP]	v	Part	VP
	b.	*T	was	[K DP]	v		VP
	c.	*T	was	DP	v	Part	VP
	d.	*T	was	DP	v		VP

(20a) and (20c) have a Part but nothing to check it (either *have* or Voice). In (20b), no DP can raise to Spec TP, leaving its EPP feature unchecked. In (20d), there is a bare (non-participle) verb (v+V) which combines with a copula. Whatever accounts for the contrast between *John will laugh* and *\*John was laugh* accounts for the unacceptability of (20d).

(21)	a.	*T	has	Voice [K DP]	v	Part	VP
	b.	*T	has	Voice [K DP]	v		VP
	c.	*T	has	Voice DP	v	Part	VP
	d.	*T	has	Voice DP	v		VP

All the options in (21) are ruled out because of the combination of *has* and Voice. These can never appear together, since they have a similar function (licensing a past participle). For example, in (21) PartP moves to Spec VoiceP, and is licensed there. It is not possible now for *have* to license the PartP a second time. Concretely, if the Part has an uninterpretable uPart feature, once it is deleted by Voice, it cannot be deleted again by *have*.



(22)	a.	*T	has	[K DP]	v	Part	VP
	b.	*T	has	[K DP]	v		VP
	c.	T	has	DP	v	Part	VP
	d.	*T	has	DP	v		VP

In (22a,b), no DP is available to move to Spec TP, leaving the EPP feature of T unchecked. (22c) is a grammatical sentence, where the external argument raises to Spec TP. (22d) is ruled out because *has* requires a participle.

(23)	a.	*T		Voice [K DP]	v	Part	VP
	b.	*T		Voice [K DP]	v		VP
	c.	*T		Voice DP	v	Part	VP
	d.	*T		Voice DP	v		VP

In (23), VoiceP is the complement of finite T, but VoiceP requires a PartP, and a PartP cannot appear with finite T. In other words, in all cases where VoiceP is present, a copula is also needed. For example, in (23a), PartP moves to Spec VoiceP, but this leaves a sentence where finite T is followed by a participle (and there is no copula). This is bad for whatever reason finite T cannot combine with participles: *\*John written*.

(24)	a.	*T		[K DP]	v	Part	VP
	b.	*T		[K DP]	v		VP
	c.	*T		DP	v	Part	VP
	d.	T		DP	v		VP

(24a,c) are ruled out because Part needs to appear with either *have* or Voice. (24b) is ruled out, because nothing can raise to Spec TP to check its EPP feature. In particular, the KP cannot move to Spec TP. Nor can the direct object, which is separated from Spec TP by a phase boundary. (24d) is acceptable. It is the active without a participle.

In summary, out of 24 possible combinations, only three are acceptable. Such a result provides striking confirmation of the general approach.

(25)	a.	Passive (19a)					
		T	was	Voice [K DP]	v	Part	VP
	b.	Active with participle (22c)					
		T	has	DP	v	Part	VP
	c.	Active without participle (24d)					
		T		DP	v		VP

## 6.5 Conclusion

In this chapter, I have given complete derivations of the passive, the short passive and the active. Even though I use expressions such as “passive construction”, there in fact is no passive construction in minimalist syntax. Rather, there are morphemes with their properties that are combined by Merge (internal or external). Some combinations of these morphemes yield

acceptable results and some do not. The combination involving *was*, Voice, KP and a participle is called the passive.

## 7 Two Conceptions of VoiceP

### 7.1 Introduction

In recent literature on argument structure, the VoiceP projection plays two distinct and incompatible roles. I will call the two theories the *Projection Theory* and the *Realization Theory*. On the projection theory, due to Kratzer 1996, VoiceP plays a central role in projecting the external argument of an active clause, see (1). On this theory, the external argument is externally merged as a specifier of VoiceP.

(1) Projection Theory

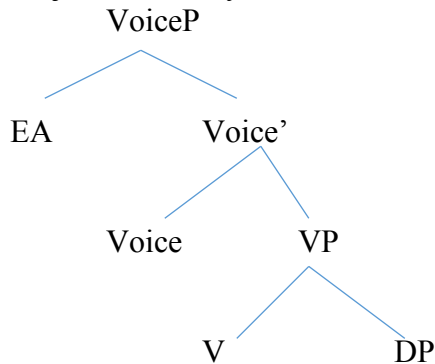

On the other theory, VoiceP has nothing to do with the external Merge positions of arguments. The external argument is not externally merged into Spec VoiceP, but rather it is externally merged into the specifier of vP (see Chomsky 1995, and also Collins and Thrainsson 1996). On the Realization Theory, VoiceP plays a role in how arguments are realized in A-positions (such as Spec TP). For example, in Collins 2005a, the presence of VoiceP makes it possible for the object of the active to move to Spec TP, and be realized as the subject of the passive.

The Realization Theory is illustrated in (2) below:

(2) Realization Theory

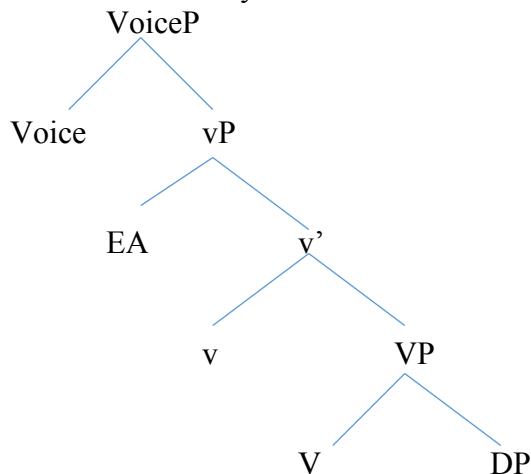

I summarize these two theories below:

- (3) a. Projection Theory:  
VoiceP plays a role in the projection (external Merge) of arguments.  
In particular, the external argument of the active is merged into Spec VoiceP.
- b. Realization Theory:  
VoiceP plays no role in the projection (external Merge) of arguments.  
Rather, VoiceP determines the A-positions of arguments.

In this chapter, which focuses on the passive in English for the most part, I will argue for the Realization Theory over the Projection Theory.

## 7.2 What is grammatical voice?

It is not the purpose of this chapter to give a survey of grammatical voice, or to offer a unified theory of constructions characterized by voice. But as a starting point, I adopt Doron's (2015: 749) characterization:

- (4) "Voice (diathesis) alternations are particular alternations, typically marked as part of the verb's morphology, in the assignment of grammatical functions to the verb's arguments."

In the Principles and Parameters tradition, grammatical functions are normally characterized in terms of A-positions: Spec TP, complement of the verb, etc. So, I reformulate the characterization of voice alternations as follows:

- (5) Voice alternations are typically marked as part of the verb's morphology and determine the realization of the verb's arguments in A-positions.

There are problems with this simple characterization. For example, in ECM constructions, the object is not an argument of the verb but can be passivized: *John was believed to be nice*. I put such problems aside, as (5) is sufficient for the purposes of this chapter.

Under such a characterization are found phenomena like the passive (including impersonal passives), antipassive, inversion (e.g., in Algonquian), and various kinds of middles (see Ackema and Schoorlemmer 2017 for a survey of middles).

The phenomena traditionally characterized as voice phenomena may have very different syntactic analyses. But whatever the analysis, the following terminological assumption should be adhered to:

- (6) Terminological Assumption  
Any theory of VoiceP must play a crucial role in accounts of voice phenomena (e.g., passive, inversion, middle). Equivalently, if a projection XP plays no role in accounting for voice phenomena, then it should not be called VoiceP.

This is a standard position on terminology in the field of generative syntax. A theory of FocP plays a role in the accounts of focus. A theory of AspP plays a role in accounts of verbal

aspect. A theory of NumP plays a role in accounts of number in the DP. If the VoiceP of some theory played no role in voice phenomena, it would not be advisable to label the relevant projection VoiceP.

### 7.3 Kratzer 1996

Kratzer develops her proposals about VoiceP within the neo-Davidsonian conception of event semantics. In particular, she suggests that the Voice head for agent has the following denotation:

$$(7) \text{ Agent*} = \lambda x_e \lambda e_s [\text{Agent}(x)(e)]$$

However, Kratzer (1996) presents no arguments at all that the functional head VoiceP has anything to do with voice phenomena, which seems to be explicitly acknowledged on page 120:

(8) “I will call it VOICE. This choice of name is not arbitrary. Kratzer (forthcoming) argues that Voice is truly at the heart of a theory of voice.”

In other words, there is no indication in Kratzer 1996 of how the VoiceP plays a role in the passive, middle, inverse voice, etc. And so Kratzer’s paper fails the Terminological Assumption (6) above.

But later authors do provide analyses that implicate VoiceP in voice phenomena. Perhaps the first such analysis is that of Pylkkänen (2008a: 26), who claims that there is an active Voice head, as well as a passive Voice head:

(9) “The inability of depictives to modify an implicit external argument is predicted, as long as we assume that passive Voice makes the external argument syntactically unavailable. In (35), I assume that passive Voice existentially closes off the external argument.”

Consider the following diagram (based on (35) of Pylkkänen 2008a: 26):

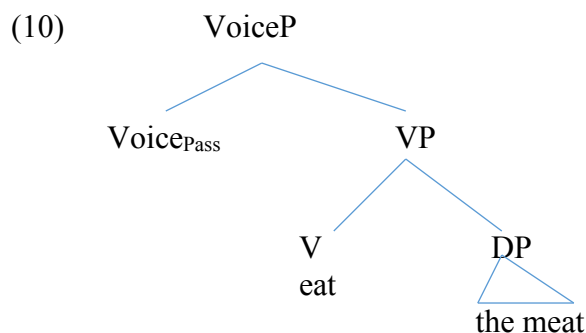

So, in Pylkkänen’s system there are two Voice heads: an active Voice head whose Spec contains the external argument and a passive Voice head that does not project a specifier. If Pylkkänen’s analysis is right, it would provide striking confirmation for Kratzer’s basic idea that the external argument is projected in Spec VoiceP. It would be exactly the kind of data needed by Kratzer to support her VoiceP analysis. Here is the reasoning: If the external argument is projected

in Spec VoiceP, then it could be the case that the projection of the external argument varies with the flavor of the Voice head (active or passive).

However, there are a number of severe empirical problems for Pylkkänen’s analysis of the passive. First, it is founded on the generalization that the implicit argument in the passive cannot be modified by a depictive secondary predicate (pg. 22): “...if the external argument is implicit, as in a passive, it cannot be modified by a depictive.” But I have shown in great detail in chapter 3 that this generalization does not hold. An example from Collins (2005: 101) is given below:

(11) At the commune, breakfast is usually eaten nude.

Furthermore, there is data discussed in chapter 2 (and other sources) that shows that the implicit argument of a passive can bind a reflexive pronoun:

- (12) a. Such privileges should be kept to oneself.  
(Baker, Johnson and Roberts 1989: 228, Roberts 1987: 162))  
b. Damaging testimony is always given about oneself in secret trials.  
(Roberts 1987: 162)

These sentences are predicted to be unacceptable by Pylkkänen’s theory in (10), because the reflexive pronouns have no antecedents. Rather, it seems that in the short passive there must be a null *pro* in Spec VoiceP that binds the reflexive, as argued extensively in chapters 2-4.

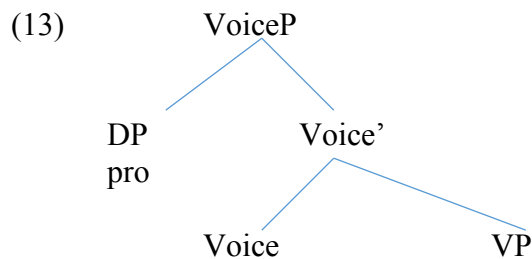

But then the external argument in the passive is projected in the same way as the external argument in the active, both are projected in Spec VoiceP. In other words, given (13) it is unclear that there is any distinction at all between the active and the passive VoiceP in English. And if there is no distinction, then there is no support from the English passive for the idea that the external argument is projected in Spec VoiceP.

A proposal related to Pylkkänen’s is that there is a  $\text{Voice}_{\text{PASS}}$  that selects for a *pro* specifier. This appears to be the analysis of Baker and Vinokurova (2009:528): “...the primary difference is that active voice typically takes an overt NP in its specifier position and passive voice takes a phonologically null NP, which is interpreted as a free variable.” This kind of analysis would be able to handle data like (12), since there is a syntactically projected external argument. But it is unclear why a distinction between active and passive Voice is needed here. The phonologically null *pro* falls under the general theory in chapter 4. There is no need to stipulate that there is a distinct passive Voice that “takes a phonologically null NP” in its specifier position.

One of the most well-worked out analyses of the passive in the VoiceP framework is Bruening 2013. In his theory, there is no difference between an active and a passive Voice head, they have exactly the same syntactic and semantic features. Bruening assumes that “...passive is

a head (Pass) that selects a projection of Voice that has not yet projected its external argument. I notate this [S: Voice(S:N)]. That is, Pass selects for a Voice with an unchecked [S:N] feature. This means that the complement of Pass is an unsaturated Voice projection...” (pg. 22).

The analysis is sketched below (modified slightly):

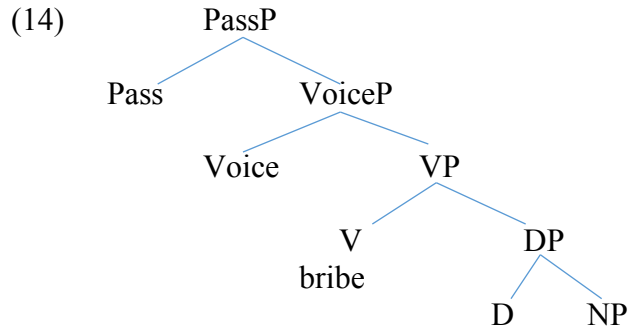

So in the passive, Spec VoiceP remains unfilled, but the Voice head has exactly the same features as in the active. Therefore, there is no difference between passive and active Voice heads for Bruening.

The surprising consequence of Bruening’s analysis is that even though he adopts Kratzer’s VoiceP framework, the VoiceP itself plays no essential role in the analysis of the English passive voice. Rather, all the work is done by PassP, which “...selects for a Voice with an unchecked [S:N] feature.” Clearly this situation represents a failure of the Terminological Assumption in (6). There is no reason internal to Bruening’s analysis of the passive that the head that introduces the external argument should be called Voice.

Consider next Alexiadou et. al. (2015), who adopt the VoiceP framework to analyze various voice-related phenomena, including the passive and anti-causatives in German and Greek. My discussion here closely follows that of Angelopoulos, Collins and Terzi 2020. Non-active voice is used in a variety of contexts: passives, reflexives and reciprocals, middles, deponent verbs and some anti-causative verbs. An example with a Greek active and passive (present and past tense) is given below (from Angelopoulos et. al. 2020: 2, (1)):

- (15)
- |    |   |            |                       |     |          |           |
|----|---|------------|-----------------------|-----|----------|-----------|
| a. | O   | kathijitis | chirokrot-i           | tus | fitites  |           |
|    | The   | professor  | applaud.ACT.PRES-3SG  | the | students |           |
|    | “The professor applauds the students.”          |            |                       |     |          |           |
|    |   |            |                       |     |          |           |
| b. | I   | fitites    | chirokrot-unde        | apo | ton      | kathijiti |
|    | the   | students   | applaud-NACT.PRES.3PL | by  | the      | professor |
|    | “The students were applauded by the professor.” |            |                       |     |          |           |
|    |   |            |                       |     |          |           |
| c. | I   | fitites    | chirokroti-thik-an    | apo | ton      | kathijiti |
|    | the   | students   | applaud-NACT.PAST-3PL | by  | the      | professor |
|    | “The students were applauded by the professor.” |            |                       |     |          |           |

Alexiadou et. al. 2015 propose that the non-active voice morphology in Greek marks the absence of Spec VoiceP:

- (16) “...we propose that a Voice head is spelled out with non-active morphology in Greek, if it lacks a specifier. In other words, the common property shared by passives and marked anticausatives in languages of this type is the lack of a syntactically projected external argument in Spec VoiceP.” (pg. 101)

Concretely, they adopt the analysis of Embick (1998, 2004) about the spell-out of Voice:

- (17) Voice → Voice[NonAct]/ \_\_ No DP Specifier.

But Angelopoulos, Collins and Terzi 2020 show that the *by*-phrase in the Greek passive behaves like an external argument in its ability to bind reflexives. Therefore, they conclude that the external argument in the passive and the active are projected in the same position (for them, Spec vP). From this, it follows that the presence of non-active voice is not sensitive to whether or not there is a syntactically projected external argument. But if the distribution of non-active voice is independent of the projection of an external argument, there can be no support for Kratzer’s theory from Greek.

Yet another influential paper using the VoiceP framework is Harley 2013, who argues that for Hiaki “...the external-argument introducing projection VoiceP...must be distinct from the verbalizing head...” (pg. 34). Harley (2013: 50) notes that in applicatives of causatives, the word order is the following:

- (18) ni’i-tua-ria  
fly-caus-appl

She assumes that the caus head is a flavor of little v. Now if cause itself introduces the causer, then because of the order of suffixes in (18), one would expect the applied DP to be higher than the causer DP, but it is not (as Harley shows). Rather, the causer subject is higher than the applied object. Therefore, it follows that (a) the caus head does not introduce the matrix causer subject and (b) there is another head, which introduces the matrix causer subject. As Harley (2013: 55) summarizes:

- (19) “The Mirror Principle problems posed by the interaction of the applicative and causative in Hiaki require that the head that introduces causative morphology and semantics be distinct from the head that introduces external arguments; that is, vP is not VoiceP.”

Harley (2013: 52) then claims that “...Voice should be the locus of Voice morphology – passive morphemes included.” If the proposed head, introducing the causer in examples like (18), was also the locus of passive morphology, that would be strong support for Kratzer’s (1996) program. As Harley (2013: 53) notes: “If the external argument is introduced separately by Voice, however, then passive Voice morphology can embed a causative v without requiring the presence of an external argument.” And in the diagrams (40) and (41) of Harley’s paper, passive VoiceP is clearly shown with no specifier.

This logic seems very similar to Pylkkänen’s account of the English passive presented above. And just like with Pylkkänen’s account one can ask if there really is no syntactically present external argument in the passive in Hiaki. Harley presents no relevant data. But if the relevant tests (e.g., reflexives, secondary predicates, Helke expressions, control etc.) showed that the external



argument was projected in the passive, then both active Voice and passive Voice would involve a projected external argument. Such a conclusion would raise the possibility that the projection of arguments is identical in the active and passive in Hiaki, making Harely's use of VoiceP to project the external argument suspect (since the projection of the external argument would be independent of voice).

#### 7.4 Collins 2005a

In Collins 2005a VoiceP is needed in the syntax of passive constructions, but it has nothing to do with the projection of external arguments into theta-positions. Rather, VoiceP allows the direct object of the active to be moved to Spec TP of the passive, which is why I call it the Realization Theory (as opposed to the Projection Theory).

In the theory of chapter 5, the *by*-phrase occupies Spec vP in the passive. In the short passive, there is a null *pro* which occupies Spec vP. Therefore, the structure of the vP in the passive is as follows:

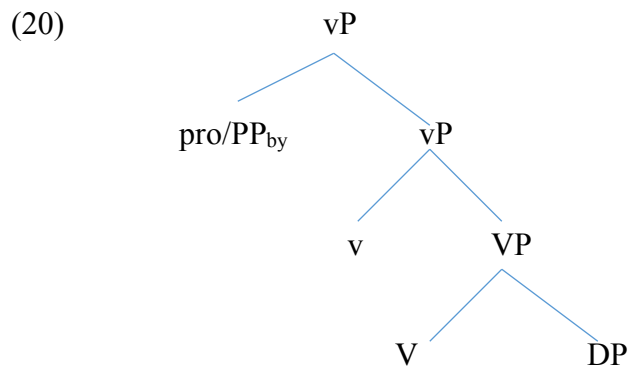

But if this vP were embedded under a finite TP (as the complement of T), there would be no way for the structure to be realized. English does not allow non-nominative subjects so the *by*-phrase could not move to Spec TP. And English is not a pro-drop language, which I assume entails that *pro* cannot appear in Spec TP (although *pro* may appear in other positions, such as Spec vP in the short passive, see chapter 4 for discussion). Furthermore, the object DP could not raise to Spec TP, since vP is a strong phase (because it has a filled specifier). Furthermore, Spec vP is a filled A-position intervening between the object and Spec TP, and so movement of the object to Spec TP would violate Relativized Minimality. See chapter 6 for details.

Therefore, in the theory of Collins 2005a, the reason VoiceP is projected between TP and vP is to allow the object to move to Spec TP, while the subject stays in Spec vP. Collins assumes that the direct object is smuggled over Spec vP. See Collins 2005a and chapter 6 on smuggling.

The advantage of Collins' (2005a) theory is that the projection of arguments in the passive is identical to the projection of arguments in the active. This accounts for Chomsky's (1957) observation that the selectional restrictions in the active and passive are identical (see discussion in chapter 1). It also accounts for the fact that the range of theta-roles found on the external argument in the passive matches those found on the external argument in the active (see chapter 5 for an illustration of this fact from Greek). Lastly, it accounts for the fact that the *by*-phrase in the passive can bind reflexive and reciprocal pronouns, as shown below (from chapter 2):

- (21) a. The packages were sent by the children to each other.  
 b. The pictures were painted by the children for each other.  
 c. The packages were sent by the children to themselves.  
 d. The pictures were painted by the children for themselves.

These properties are hard to account for unless one assumes that the projection of arguments in the passive and active are identical. But if one makes this identity assumption, then the projection of arguments is independent from the passive voice. And by the Terminological Assumption (6), the category projecting external arguments should not be called VoiceP.

I speculate that the primary function of voice (and hence VoiceP) is in the realization of arguments in A-positions (not in the projection of arguments). However, it is important to note that there might be ways that VoiceP operates differently from those outlined in Collins 2005a. Of course, Collins 2005a and this monograph only discuss the passive, so it is unclear what the role of VoiceP is in other voices (e.g., middle, inverse, etc.). What is important is that VoiceP has nothing to do with projecting the external argument, but is rather implicated in how the argumental DPs are realized in A-positions.

A more articulated theory of the syntax of various voice phenomena, and the role of VoiceP in those phenomena (under the Realization Theory) will have to await further research. A restrictive theory would start from the assumption that the arguments in all these constructions are projected in exactly the same way. In other words, if there is an agent (either implicit or overt) in the active, passive, middle, impersonal or inverse, then that agent should be projected the same way in all the constructions. But if the agent is projected in the same way across all the difference voices, then it is a violation of (5) to claim that the agent is projected in Spec VoiceP.

## 7.5 Other Authors

I have argued in this chapter that the external argument is not introduced in Spec VoiceP. Many other authors have come to the same conclusion (see also Newman 2020, Roberts 2019 and Zyman 2017 for views compatible with the one I am arguing for). I give some quotes here.

Merchant (2013:98) in discussing ellipsis involving the passive notes:

- (22) “The crucial element involved in these accounts is the separation of the head that determines voice from the head that determines the external valency of the predicate. There is in fact no conceptual reason these two should go together, and the ellipsis facts argue directly against this assumption.”

Myler and Mali (2021: 3, fn. 3) who otherwise fully adopts Kratzer’s VoiceP framework echo Merchant’s conclusions (see chapter 9 for further discussion of Myler and Mali). Surprisingly, Myler and Mali continue to use the VoiceP notation in their paper.

- (23) “Since the head that introduces external arguments is in some languages clearly separate from and lower than the head that encodes passive-active alternations, the label Voice turns out to be something of a misnomer; see especially Merchant 2008, 2013. Nevertheless we retain the usage here for consistency with the works cited in the final paragraph of this section and with other recent literature on causatives that uses the same framework.”

Based on morpheme order in the Latin passive, Zyman and Kalivoda (2020: 8) explicitly reject Kratzer's use of VoiceP in favor of the Collins/Merchant conception:

- (24) Fifth, the external argument (EA) originates in [Spec,vP] not [Spec,VoiceP] (Collins 2005; Merchant 2013). This is advantageous for three reasons.

Ramchand (2017: 241) notes that the Voice as used by Kratzer does not fit into her framework:

- (25) “But if the Voice head (and its different “flavors” or versions) is supposed to track the kind of externalization that varies with traditional voice morphology, then it certainly cannot be equivalent to the head labeled  $C_{\text{AUSE}}$ , or  $I_{\text{NIT}}$  for that matter. Clearly, VoiceP is not the same thing as the highest head of the Ramchandian decomposition argued for in section 10.2.”

These references show that the Kratzerian analysis of external arguments as being introduced in Spec of VoiceP is far from universally accepted. Furthermore, as Merchant notes, there is no conceptual reason to conflate voice and valency.

## 7.6 Merge-Based Approach

In this monograph, I have argued that the heads that determine argument structure (v, Appl, V) are distinct from the head that determine voice (Voice). I showed that in the passive (long or short) the external argument is projected exactly the same way as in the active. In other words, the projection of the external argument is independent of voice. Therefore, there is no reason to externally Merge the external argument into Spec VoiceP.

Here, I make the stronger claim that the Kratzerian conception of VoiceP introducing the external argument is inconsistent with the Merge-based approach to argument structure.

Kratzerian approaches to the passive have in common that in the active Spec VoiceP is filled, but in the passive it is not. As noted in this monograph, that assumption leads to severe empirical problems, since the implicit argument in the passive in English can bind reflexive pronouns and pronouns in Helke expressions and be modified by secondary predicates.

Not only is the Kratzerian approach problematic empirically, it is also problematic theoretically. Kratzerian approaches are unified in holding that the external argument in the passive is not projected syntactically (although it is existentially bound semantically). But this is just the kind of analysis that the Merge-based theory blocks, since in one case (the active) the external-argument taking property of Voice is satisfied by external Merge, and in the other (the passive) it is not (but rather by some semantic mechanism involving existential closure).

This can be seen by looking carefully at analyses (such as Bruening 2013) that adopt Kratzer's VoiceP. As noted in chapter 5, Bruening allows Spec VoiceP to be filled or empty, while retaining the same semantics. This is a clear violation of the Theta-Criterion, since it means that a theta-position remains unfilled in the passive.

Consider now Pylkkänen’s 2008a analysis of the passive. She postulates that there is a passive Voice<sub>PASS</sub> head that does not project a specifier, and that existentially binds the external argument. The two kinds of Voice heads are given below:

- (26) a.  $[[\text{Voice}]] = \lambda x. \lambda e. \text{agent}(e, x)$   
 b.  $[[\text{Voice}_{\text{PASS}}]] = \lambda e. \exists x. \text{agent}(e, x)$

The structure in (26) is slightly modified from Pylkkänen (2008a: 26):

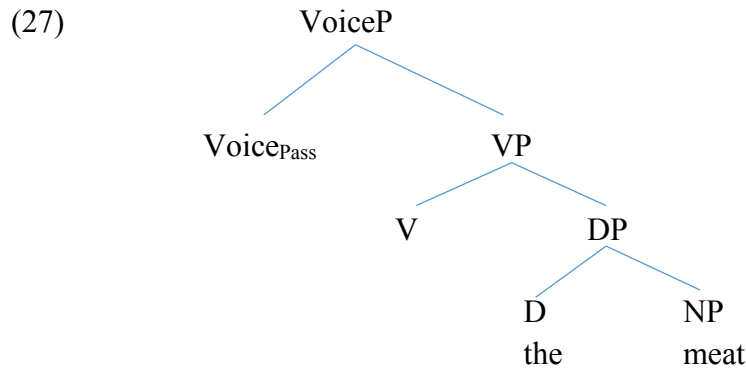

In Pylkkänen’s analysis, Spec Voice<sub>PASS</sub> is never filled, since Voice<sub>PASS</sub> is only used in the passive, not the active. Therefore, the Theta-Criterion does not force a filled specifier in (27). Or to put it in different terms, Voice<sub>PASS</sub> is never an argument introducing head, so it does not need to introduce an argument in (27). Therefore, it seems like Pylkkänen’s analysis (unlike Bruening’s) does not violate either the Argument Criterion or the Theta-Criterion.

However, there is an issue with Pylkkänen’s definition of Voice<sub>PASS</sub>. It seems to combine two completely separate kinds of information: (a) the fact that the external argument is an agent, and (b) the fact that the external argument is existentially closed.

To rule this out, one possibility is to invoke the Principle of Decompositionality (Kayne 2005: 212, see also Bobaljik 2012: 212):

- (28) Principle of Decompositionality  
 UG imposes a maximum of one interpretable syntactic feature per lexical item.

However, it is not entirely clear that (28) rules out (26b), since Voice<sub>PASS</sub> could count as a single interpretable syntactic feature. In general Kayne’s principle suffers from the lack of specification of what a possible interpretable feature is.

What is needed is an additional constraint that minimizes the semantic complexity of each interpretable syntactic feature. A preliminary attempt is the following (thanks to Phillippe Schlenker and Sam Alxatib for discussing this issue with me):

- (29) Principle of Semantic Decompositionality  
 If  $[[X]] = \text{SV1}(\text{SV2})$  (SV1 and SV2 are semantic values)  
 and  $[[Y]] = \text{SV1}$  or  $\text{SV2}$  (where Y is a morpheme in the lexicon)  
 then  $X = [\dots Y \dots]$

The basic idea of this principle is that if X can be decomposed semantically, then X can also be decomposed syntactically. I assume that SV1 and SV2 do not have trivial (identity function) values.

From this point of view, (26b) bundles together the semantic values of the active Voice head, and the existential quantifier *some*, and therefore should be ruled out. The decomposition is shown below:

- (30) a.  $[[\text{Voice}]] = \lambda x. \lambda e. \text{agent}(e, x)$   
 b.  $[[\text{Voice}_{\text{pass}}]] = \lambda e. \exists x. \text{agent}(e, x)$   
 $= [\lambda P. \lambda e. \exists x. P(e, x)]([[ \text{Voice} ]])$

Of course, we can modify Pylkkänen’s analysis in the following way: One head would be active Voice (defined as in (26a)), and the other would existentially bind the external argument (as with the Pass head in Bruening’s analysis). But then if Spec VoiceP is empty, the analysis would violate the Theta-Criterion just as with Bruening’s analysis (see Chapter 4 for discussion).

Another analysis violating (29) is Baker and Vinokurova’s (2009; 531) analysis of agentive nominalizations suffixes such as *-er* in English. They give the following semantic value (the symbol  $\hat{\quad}$  is the nominalization operator):

- (31) *-er*:  $\lambda P \hat{\quad} \lambda x \text{ Gen } e ((P(e) \ \& \ \text{agent}(e, x)))$

Baker and Vinokurova 2009 assume the same semantic value for Voice as in (30a). So (31) contains the semantic value of Voice, and should be ruled out by (29). In other words, (29) forces nominalization and the introduction of external arguments to be done by two different syntactic heads.

## 7.7 Kratzer on Nominalizations

Kratzer (1996: section 5) uses English nominalizations to give additional support for her theory of external arguments: “The discussion of English gerunds confirmed our claim that external arguments are introduced by independent heads that are also responsible for the assignment of accusative Case.”

Consider the following minimal pair:

- (32) a. Maria enjoyed a reading of *Pride and Prejudice*.  
 b. Maria enjoyed reading *Pride and Prejudice*.

According to Kratzer, in (32a) there is no external argument (and hence no control) and no accusative Case. In (32b), there is a controlled external argument and the direct object receives accusative Case. This difference can be explained in terms of the absence of VoiceP in (32a), and the presence of VoiceP in (32b).

The first point to note about this analysis is that it is completely independent of voice. The same exact explanation could have been given in Chomsky 1995’s vP theory, where the external argument is introduced in Spec vP.

But a more serious issue is the generalization that “...in *of<sub>ing</sub>* gerunds, the absence of accusative Case is accompanied by the absence of the verb’s external argument.” Consider the following example:

(33) The constant promoting of himself at conferences is hurting John’s career.

To me, this sounds as good as any other *of<sub>ing</sub>* gerund. But crucially, there is a phonologically null implicit argument (the promoter) that binds the reflexive. Such sentences show that *of<sub>ing</sub>* do not lack external arguments. The fact that control is not possible in (32b) does not have to do with the absence of an external argument, but rather the absence of controlled PRO. Therefore, (33) shows that *of<sub>ing</sub>* nominalizations do not provide any additional evidence for Kratzer’s VoiceP assumptions.

How to represent (33) syntactically, and how to account for the lack of accusative Case are questions I will leave to future research.

## 7.8 Conclusion

In this chapter I compared two conceptions of VoiceP, the Projection Theory and the Realization Theory. I have discussed a number of analyses using Kratzer’s 1996 framework. In each case, they either (a) violate the Terminological Assumption (6), or (b) are empirically inaccurate or incomplete. I have suggested the Realization Theory as an alternative way to think about voice. Lastly, I have argued that the Kratzerian conception of VoiceP introducing the external argument is actually inconsistent with the Merge-based theory of argument structure outlined in chapter 1.

## 8 Dative Alternation

### 8.1 Introduction

A long-standing debate in the syntax literature is the relation between (1a) and (1b), which I call the *Dative Alternation*. This terminology is neutral between an analysis where (1a) is derived from (1b) (Larson 1988, Baker 1997: 91) (*Dative Shift*) or (1b) is derived from (1a) (Bowers 1981: 65) or neither structure is derived from the other (Harley 2002, Harley and Jung 2015, Harley and Miyagawa 2016: 21).

- (1) a. John gave Mary the car. (Double Object Construction)  
b. John gave the car to Mary. (Prepositional Dative)

Evidence that (1b) is derived from a structure underlying (1a) comes from systematic parallels between the dative alternation and the passive.

- (2) a. John wrote the book. (Active)  
b. The book was written by John. (Passive with *by*-Phrase)

In (1a), the indirect object and direct object are unmarked DPs, unaccompanied by prepositions. In (2a), the subject and object are unmarked DPs. (1b) involves a word order reversal, changing the order goal-theme, to the order theme-goal. (2b) also involves a word order reversal, changing the order agent-theme, to the order theme-agent. In (1b) the goal argument is marked by a semantically vacuous preposition *to*. In (2b), the agent argument is marked by a semantically vacuous preposition *by*.

Just like the passive and the active share truth conditions (putting aside the issue of quantifier scope), (1a) and (1b) share truth conditions.

- (3) a. John gave Mary the book iff John gave the book to Mary.  
b. John wrote the book iff the book was written by John.

Lastly, just like in the passive (see Chomsky 1957: 42-43), selectional restrictions are maintained between the orders in (1a) and (1b). In other words, (4c) is a violation of selectional restrictions, since the first object must be the receiver. These selectional restrictions are maintained in the prepositional dative variant in (4d).

- (4) a. I gave John a lovely gift.  
b. I gave a lovely gift to John.  
c. \*I gave a lovely gift John.  
d. \*I gave John to a lovely gift.
- (5) a. Sincerity frightened John.  
b. John was frightened by sincerity.  
c. \*John frightened sincerity.  
d. \*Sincerity was frightened by John.

My conclusions about selectional restrictions and truth conditions are supported by Rappaport Hovav and Levin (2008: 129) who put their thesis as follows: “We challenge the predominant view of the English dative alternation, which takes all alternating verbs to have two meanings: a caused possession meaning realized by the double object variant and a caused motion meaning realized by the *to* variant. Instead, we argue that verbs like *give* and *sell* only have a caused possession meaning, while verbs like *throw* and *send* have both caused motion and caused possession meanings. We show that the caused possession meaning may be realized by both variants. Concomitantly, we argue that verbs like *give*, even in the *to* variant, lack a conceptual path constituent, and instead have a caused possession meaning which can be understood as the bringing about of a ‘have’ relation.”

Given these five parallels, I assume that (1a) is syntactically related to (1b) in a way parallel to the syntactic relation between (2a) and (2b). More specifically, just like the passive is derived by moving the theme over the agent, I propose that the prepositional dative construction is derived by moving the theme over the goal.

In this chapter, I will give further evidence that (1b) is derived from the structure underlying (1a) by movement of the theme over the goal (a conclusion reached on similar grounds by Aoun and Li 1989 and Kitagawa 1994). I point out that such a derivation yields a locality problem (one DP moves over another DP), and suggest a solution to this problem in terms of smuggling (see Collins 2005a, 2005b).

## 8.2 Asymmetries of Asymmetries

Barss and Lasnik 1986 and Larson 1988 show that there are c-command asymmetries in double object constructions and prepositional dative constructions. But there is also an asymmetry between the DOC and the prepositional dative (see also Kitagawa 1994, Harley and Miyagawa 2016, Takano 1998: 824):

- (6) a. John gave every man his paycheck.  
 b. ?John gave his paycheck to every man.
- (7) a. John gave every dog to its owner.  
 b. \*John gave its owner every dog.

(6a) shows that the goal c-commands the theme in a double object construction (since bound variable anaphora is allowed), and (7a) shows that the theme c-commands the goal in a prepositional dative construction. While (6b) is marginal on the bound variable reading, (7b) is completely unacceptable. Assuming that (7b) violates the c-command condition on bound variable anaphora (Barss and Lasnik 1986: 348), the problem is to explain why (6b) does not incur a similarly strong violation.

A contrast similar to the one in (6) and (7) exists for reciprocals (see also Kitagawa 1994, on the marginal status of (8b) see Takano 1998: 824):

- (8) a. I showed the boys each other's pictures.  
 b. ??I showed each other's pictures to the boys.
- (9) a. I showed the students to each other's parents.



- b. \*I showed each other's parents the students.

Backwards anaphora in (8b) with the prepositional dative is considerably better than backwards anaphora in (9b) with the double object construction.

A similar asymmetry between the DOC and the prepositional dative can be seen in quantifier scope (see Breuning 2001, Kitagawa 1994, Aoun and Li 1989 and Harley and Jung 2015 for an extensive discussion):

- (10) a. I gave a student every car.  
b. I gave a car to every student.

In (10a), the only possible interpretation is that there is a single student who receives all the cars. (10a) cannot have the inverse scope interpretation where every car is given to a different student. On the other hand, (10b) admits the inverse scope interpretation, where every student receives a different car.

Burzio (1986: 198-199) points out that there is a c-command constraint on the following use of *each* (although see Safir and Stowell 1987, who coin the term binominal *each*):

- (11) a. We met one girl each.  
b. \*One girl each met us.

In (11a), the plural subject c-commands the structure [two girls each]. But in (11b), the plural object does not c-command [two girls each], and the sentence is unacceptable.

Given this constraint, consider the following data ((13) is from Burzio 1986: 199):

- (12) a. John assigned [the visitors] one interpreter each.  
b. John gave [the kids] one present each.  
c. John sent [the students] one letter each.
- (13) a. (?) John assigned one interpreter each<sub>1</sub> to [the visitors]<sub>1</sub>  
b. ?John gave one present each<sub>1</sub> to [the kids]<sub>1</sub>  
c. ?John sent one letter each<sub>1</sub> to [the students]<sub>1</sub>
- (14) a. \*John assigned one visitor each the interpreters.  
b. \*John gave one child each the toy cars.  
c. \*John sent one student each the letters.
- (15) a. John assigned the interpreters to one visitor each.  
b. John gave the toy cars to one child each.  
c. John sent the letters to one student each.

There is a clear contrast between (13) and (14), even though in both cases [DP each] precedes its antecedent.

As argued by Kitagawa 1994, Aoun and Li 1989 and Takano 1998, these kinds of asymmetries between DOCs and the prepositional dative can be explained if the prepositional dative is derived by movement of the theme over the goal.

Focusing on the quantifier data in (6) and (7), consider first the relevant condition from Barss and Lasnik 1986:

- (16) "...in order for a pronoun to be related to a quantificational NP (QNP) as a variable, it must be in the domain of the QNP at S-Structure." (pg. 348)

The relative acceptability of (6b) can be accounted for if (6b) is derived by A-movement of the theme over the goal. Under that assumption, the quantifier phrase c-commands one of the occurrences of *his paycheck*, and therefore c-commands the pronoun. This derivation is sketched below:

- (17) John gave his paycheck to every man <his paycheck>

Supporting evidence for this analysis is given by the following contrast involving A-movement:

- (18) a. His<sub>1</sub> mother seems to [every boy]<sub>1</sub> to be nice.  
b. \*His<sub>1</sub> mother told [every boy]<sub>1</sub> to be nice.

(18a) involving raising is acceptable with a bound variable interpretation. (18b) is unacceptable. Since (18a) involves A-movement, *every boy* c-commands one occurrence of the pronoun (on a similar case involving psych-verbs, see Belletti and Rizzi 2012: 134).

I assume that the binding theory data, quantifier scope data and binominal *each* data can be explained in a similar way (see Kitagawa 1994, Aoun and Li 1989). On reconstruction effects in A-movement more generally, see Sportiche 2017a, Lebeaux 2009 and Barss 2001.

However, a theoretical problem arises in the putative derivation for (6b) illustrated in (17). Such a derivation should violate Relativized Minimality (see Rizzi 1990) or the Minimal Link Condition (see Chomsky 1995) since the movement of the theme DP crosses over the goal KP. To overcome this problem, I propose a smuggling analysis, parallel to the smuggling analysis of the passive discussed in chapter 6.

### 8.3 Structure of DOCs

For background, I assume that the double object constructions should be analyzed in terms VP shells (see Larson 1988, Pylkkänen 2008a), where the VP shells are vP, ApplP and VP and perhaps others (see the introduction for references). In particular, I assume v takes an ApplP complement, and Appl takes a VP complement.

I do not follow Pylkkänen (2008a) who analyzes English as having a low applicative. Pylkkänen argues that the semantics of the low applicative differ from the semantics of the high applicative (pg. 14): "A high applicative head is very much like the external-argument-introducing head: it simply adds another participant to the event described by the verb. In contrast, low applied arguments bear no semantic relation to the verb whatsoever; they only bear a transfer-of-possession relation to the direct object."

Although I will not discuss Pylkkänen's approach in detail (see Larson 2010, 2014 for critical discussion), I briefly note here it is possible to obtain the semantics attributed to the low

applicative syntax (pg. 18) from a high applicative syntax (pg. 12). It is only necessary to define high applicative lexical entry as follows:

$$(19) \quad \llbracket \text{APPL} \rrbracket = \lambda P. \lambda x. \lambda e. [P(e) \wedge \text{to-the-possession}(e, \text{Theme}(e), x)]$$

In this semantic value,  $\text{Theme}(e)$  is the function yielding the unique theme argument of  $e$ . In other words, when *Appl* is added to the VP, it adds a goal argument and says that the goal argument is related to the theme of the event by the *to-the-possession* relation.

Since Pylkkänen admits that the high applicative head comes in several semantic flavors (e.g., instrumental, benefactive, malefactive, pg. 17), I propose that (19) is just one more flavor. This new definition of the semantic value of the high applicative head also captures some of the other properties listed by Pylkkänen (pg. 18). Since *Appl* introduces the *to-the-possession* relation, V must have a theme argument. Pylkkänen also claims that high applicatives and low applicatives differ with respect to secondary predication. For brevity's sake, I do not pursue that issue here (see Harley and Jung 2015 for a recent discussion of depictives and DOCs).

A partial underlying structure of (1a) is given below (I leave out the representation of the movement of the V to *Appl* and the movement of *Appl* to v):

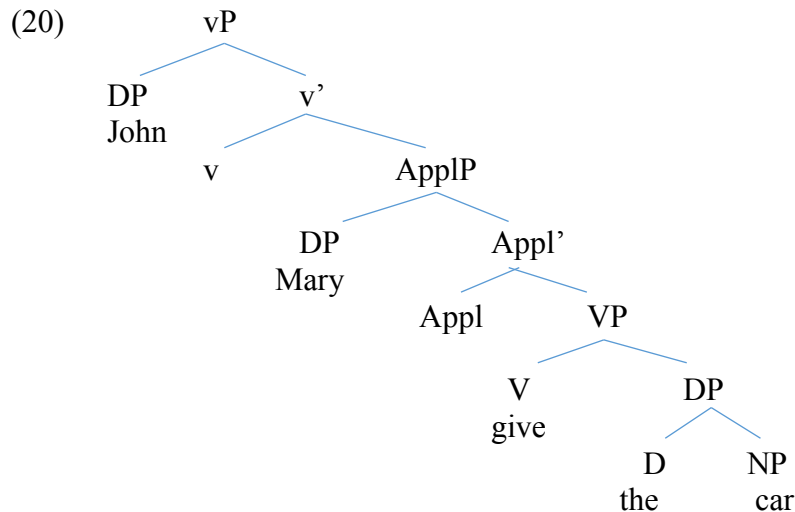

## 8.4 Analysis

In Collins 2020, I analyzed the dative preposition *to* as the head of VoiceP. However, in this chapter, I will analyze *to*-phrases as KPs, just as I did with *by*-phrases in chapter 5. If the *to*-phrase is a KP, the question is what determines its syntactic distribution. For example, why can't the *to*-phrase appear in Spec vP in the passive? I will assume that on the KP analysis, there must be some constraint that forces the dative *to*-phrase to appear in Spec ApplP, instead of any other position. The generalization is the following:

$$(21) \quad [\text{to DP}] \text{ appears in Spec ApplP (and no other position).}$$

I put aside the relation between the dative *to* and the directional *to* found in sentences like “I went to the store.” I assume that the distribution of the directional *to* does not fall under (21). This issue is analogous to the fact that passive *by* is homophonous to a locative *by*.

I propose that dative *to* has a c-selectional feature which constrains it to appear in Spec ApplP. In particular, I propose the following:

(22) *to* has c-selectional feature [ $\_$ ApplP]

The technical framework assumed in this account is that of Collins and Stabler (2016: 62): “We call the features involved in triggering Merge ‘trigger features’. We assume that such features are to be identified with subcategorization features, EPP features and OP features for movement to Spec CP...”

The underlying structure of the prepositional dative is given below (see also Hallman 2021 for a related analysis):

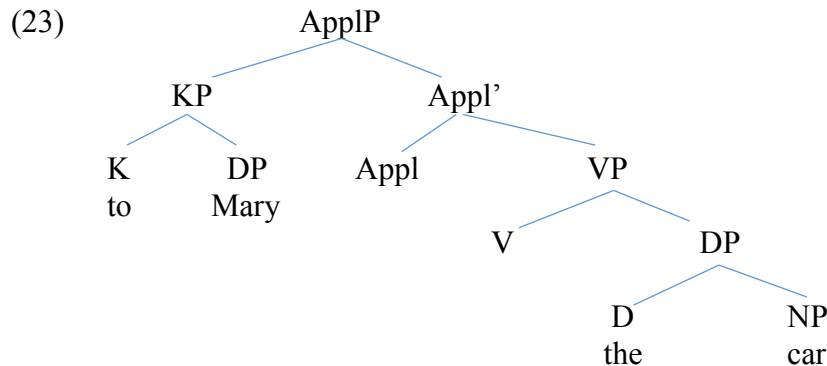

Consider how the Theta-Criterion is satisfied by (23). Because of structure (20), we concluded that Spec ApplP is a theta-position (because an argument DP is externally merged there). Therefore, in (23) Spec ApplP must also be a theta-position since we are assuming there are not different flavors of Appl. Rather, the same Appl is used in both the double object construction and the prepositional dative, just exactly like the same little *v* is used in both the active and the passive. But [ $\text{KP}$  to Mary] is an argument, so merging it in Spec ApplP satisfies the Theta-Criterion.

Compare this structure to the structure of the *v*P in the passive (e.g., *the book was written by John*):

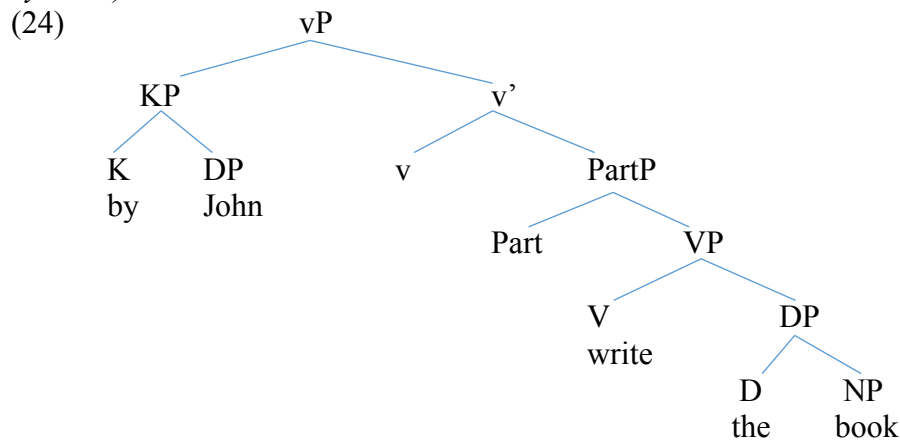

Given this background, I propose that the dative alternation should be analyzed in terms of smuggling, just like the passive (see Collins 2005a, Collins 2005b, and also chapter 6). I propose that (1b) is derived from (1a) by VP movement smuggling the theme past the goal. In particular, there is a VoiceP projection whose specifier the VP moves into. Technically, VP satisfies an EPP feature of Voice. I will refer to this Voice head involved in the dative alternation as *inner Voice*, to distinguish it from the one used in the passive, which I will refer to as *outer Voice*.

Therefore, there are at least two Voice heads in English, with slightly different properties:

- (25) a. outer Voice:
- i. It is not an argument introducing head.
  - ii. Takes vP as a complement.
  - iii. PartP moves to its specifier.
  - iv. It is semantically vacuous.
- b. inner Voice:
- i. It is not an argument introducing head.
  - ii. Takes ApplP as a complement.
  - iii. VP moves to its specifier.
  - iv. It is semantically vacuous.

It is possible that these two Voice heads (inner Voice and outer Voice) are just two instantiations of the same general head, appearing in two different positions. When Voice is merged high, we get outer Voice. If Voice is merged low, we get inner Voice. But syntactically, there is just one Voice head. Such an analysis predicts that there are correlations between the passive and dative alternation cross-linguistically (because they are triggered by the same Voice head). I have not looked into this prediction.

The derivation of the prepositional dative construction is given below:

- (26) John gave the car to Mary.
- a.  $[_{AppIP} KP [_{AppI'} Appl [_{VP} V [_{DP} \text{the car}]]]] \rightarrow \text{Merge Voice}$
  - b.  $[_{VoiceP} \text{Voice} [_{AppIP} KP [_{AppI'} Appl [_{VP} V [_{DP} \text{the car}]]]]] \rightarrow \text{Move VP}$
  - c.  $[[_{VP} V [_{DP} \text{the car}]] [_{Voice'} \text{Voice} [_{AppIP} KP [_{AppI'} Appl <VP>]]]]$

A problem with the derivation in (26) is that it gives the wrong c-command relations between the theme and goal. As discussed by Larson (1988) the theme DP c-commands the goal DP in prepositional dative constructions.

- (27) I showed the students to each other's teachers

In (27), the DP *the students* c-commands the DP *each other*, and hence is able to bind it. However, in (26c), because of the presence of the fronted VP constituent, the theme does not actually c-command the goal (the theme DP is dominated by VP, which does not dominate the goal DP). Such considerations suggest that the theme DP in (26c) must undergo one subsequent A-movement out of the VP. I assume that Spec AgroP (object agreement phrase) is the relevant position. For analyses involving raising to object, see Postal 1974. For vP internal functional projections, see Collins 2003, Collins and Thráinsson 1996 and Baker and Collins 2006.

Putting all these steps together yields the following structure (I leave out the movement of the verb to Agro, and Agro to v):

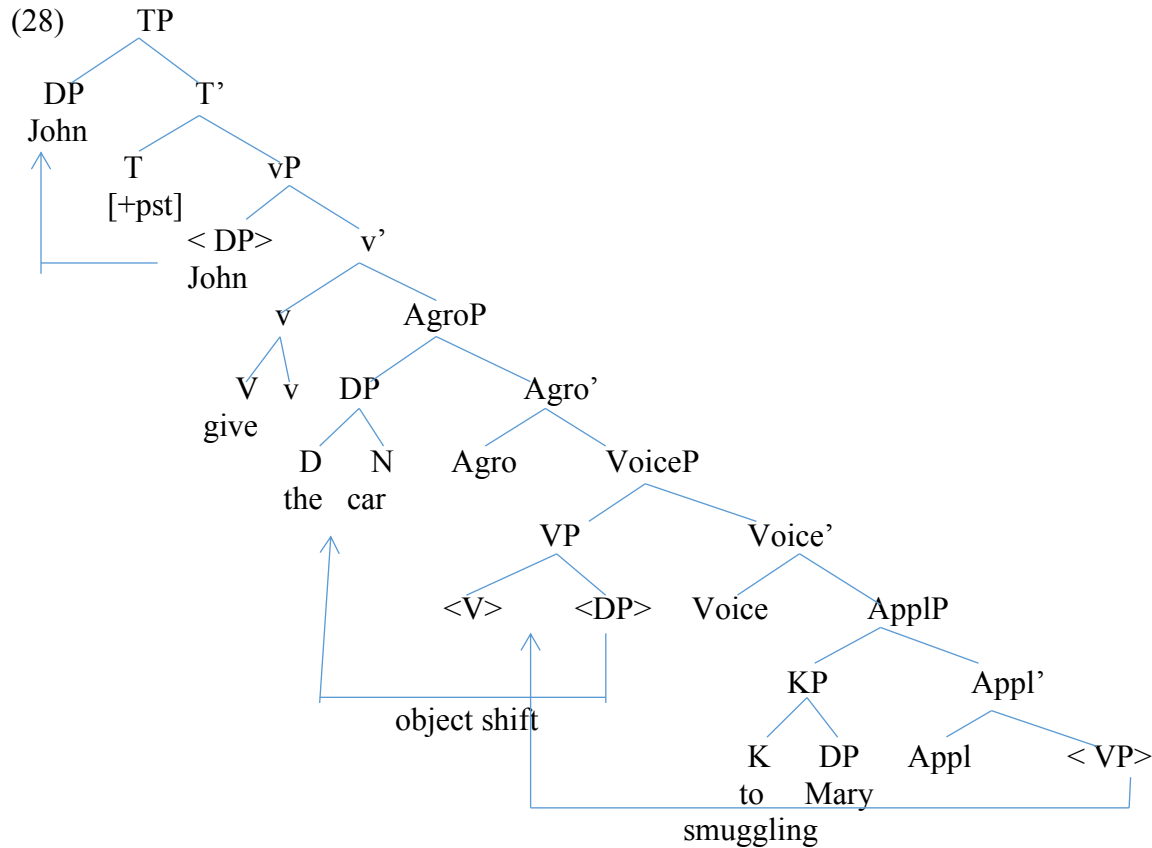

Let's verify that this structure meets all the requirements outlined earlier.

First, since the prepositional dative is derived from a structure underlying the DOC, we can account for the fact that they share identical selectional restrictions (and truth conditions).

Second, since VP is moved over the KP *to Mary* in Spec ApplP, there is no violation of Relativized Minimality or the MLC. The theme DP does not directly move over the goal KP, rather the theme DP is smuggled over the goal KP by VP movement.

Third, the DP *the car* c-commands the DP *to Mary* (after raising to Spec Agro). Hence the standard c-command facts will hold (see (27)).

Fourth, since the theme DP *the car* originates in a position lower than the goal DP *to Mary*, we can account for the acceptability of the various reconstruction effects.

The analysis in (28) is similar to the analysis of *faire* causatives given in Kayne 2005: chapter 5. And in fact, the parallelism between my analysis and Kayne's analysis strongly supports the assumption I made earlier that the prepositional dative should be the derived structure (and not the underlying structure) in the dative alternation. In the *faire* causative of a transitive verb, the external argument of the causativized verb bears a dative preposition *à*. But the embedded clause corresponds to an underlying SVO structure (with no dative preposition).

## 8.5 Hallman 2015

Hallman 2015 discusses the use of purpose clauses in double object constructions. He uses this data to motivate an analysis very similar to mine, where the prepositional dative construction is derived from an underlying double object construction. In this section, I will review his data.

First, consider the following examples of purpose clauses in double object constructions (see Hallman 2015: 392):

- (29) a. Mary gave John a puppy to play with.  
 b. Mary sent John a manuscript to read.  
 c. Mary assigned John a job to do.  
 d. Mary lent John a bicycle to run some errands with.  
 e. Mary offered John her apartment to stay in.

Hallman (2015: 392) analyses the purpose clause in these examples as involving PRO controlled by the first object and an empty operator coindexed with the second object:

- (30) Mary gave John<sub>1</sub> a puppy<sub>2</sub> [<sub>CP</sub> Op<sub>2</sub> [<sub>PRO</sub><sub>1</sub> to play with t<sub>2</sub>]]

The structure of the purpose clause in (29a) [to play with] is given in (31). Following Hallman, I will assume that the subject of the purpose clause is PRO, but there is also an empty operator in Spec CP.

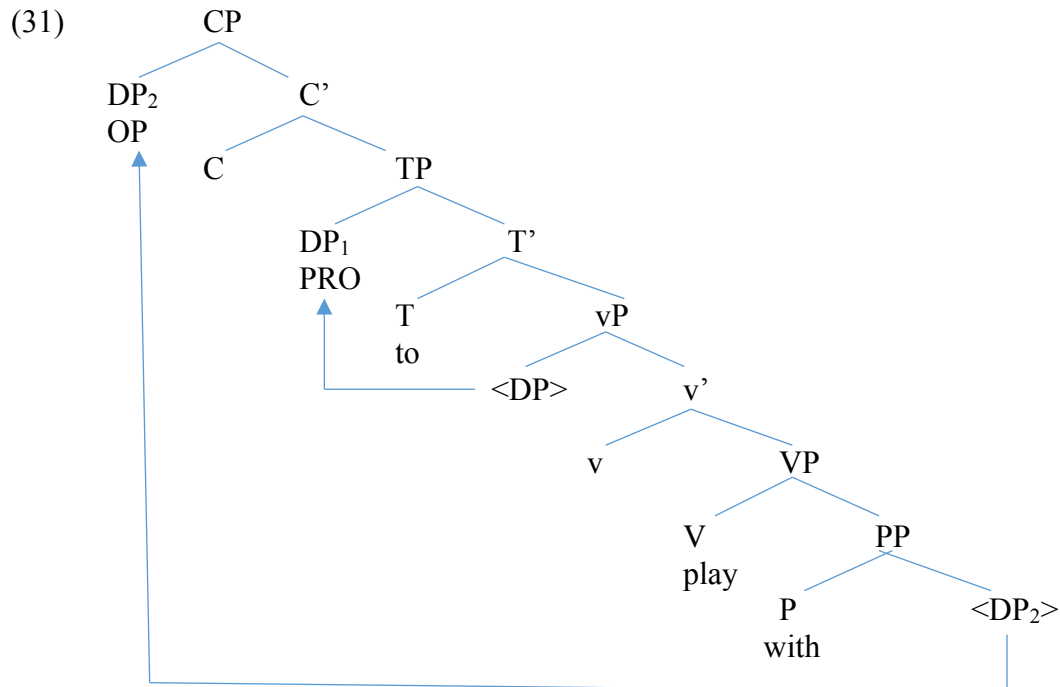

Hallman assumes that PRO is c-commanded by its antecedent (pg. 399). He claims that the purpose clause with an empty operator in Spec CP is a derived predicate (pg. 392), although he does not clearly state what the structural conditions on predication are.

The prepositional dative shows the same control possibilities as the double object construction in (29):

- (32) a. Mary gave a puppy to John to play with.  
b. Mary sent a manuscript to John to read.  
c. Mary assigned a job to John to do.  
d. Mary lent a bicycle to John to run some errands with.  
e. Mary offered her apartment to John to stay in.

Locative constructions that select a DP+PP frame do not accept such purpose clauses:

- (33) a. \*Mary put the child<sub>2</sub> on the horse<sub>1</sub> [ PRO<sub>1</sub> to carry e<sub>2</sub>]  
b. \*Mary led the horse<sub>2</sub> to John<sub>1</sub> [ PRO to feed e<sub>2</sub>]  
c. \*Mary poured honey<sub>2</sub> on her little brother<sub>1</sub> [ PRO<sub>1</sub> to lick off e<sub>2</sub>]  
d. \*Mary immersed the cloth<sub>2</sub> in oil<sub>1</sub> [ PRO<sub>1</sub> to permeate e<sub>2</sub>]  
e. \*Mary placed the planting pots<sub>2</sub> under the tomato vines<sub>1</sub> [ PRO<sub>1</sub> to grow over e<sub>2</sub>]

Hallman (2015: 399) explains this data as follows:

- (34) “Binding of PRO in the purpose clause by the location argument in locative constructions is impossible... That argument does not c-command the PRO subject of the purpose clause when the purpose clause is predicated of the theme, since the theme is hierarchically higher in the structure than the location argument.”

But then the structure of the prepositional data cannot be like the structure of the locative construction, since the *to*-phrase can control PRO, but the locative cannot. Rather, the prepositional dative construction has the same underlying structure as the double object construction, accounting for the parallels in control. Hallman (2015: 399) puts it as follows:

- (35) “The fact that the subject PRO in the purpose clause may be bound by the possessor in the matrix clause [C.C. in the prepositional dative construction] indicates that the possessor c-commands the purpose clause PRO, and therefore the purpose clause itself.”

Hallman’s data is parallel to the reflexive binding data that I gave in chapter 5:

- (36) a. *by*-phrase (but not DP in adjunct) can bind a reflexive pronoun.  
b. *to*-phrase (but not DP in locative phrase) can control PRO.

## 8.6 Conclusion

In this chapter, I have argued that the dative alternation should be given an analysis parallel to that of the passive construction. I started by outlining five parallels between the passive and the dative alternation. Then I showed how the dative alternation gives rise to asymmetries that are only explicable if the theme moves over the goal in the prepositional dative construction.

Given this background, I gave an analysis of the dative alternation parallel to that of the passive. In the prepositional dative construction, a KP is externally merged into Spec ApplP, and



then the VP moves over Spec ApplP into the specifier of an inner Voice head, smuggling the theme over the goal.

Lastly, I showed how my analysis is able to account for Hallman's data concerning control of PRO in purpose clauses in the dative alternation versus locatives.

## 9 On the Tension with Formal Semantics

In this chapter I will discuss a tension that arises between an approach to argument structure based on the syntactic operation Merge and an approach to argument structure based on the compositional mechanisms of formal semantics. First, I discuss Heim and Kratzer 1998, who argue against the Theta-Criterion. Then I will discuss a range of other examples from the literature presenting similar issues. Lastly, I will summarize the issues.

### 9.1 Heim and Kratzer 1998

As noted in the introduction, there are people who deny the existence of the Theta-Criterion. For example, Bruening (2013: 23) gives the following statement:

- (1) “Because there are no syntactic thematic roles in this system, there is also no  $\theta$ -Criterion. Elements will either combine semantically, or they will not. If a head is a function that calls for an argument and an argument of the appropriate type combines with it, the semantics will be well-formed. If a predicate calls for an argument and no argument combines with it, it will be ill-formed. If there is an argument that does not serve as the argument of any predicate in the semantics, the result will also be ill-formed. All the work of the  $\theta$ -Criterion is done by the semantics.”

A similar sentiment can be found in Myler and Mali (2021: 3):

- (2) “Also, the Theta Criterion has no status in this conception: all that is required is that the structure compose successfully in the semantics (Full Interpretation; see also Baker 1997: 121-122, Heim and Kratzer 1998: 53-58).”

The issue of the Theta-Criterion and formal semantics was first discussed in Heim and Kratzer (1998: 51). I give the extended quote below:

- (3) “Suppose we have a predicate  $\alpha$  with one  $\theta$ -role to assign. In our terms, suppose that  $[[\alpha]]$  is of the type  $\langle e, t \rangle$ . According to the  $\theta$ -Criterion,  $\alpha$  must appear in the vicinity of something that receives its  $\theta$ -role. That means  $\alpha$  has to have a sister node with a meaning of type  $e$ . According to our Interpretability principle, on the other hand, a sister node of type  $e$  is not strictly required. It would provide one suitable environment for  $\alpha$ , but not the only kind. Imagine instead that  $\alpha$  has a sister node whose meaning is *a function with domain*  $D_{\langle e, t \rangle}$ . (For instance, it might be of type  $\langle \langle e, t \rangle, e \rangle$ .) In that case, the next higher node could be interpreted as applying this sister’s meaning to  $[[\alpha]]$ . So we could have an interpretable structure which does not contain an argument for  $\alpha$ !  $\alpha$  would not be assigning its  $\theta$ -role to any phrase, in violation of the  $\theta$ -Criterion. Yet Interpretability would be fulfilled, in virtue of  $\alpha$  being a suitable argument for its sister node.”

In this paragraph, they are explicitly arguing against the Theta-Criterion in favor a weaker Principle of Interpretability, which is stated below (Heim and Kratzer 1998: 49):

- (4) Principle of Interpretability

All nodes in a phrase structure tree must be in the domain of the interpretation function  $\llbracket \cdot \rrbracket$ .

Basically, the interpretation function divides into several cases depending on the structure involved: Terminal Nodes, Non-Branching Node, Functional Application. What the Principle of Interpretability says is that all nodes must fall under one of these cases.

Crucially, Heim and Kratzer (1998: 53) note that it is an empirical issue whether or not the Theta-Criterion exists: “These two arguments against the  $\theta$ -criterion are not beyond question, of course. They are only as good as the syntactic and semantic analyses we have sketched.”

Heim and Kratzer (1998: 51-53) present two empirical arguments against the Theta-Criterion. I discuss these examples at length to bring out the relevant issues. The first issue concerns nouns as predicates:

(5) “In the following chapter, we will propose that common nouns like ‘barn’ are 1-place predicates (type  $\langle e, t \rangle$ ). In other words, they have a  $\theta$ -role to assign, and thus the  $\theta$ -Criterion requires the presence of an argument. In certain examples (predicative uses), this is unproblematic:

(6) This is a barn.

The required argument here is the subject NP ‘this’. (6) is true if and only if the object referred to by ‘this’ has the property of being a barn. But consider the following sentence:

(7) The barn burned down.

(7) contains no phrase that receives the  $\theta$ -role of ‘barn’. It thus seems to violate the  $\theta$ -Criterion. Yet it is perfectly fine, and we will see below how it can be interpreted by assigning ‘the’ a meaning of type  $\langle \langle e, t \rangle, e \rangle$  suitable to take  $\llbracket \text{barn} \rrbracket$  as an argument. So this is the sort of case that we have been looking for. The Interpretability Principle and the  $\theta$ -Criterion make different predictions here, and if the analysis we will give for (7) is on the right track, then the empirical facts favor the former.”

From the point of view of the Theta-Criterion we have three choices here: (a) The Theta-Criterion is wrong, and should be abandoned in favor of weaker principles like the Interpretability Principle. (b) The Theta-Criterion is right, but somehow it does not apply to *barn*. That is, somehow *barn* does not require a syntactically present argument as its sister in the expression *the barn*. (c) The Theta-Criterion is right, but the analysis of the *barn* in the quote is wrong and there is a syntactically represented implicit argument of *barn* in sentences such as “The barn burned down.”

Curiously, Heim and Kratzer choose option (c) later on in their book. Based on issues having to do with the interpretation of quantifier phrases internal to DPs, they state (pg. 229): “Once we entertain a subject position not only in VP but also in PP, it is natural to do the same for the remaining categories that were traditionally analyzed as 1-place predicates: namely, APs and NPs.”

Consider the following example:

(6) No owner of an espresso machine drinks tea.

The question is how to interpret the quantifier phrase *an espresso machine*, which takes scope internal to the subject DP. They propose the following structure:

(7) [NP PRO [N' owner [PP of an espresso machine]]]

In this structure, the whole NP is of type *t*, and so the DP *an espresso machine* can undergo QR and adjoin to it.

But once one allows this kind of syntactic structure for *owner of an espresso machine*, it is unclear what would block it for *barn* in (5). In other words, I propose *the barn* has the following structure consistent with the Theta-Criterion (for a similar conclusion, see Koopman 2003, 2005):

(8) [DP the [NP ec barn]] (ec = empty category)

Whether *ec* should be the same as *pro*, *PRO* or a copy of some moved element is unclear. But I assume that Spec NP is a theta-position. And so by the Theta-Criterion, the Theta-Position associated with *barn* is filled in (8).

The second argument in Heim and Kratzer 1998 is based on VP coordination, which they represent as follows (I number the VPs for exposition purposes):

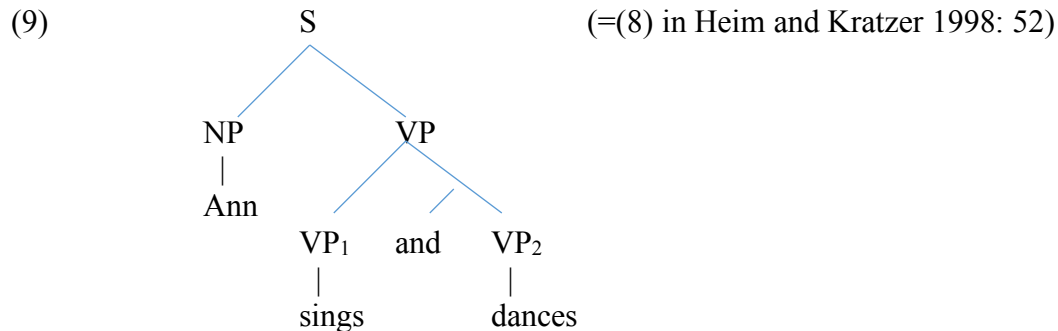

Heim and Kratzer (1998: 52) state the following: “What interests us here is that this is another interpretable structure which seems to violate the  $\theta$ -Criterion, in that there are not enough arguments to go around for all the  $\theta$ -roles that need to be assigned in (9). ‘Sing’ and ‘dance’ each have a  $\theta$ -role to assign, but only one potential argument (the NP ‘Ann’) is present. Once more, we tentatively conclude that the weaker requirements imposed by our Interpretability Principle make the better empirical predictions.”

But clearly (8) is not a well-formed syntactic structure, since it does not comply with the VP-Internal Subject Hypothesis (discussed in Heim and Kratzer, section 8.4). Suppose that the subject *Ann* raises by ATB (Across-the-Board) movement from Spec VP<sub>1</sub> and Spec VP<sub>2</sub> to Spec TP. The structure is illustrated below:

(10) [S Ann [VP [VP <Ann> sings] and [VP <Ann> dances]]]

Consider the resulting structure from the stand-point of the Theta-Criterion, repeated below (see chapter 1 for discussion of different versions of the Theta-Criterion):

(11) Theta-Criterion (Chomsky 1986: 97)

Each argument  $\alpha$  appears in a chain containing a unique visible theta-position P, and each theta-position P is visible in a chain containing a unique argument  $\alpha$ .

An important issue is how to interpret the notion of chain formed by ATB movement. Is there one chain or are there two chains? Let us assume for the sake of argument that there are two chains (understood as a sequence of positions, see Collins and Stabler 2016 for a formalization of the notion of chain):

- (12) a. <Spec TP, Spec VP<sub>1</sub>>  
b. <Spec TP, SpecVP<sub>2</sub>>

As for the first half of the Theta-Criterion, *Ann* is in a chain containing a unique theta-position (e.g., chain (12a)). As for the second half of the Theta-Criterion, each theta-position P (Spec VP<sub>1</sub> and Spec VP<sub>2</sub>) is visible in a chain containing a unique argument  $\alpha$ , that is, *Ann*.

In summary, neither of Heim and Kratzer's arguments against the Theta-Criterion is particularly compelling. For the argument based on nouns like *barn*, they change their analysis later in the book. For the argument based on VP coordination, they propose an erroneous syntax for VPs (without the VP Internal Subject Hypothesis) to make their point.

## 9.2 Jacobson 2014

The function composition and type shifting mechanisms of Jacobson (2014) allow violations of the Theta-Criterion. In a discussion of relative clauses, Jacobson (2014: 229) notes:

- (13) “The Direct Compositional version sketched here – which makes no use of traces and no use of indices or assignments – ends up with the same result. Notice that the function composing the lifted (GQ)  $\llbracket$ Martha $\rrbracket$  with  $\llbracket$ refinish $\rrbracket$  directly results in an expression *Martha refinished* which denotes the set of things that Martha refinished... There is no need to assume *refinish* combines in the syntax with an actual NP (such as a trace) and no reason to assume  $\llbracket$ refinish $\rrbracket$  – of type  $\langle e, \langle e, t \rangle \rangle$  – needs to actually find an argument of type *e* to combine with. Indeed, it does not find such an argument, but is composed with the GQ subject.”

The combination of  $\llbracket$ Martha $\rrbracket$  with  $\llbracket$ refinish $\rrbracket$  is made possible by the function composition rules, summarized as follows (see pages 221-222):

- (14) “Take a function *f* from A to B and a function *g* from B to C (any two of those sets could happen to be the same). Then the two functions can be composed into a new function notated as *g*◦*f* which is a function from A to C, where for any *x* in A, *g*◦*f*(*x*) = *g*(*f*(*x*)).”

Jacobson's approach to argument structure is not consistent with the Merge-based approach. For Jacobson, *refinish* is of type  $\langle e, \langle e, t \rangle \rangle$ , but never combines with an internal argument. The claim that “There is no need to assume *refinish* combines in the syntax with an

actual NP (such as a trace)...” contradicts the Theta-Criterion, which imposes exactly such a requirement.

Empirically, it looks like Jacobson is allowing dependencies to be formed using the powerful devices of formal semantics, and making syntactic movement unnecessary (internal Merge). It is unclear how under this approach traditional arguments for movement (such as island effects, or morphological reflexes of movement) would be accounted for (see Jacobson 2014: 232 for a short remark on island constraints). This issue was recognized by Keine and Bhatt (2016: 1467, fn. 16), in a paper otherwise devoted to arguing for function composition as a semantic rule of interpretation: “Function composition is a powerful device. If left unrestricted, it would allow for the formation of syntactic dependencies across island boundaries.”

Another line of investigation would be to probe whether there are tests for a syntactically projected direct object in the relative clause *Martha refinished*. There are a very large number of such diagnostics (e.g., anaphora, secondary predicates, control as well as many others). Jacobson’s analysis makes the counter-intuitive prediction that all of these will come up negative when looking at the direct object position of *Martha refinished*. Or alternatively, if the tests came up positive, it would need to be argued that all of these tests have to be recast semantically (that is, not diagnosing a syntactically projected direct object, but rather a variable in the semantic value of the relative clause).

For example, consider the relative clause construction: *the fish that Martha ate*. We can ask whether or not there is a syntactically projected direct object or not. But a secondary predicate can appear there: *the fish that Martha ate raw*. On the assumption that a secondary predicate requires a syntactically projected DP to be predicated of, the fact that a depictive secondary predicate can be predicated of the missing object argues against Jacobson’s claim that “There is no need to assume *refinish* combines in the syntax with an actual NP (such as a trace)...”. Of course, Jacobson could try to give a purely semantic theory of the licensing of secondary predicates, but the similar semantic theories would have to be given for reflexive binding and control.

### 9.3 Pylkkänen 2008

Pylkkänen 2008a gives arguments for high versus low applicatives. High applicatives involve an applicative head merged with VP. Low applicatives involve the verb merging with the ApplP. I will not review her arguments here for this distinction (for some discussion see chapter 8). Nor will I discuss the structure of high applicatives. The structure of a low applicative (as in English double object constructions) is given below

(15) Structure of Low Applicative

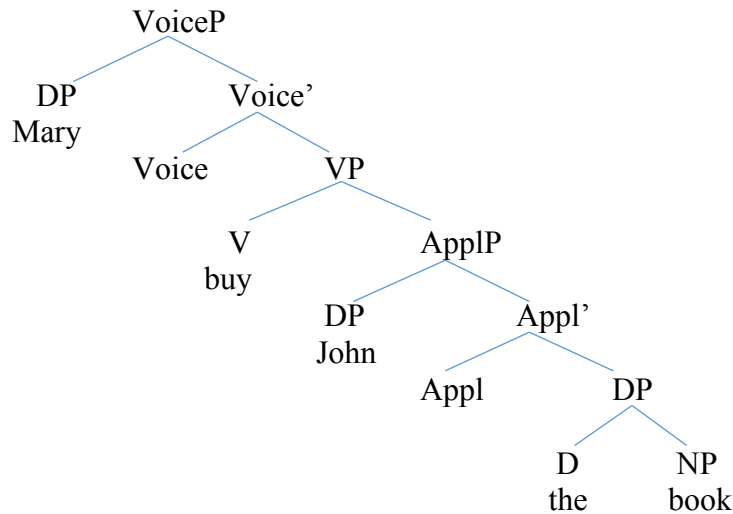

The issue that this tree raises is how to interpret the verb *buy*, for which Pylkkänen (2008a: 18) gives the following semantic values:

- (16) a.  $\llbracket \text{Voice} \rrbracket = \lambda x. \lambda e. \text{agent}(e, x)$   
 b.  $\llbracket \text{buy} \rrbracket = \lambda x. \lambda e. \text{buying}(e) \ \& \ \text{theme}(e, x)$

The problem is that the sister of *buy* in (15) is not *the book*, but is rather the whole ApplP. Pylkkänen (2008a: 18) resolves this issue by giving Appl the following semantic value:

- (17)  $\llbracket \text{Appl} \rrbracket = \lambda x. \lambda y. \lambda f_{\langle e, st \rangle} \lambda e. f(e, x) \ \& \ \text{theme}(e, x) \ \& \ \text{to-the-possession}(x, y)$

Given these semantic values, we have:

- (18)  $\llbracket \text{VP} \rrbracket = \lambda e. \text{buying}(e, x) \ \& \ \text{theme}(e, \text{the book}) \ \& \ \text{to-the-possession}(\text{the book}, \text{John})$

But note that the predicate *buy* does not combine with its DP argument by Merge, but rather it combines with ApplP (and so the semantic value of *buy* and the semantic value of DP are combined indirectly), and so this is a violation of the Merged-based theory of argument structure. More concretely, the complement position of *buy* is a Theta-Position, but it is not filled by an argument in (15).

Note also that Pylkkänen's (2008a) approach to the semantic value of ApplP is similar to Bruening's (2013: 25) approach to the semantic value of *by* (see chapter 5). Both *by* and Appl take functions as arguments, which are then applied to arguments:

- (19)  $\llbracket \text{by} \rrbracket = \lambda x \lambda f_{\langle e, st \rangle} \lambda e. f(e, x)$

As we have discussed in chapter 5, Bruening’s analysis is ruled out for very similar reasons. In particular, in Bruening’s analysis, the *by*-phrase is adjoined to VoiceP, leaving Spec VoiceP unprojected (and giving rise to a Theta-Criterion violation).

Another argument against (17) is the following. If such complex semantic values are allowed, nothing prevents one from defining Appl as follows:

$$(20) \quad \llbracket \text{Appl} \rrbracket = \lambda x. \lambda y. \lambda f_{\langle e, st \rangle}. \lambda g_{\langle e, st \rangle}. \lambda z. \lambda e. \\ g(e, z) \ \& \ f(e, x) \ \& \ \text{theme}(e, x) \ \& \ \text{to-the-possession}(x, y)$$

Such a semantic value yields the same results as the semantic value for Appl that Pylkkänen gave,  $\lambda g$  introduces the agent function (found in Voice), and  $\lambda z$  introduces the agent. But given (20), it is possible to define numerous other semantic values that do not seem to exist in the world’s languages:

$$(21) \quad \llbracket \text{Appl} \rrbracket = \lambda x. \lambda y. \lambda f_{\langle e, st \rangle}. \lambda g_{\langle e, st \rangle}. \lambda z. \lambda e. \\ g(e, z) \ \& \ f(e, x) \ \& \ \text{theme}(e, x) \ \& \ \text{to-the-possession}(z, y)$$

Applied to (15), this yields the interpretation:

(22) Mary bought the book and Mary is to-the-possession of John.

In fact, one can also get a kind of inverse reading:

$$(23) \quad \llbracket \text{Appl} \rrbracket = \lambda x. \lambda y. \lambda f_{\langle e, st \rangle}. \lambda g_{\langle e, st \rangle}. \lambda z. \lambda e. \\ g(e, y) \ \& \ f(e, x) \ \& \ \text{theme}(e, x) \ \& \ \text{to-the-possession}(x, z)$$

Applied to (15), this yields the inverse interpretation:

(24) John bought Mary the book.

In fact, adopting the kind of technology that Pylkkänen uses implies that there are no constraints at all on how arguments are projected into the syntax. The complex semantic values (involving functions applying to functions) can yield any hierarchical order of the arguments. Clearly, such powerful devices must be constrained.

#### 9.4 Myler and Mali 2021

Myler and Mali (2021) present an analysis of IsiXhosa causatives which aims to analyze an alternation in the expression of the causee: the causee is either an unmarked DP or an instrumental DP (examples from Myler and Mali 2021: 8-9).

(25)	a.	uSarah	w-ong-is-e	uDallas	abantwana
		1Sarah	1SBJ-look.after-CAUS-PRF	1Dallas	2children
		“Sarah made/helped Dallas look after the children.”			
	b.	uSarah	w-ong-is-e	abantwana	ngo-Dallas
		1Sarah	1SBJ-look.after-CAUS-PRF	2children	INS-1Dallas



“Sarah made Dallas look after the children.”

In (25a), there is both a causative and a sociative (helping) interpretation, whereas in (25b) there is only a causative interpretation. In other words, the sociative interpretation is not possible with instrumental causees. Myler and Mali attempt to explain both the alternation between unmarked and instrumental causees, and the fact that only unmarked causees can have the sociative interpretation.

According to Myler and Mali, external arguments can be introduced (externally merged) in three completely different positions: Spec VoiceP (matrix clauses), Spec CauseP (causee in causative) and adjoined to vP (instrumental cause in causative). Myler and Mali claim that this analysis “...adds to the growing body of evidence that the same thematic roles are not always assigned in the same syntactic positions.” In other words, Myler and Mali claim to have found a counter-example to UTAH. They put the general issue as follows (pg. 7, fn. 4): “It follows as a consequence of this approach to the nature of thematic roles that the Uniformity-of-Theta-Assignment Hypothesis (Baker 1988: 46) is false, although linking regularities are still predicted for the general case, because the extended verb phrase is rigidly structured and is interpreted compositionally.”

Since causees are not introduced in Spec VoiceP, Myler and Mali propose a rule of coercion that inserts the thematic role predicate into vP at LF:

- (26) vP Coercion  
 $\lambda_{eS}.[P(e)...] \Rightarrow \lambda_{xe}.\lambda_{eS}.[P(e) \wedge \theta_{Ex}(e,x)...]$   
where  $\theta_{Ex}$  is a thematic role drawn from the set of roles that can be introduced by Voice and vP denotes an eventuality compatible with such a role.

Myler and Mali (2021: 27) specify the derivational timing of the vP Coercion as follows: “We will assume that vP Coercion applies to the denotation of vP when it is selected by Caus whenever failure to do so would result in the cause being unable to be integrated into the composition...”. From this, it can be seen that vP Coercion modifies a semantic value by adding in a predicate  $\theta_{Ex}(e,x)$ .

Such an operation raises immediate questions of restrictiveness. The possibility of coercion rules inserting semantic material into semantic values in a derivation is a powerful device, raising at least the following questions:

- (27) a. Should rules that directly manipulate semantic values be allowed in UG?  
b. What are the possible coercion rules made available by UG?  
c. What kinds of semantic values can be inserted?  
d. What kinds of semantic values can be inserted into?  
e. What kinds of conditions can coercion rules have on them (e.g., in (26) “can be introduced by Voice”)?

Myler and Mali do not comment on any of these restrictiveness issues in the paper.

vP Coercion is incompatible with the spirit of the Merge-based theory of argument structure: the only way to build argument structure is by Merge. The predicate  $\theta_{Ex}(e,x)$ , which is normally introduced by Voice (pg. 8), is now being directly inserted (without Merge) into the semantic value of little v during the derivation. A derivation compliant with the Merge-based

approach would be to merge a head (such as Voice) bearing  $\theta_{EX}(e,x)$  as part of its semantic value into the syntactic structure.

The alternation between an unmarked cause and an instrumental cause is reminiscent of the active-passive alternation in English, where in the passive the external argument appears in a *by*-phrase. Myler and Mali (2021: 8, fn. 7) directly address this parallel as follows:

- (28) “Another approach to such alternations is the smuggling approach, which Collins 2005 applies to passives in English and Kayne 2004 applies to transitive causes in Romance. The main reason we do not adopt such an approach to the instrumental-causee construction here is that it will not explain the disappearance of the sociative reading in this construction (see section 5.2), since the starting assumption of such analyses is that the argument in both alternants starts off in the same structural position and bears the same thematic role.”

Myler and Mali (2021: 26) note that “...the sociative reading does not appear to be allowed with inanimate causees in isiXhosa (whereas the plain causative reading of the unmarked cause is)...”. They further note that idioms are possible in causatives, but not with the sociative interpretation (pg. 38). These distinctions recall the distinction between raising and control in English:

- (29) a. John expected it to rain. (raising to object)  
b. \*John persuaded it to rain. (object control)
- (30) a. John expected the shit to hit the fan. (raising to object)  
b. \*John persuaded the shit to hit the fan. (object control)

In (29a), *expect* is a raising to object verb, and in (29b) *persuade* is an object control verb. Suppose the causative/sociative distinction worked in a similar manner. On the causative interpretation, the causative suffix is a raising to object construction. On the sociative interpretation, the causative suffix is an object control verb. On this analysis (which is different from Myler and Mali’s), it is unsurprising that the instrumental marked *causee* cannot take a sociative interpretation: if the causee is an instrument, it is then excluded from being an object of the sociative-causative verb.

## 9.5 Whither UTAH

In the discussions in chapters 1-8, no reference was made to UTAH in constraining the possibilities of projecting the external argument in the passive. Rather, all the work was done by the Argument Criterion/Theta-Criterion. This suggests the possibility that UTAH could be eliminated all together and reduced to other principles. UTAH is repeated below (see Baker 1988):

- (31) The Uniformity of Theta Assignment Hypothesis (UTAH)  
Identical thematic relationships between items are represented by identical structural relationships between those items at the level of D-structure.

There are many reasons why UTAH does not fit easily into minimalist syntax (see Collins 2005a: 83). First, it explicitly invokes D-structure, and there is no such level of representation in

minimalist syntax. Second, it makes reference to thematic relationships, raising the tricky question of how they are differentiated. Third, (31) makes reference to “items” (meaning lexical items), but syntactic representations have become much more ramified in the last 30 years, including VP shells of various kinds. It is not clear how (31) is meant to apply to these more complex structures. Lastly, it was never really exactly clear how UTAH applied to the external argument in the passive, which is the main topic of discussion of this monograph.

Baker (1997: 127, footnote 127): “...Larson correctly points out that Baker (1988) does not adopt the strictest imaginable sense of UTAH in his analysis of the passive. Rather, Baker claimed that the agent role was assigned to the specifier of IP in normal active sentences, but to the head of I containing the morpheme -EN in corresponding passive sentences. These are not identical structural relationships, but they were held to be equivalent positions inasmuch as both are ‘maximally external’ to the VP (outside VP but inside the next highest maximal projection).” This quote raises the vexing question of what count as equivalent positions. The informal description “outside VP” does little to narrow down all the possibilities.

I propose that UTAH is not a principle of UG, and I speculate that UTAH-like effects are the result of the following:

- (32) a. The universal existence of various VP shells such as VP, vP and ApplP.  
 b. A universal hierarchical order of such shells (vP > ApplP > VP).  
 c. The Argument Criterion/Theta-Criterion

This kind of analysis has already been proposed in Baker (1997: 125-126):

- (33) “The basic function of the original UTAH was to regulate where the various arguments of a predicate are expressed. This is a nontrivial task if predicates have multiple arguments of the same type, because one must keep track of which NP is associated with which argument position. If, however, syntactic structure is built from the lexical decomposition of a verb, such that each predicate in the decomposition takes a single NP argument, the UTAH becomes trivial. All that remains is a simple convention that an argument must be in a local configuration with its argument-taker; the rest follows from compositional semantics.”

Baker states: “All that remains is a simple convention that an argument must be in a local configuration with its argument taker...”. This convention is a weaker version of the Argument Criterion/Theta-Criterion in chapter 1.

One problem with this deconstruction of UTAH is that there must be some way to restrict the structural relations between the heads in the verbal extended projection. For example, assuming v, Appl and V as the relevant heads, what determines that (a) is projected and not (b):

- (34) a. [<sub>vP</sub> DP [<sub>v'</sub> v [<sub>ApplP</sub> DP [<sub>Appl'</sub> Appl VP ]]]]  
 b. [<sub>ApplP</sub> DP [<sub>Appl'</sub> Appl [<sub>vP</sub> DP [<sub>v'</sub> v VP ]]]]

Of course, one can stipulate that v takes ApplP as a complement, instead of vice versa, but such a stipulation lacks restrictiveness. What would prevent another language from having the opposite stipulation where Appl selects vP? Putting aside the lexical verb, if there are n argument introducing heads, there will be n! (n factorial) possible orders of those heads. In the general case,

only one of them will be grammatical. This is the ordering/selection problem that is familiar from works on the cartography of the left periphery.

A related hierarchy problem is the following: Why couldn't there be two light verbs  $v_1$  and  $v_2$  each of which introduce agents, but which have a different place in the hierarchy of light verbs? Some sort of non-synonymy principle may be needed to block this sort of possibility. In addition, the way that the semantic properties of an argument introducing head determine its syntactic position needs to be understood better.

At the end of the quote, Baker adds "the rest follows from compositional semantics." But if I am right, nothing about where arguments are projected in a syntactic structure really follows from the mechanisms of formal semantics.

## 9.6 What is the Problem with Formal Semantics?

The discussion above raises the question of where formal semantics goes wrong as a theory of argument structure? The basic problem is that formal semantics (as presented in standard textbooks) is far too unrestricted to serve as theory of anything, even natural language semantics. As Chomsky notes in Collins 2021:

- (35) "Work in formal semantics has been some of the most exciting parts of the field in recent years, but it hasn't been treated with the kind of critical analysis that other parts of syntax (including generative phonology) have been within generative grammar since its origins. Questions about explanatory power, simplicity, learnability, generality, evolvability, and so. More as a descriptive technology. That raises questions."

Formal semantics of the kind discussed in Heim and Kratzer 1998 employs powerful and unrestricted mechanisms of semantic composition based on the lambda calculus. And even though the lambda calculus is used to formulate semantic values in Heim and Kratzer 1998, it is itself a very powerful syntactic system. For example, single morphemes (lexical items) can be of type  $\langle e \rangle$ ,  $\langle e, e \rangle$ ,  $\langle e, t \rangle$ ,  $\langle \langle e, t \rangle, t \rangle$  or any of an unlimited number of other alternative types, including functions of functions, functions of functions of functions, functions of functions of functions of functions, etc. (see page 28).

In addition to the unlimited number of lexical types, there is also the unrestricted mechanism of type shifting that makes it so that a single syntactic object can have many different alternative types. Such rules are defined in Heim and Kratzer (1998: 68) as follows "...general recipes that map arbitrary denotations of the basic type to secondary denotations of the appropriate nonbasic type. Rules of this kind are called 'type-shifting rules'." See Pylkkänen 2008b for references and for an overview of accounting for syntax-semantics mismatches in terms of type-shifting.

Lastly, it is possible to define powerful interpretational rules (e.g., function composition) in such a framework (see the discussion of Jacobson above). As noted there, function composition gives rise to the possibility of creating dependencies between syntactic positions without invoking internal Merge.

The relevant properties are summarized here:

- (36) a. The ability to define lexical items of arbitrary semantic complexity (and arbitrary complex types).  
b. The ability to formulate rules (such as type shifting and coercion) that modify

- semantic values.
- c. The ability to define different kinds of interpretation rules (e.g., function composition).

Such powerful mechanisms present learnability issues for a child learning a language. How is the child supposed to assign semantic values to X and Y in a simple phrase like [X Y]? Of course, it might be possible to make semantic theory more restrictive by either eliminating some of these options or limiting them in some way. I am not aware of any systematic discussion of this nature.

A theory including (36) is essentially a descriptive framework for semantic analysis, and not a restrictive theory in the standard sense of *restrictive* used for syntactic theory.

- (37) “The theory of UG must meet two obvious conditions. On the one hand, it must be compatible with the diversity of existing (indeed, possible) grammars. At the same time, UG must be sufficiently constrained and restrictive in the options it permits so as to account for the fact that each of these grammars develops in the mind on the basis of quite limited evidence. In many cases that have been carefully studied in recent work, it is a near certainty that fundamental properties of the attained grammars are radically underdetermined by evidence available to the language learner and must therefore be attributed to UG itself.” (Chomsky 1981: 5)

The Merge-based theory of argument structure is not in principle incompatible with formal semantics of the kind presented in Heim and Kratzer 1998. That is, it is possible to interpret the syntactic structures generated by the theory presented in this monograph (see Kratzer 1996 for some suggestions). But the semantic rules of interpretation should be tightly constrained by the syntactic structures.

Toward this goal, consider the following principle (see also the related discussion at the end of chapter 7):

- (38) Minimize Semantic Values
- a. Minimize the number semantic arguments (lambda expressions) of the semantic value of a morpheme. Equivalently, minimize the semantic type of a morpheme.
  - b. The number of semantic arguments (lambda expressions) of the semantic value of a morpheme cannot exceed three (one for the head, specifier and complement of the projection of the morpheme).

The purpose of (38a) is to rule out super-complex semantic values such as the one which permits inversion in (23) above. The problem with the constraint is that it seems to involve a comparison of two structures (one structure involving one set of morphemes with their semantic values versus another structure involving different set of morphemes). A simpler way to limit semantic complexity might be to let it be directly constrained by syntax as in (38b). A crude first-pass attempt would be that the number of lambda expressions of a morpheme cannot exceed three (one for the head, specifier and complement of a projection). This constraint also rules out (23).

The principle in (38) goes together with the Principle of Decompositionality of chapter 7 in limiting the power of formal semantics, and thereby shifting the work to Merge and the syntactic component.

## 9.7 Conclusion

In this chapter, I have considered a number of issues that arise when thinking about argument structure in relation to theories of formal semantics. I have argued that it is not possible to eliminate the Theta-Criterion in favor of Interpretability. I have discussed a few concrete proposals, including Jacobson 2014, Pykkänen 2008a and Myler and Mali 2021. I have shown how these approaches are all inconsistent with the Merge-based theory of argument structure. On the basis of these examples, I have tried to clarify what exactly it is about formal semantics that makes it unsuitable as a theory of argument structure.

## 10 Conclusion

The goal of this monograph is to argue for a theory of argument structure based on the syntactic operation Merge.

Although the monograph has the grandiose title “Principles of Argument Structure”, I discuss only a very few topics in depth, focusing on the implicit argument in the passive, implicit arguments more generally, *by*-phrases and the dative alternation. I do not discuss any of the following topics: idiom chunks, expletives, unaccusatives, unergatives, psych verbs, syntactic causatives (e.g., *faire à* versus *faire par*), morphological causatives (e.g., in Bantu), object control versus raising to object, particle verbs, resultative secondary predicates, the spray-load alternation, verbal possession (e.g., *have* versus *be*), conflation (in the Hale and Keyser 1993 sense), action nominalizations (e.g., process versus result interpretations, see Grimshaw 1990), agent nominalizations (on a strongly Merge-based theory, see Fábregas 2012), nominal compounds, serial verb constructions (e.g., in Ewe), locative versus directional uses of PPs (see Collins 2007) and *-able* constructions (see Ishizuka and Koopman 2014).

For each such phenomena, one could try to formulate a Merge-based analysis within the restrictive framework outlined in this monograph. There are other topics that I have discussed briefly but that still need much more work (e.g. the implicit arguments with evaluative adjectives, middles, nominalizations see chapter 4).

In this chapter, I will summarize the principles of argument structure proposed in the monograph and the empirical consequences of those principles.

### 10.1 Summary

The principles of argument structure are meant to hold of any system that uses a dedicated set of verbal heads to introduce arguments (so-called, argument introducing heads). Even though the system of Kratzer (1996) (and similarly Pytkäinen 2008a) differs greatly from that of Ramchand (2008), both systems should fall under these principles.

The most important principle is the Argument Criterion:

- (1) Argument Criterion
  - a. Each argument is introduced by an argument introducing head.
  - b. Each argument introducing head introduces an argument.

In chapter 1, I pointed out that the Argument Criterion is largely equivalent to the following version of the Theta-Criterion (Chomsky 1986: 97):

- (2) Theta-Criterion  
Each argument  $\alpha$  appears in a chain containing a unique visible theta-position P, and each theta-position P is visible in a chain containing a unique argument  $\alpha$ .

From the Argument Criterion/Theta-Criterion, the following principle concerning implicit arguments follows immediately:

- (3) The implicit argument in the English passive is syntactically projected.

I gave empirical support for (3) in chapters 2 and 3. Then in chapter 4, I generalized (3) to all constructions and all languages in (4) (using the wedge argument):

(4) Implicit arguments are syntactically projected.

If implicit arguments are syntactically projected, then what are their syntactic properties? I provide a sketch of a theory in chapter 4:

- (5)
- a. Implicit arguments are syntactically projected as *pro*.
  - b. Implicit argument *pro* lacks a structural Case feature [uCase].
  - c. Implicit argument *pro* has the same range of interpretations as other pronouns.

Although the fine details of the general theory in (4) do not follow directly from the Argument Criterion, they are consistent with it. For example, (5b) does not follow directly from (4), but is consistent with it. That raises the question of what the relation between (5) and UG is, and whether (5) allows any cross-linguistic variation. Another possibility that I have not considered, but which would be consistent with AC/TC is that some implicit arguments could be null R-expressions (the equivalent of a logical constant, instead of a logical variable). I put all these issues aside.

Another direct consequence of the Argument Criterion/Theta-Criterion is the projection of *by*-phrases in the passive:

(6) The external argument of the passive is projected in exactly the same way as the external argument of the active.

Concretely, this principle entails the following analysis of *by*-phrases:

(7) The *by*-phrase is externally merged in Spec vP (the position of the external argument).

Empirical support for this prediction was given in chapter 5 based on the binding of reflexives.

I give a similar analysis to the dative alternation in chapter 8. Based on parallels with the passive, and the asymmetries of asymmetries, I argue that:

(8) The goal argument in the prepositional dative construction is projected in exactly the same way as the goal argument in the double object construction.

Concretely, this principle entails the following analysis of *to*-phrases, parallel to (7):

(9) The *to*-phrase is externally Merged in Spec ApplP (the position of goals).

(7) and (9) can be generalized in the following way:

(10) KPs are arguments (and hence obey the Argument Criterion/Theta-Criterion).



The head of KP (e.g., passive *by*, dative *to*) is by definition semantically vacuous, and is part of the extended projection of the DP.

The last consequence of the Argument Criterion/Theta-Criterion is the independence of voice and argument structure (discussed in chapter 7):

(11) Voice is independent of the projection of arguments.

Concretely, (11) entails the following (contra Kratzer 1996 and many others):

(12) The external argument is not externally merged in Spec VoiceP.

If (11) is correct, it has far-reaching implications for the analysis of various voice phenomena (e.g., passive, active, non-active, middles, inverse, anti-passives, *-able* constructions, various *se* constructions in Romance, etc.).

Lastly, in chapter 9, I discussed the tension between the Merge-based approach to argument structure, and approaches such as that of Kratzer (1996) and Heim and Kratzer (1998) that are based on formal semantics. In response to that tension, I proposed the following principles (partly modeled on the Principle of Decompositionality of Kayne 2005:121):

(13) Principle of Semantic Decompositionality  
If  $\llbracket X \rrbracket = \text{SV1}(\text{SV2})$  (SV1 and SV2 are semantic values)  
and  $\llbracket Y \rrbracket = \text{SV1}$  or  $\text{SV2}$  (where Y is a morpheme in the lexicon)  
then  $X = [\dots Y \dots]$

(13) says that if an expression is semantically complex, then it is also syntactically complex.

(14) Minimize Semantic Values  
a. Minimize the number semantic arguments (lambda expressions) of the semantic value of a morpheme. Equivalently, minimize the semantic type of a morpheme.  
b. The number of semantic arguments (lambda expressions) of the semantic value of a morpheme cannot exceed three (one for the head, specifier and complement of the projection of the morpheme).

The effect of these principles is to limit the semantic complexity of morphemes, and forcing the need for Merge-based analyses.

Pulling together the core principles and summarizing:

(15) Merge-Based Theory of Argument Structure  
a. Argument Criterion/Theta-Criterion  
b. Implicit arguments are syntactically projected.  
c. KPs are arguments (and hence obey the Argument Criterion/Theta-Criterion).  
d. Voice is independent of the projection of arguments.

I have argued that (15b,c,d) are all entailed by (15a).

## 10.2 Parallel to Morphology as Syntax (MaS)

It is worthwhile pointing out that there is a parallel between the research program outlined in this monograph, and the research program outlined in Collins and Kayne (2020) “Towards a Theory of Morphology as Syntax”. In that paper, Collins and Kayne discuss the relationship between syntax and morphology, and ask the question: To what extent can morphological generalizations be accounted for in terms of syntactic operations and principles. The thesis they defend is:

(16) Morphology as Syntax (MaS)

Morphological generalizations are accounted for in terms of syntactic operations and principles. There is no morphological component in UG. There are no post-syntactic morphological operations.

Similarly, in this monograph I have tried to sketch a Merge-based approach to argument structure, where the only way to build argument structure is by Merge. This means that arguments and argument introducing heads (predicates) should be combined by Merge. There is no other way to satisfy the lexical properties of argument introducing heads.

Whereas Collins and Kayne 2020 argue for eliminating the morphological component entirely, in this monograph I have not argued for eliminating formal semantics. Rather, I argue that generalizations concerning argument structure should be explained in terms of Merge, and not in terms of complex semantic values and complex semantic operations (see chapter 9 for an overview). For example, in the passive, the *by*-phrase is Merged in Spec vP. There is no need to rely on a theory where *by* denotes a function of functions that is combined with an unsaturated VoiceP.

Restating the results of this monograph in a way maximally parallel to (11) yields:

(17) Merge-Based Theory of Argument Structure

Generalizations about argument structure are accounted for in terms of syntactic operations and principles (in conformity with 1-14 above).

## References

- Aarts, Bas. 1995. Secondary Predicates in English. In Bas Aarts and Charles F. Meyer (eds.), *The Verb in Contemporary English*. Cambridge University Press, Cambridge.
- Ackema, Peter and Maaike Schoorlemmer. 2017. Middles. In Martin Everaert and Henk C. van Riemsdijk (eds.), *The Wiley Blackwell Companion to Syntax*.
- Alexiadou, Artemis, Elena Anagnostopoulou and Florian Schäfer. 2015. *External Arguments in Transitivity Alternations: A Layering Approach*. Oxford University Press, Oxford.
- Alexiadou, Artemis, Elena Anagnostopoulou and Florian Schäfer. 2018. Passive. In Norbert Hornstein, Howard Lasnik, Pritty Patel-Grosz and Charles Yang (eds.), *Syntactic Structures after 60 Years: The Impact of the Chomskyan Revolution in Linguistics*. De Gruyter Mouton.
- Andrews, Avery. 1982. A Note on the Constituent Structure of Adverbials and Auxiliaries. *Linguistic Inquiry* 13, 313-317.
- Angelopoulos, Nikos. 2019a. *Complementizers and Prepositions as probes: Insights from Greek*. UCLA PhD Dissertation.
- Angelopoulos, Nikos. 2019b. Reconstructing Clitic Doubling. *Glossa* 4(1).
- Angelopoulos, Nikos, Chris Collins and Arhonto Terzi. 2020. Greek and English Passives and the Role of *by*-Phrases. *Glossa* 5(1): 90, 1-29.
- Angelopoulos, Nikos and Dominique Sportiche. 2021. Clitic Dislocations and Clitics in French and Greek: From Interpretation to Structure. *Natural Language and Linguistic Theory*.
- Aoun, Joseph and Yen-hui Audrey Li. 1989. Scope and Constituency. *Linguistic Inquiry* 20, 141-172.
- Baker, Mark. 1988. *Incorporation*. Chicago University Press, Chicago.
- Baker, Mark. 1997. Thematic Roles and Syntactic Structures. In Liliane Haegeman (ed.), *Elements of Grammar*. Kluwer, Dordrecht.
- Baker, Mark, Kyle Johnson and Ian Roberts. 1989. Passive Arguments Raised. *Linguistic Inquiry* 20, 219-251.
- Baker, Mark and Collins Chris. 2006. Linkers and the Internal Structure of the vP. *Natural Language and Linguistic Theory* 24, 307-354.
- Baker, Mark and Nadya Vinokurova. 2009. On Agent Nominalizations and Why They Are Not Like Event Nominalizations. *Language* 85, 517-556.

- Barss, Andrew. 2001. Syntactic Reconstruction Effects. In Mark Baltin and Chris Collins (eds.), *The Handbook of Contemporary Syntactic Theory*. Blackwell.
- Barss, Andrew and Howard Lasnik. 1986. A Note on Anaphors and Double Objects. *Linguistic Inquiry* 17: 347-354.
- Belletti, Adriana and Chris Collins. 2020. *Smuggling in Syntax*. Oxford University Press, Oxford..
- Belletti, Adriana and Luigi Rizzi. 2012. Moving Verbal Chunks in the Low Functional Field. In Laura Burgè, Anna Cardinaletti, Giuliana Giusti, Nicola Munaro, Cecilia Poletto (eds.), *Functional Heads: The Cartography of Syntactic Structures Vol. 7*, 129-137. Oxford University Press, Oxford.
- Belletti, Adriana and Luigi Rizzi. 2013. Ways of Avoiding Intervention: Some Thoughts on the Development of Object Relatives, Passive and Control. In Massimo Piatelli-Palmarini and Robert C. Berwick (eds.), *Rich Languages from Poor Inputs*. Oxford University Press, Oxford.
- Bhatt, Rajesh and Rouyana Pancheva. 2017. Implicit Arguments. In Martin Everaert and Henk van Riemsdijk (eds.), *Blackwell Companion to Syntax*. Blackwell.
- Bianchi, Valentina. 2015. Italian Arbitrary External Arguments in Active and Passive Clauses. *Rivista di Grammatica Generativa* 37, 1-16.
- Borer, Hagit. 1998. Deriving Passive without Theta Roles. In Steven G. Lapointe, Diane K. Brentari and Patrick M. Farrell (eds.), *Morphology and its Relation to Phonology and Syntax*, 60-99. CLSI Publications, Stanford, California.
- Borer, Hagit. 2005. *Structuring Sense Volume 2: The Normal Course of Events*. Oxford University Press, Oxford.
- Borer, Hagit. 2020. Nominalizing Verbal Passive: PROs and Cons. In Artemis Alexiadou and Hagit Borer (eds.), *Nominalization: 50 Years on from Chomsky's Remarks*, 111-137. Oxford University Press, Oxford.
- Bowers, John. 1981. *The Theory of Grammatical Relations*. Cornell University Press, Ithaca.
- Bowers, John. 1993. The Syntax of Predication. *Linguistic Inquiry* 24, 591-656.
- Bowers, John. 1997. A binary analysis of resultatives. In *Proceedings of the 1997 Linguistics Society Conference, Texas Linguistic Forum* 38, 43-58.
- Bowers, John. 2010. *Arguments as Relations*. MIT Press, Cambridge.
- Bruening, Benjamin. 2013. By Phrases in Passives and Nominals. *Syntax* 16, 1-41.
- Bruening, Benjamin. 2018. Word Formation is Syntactic: Raising in Nominalizations. *Glossa* 3(1): 102, 1-25.

- Burzio, Luigi. 1986. *Italian Syntax*. Reidel, Dordrecht.
- Charnavel, Isabelle and Dominique Sportiche. 2016. Anaphor binding: What French inanimate anaphors show. *Linguistic Inquiry* 47(1), 35–87.
- Charnavel, Isabelle and Chrissy Zlogar. 2015. English Reflexive Logophors. *Proceedings of CLS* 51, 83-97.
- Chomsky, Noam. 1957. *Syntactic Structures*. Mouton, The Hague.
- Chomsky, Noam. 1982. *Lectures on Government and Binding*. Foris Publications, Dordrecht.
- Chomsky, Noam. 1986. *Knowledge of Language*. Praeger, New York.
- Chomsky, Noam. 1995. *The Minimalist Program*. MIT Press, Cambridge.
- Chomsky, Noam. 2004. Beyond Explanatory Adequacy. In Adriana Belletti (ed.), *Structures and Beyond*, 104–131 (originally published as: Chomsky, Noam. 2001. Beyond Explanatory Adequacy: MIT Occasional Papers in Linguistics 20. MIT Working Papers in Linguistics.)
- Chomsky, Noam. 2005. Three Factors in Language Design. *Linguistic Inquiry* 36, 1-22.
- Chomsky, Noam. 2013. Problems of projection. *Lingua* 130, 33-49.
- Chomsky, Noam. 2021. Minimalism: Where are we Now, and Where can we Hope to Go? *Gengo Kenkyu* 160.
- Cinque, Guglielmo. 1999. *Adverbs and Functional Heads*, New York: Oxford University Press.
- Collins, Chris. 1997. *Local Economy*. MIT Press, Cambridge.
- Collins, Chris. 2002. Eliminating Labels. In Epstein, S. D. and Seely, T. D. (eds.), *Derivation and Explanation in the Minimalist Program*, 42-64. Oxford: Blackwell.
- Collins, Chris. 2003. The Internal Structure of vP in Ju'hoan and #Hoan. *Studia Linguistica* 57, 1-25.
- Collins, Chris. 2005a. A Smuggling Approach to the Passive in English. *Syntax* 8, 81-120.
- Collins, Chris. 2005b. A Smuggling Approach to Raising in English. *Linguistic Inquiry* 36, 289-298.
- Collins, Chris. 2006. A Note on Derivational Morphology. Ms., NYU.

- Collins, Chris. 2007. Home Sweet Home. In Lisa Levinson and Oana Savescu-Ciucivara (eds.), *NYU Working Papers in Linguistics* 1.
- Collins, Chris. 2018. History of the By-Phrase in Generative Syntax (1957 to 2005). *Ordinary Working Grammarian* [Blog].
- Collins, Chris. 2021. A Conversation with Noam Chomsky about Formal Semantics. *Ordinary Working Grammarian* [Blog].
- Collins, Chris and Richard Kayne. 2020. Towards a Theory of Morphology as Syntax. Ms., NYU.
- Collins, Chris and Paul Postal. 2012. *Imposters*. MIT Press, Cambridge.
- Collins, Chris and Paul Postal 2014. *Classical NEG Raising*. MIT Press, Cambridge.
- Collins, Chris and Edward Stabler. 2016. A Formalization of Minimalist Syntax. *Syntax* 19, 43-78.
- Collins, Chris and H. Thráinsson. 1996. VP Internal Structure and Object Shift in Icelandic. *Linguistic Inquiry* 27, 391-444.
- Creissels, Dennis. 2008. Impersonal Pronouns and Coreference: the Case of French *on*. Ms., Université Lumier (Lyon 2).
- Demonte, Violeta. 1986. Predication and Passive. In Ivonne Bordelois, Heles Contreras and Karen Zagana (eds.), *Generative Studies in Spanish Syntax*, 51-66. Foris, Dordrecht.
- Diesing, Molly. 1992. *Indefinites*. MIT Press, Cambridge.
- Doron, Edit. 2015. Voice and Valence Change. In Tibor Kiss and Artemis Alexiadou (eds.), *Syntax – Theory and Analysis*, Vol. 1. De Gruyter.
- Elbourne, Paul. 2021. Literal vs enriched meaning: It's raining. In Daniel Gutzmann, Lisa Matthewson, Cécile Meier, Hotze Rullmann, and Thomas Ede Zimmermann (eds.), *The Wiley Companion to Semantics*. John Wiley and Sons, Inc.
- Embick, David. 1998. Voice systems and the syntax/morphology interface. *MIT Working Papers in Linguistics* 32.
- Embick, David. 2004. Unaccusative Syntax and Verbal Alternations. In Artemis Alexiadou, Elena Anagnostopoulou, and Martin Everaert (eds), *The unaccusativity puzzle: explorations of the syntax–lexicon interface*. Oxford: Oxford University Press, 137–58.
- Epstein, Samuel David. 1984. Quantifier-pro and the LF Representation of PROarb. *Linguistic Inquiry* 15, 499-505.

- Fábregas, Antonio. 2012. Evidence for Multidominance in Spanish Agentive Nominalizations. In Myriam Uribe-Etxebarria and Vidal Valmala (eds.), *Ways of Structure Building*, 66-92. Oxford University Press, Oxford.
- Fábregas, Antonio and Michael Putnam. 2020. *Passives and Middles in Mainland Scandinavian*. De Gruyter Mouton.
- Fillmore, Charles J. 1986. Pragmatically Controlled Zero Anaphora. In *Proceedings of the Twelfth Annual Meeting of the Berkeley Linguistics Society*, 95-107.
- Fodor, Jerry A. and Janet Dean Fodor. 1980. Functional Structure, Quantifiers, and Meaning Postulates. *Linguistic Inquiry* 11, 759-770.
- Fu, Jingqi, Hagit Borer and Tom Roeper. 2001. The VP within Nominalizations: Evidence from Adverbs and the VP Anaphor *do so*. *Natural Language and Linguistic Theory* 19, 549-582.
- Goodall, Grant. 1997. Theta-Alignment and the *By*-Phrase. In *Chicago Linguistic Society* 33, 129-139.
- Goodall, Grant. 1999. Passives and Arbitrary Plural Subjects in Spanish. In Jean-Marc Authier, Barbara E. Bullock and Lisa A. Reed (eds.), *Formal Perspectives on Romance Linguistics*, 135-150. John Benjamins Publishing Company.
- Grimshaw, Jane. 1990. *Argument Structure*. MIT Press, Cambridge.
- Grinder, John. 1971. Chains of Coreference. *Linguistic Inquiry* 2, 182-202.
- Gruber, Jeffrey. 2001. Thematic Relations in Syntax. In Mark Baltin and Chris Collins (eds.), *The Handbook of Contemporary Syntactic Theory*, 257-298. Blackwell, Oxford.
- Hale, Ken and Samuel Jay Keyser. 2002. *A Prolegomenon to a Theory of Argument Structure*. MIT Press, Cambridge.
- Hallman, Peter. 2015. Syntactic Neutralization in Double Object Constructions. *Linguistic Inquiry* 46, 389-424.
- Hallman, Peter. 2021. Explaining Siewierska's Generalization. *The Journal of Comparative Germanic* 24, 145-184.
- Harley, Heidi. 2002. Possession and the Double Object Construction. *Linguistic Variation Yearbook* 2, 31-70.
- Harley, Heidi. 2011. A Minimalist Approach to Argument Structure. In Cedric Boeckx (ed.), *Linguistic Minimalism*, 427-448. Oxford University Press, Oxford.

- Harley, Heidi. 2013. External Arguments and the Mirror Principle: On the Distinctness of Voice and v. *Lingua* 125, 34-57.
- Harley, Heidi and Hyun Kyoung Jung. 2015. In Support of the P<sub>HAVE</sub> Analysis of the Double Object Construction. *Linguistic Inquiry* 46, 703-703.
- Harley, Heidi and Shigeru Miyagawa. 2017. Syntax of Ditransitives. *Oxford Research Encyclopedia of Linguistics*.
- Hasegawa, Nobuko. 1988. Passives, Verb Raising and the Affectedness Condition. In *West Coast Conference on Formal Linguistics* 7, 99-113.
- Heim, Irene. 2011. Definiteness and Indefiniteness. In Claudia Maienborn, Klaus von Heusinger, and Paul Portner (eds.), *Semantics: An International Handbook of Natural Language Meaning (HSK 33.2)*, 996-1025. de Gruyter Mouton.
- Heim, Irene and Angelik Kratzer. 1998. *Semantics in Generative Grammar*. Blackwell, Oxford.
- Helke, Michael. 1973. On Reflexives in English. *Linguistics* 11, 5-23.
- Hoekstra, Teun and Ian Roberts. 1993. Middle Constructions in Dutch and English. In Eric Reuland and Werner Abraham (eds.), *Knowledge and Language Volume II: Lexical and Conceptual Structure*, 183-220. Springer.
- Hornstein, Norbert. 1999. Movement and Control. *Linguistic Inquiry* 30, 69-96.
- Ishizuka, Tomoko and Hilda Koopman. 2014. On the Importance of Being Silent or Pronounced: English *-able* and Japanese *-rare* Potentials Compared. Poster for GLOW 37, Brussels.
- Jacobson, Pauline. 2014. *Compositional Semantics*. OUP, Oxford.
- Jaeggli, Osvaldo A. 1986. Passive. *Linguistic Inquiry* 17.4, 587-622.
- Johnson and Postal. 1980. *Arc-Pair Grammar*. Princeton University Press, Princeton.
- Kayne, Richard. 1983. *Connectedness and Binary Branching*. Foris Publications, Dordrecht.
- Kayne, Richard. 1985. Principles of Particle Constructions. In Jacqueline Guéron, Hans-Georg Obenauer, Jean-Yves Pollack (eds.), *Grammatical Representation*. Foris Publications, Dordrecht.
- Kayne, Richard. 1994. *The Antisymmetry of Syntax*. MIT Press, Cambridge.
- Kayne, Richard. 2005. *Movement and Silence*. Oxford University Press, Oxford.
- Kayne, Richard. 2010. *Comparisons and Contrasts*. Oxford University Press, Oxford.



- Keine, Stefan and Rajesh Bhatt. 2016. Interpreting Verb Clusters. *Natural Language and Linguistic Theory* 34, 1445-1492.
- Kimball, John P. 1971. Super Equi-NP Deletion as Dative Deletion. In *Papers from the Seventh Regional Meeting of the Chicago Linguistics Society*, 142-148.
- Kiparsky, Paul. 2013. Towards a null theory of the passive. *Lingua* 125, 7-33.
- Kitagawa, Yoshihisa. 1994. Shells, Yolks and Scrambled E.g.s. In Mercè Gazàlez (ed.), *NELS* 24, 221-239.
- Koenig, Jean-Pierre. 1998. On a tué le président! The nature of Passives and Ultra-indefinites. In B. Fox, D. Jurafsky, and L. Michaelis (eds.), *Cognition and Function in Language*, 235-251. CSLI publications: Stanford.
- Koenig, Jean-Pierre and Gail Maurer. 2000. A-definites and the Discourse Status of Implicit Arguments. *Journal of Semantics* 207-236.
- Koopman, Hilda. 2003. The locality of agreement and the structure of the DP in Maasai. In William E. Griffin (ed.), *The role of agreement in natural language: TLS 5 Proceedings*, 207-227.
- Koopman, Hilda. 2005. On the parallelism of DPs and clauses: Evidence from Kisongo Maasai. In A. Carnie (ed.), *Verb First, On the Syntax of Verb-initial Languages*, 281-302. John Benjamins, Amsterdam.
- Koopman, Hilda. 2012. Samoan Ergativity as Double Passivization. In Laura Burgè, Anna Cardinaletti, Giuliana Giusti, Nicola Munaro, Cecilia Poletto (eds.), *Functional Heads: The Cartography of Syntactic Structures Vol. 7*, 168-180. Oxford University Press, Oxford.
- Koster, Jan. 1994. Predicate Incorporation and the Word Order of Dutch. In *Paths Towards Universal Grammar*, ed by G. Cinque, J. Koster, J.-Y. Pollock, L. Rizzi, and R. Zanuttini, 255-277. Georgetown University Press, Washington D.C.
- Kratzer, Angelika. 1996. Severing the external argument from its verb. *Phrase structure and the lexicon*, pp.109–137. Springer.
- Landau, Idan. 2000. *Elements of Control*. Dordrecht: Kluwer Academic Press.
- Landau, Idan. 2010. The Explicit Syntax of Implicit Arguments. *Linguistic Inquiry* 41, 357-388.
- Landau, Idan. 2013. *Control in Generative Grammar: A Research Companion*. Cambridge University Press, Cambridge.
- Lappin, Shalom and Ur Shlonsky. 1993. *Linguistics* 31, 5-24.
- Larson, Richard K. 1988. On the Double Object Construction. *Linguistic Inquiry* 19, 335-391.

- Larson, Richard K. 2010. On Pylkkänen's Semantics for Low Applicatives. *Linguistic Inquiry* 41: 701-704.
- Larson, Richard K. 2014. *On Shell Structure*. Routledge, New York.
- Legate, Julie. 2014. *Voice and v: Lessons from Achenese*. MIT Press, Cambridge.
- Legendre, Geraldine. 1997. Secondary Predicates and Functional Projections in French. *Natural Language and Linguistic Theory* 15, 43-87.
- Mahajan, Anoop. 1994. ACTIVE Passives. In Raul Aranovich, William Byrne, Susanne Preuss and Martha Senturia (eds.), *The Proceedings of the Thirteenth West Coast Conference on Formal Linguistics*, 286-301.
- Marantz, Alec. 1993. Implications of Asymmetries in Double Object Constructions. In Sam Mchombo (ed.), *Theoretical Aspects of Bantu Grammar*. CSLI.
- McCawley, James. 1988. *The Syntactic Phenomena of English*, vol. 1. The University of Chicago Press, Chicago.
- Meltzer-Asscher, Aya. 2012. Verbal Passives in English and Hebrew: a Comparative Study. In Martin Everaert, Marijana Marelj and Tal Siloni (eds.), *The Theta System: Argument Structure at the Interface*, 280-307. Oxford University Press, Oxford.
- Merchant, Jason. 2013. Voice and ellipsis. *Linguistic Inquiry* 44, 77-108.
- Moltmann, Friederike. 2006. Generic *one*, Arbitrary PRO, and the First Person. *Natural Language Semantics* 14, 257-281.
- Müller, Stefan. 2008. Depictive Predicates in German and English. In Christoph Schroeder, Gerd Hentschel und Winfried Boeder (eds.), *Secondary Predicates in Eastern European Languages and Beyond*, *Studia Slavica Oldenburgensia* 16, 255-273. BIS-Verlag, Oldenburg.
- Murphy, Andy. 2015. Double Passivization in Turkish: A Structure Removal Approach. *Proceedings of ConSOLE XXIII*, 316-339.
- Myler, Neil and Zoliswa O. Mali. 2021. Two Places for Causees in Productive IsiXhosa Morphological Causatives. *Syntax* 24, 1-43.
- Newman, Elise. 2020. Facilitator effects in middles and more. *Glossa: A Journal of General Linguistics*, 5(1), 62.
- Pesetsky, David. 1996. *Zero syntax: Experiencers and cascades* (No. 27). MIT press.

- Philippaki-Warbuton, Irene. 1975. The passive in English and Greek. *Foundations of Language* 13, 563–578.
- Postal, Paul. 1974. *On Raising*. MIT Press, Cambridge.
- Postal, Paul. 2010. *Edge-Based Clausal Syntax*. MIT Press, Cambridge.
- Pylkkänen, Liina. 2008a. *Introducing Arguments*. MIT Press, Cambridge.
- Pylkkänen, Liina. 2008b. Mismatching Meanings in Brain and Behavior. *Language and Linguistics Compass* 2/4, 712-738.
- Rappaport Hovav, Malka and Beth Levin. 2008. The English Dative Alternation: The Case for Verb Sensitivity. *Journal of Linguistics* 44, 129-167.
- Reed, Lisa. 2011. Get-passives. *The Linguistic Review* 28, 41-78.
- Reinhart, Tanya and Eric Reuland. 1983. Reflexivity. *Linguistic Inquiry* 24, 657-720.
- Rivero, Maria-Louisa. 1990. The location of nonactive voice in Albanian and Modern Greek. *Linguistic Inquiry* 21, 135–146.
- Rizzi, Luigi. 1986. Null Objects in Italian and the Theory of *pro*. *Linguistic Inquiry* 17, 501-557.
- Rizzi, Luigi. 1990. *Relativized Minimality*. MIT Press, Cambridge.
- Roberts, Ian. 1987. *The Representation of Implicit and Dethematized Subjects*. Foris, Dordrecht.
- Roberts, Ian. 1988. Predicative APs. *Linguistic Inquiry* 19, 703-710.
- Roberts, Ian. 2019. *Parameter hierarchies and universal grammar*. Oxford University Press, USA.
- Roeper, Thomas. 1987. Implicit Arguments and the Head-Complement Relation. *Linguistic Inquiry* 18, 267-310.
- Roeper, Thomas. 2020. Where are Thematic Roles? In Artemis Alexiadou and Hagit Borer (eds.), *Nominalization: 50 Years on from Chomsky's Remarks*. Oxford University Press, Oxford.
- Ross, John Robert. 1969. On the Cyclic Nature of English Pronominalization. In D.A. Reibel and S.A. Schane (eds.) *Modern Studies in English. Readings in Transformational Grammar*, 187-201. Prentice-Hall, Englewood Cliffs, New Jersey.
- Rota, Andrew. 1995. 'How does This Sentence Interpret?' The Semantics of English Mediopassives. In Bas Aarts and Charles F. Meyer (eds.), *The Verb in Contemporary English: Theory and Description*. Cambridge University Press, Cambridge.

- Rothstein, Susan. 2005. Secondary Predication. In Martin Everaert and Henk van Riemsdijk (eds), *Blackwell Companion to Syntax*. Blackwell.
- Safir, Ken. 1987. The Syntactic Projection of Lexical Thematic Structure. *Natural Language and Linguistic Theory* 5, 561-601.
- Safir, Ken. Evaluative Predicates and the Representation of Implicit Arguments. In Robert Freidin (ed.), *Principles and Parameters in Comparative Grammar*, 99-131. MIT Press, Cambridge.
- Safir, Ken and Timothy Stowell. 1988. Binominal *each*. In *Proceedings of the North East Linguistic Society 18*, ed. J. Blevins & J. Carter, 246–250. Amherst, MA: GLSA Publications.
- Schultze-Berndt, Eva and Nikolaus P. Himmelmann. 2004. Depictive Secondary Predicates in Crosslinguistic Perspective. *Linguistic Typology* 8, 59-131.
- Sichel, Ivy. 2009. New Evidence for the Structural Realization of the Implicit External Argument in Nominalizations. *Linguistic Inquiry* 40, 712-723.
- Sigurðsson, Einar Freyr and Jim Wood. 2021. On the Implicit Argument of Icelandic Indirect Causatives. *Linguistic Inquiry* 52, 579-625.
- Simon, Dan. 2018. Internal Structure of Nominals. Ms., New York University.
- Simpson, Jane. 2005. Depictives in English and Walpiri. In Nikolaus P. Himmelmann and Eva F. Schultze-Berndt (eds.), *Secondary Predication and Adverbial Modification*. Oxford University Press, Oxford.
- Sportiche, Dominique. 2017a. Reconstruction, Binding, and Scope. In Martin Everaert and Henk van Riemsdijk (eds.), *Blackwell Companion to Syntax*. Blackwell.
- Sportiche, Dominique. 2017b. Fewer Adjuncts: More Relatives. In Nicholas LaCara, Keir Moulton and Anne-Michelle Tessier (eds.), *A Schrift to Fest Kyle Johnson. Linguistics Open Access Publications*. 1.
- Synder, William and Nina Hyams. 2015. Minimality Effects in Children’s Passives. In Elisa Di Domenico, Cornelia Hamann and Simona Matteini (eds.), *Structures, Strategies and Beyond: Studies in Honour of Adriana Belletti*, 343-368. John Benjamins, Amsterdam.
- Sportiche, Dominique, Hilda Koopman and Edward Stabler. 2014. *An Introduction to Syntactic Analysis and Theory*. Wiley Blackwell.
- Stroik, Thomas. 1992. Middles and Movement. *Linguistic Inquiry* 23, 127-137.
- Stroik, Thomas. 1995. On Middle Formation: A Reply to Zribi-Hertz. *Linguistic Inquiry* 26, 165-171.

- Stroik, Thomas. 1999. Middles and Reflexivity. *Linguistic Inquiry* 30, 119-131.
- Stroik, Thomas. 2000. *Syntactic Controversies*. LINCOM.
- Stroik, Thomas. 2005. Book Review: Markus Steinbach. Middle Voice: A comparative study in the syntax-semantics interface of German. (Linguistik Aktuell; 50). *Journal of Comparative Germanic Linguistics* 8, 225-241.
- Stroik, Thomas. 2006. Arguments in Middles. In Benjamin Lyngfelt and Torgrim Solstad (eds.), *Demoting the Agent: Passive, Middle and other Voice Phenomena*, 301-326. John Benjamins Publishing Company, Amsterdam.
- Takano, Yuji. 1998. Object Shift and Scrambling. *Natural Language and Linguistic Theory* 16, 817-889.
- Travis, Lisa. 2000. Event Structure in Syntax. In Carol Tenny and James Pustejovsky (eds.), *Events as Grammatical Objects: The Converging Perspectives of Lexical Semantics and Syntax*, 145-185. CSLI Publications, Stanford, CA.
- Watanabe, Akira. 1993. AGR-Based Case Theory and its Interaction with the A-Bar System. Doctoral Dissertation, MIT.
- Williams, Alexander. 2015. *Arguments in Syntax and Semantics*. Cambridge University Press, Cambridge.
- Williams, Edwin. 1985. PRO and Subject of NP. *Natural Language and Linguistic Theory* 3, 297-315.
- Williams, Edwin. 1987. Implicit Arguments, the Binding Theory and Control. *Natural Language and Linguistic Theory* 5, 151-180.
- Wilson, Heather. 2010. Marshallese Passives: Evidence for Two Types of 'By Phrases'. *University of Pennsylvania Working Papers in Linguistics* 16, 225-234.
- Zimmermann, Malte. 2007. Overt Existential Closure in Bura (Central Chadic). In T. Friedman and M. Gibson (eds), *SALT XVII*, 333-350. Cornell University, Ithaca, New York.
- Zyman, Erik. 2017. P'urhepecha Hyperraising to Object: An Argument for Purely Altruistic Movement. In Patrick Farrell (ed.), *Proceedings of the Linguistic Society of America*, vol. 2, 1-15.
- Zyman, Erik and Nick Kalivoda. 2020. XP- and X<sup>0</sup>- movement in the Latin verb: Evidence from mirroring and anti-mirroring. *Glossa* 5(1): 20, 1-38.