

Clause structure and ergativity in Nukuoro

by

Emily Nicole Drummond

A dissertation submitted in partial satisfaction of the

requirements for the degree of

Doctor of Philosophy

in

Linguistics

in the

Graduate Division

of the

University of California, Berkeley

Committee in charge:

Professor Amy Rose Deal, Chair

Professor Peter Jenks

Professor Line Mikkelsen

Fall 2023

Clause structure and ergativity in Nukuoro

Copyright 2023
by
Emily Nicole Drummond

Abstract

Clause structure and ergativity in Nukuoro

by

Emily Nicole Drummond

Doctor of Philosophy in Linguistics

University of California, Berkeley

Professor Amy Rose Deal, Chair

This dissertation provides a description and analysis of the syntax of Nukuoro, an understudied Polynesian Outlier language spoken in the Federated States of Micronesia. A primary goal of this work is to provide documentation of Nukuoro in its cultural and historical context; as such, the first part of this thesis includes an overview of Nukuoro documentation and revitalization efforts, a grammatical sketch of the language, and an analysis of Nukuoro clause structure. In particular, I offer an analysis of SVO word order in Nukuoro as involving predicate fronting and object shift (e.g. Massam 2001), followed by movement of the subject to the high left periphery. This analysis then bears on the treatment of Nukuoro genitive relative clauses (GRCs): I claim that left-peripheral subjects are high enough to escape the CP phase, resulting in genitive case assignment to pre-verbal subjects.

The second half of this dissertation centers around ergativity in Nukuoro, which involves exponents of the well-known Polynesian *-Cia suffix. Nukuoro is typologically unusual in that it shows an ergative extraction restriction, but lacks morphological ergative and absolutive case marking; furthermore, I argue that Nukuoro clause structure does not involve movement of the transitive object to a position higher than the subject (i.e., object inversion), which runs counter to standard analyses of syntactic ergativity (e.g., Coon et al. 2014). Building on case discrimination analyses of syntactic ergativity (Otsuka 2006, 2010a; Deal 2017b), I analyze the Nukuoro ergative extraction restriction as a composite \bar{A} probe (e.g., Coon & Bale 2014; Colley & Privoznov 2020; Scott 2021), which seeks an \bar{A} feature and an absolutive Case feature on the same goal. Additionally, using evidence from licensing in non-finite clauses, I develop a theory of Case in Nukuoro where both ergative and absolutive are structural Cases, with ergative assigned by Infl (e.g., Levin & Massam 1985; Bobaljik 1993; Laka 1993; Otsuka 2000; Rezac et al. 2014). The Nukuoro pattern thus carries implications for theories of ergativity, as well as for theories of movement and Case more broadly.

De abo donu laumalie gi Soni ma de gau Nuguolo

Contents

Contents	ii
List of Figures	vii
List of Tables	viii
List of Abbreviations	x
1 Introduction	1
1.1 The Nukuoro language	5
1.2 Outline of the dissertation	6
2 Nukuoro, a Polynesian Outlier language	8
2.1 Geographic and linguistic context	9
2.1.1 Geographic context	9
2.1.2 Linguistic context	10
2.1.2.1 Linguistic classification	11
2.1.2.2 Language use and vitality	13
2.2 Existing Nukuoro documentation	16
2.2.1 The German period: 1887–1919	16
2.2.2 The Trust Territory period: 1946–1979	19
2.2.3 The modern period: 2000–present	20
2.3 The Nukuoro Documentation Project	21
2.3.1 Language and cultural documentation	22
2.3.2 Digital resources	23
2.3.3 Forthcoming print resources	26
2.3.4 Community programming	27
2.4 Conclusion	28
3 Nukuoro grammar sketch	29
3.1 Phonology and orthography	29
3.1.1 Phonemes, phonotactics, and stress	29
3.1.2 Orthography	32

3.1.3	Morphophonological processes	33
3.1.3.1	/a:/-fronting	33
3.1.3.2	Lenition	33
3.1.3.3	Reduplication	34
3.1.3.4	Consonant gemination	35
3.2	Nouns	36
3.2.1	Pronouns	37
3.2.2	Proper nouns	40
3.2.3	Determiners	41
3.2.3.1	Definite determiners	41
3.2.3.2	Indefinite determiners	43
3.2.3.3	Bare nouns	45
3.2.4	Adjectives	46
3.2.5	Numerals	48
3.2.6	Quantifiers	52
3.2.7	Demonstratives	55
3.2.8	Possession	57
3.2.9	Relative clauses	60
3.2.10	Nominalizations	63
3.3	Verbs and inflection	65
3.3.1	Transitivity and argument structure	65
3.3.1.1	Transitivity	65
3.3.1.2	Passives	68
3.3.1.3	Causatives	68
3.3.1.4	Statives	69
3.3.1.5	Reciprocals	70
3.3.1.6	Noun incorporation	71
3.3.2	Oblique elements	72
3.3.2.1	Prepositions	72
3.3.2.2	Locational nouns	73
3.3.2.3	Oblique anaphors	75
3.3.3	Pluractionality	76
3.3.3.1	Participant number	76
3.3.3.2	Augmentation	77
3.3.4	The <i>-Cia</i> suffix and the particle <i>ina</i>	78
3.3.5	Directionals	80
3.3.6	Adverbs	81
3.3.7	Tense, aspect, mood, and negation	82
3.3.7.1	Aspect and mood	82
3.3.7.2	Tense	87
3.3.7.3	Negation	88
3.4	Clauses and clausal phenomena	89

3.4.1	Word order and case marking	90
3.4.2	Non-verbal predicates	92
3.4.3	Comparatives and superlatives	96
3.4.4	Existentials and ‘have’ constructions	97
3.4.5	Complement clauses	99
3.4.5.1	Finite complement clauses	100
3.4.5.2	Subjunctive complement clauses	101
3.4.5.3	Nominalized complement clauses	102
3.4.6	Adjunct clauses	104
3.4.6.1	Verbal adjunct clauses	104
3.4.6.2	Nominal adjunct clauses	105
3.4.6.3	Clause chaining	106
3.4.7	Imperatives	106
3.4.8	Conjunction and disjunction	107
3.4.8.1	Conjunction	107
3.4.8.2	Disjunction	109
3.4.9	Modality	110
3.5	Questions, focus, and topic	113
3.5.1	Questions	113
3.5.1.1	Polar questions	113
3.5.1.2	Content questions	114
3.5.2	Focus	119
3.5.3	Topic	120
4	Nukuoro clause structure	122
4.1	Predicate fronting	125
4.2	Object shift and noun incorporation	132
4.3	Subject movement to pre-verbal position	138
4.3.1	Subjects are in Spec,CP	140
4.3.2	Pre-verbal subjects are not hanging topics	143
4.3.3	Modeling subject movement	145
4.4	Conclusion	149
5	Genitive relative clauses and pseudoclefts	151
5.1	Genitive relative clauses	154
5.1.1	GRC basics	154
5.1.2	Genitive subjects are RC-internal	158
5.1.3	An analysis of the Nukuoro GRC	161
5.2	The structure of <i>wh</i> - and focus constructions	167
5.3	Conclusion	171
6	Syntactic ergativity without inversion	172

6.1	Analyses of ergative extraction restrictions	175
6.1.1	Inversion accounts	175
6.1.2	Problematic ergative accounts	177
6.2	Syntactic ergativity without inversion	178
6.2.1	Ergative extraction and <i>-(C)ia/ina</i>	178
6.2.1.1	Realizations of <i>-(C)ia/ina</i>	179
6.2.1.2	The ergative extraction restriction	180
6.2.1.3	Other uses of <i>-(C)ia/ina</i>	182
6.2.2	Nukuoro lacks inversion	186
6.2.3	Interim summary	190
6.3	Case discrimination as composite probing	191
6.3.1	Clause structural assumptions	191
6.3.2	Composite probing for [Ā] and [ABS]	194
6.3.3	Repairs and other functions of <i>-(C)ia/ina</i>	198
6.3.4	Comparison with inversion accounts	201
6.4	Against alternative accounts	202
6.5	Conclusions	205
7	Abstract ergative Case assignment	208
7.1	Morphological case and agreement in Nukuoro	211
7.1.1	Case and case-like phenomena	211
7.1.2	Agreement-like phenomena	217
7.2	Evidence for abstract ergative Case	220
7.2.1	Nukuoro non-finite constructions	221
7.2.2	Ergatively-aligned licensing behavior	224
7.3	A model of structural ergative and absolutive Case	227
7.3.1	The proposal: Flexible intransitives	229
7.3.2	Accounting for Nukuoro	233
7.3.3	Challenges for inherent and configurational accounts	238
7.3.3.1	Inherent approaches	238
7.3.3.2	Configurational approaches	240
7.4	Extensions and predictions of the account	242
7.4.1	Morphological splits	242
7.4.2	Syntactic splits	247
7.4.3	Multiple case assignment and “overwriting” effects	249
7.5	Conclusion	252
8	Conclusion	254
8.1	Empirical, areal, and typological contributions	254
8.1.1	Nukuoro documentation and revitalization	254
8.1.2	Polynesian syntax	255
8.1.3	Ergative typology	256

8.2	Theoretical implications	256
8.2.1	Clause structure	256
8.2.2	Syntactic ergativity	257
8.2.3	Case assignment and representation	258
Bibliography		260
A Glossed texts		278
A.1	Introduction	278
A.2	Taalanga o Vave (10-1) – Gininga	278
A.3	Tailahahahaodengadubua (11-1) – Molia	341
A.4	Taalanga o Dabedoo (11-2) – Lina	362
A.5	Taalanga o Iaidelangi (11-3) – Otto	365
A.6	Iaidebaba (11-4) – Otto	367
A.7	Taalanga o Vave (11-5) – Otto	374
A.8	Tailahahahaodengadubua (11-6) – Otto	378
A.9	Taalanga o Vave (11-8) – Leaba	392
A.10	Taalanga o Vave (12-1) – Haini	410
A.11	Taalanga o Vave (12-3) – Deiao	423
A.12	Taalanga o Vave (13-7) – Haini	446

List of Figures

1.1	Location of Nukuoro Atoll within the Pacific (Drummond & Rudolph 2021:147)	5
2.1	Map of Pohnpei State, Federated States of Micronesia (Balick et al. 2019)	10
2.2	Satellite image of Nukuoro Atoll (courtesy of NASA)	11
2.3	Map of Nukuoro Atoll with islet names, created with Johnny Rudolph	12
2.4	Classification of Nukuoro and Micronesian languages within the Oceanic family . . .	13
2.5	Polynesian subgrouping based on Marck (2000)	14
2.6	Northern Outlier subgrouping, based on Wilson (2021) and Walworth et al. (in prep) .	14
2.7	Diagram of a Nukuoro house (Kubary 1900:47)	18
2.8	Several kinds of Nukuoro axes (Kubary 1900:45)	19
2.9	Elicitation interview with Emily Drummond and Johnny Rudolph over Zoom	22
2.10	Johnny Rudolph interviews Andelise Fred	24
2.11	Andelise Fred weaves a coconut palm mat	25
2.12	A story told by Johnny Rudolph featured on the NDP website	26

List of Tables

1.1	Morphological vs. syntactic ergativity (Deal 2016b:168)	2
2.1	Previous documentation of the Nukuoro language	17
3.1	Nukuoro consonant inventory	30
3.2	Nukuoro vowel inventory	30
3.3	Possible VV combinations in Nukuoro	31
3.4	Orthographic consonants	32
3.5	Orthographic vowels	32
3.6	Unmarked pronouns	37
3.7	<i>a</i> -class genitive pronouns	40
3.8	<i>o</i> -class genitive pronouns	40
3.9	Determiner <i>de</i> fused with genitive forms	40
3.10	Nukuoro numerals	48
3.11	Nukuoro quantifiers	52
3.12	Middle verbs	67
3.13	Locational nouns	74
3.14	Nukuoro reflexes of *-Cia	78
3.15	Directionals	80
3.16	Aspect/mood particles in Nukuoro	83
3.17	Modal categories and their expression	110
3.18	Question words	114
4.1	Summary of word order patterns	148
5.1	Case marking of arguments in relative clauses	156
6.1	Idiosyncratic forms of verbs marked by <i>-(C)ia</i>	179
6.2	Predicted vs. attested Case-based extraction restrictions	207
7.1	Behavior of middle objects in Nukuoro	216
7.2	Predictions for licensing in non-finite clauses	224
7.3	Licensing in Nukuoro non-finite clauses	226

7.4 Empirical characteristics of ergatives and absolutes in Nukuoro 227

List of Abbreviations

1	first person	EVID	evidential	PFV	perfective aspect
2	second person	EXCL	exclusive	PL	plural
3	third person	FOC	focus	PN	proper name
A	<i>a</i> -class genitive	FUT	future	POL	polite
ABS	absolutive	GEN	genitive	POSS	possessive
ACC	accusative	HAB	habitual	PREP	preposition
AOR	aorist tense	HUM	human	PRES	present tense
ART	article	INA	<i>ina</i> particle	PROX	proximal deictic
BEN	benefactive	INC	inchoative aspect	PRSP	prospective aspect
CAUS	causative	INCL	inclusive	PST	past tense
CIA	-(<i>C</i>) <i>ia</i> form	IND	indicative	PTCP	participle
CL	classifier	INT	interrogative	Q	question particle
COMP	complementizer	IPFV	imperfective aspect	RCPR	reciprocal
CONT	continuative aspect	IRR	irrealis mood	RED	reduplication
COP	copula	MED	medial deictic	REL	relativizer
DEF	definite article	NC	noun class	SBJV	subjunctive mood
DEM	demonstrative	NEG	negation	SG	singular
DET	determiner	NFUT	non-future tense	SPEC	specific article
DIR	directional	NMLZ	nominalizer	STAT	stative
DIST	distal deictic	NOM	nominative	SUBJ	subject
DISTR	distributive	O	<i>o</i> -class genitive	SUP	super plural
DU	dual	OBJ	object	VOC	vocative
EMPH	emphatic	OBL	oblique anaphor		
ERG	ergative	PERF	perfect aspect		

Acknowledgments

The only place these acknowledgements can begin is with the Nukuoro community in Pohnpei, who have shown me so much kindness over the last eight years. This dissertation would not exist without the dedication and generosity of Johnny Rudolph, who started this journey with me and always encouraged me to dream bigger; I couldn't have asked for a better teacher, collaborator, team leader, and comedian to work with. I am equally grateful to Mina Lekka and Ruth Rudolph for the time and patience that they spent working with me over the years. I owe a lot to the countless Nukuoro people who have shared their food, homes, culture, stories, and language with me: Dagger Soulik, Itaia Fred, Ben Adolph, Harson Henry, Koisimy Rudolph, Cindy Lekka, Ben Ludwig, Alice Ziegler, Anelise Fred, Sigi Gideon, Juity Hainrich, Helen Amon, April, Nova, and Hellenoa. I will always be grateful for the opportunity to know and learn from you all.

I also need to thank the many researchers who have worked on Nukuoro alongside me, both in Micronesia and at Berkeley. In particular, I am grateful to Lydia Ding, Margaret Asperheim, and Leonie Maurer for their collaboration and friendship during trips to Pohnpei. I am also indebted to the Berkeley undergraduate researchers who helped me process an incredible amount of field data: Arielle Urquico, Stuart Litjen, Anjelica Ramos, Molly Pinder, Shaylan Dias, Zhihan Cheng, Crystal Torres, Amber Boyd, Alyssa Chen, Sam Stahl, and especially Cor Zanda, for sharing my fascination with Polynesian historical syntax.

I never would have set foot in Micronesia if it weren't for David Harrison and the Swarthmore Field School, which introduced me to field linguistics and changed the course of my life. I was lucky to experience fieldwork for the first time with a group of fast friends—Joey, Joe, Maria, Sarah, Lewis, and Lydia. As I explored linguistics more in the Tri-Co, there was no shortage of incredible mentors (which was a wonderful surprise, given that I originally went to Bryn Mawr to study math). Brook Lillehaugen, Emily Gasser, and Shizhe Huang laid the foundation for this dissertation by showing me so many ways to do really good linguistics. Shizhe was the one who originally encouraged me to pursue a PhD, and somehow, she knew from the beginning that I would end up at Berkeley.

Here, I was incredibly fortunate to be trained by three formidable fieldworker-syntacticians, who shaped me into the linguist I am today. I couldn't have picked a better advisor than Amy Rose Deal, who taught me how to create my own diagnostics when all others failed, let the data speak for itself, and make sure that people cared what I had to say. I'm grateful for the many hours that she spent untangling data with me, reading countless drafts, and teaching me to be a better scholar. I also credit Amy Rose for refining my taste in cocktails and reminding me that milestones should always be celebrated, preferably with themes.

My other committee members, Peter Jenks and Line Mikkelsen, have also made a huge impact on me as an academic and a person. I thank Peter for his infectious enthusiasm about syntax, his encouragement to pursue even the wildest ideas, and his solid advice on balancing description and theory. Line never failed to be a kind and thoughtful sounding board, whether it was in her office or over dinner, and I'm grateful for the clarity that I always found after our meetings. I would also like to thank Line for being a role model for me in language revitalization, along with Beth Piatote, Patricia Baquedano-López; all three have demonstrated a level of care, responsibility,

and joy in their work that I can only hope to emulate. In unofficial capacities, I have received so much guidance and support from other faculty members at Berkeley as well—particularly Andrew Garrett, who always showed enthusiasm about my work and provided a valuable perspective on syntactic variation and change. I consider myself very lucky to have been surrounded by faculty so deeply invested in my research and my success.

My time at Berkeley, especially during the pandemic, would have been quite bleak without the amazing members of my cohort—Wesley dos Santos, Emily Grabowski, and Maddy Bossi (don't worry, she'll get a bigger shout-out later)—and many other department friends, including Emily Clem, Ginny Dawson, Zach O'Hagan, Hannah Sande, Edwin Ko, Tessa Scott, Myriam Lapierre, Justin Royer, Eric Wilbanks, Karee Garvin, Schuyler Laparle, Allegra Robertson, Dakota Robinson, Becky Jarvis, Katie Russell, Shweta Akolkar, Franco Liu, Anna Macknick, Amber Galvano, Julianne Kapner, and Irene Yi. I'm so grateful for all of the lunches, drinks, coffee breaks, walks, park hangs, and parties over the years, and for all of the advice and commiseration you provided me along the way.

I owe just as much to my friends outside of Berkeley linguistics, who kept me grounded: Madison Brown, Danny Kirsch, Alex Kushner, Ben Goldstein, Maddie Wood, Priscilla Dias, Sabrina Martin, Michael Martin, Callie Lopshire-Bratt, Claire Lesage, Richard Bibbs, Anjelica Casey, Emma Buechner, Jackie Mendelson, Lexie Tyson, Emma Fredgant, and Anne-Marie Varga. I would also like to thank my book club, the UC Berkeley Chamber Choir, all the friends and co-workers who trusted me to tattoo them in my apartment, and Christine at MY Coffee, who definitely saw me at my worst but graciously never said anything.

I am so grateful to my family, especially to Mom and Dad, who have shown me so much love and support through all my degrees, performances, career shifts, and cross-country moves. Thanks also to my grandparents, for the endless pride they have in me; to Tim, Emily, Kyle, and Alex, for the phone calls and basement games of pool; to Barb, my other mother; and to my cats, Poppy and Chia, for reminding me (forcefully) to take breaks.

Last but not least, I would like to thank Maddy again, this time as my wife (!), for literally being alongside me every step of the way. I couldn't have done this without you, and I'm so glad I don't have to do the rest of my life without you either.

Chapter 1

Introduction

This dissertation investigates clause structure, case, and movement through the lens of ergative alignment, a system where the transitive subject is distinguished from other core arguments. Ergativity is a notably heterogeneous phenomenon: as research on ergative languages has expanded over the last few decades, it has become clear that there is no one way for a language to be ergative (Johns 2000; Deal 2015a; Coon et al. 2017). One key way that ergative languages differ is in their expression of ergative alignment across domains. Some languages reflect ergativity in their morphology, but show no ergative behavior for the purposes of syntactic operations, such as \bar{A} -movement. This pattern is instantiated by Niuean (Tongic; Polynesian), which marks overt ergative and absolutive case (1) but allows all arguments to undergo unmarked relativization (2).

- (1) a. Ne fano e tehina haaku.
 PST go ABS brother POSS
 ‘My little brother went.’
 b. Ne kai [he puti ia] e moa.
 PST eat ERG cat DEM ABS chicken
 ‘That cat ate the chicken.’ (Niuean; Seiter 1980:29)
- (2) a. e tagata [ne moto e koe ____{ABS}]
 ABS person NFUT punch ERG 2SG
 ‘the person who you punched’
 b. e tagata [e kai ____{ERG} e talo]
 ABS person FUT eat ABS taro
 ‘the person who will eat the taro’ (Niuean; Seiter 1980:94)

Other languages express ergativity in both the morphology and the syntax, preventing ergative arguments from participating in certain syntactic operations. This pattern is found in the closely related language Tongan (Tongic; Polynesian), which marks ergative and absolutive case (3) yet also shows an \bar{A} -movement restriction for ergative arguments: relativization of a transitive subject requires a resumptive pronoun in subject position (4).

- (3) a. Na'e 'alu 'a Sione.
 PST go ABS Sione
 'Sione went.'
- b. Na'e kai ['e Sione] 'a e mango.
 PST eat ERG Sione ABS DEF mango
 'Sione ate the mango.' (Tongan; Otsuka 2000:50)
- (4) a. e fefine ['oku 'ofa'i 'e Sione ____{ABS}]
 DEF woman PRS love ERG Sione
 'the woman whom Sione loves'
- b. e fefine ['oku *(ne) 'ofa'i 'a Sione]
 DEF woman PRS 3SG love ABS Sione
 'the woman who loves Sione' (Tongan; Otsuka 2000:116)

The previous examples illustrate that ergativity can be divided into two related but distinct phenomena: *morphological ergativity*, which describes the expression of ergative alignment in case marking and/or agreement; and *syntactic ergativity*, which describes the expression of ergative alignment in syntactic operations. It has often been claimed that morphological ergativity is a precondition for syntactic ergativity—in other words, all languages which show syntactic ergativity also show morphological ergative case or agreement (Dixon 1994). Restricting our attention to transitive subject extraction as a hallmark of syntactic ergativity, this generalization yields the typology in Table 1.1.¹

	Transitive subject can extract	Transitive subject cannot extract
Morphologically ergative	✓	✓
Morphologically non-ergative	✓	—

Table 1.1: Morphological vs. syntactic ergativity (Deal 2016b:168)

Ergative phenomena have played an integral role in the development of theories of clause structure and case, largely because they appear to violate classic assumptions about clausal hierarchy. Subjects are standardly assumed to be base-generated higher than objects; on traditional case-theoretic approaches, where case is assigned via agreement with functional heads (e.g., Chomsky 1981, 2000), it is unclear how to assign the same case value to intransitive subjects and transitive objects, but not to the transitive subject. A similar challenge arises when accounting for ergative extraction restrictions: if intransitive and transitive subjects are highest in the

¹Transitive subject extraction is just one of many syntactic phenomena that fall under the umbrella of syntactic ergativity, which also encompasses asymmetries in coreference across clauses, coreferential deletion, and control, among others. For further discussion on this topic, see Deal (2015a) and Polinsky (2017b).

clause, it is difficult to explain why intransitive subjects, but not transitive subjects, are accessible for \bar{A} -movement.

One standard response to this challenge is to propose that transitive subjects are not, in fact, the highest argument in the clause, but rather that transitive objects systematically move to a position higher than the subject, a phenomenon known as object inversion. In accounting for Case assignment, inversion accounts have proposed that objects move to receive absolutive Case from T/Infl, effectively recasting absolutive as nominative Case (Murasugi 1992; Bittner & Hale 1996a,b; Ura 2001; Legate 2008b); ergative arguments are assigned Case in their base position by the head that introduces them (e.g., v^0), making ergative an inherent Case (Woolford 1997, 2006; Aldridge 2008; Legate 2008b). Inversion is also standardly invoked to account for ergative extraction restrictions: analyses in this vein propose that inverted objects intervene for the purposes of subject \bar{A} -movement, for reasons that vary from account to account (Campana 1992; Ordóñez 1995; Bittner & Hale 1996a,b; Coon et al. 2014; Assmann et al. 2015; Ershova 2019; Clemens & Tollan 2021; Coon et al. 2021; Tollan & Clemens 2022).

In this context, this dissertation describes and analyzes patterns of ergativity in Nukuoro, a Polynesian Outlier language spoken in the Federated States of Micronesia. Nukuoro demonstrates a previously-unattested combination of properties: first, it does not mark overt ergative or absolutive case or agreement, displaying a neutral alignment in matrix clauses (5); second, it shows a restriction on the \bar{A} -movement of ergative arguments, requiring transitive subject relative clauses to include a verbal suffix *-(C)ia* and/or the post-verbal particle *ina* (6). These morphemes are the Nukuoro reflexes of Proto-Polynesian *-Cia (Chung 1978; Pawley 2001), a suffix which is related to alignment and transitivity in many Polynesian languages.

- (5) a. Tama laa ne anu.
 DET.child DIST PFV dance
 ‘That child danced.’ (ML-20210709)
- b. Tama laa ne doolohi de gaagoo.
 DET.child DIST PFV chase DET chicken
 ‘That child chased the chicken.’ (ML-20210709)
- (6) a. de beebaa [a de hine ne dau ____{ABS}]
 DET book GEN.A DET woman PFV read
 ‘the book that the woman read’ (JR-20230106)
- b. *de hine [____{ERG} ne dau de beebaa]
 DET woman PFV read DET book
 ‘the woman who read the book’ (JR-20230906)
- c. de hine [____{ERG} ne dau-lia (ina) de beebaa]
 DET woman PFV read-CIA INA DET book
 ‘the woman who read the book’ (JR-20230106)

Nukuoro constitutes a counterexample to the typology in Table 1.1, providing an instance of syntactic ergativity in the absence of ergative morphology. Furthermore, I show that unlike many languages described to have ergative extraction restrictions, Nukuoro clause structure does

not involve object inversion: subjects always remain highest in the clause, reflecting the base-generated hierarchy of arguments. As such, the Nukuoro pattern raises two main questions for theories of ergativity. First, in the absence of object inversion, what prevents \bar{A} -movement of the ergative subject? Second, in the absence of morphological case, does abstract Case underlie the extraction restriction, and if so, how is it assigned?

To answer this first question, I argue that syntactic ergativity in Nukuoro does not arise as a result of an inverted clause structure, but rather by Case-sensitive conditions on movement. Building on previous case discrimination analyses of ergative extraction restrictions (Otsuka 2006, 2010a; Legate 2008a; Deal 2017b), I propose that the Nukuoro restriction arises as a result of a composite \bar{A} -probe (e.g., Coon & Bale 2014; Colley & Privoznov 2020; Scott 2021), which searches for [\bar{A}] and [ABS] features simultaneously. I implement this mechanism using an Interaction-Satisfaction model of Agree (Deal 2015b, 2022), where a probe can halt as a result of *conjunctive satisfaction* by two features found on the same goal. Ergative arguments fail to undergo \bar{A} -movement simply because they lack absolutive Case, and thus cannot meet the requirements of the probe; I propose that *-(C)ia/ina* realizes an additional v projection, which obviates the restriction by assigning absolutive Case to the transitive subject. This analysis of Nukuoro *-(C)ia/ina* is reminiscent of cross-linguistic ergative extraction repairs, which also provide last-resort licensing (e.g., Coon et al. 2014) or antipassivize the object, allowing the subject to receive absolutive Case (e.g., Bittner & Hale 1996a).

As for the second question, I propose that Nukuoro does assign abstract ergative Case, which underlies the restriction on ergative extraction. Evidence for abstract Case comes from ergatively-aligned licensing patterns in non-finite clauses: in contexts which lack aspect marking, namely subjunctive clauses, imperative clauses, and clausal nominalizations, transitive subjects fail to be licensed. Assuming that lack of aspect marking is indicative of the absence of finite Infl, this pattern suggests that Infl is the locus of ergative Case licensing in Nukuoro (Levin & Massam 1985; Bobaljik 1993; Laka 1993; Otsuka 2000; Rezac et al. 2014). This view contrasts with other standard accounts of ergative Case assignment, which characterize ergative as an inherent Case assigned by v /Voice (Woolford 1997, 2006; Aldridge 2004; Anand & Nevins 2006; Legate 2008b, 2012; Mahajan 2012) or a configurational case assigned to the higher or lower of two DPs in the same Case domain (Marantz 1991; Baker 2014, 2015; Baker & Bobaljik 2017; Yuan 2022). In this way, Nukuoro shows that abstract ergative Case exists in the absence of morphological case (e.g., van der Wal 2015; Sheehan & van der Wal 2016; Halpert 2016), reaffirming that case cannot be viewed as a purely morphological phenomenon (contra Marantz 1991; Bobaljik 2008).

The primary empirical focus of study in this dissertation is the syntax of Nukuoro, but this work is just one facet of a larger project to document and revitalize Nukuoro language and culture. For this reason, this dissertation also aims to provide a broader description of the language, the context of its documentation, and the resources that we have created to support language revitalization. In the remainder of this introductory chapter, I provide a brief overview of the Nukuoro language, followed by a more detailed outline of the structure of the dissertation.

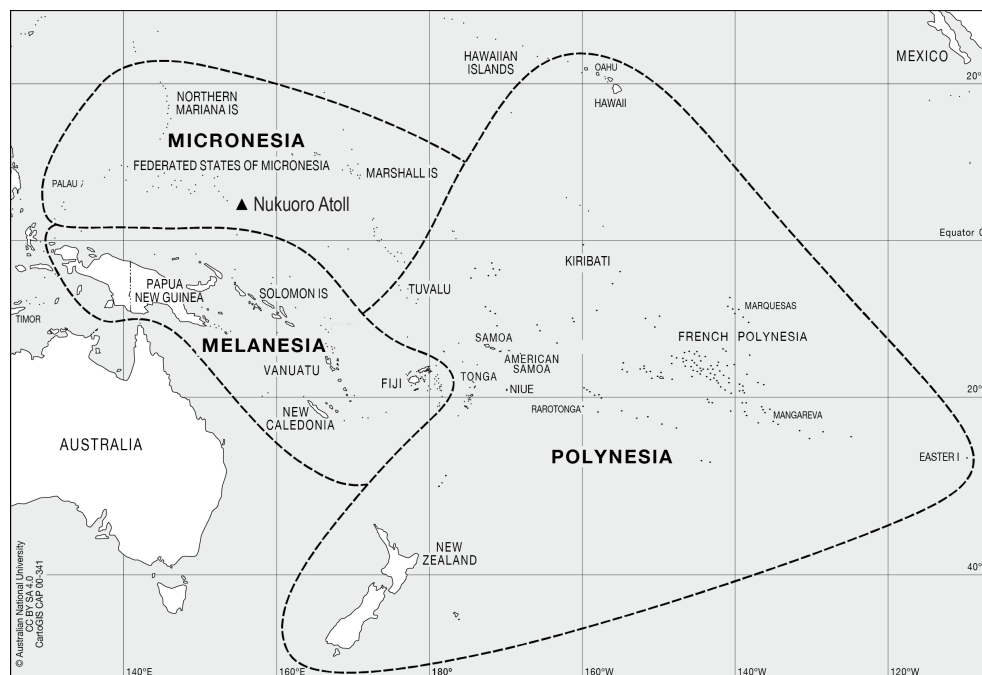

Figure 1.1: Location of Nukuoro Atoll within the Pacific (Drummond & Rudolph 2021:147)

1.1 The Nukuoro language

Nukuoro (pronounced [nu.ku.ó.ro]) is a Polynesian language spoken on Nukuoro Atoll, a low-lying coral island in Pohnpei State, Federated States of Micronesia (Figure 1.1). It is the northernmost of the Polynesian Outliers, a geographically-defined group of sixteen Polynesian cultures which lie outside of the primary region of Polynesian influence, known as the Polynesian Triangle. It is generally accepted that Polynesian Outlier communities were settled as a result of backmigration, with seafaring groups originating from the area of Tonga, Samoa, and Tuvalu and settling in areas already populated by Oceanic groups (Feinberg & Scaglione 2012). Polynesian Outlier languages are known for their internal linguistic diversity, which likely arose via contact with non-Polynesian languages (Marck 2000).

There are an estimated 1,200 Nukuoro speakers worldwide (Drummond & Rudolph 2021b), with the majority of speakers located in the Federated States of Micronesia, Guam, and the United States. About 150 speakers reside on Nukuoro Atoll, the home island of the community, while nearly 800 live in the state capital of Kolonia, Pohnpei, and at least 250 speakers live in diaspora communities elsewhere around the world, with growing populations in Guam and the mainland United States. By these estimates, the Nukuoro diaspora community is at least 8 times the size of the community on Nukuoro Atoll. While Nukuoro is the primary language spoken on Nukuoro Atoll, almost all speakers living on Pohnpei are multilingual in Pohnpeian and English. In com-

munities outside of Micronesia, Nukuoro is spoken very little.

The material presented in this dissertation is the result of an eight-year collaborative project to document and revitalize the Nukuoro language and culture, which was undertaken alongside Johnny Rudolph, Ruth Rudolph, Mina Lekka, and many, many others. Nukuoro linguistic examples are primarily drawn from elicitation interviews, which were conducted in person in Kolonia, Pohnpei and Nukuoro Atoll in 2015, 2016, and 2019, and remotely from 2020-present. All speakers were born on Nukuoro Atoll and are Nukuoro-dominant, though they also speak Pohnpeian (Micronesian) and English. Additional examples are drawn from narrative recordings made in 2015 and 2016, as well as from a collection of monolingual oral narratives recorded by Raymonde Carroll between 1963 and 1966 (Carroll 1980).

Data that come from elicitation sessions and recorded narratives are cited with the speaker code(s) and date of the recording session in YYYYMMDD format (e.g., JR-20230414).² All recordings and transcriptions are available in the Nukuoro Field Materials collection (2019-24) housed in the California Language Archive at the University of California, Berkeley.³ Data that come from the 1966 textual corpus are cited with the storyteller's name, the numerical identification code of the story from Carroll (1980), and the line number (e.g., Gininga, 10-1, line 4). The glossed and translated versions of these stories are provided in Appendix A.

1.2 Outline of the dissertation

This dissertation is divided into three main parts. The first two chapters provide a descriptive overview of the Nukuoro language and its context; the next two chapters analyze the structure of Nukuoro clauses; and the final two chapters investigate the ergative properties of Nukuoro within the larger theoretical context.

Chapters 2 and 3 provide a description of the Nukuoro language, including its linguistic and cultural context, ongoing documentation and revitalization practices, and an overview of Nukuoro grammar. In Chapter 2, I provide information about the linguistic classification and geographic context of Nukuoro, as well as a guide to existing documentation of the language. This chapter also describes the Nukuoro Documentation Project, a collaborative effort between linguists and community leaders to develop resources for language revitalization. Chapter 3 provides a description of a number of topics in Nukuoro phonology and morphosyntax, which supplements the existing documentation of the language (e.g., Carroll 1965a; Carroll & Soulik 1973).

Chapters 4 and 5 provide an analysis of Nukuoro clause structure, including the structure of basic clauses as well as genitive relative clauses. While Polynesian languages largely show verb-initial word orders, Nukuoro uses basic SVO word order. In Chapter 4, I show that Nukuoro displays two phenomena that are typically associated with Polynesian languages, namely object

²For recordings that involved multiple speakers, I provide all speaker codes in order to properly identify the cited recording; however, this practice occasionally obscures which speaker provided the specific utterance. In cases where there was relevant interspeaker variation, I mention this explicitly in the prose. Otherwise, any utterance was provided by (at least) one speaker, and confirmed (or at least not outright rejected) by the other speakers present.

³This collection is available online: <http://dx.doi.org/doi:10.7297/X2M32T4N>.

shift and predicate fronting. Pre-verbal subjects then undergo A-movement to a position higher than the fronted predicate, which I identify as Spec,CP. In Chapter 5, I turn to the derivation of genitive relative clauses (GRCs) in Nukuoro, which mark pre-verbal subjects with genitive case. Contra previous approaches to Polynesian GRCs (e.g., Herd et al. 2011), I suggest that genitive subjects occupy the same position as matrix subjects, namely Spec,CP; in this position, subjects are outside of the CP phase and thus accessible for genitive case assignment from the higher nominal domain. In addition to providing the first in-depth analysis of clause structure in an SVO Polynesian language, the claims developed in Chapters 4 and 5 provide the basis for understanding patterns of Nukuoro ergativity, which is the focus of the final section of the dissertation.

In Chapter 6, I describe and analyze the Nukuoro ergative extraction restriction. Unlike most examples of syntactic ergativity, which are claimed to arise from systematic inversion of the object over the subject (e.g., Aldridge 2004; Bittner & Hale 1996a; Coon et al. 2014; Clemens & Tollan 2021; Coon et al. 2021), Nukuoro demonstrably lacks object inversion: subjects are higher than objects at all points in the derivation, as evidenced by subject A-dependencies and binding possibilities. In light of this, I develop a case discrimination analysis of ergative extraction, which implements case discrimination as a composite probe that searches for [\bar{A}] and [ABS] features on the same goal. This type of approach unifies syntactic ergativity with other instances of mixed A/ \bar{A} -movement (e.g., van Urk 2015; Colley & Privoznov 2020; Scott 2021; Branam & Erlewine 2022) and extends to capture a wide range of Case-related asymmetries in extraction.

Chapter 7 examines the implications of Nukuoro ergativity for Case Theory more broadly. I demonstrate that despite lacking morphological case on core arguments, Nukuoro shows an abstract ergative pattern of Case assignment. This Case pattern is apparent in non-finite clauses, where ergative arguments alone fail to be licensed in the absence of finite Infl. Not only does this ergative licensing pattern provide evidence for abstract Case, which underlies the extraction restriction described in Chapter 6, but it also suggests that ergative Case is assigned structurally by Infl in Nukuoro (Levin & Massam 1985; Bobaljik 1993; Laka 1993; Otsuka 2000; Rezac et al. 2014). Rather than adopting a more traditional transitivity condition on Case assignment (e.g., Levin & Massam 1985; Bobaljik 1993; Legate 2008b), I develop a novel mechanism of Case assignment which I call a *flexible intransitive* approach, where intransitive subjects agree with both Infl and *v*. The morphological alignment of a language may then be determined by one or more post-syntactic impoverishment rules (Halle & Marantz 1993; Bonet 1991; Noyer 1992), which allows a single system to capture a wide range of morphological patterns and alignment splits.

The conclusion presented in Chapter 7 highlights various implications that the Nukuoro pattern has for theories of clause structure, the typology of case and ergativity, and analyses which seek to capture the range of ergative patterns in the world's languages.

Chapter 2

Nukuoro, a Polynesian Outlier language

The primary empirical data discussed in this dissertation are drawn from eight years of collaboration with speakers of Nukuoro, a Polynesian language spoken in the Federated States of Micronesia (FSM). The linguistic analysis presented here constitutes just one facet of the Nukuoro Documentation Project, a joint effort between linguists and community members to preserve Nukuoro language and culture. The goal of this chapter is to present the Nukuoro language in its linguistic and geographic context, and to describe the collaborative language documentation and revitalization work that we have undertaken. In addition to creating new documentary materials, we have aimed to make existing documentary materials accessible to community members, develop community programming to support language vitality, and create digital and print resources for language and cultural education in the Nukuoro community.

The major challenges to language maintenance in the Nukuoro community stem from migration, education, and rapidly changing social context. Our work seeks to address these challenges by creating resources which meet the needs of Nukuoro community members across the globe, can be used in traditional and Western educational contexts, and honor older forms of the language while also allowing space for innovation and change.

This chapter is laid out as follows. In section 2.1, I provide some information on the geographic and linguistic context of Nukuoro: §2.1.1 describes the geography of Nukuoro Atoll and its relationship to Micronesian and Polynesian geography and culture, while §2.1.2 provides information about linguistic classification, ecology, and vitality. In section 2.2, I outline previous resources on the Nukuoro language, which were primarily created by German scholars Johann Stanislaus Kubary (Kubary 1900) and Carl Jeschke (Jeschke 1913), as well as the American anthropologists Vern and Raymonde Carroll (Carroll 1964, 1965a,b; Carroll & Soulik 1973; Carroll 1980). Finally, section 2.3 provides a brief history of the Nukuoro Documentation Project, including a description of current and future projects that aid in Nukuoro linguistic and cultural revitalization.

2.1 Geographic and linguistic context

Nukuoro is a Polynesian language spoken by about 1,200 people, with speech communities in the Federated States of Micronesia, Guam, and the United States (Drummond & Rudolph 2021). It is important to locate the Nukuoro language within both the Polynesian and Micronesian language contexts: the cultural history and grammatical structure of the language is largely inherited from Polynesian, connecting Nukuoro to languages like Samoan and Tuvaluan, yet it exists within a larger Micronesian geographic and cultural landscape.

In this section, I describe the geographic and linguistic context of Nukuoro. As mentioned previously, Nukuoro belongs to a group of Polynesian Outlier languages, which are spoken outside of the primary area of Polynesian settlement. These languages are the closest linguistic relatives of Nukuoro, and share a number of grammatical features. Kapingamarangi is linguistically and geographically closest to Nukuoro; the next closest languages are Nukuria, Takuu, and Nukumanu, spoken in Papua New Guinea, and Luangiua and Sikaiana, which are spoken in the Solomon Islands. I then turn to Nukuoro language use and its language ecology, including the vitality of the Nukuoro language.

2.1.1 Geographic context

Nukuoro Atoll is a member of an island group known as the Caroline Islands; it is one of the six outlying islands of Pohnpei State, Federated States of Micronesia, alongside Kapingamarangi, Sapwuahfik (formerly Ngatik), Pingelap, Mwoakilloa (Mokil), and Oroluk. Over the last fifty years, many residents of these outlying islands, including Nukuoro, have migrated to live on the capital island of Pohnpei, where there is greater access to employment, education, and technology. A map of Pohnpei State is provided in Figure 2.1.

The island of Nukuoro sits on a nearly circular coral reef, consisting of 48 distinct islets (*modu*) circling a saltwater lagoon that measures approximately six kilometers in diameter (Figure 2.2). Each islet is named as indicated in Figure 2.3; over time, some islets have been connected together into one by filling in the channel between them with earth and trees, while other islets have been washed away or newly constructed (Carroll 1964). The population of Nukuoro Atoll primarily resides on the largest islet, which is called *Hale* ‘house/home’ or *Nuguolo*. Sea water enters and leaves the lagoon through the channel (*ava*), which lies between the islets of Gausema and Sunugudai on the south side of the atoll; this channel is the only path for boats to enter and exit the lagoon. Life on the atoll is sustained by fishing and the farming of taro, breadfruit, bananas, pandanus, and coconuts. With the exception of the Western-style school and the Christian church, most structures are built in the traditional Polynesian style, with a raised platform, open sides, and woven palm thatching on the roof. Running water and wired electricity are limited to the school building, with other electric devices powered by generators.

In the broader geographic context, Nukuoro is the northernmost of the Polynesian Outliers, a term that refers to sixteen Polynesian communities and languages found outside of geographic Polynesia, the area that lies between Aotearoa (New Zealand), Hawai‘i, and Rapa Nui (Easter Island). Polynesian Outlier communities are scattered across five Pacific island nations: the Feder-

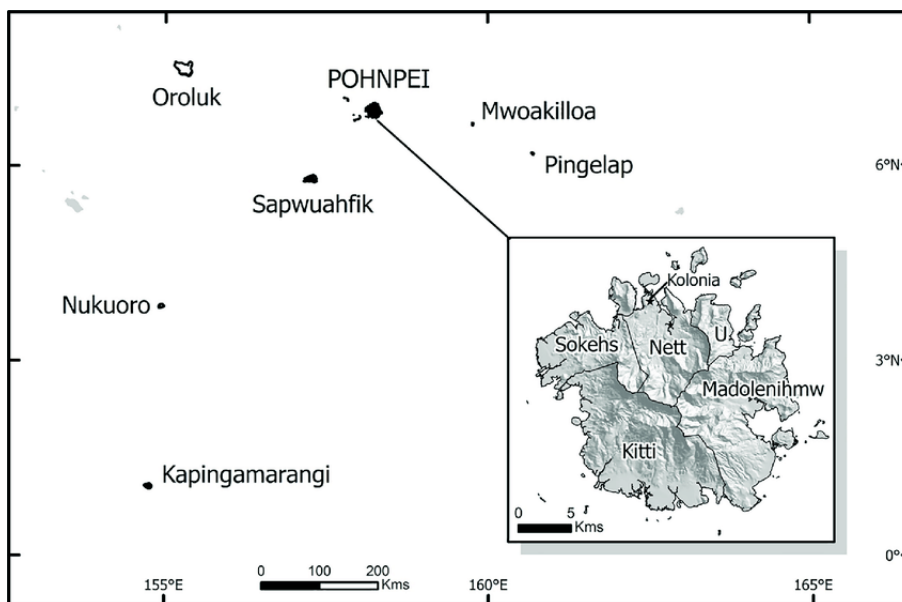

Figure 2.1: Map of Pohnpei State, Federated States of Micronesia (Balick et al. 2019)

ated States of Micronesia (Nukuoro, Kapingamarangi), Papua New Guinea (Nuguria, Nukumanu, Takuu), the Solomon Islands (Luangiua, Sikaiana, Vaeakau-Taumako, Rennell, Bellona, Anuta, Tikopia), Vanuatu (Emae, Mele, Futuna-Aniwa) and New Caledonia (Fagauvea). The Polynesian Outliers were settled as a result of backmigration from the area of Western Polynesia, which includes Tonga, Samoa, and Tuvalu.

According to archaeological and folkloric evidence, Nukuoro Atoll was settled by seafaring Polynesians sometime around 900-1000 A.D (Davidson 1992). Nukuoro oral history suggests that the original settlement party came from Manu'a, an island group in Samoa, led by a man named Vave.¹ According to the versions of the story recorded by Kubary (1900) and Jeschke (1913), the original settlers visited at least 12 different islands on the way to their final destination, which can be located in modern day Kiribati, Tuvalu, Tokelau, the Solomon Islands, and Papua New Guinea. Several stories of Vave's original settlement were recorded in the early 1960s by Raymond Carroll, which are available in Appendix A along with English glosses and translations.

2.1.2 Linguistic context

This section describes the linguistic context of Nukuoro, including its classification within Polynesian and its use and vitality within the Micronesian and American contexts. As an outlying

¹All recorded accounts place the origin of the Nukuoro settlers in Manu'a, Samoa except for Kubary (1900), who writes that Vave and his party came from Nukufetau, an atoll in Tuvalu. Jeschke (1913) lists Nukufetau as one of the islands that was visited en route from Samoa to Nukuoro.



Figure 2.2: Satellite image of Nukuoro Atoll (courtesy of NASA)

island of Pohnpei State, FSM, Nukuoro is in close contact with Micronesian languages, notably Pohnpeian, the lingua franca of Pohnpei State, as well as Chuukese and Mortlockese, two languages spoken on islands in the neighboring Chuuk State.

2.1.2.1 Linguistic classification

Nukuoro is a member of the Polynesian language family, a group of about 30 languages spoken on islands throughout the remote Pacific Ocean. Polynesian languages are a well-defined group within the Oceanic family, a language family that groups many languages of the Pacific. Most other languages spoken in the Federated States of Micronesia, including Pohnpeian, are Oceanic languages, which form a Micronesian subgroup. The classification of Nukuoro and its neighboring Micronesian languages within the larger Austronesian family is provided in Figure 2.4.

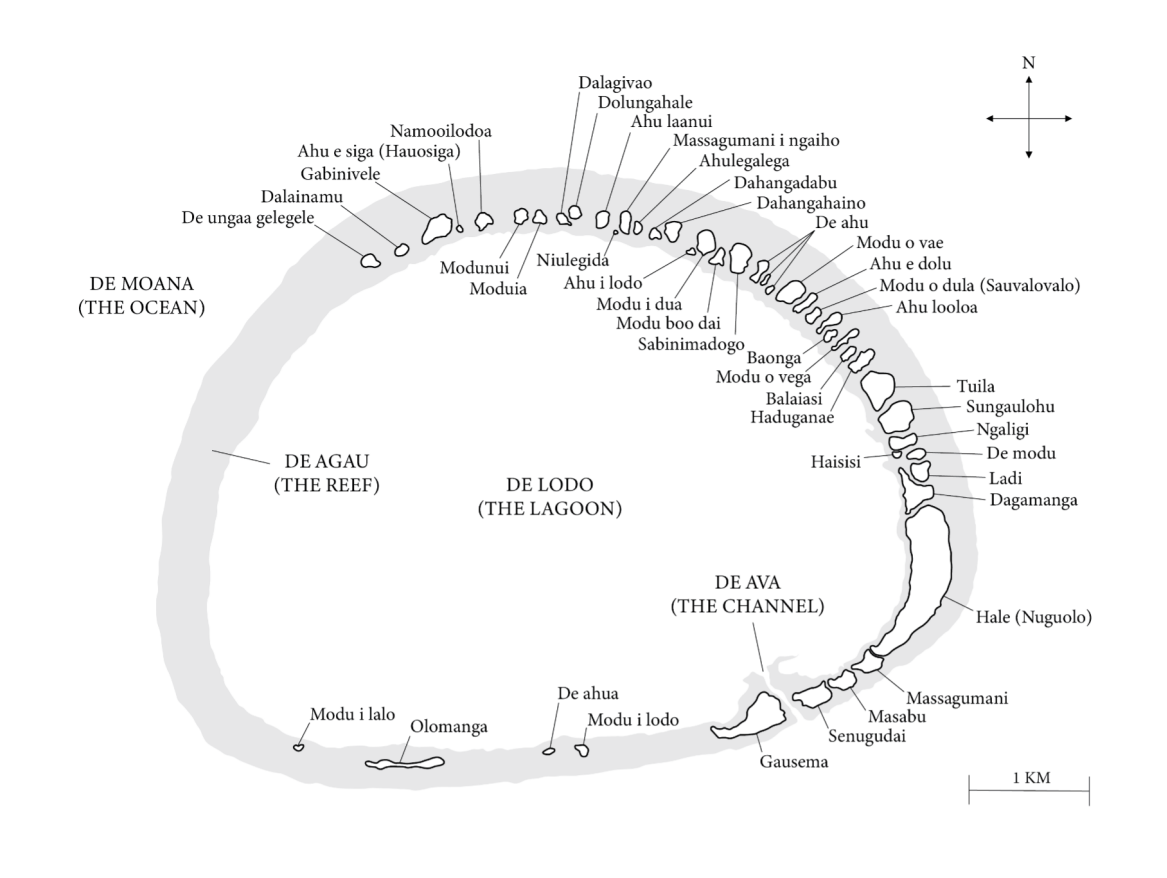

Figure 2.3: Map of Nukuoro Atoll with islet names, created with Johnny Rudolph

The Polynesian languages can be categorized into several large groups based on their shared linguistic innovations, which are summarized in Figure 2.5. Tongan and Niuean form their own higher-order subgroup, which is called Tongic; all other languages fall into the Nuclear Polynesian subgroup. While there are many languages within Nuclear Polynesian that are not further categorized, Marck (2000) proposes a further subgroup of Ellicean languages, which contains Samoan, several Outlier languages including Nukuoro, and a clear subgroup of Eastern Polynesian languages, which includes Hawaiian and New Zealand Māori.

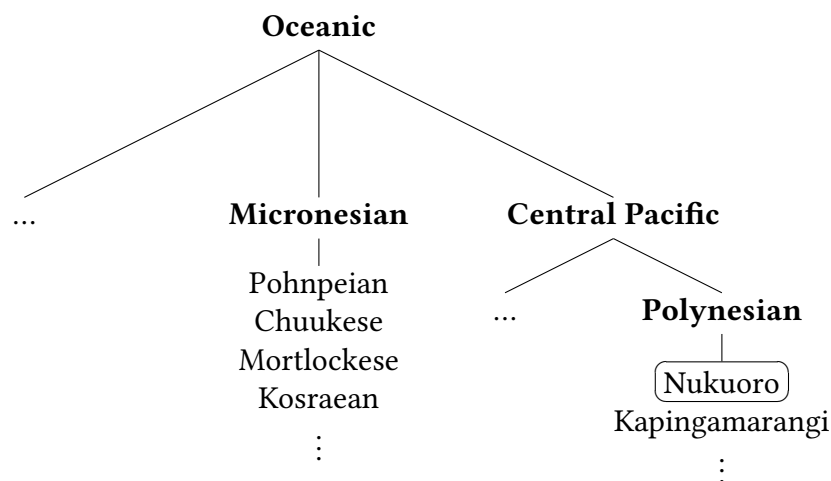

Figure 2.4: Classification of Nukuoro and Micronesian languages within the Oceanic family

Recent comparative and phylogenetic evidence suggests that Nukuoro falls into a Northern Outlier group, which consists of Nukuoro, Kapingamarangi, Nukuria, Takuu, Nukumanu, Luangiua, and Sikaiana (Wilson 2012, 2014, 2018, 2021; Walworth & Davletshin 2019; Walworth et al. in prep). On all accounts, this Northern Outlier subgroup can be further divided, with Nukuoro and Kapingamarangi forming their own subgroup, which Wilson (2012) labels the Carolinean Outliers, to the exclusion of the other Northern Outliers, namely Nukuria, Takuu, Nukumanu, Luangiua, and Sikaiana. This uncontroversial subgrouping internal to the Northern Outliers is provided in Figure 2.6.

A subject of current debate is the status of Eastern Polynesian with respect to the Northern Outlier subgroup. While Eastern Polynesian languages have traditionally been assumed to have originated in Central Western Polynesia, near Samoa and Tonga, Wilson (2012, 2014, 2018, 2021) has since claimed that Eastern Polynesian languages originated in the Northern Outliers, which he terms the Northern Outlier-Eastern Polynesian (NO-EPn) hypothesis. On his view, Eastern Polynesian languages would form a subgroup with the central Northern Outliers: Nukuria, Takuu, Nukumanu, and Luangiua. The NO-EPn hypothesis has not been supported by recent phylogenetic evidence, however: in their model, Walworth et al. (in prep) find evidence for five distinct Outlier groups, none of which are connected with Eastern Polynesian. Instead, they find that Eastern Polynesian is closely grouped with Samoan and Tuvaluan, reflecting the earlier hypothesis that Eastern Polynesian migration originated from Central Western Polynesia.

2.1.2.2 Language use and vitality

As indicated earlier, Nukuoro is spoken by about 150 people on Nukuoro Atoll and about 800 speakers on the island of Pohnpei, both located within Pohnpei State, Federated States of Micronesia (Drummond To appear). At least 250 speakers live in diaspora communities elsewhere

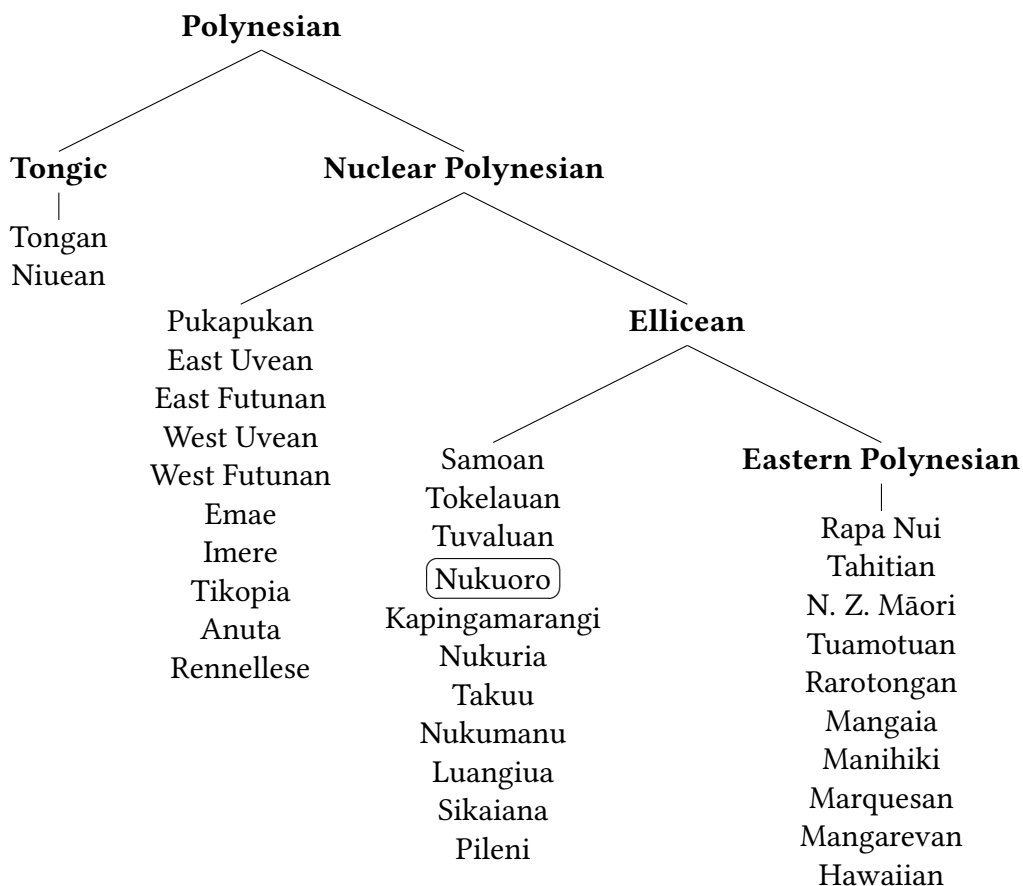

Figure 2.5: Polynesian subgrouping based on Marck (2000)

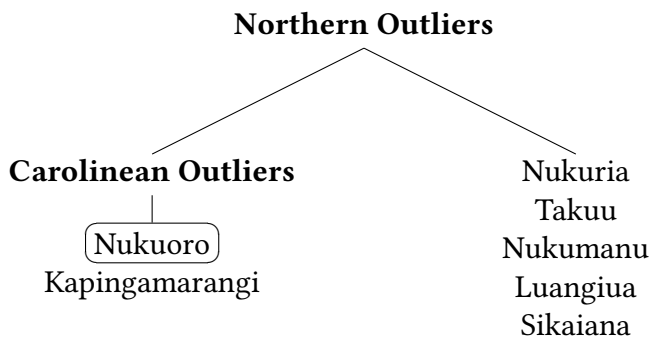

Figure 2.6: Northern Outlier subgrouping, based on Wilson (2021) and Walworth et al. (in prep)

around the world, with growing populations in Guam and the mainland United States. The largest Nukuoro communities in the U.S. are found in North Carolina, South Carolina, and Oregon,

but speakers also reside in Hawai'i, California, Washington, Kansas, Arkansas, Texas, and other states.

Nukuoro remains the primary language of use in all domains on Nukuoro Atoll, whose population has fluctuated quite a bit over the last century. Kubary (1900) names 124 residents of Nukuoro Atoll during his visit in 1887; the 2000 FSM census puts the population on the atoll at about 300, while the population in 2010 is listed at 210. While there is no more recent population data, Nukuoro community members estimate that the current population of Nukuoro Atoll is between 150 and 200 people. The population is likely decreasing as a result of rising sea levels, which has resulted in heavy saltwater intrusion in the island's taro patches, and migration to Pohnpei, Guam and the United States for educational and economic reasons.

Outside of Nukuoro Atoll, almost all Nukuoro speakers are multilingual in Pohnpeian, English, or both. On Pohnpei, which has the largest concentration of speakers, Nukuoro is typically used in the home and at community events. Outside of the home, speakers code-switch between Nukuoro and Pohnpeian, or speak Pohnpeian entirely; for younger Nukuoro speakers in particular, the variety of Nukuoro that they speak is heavily influenced by Pohnpeian, and quite different from the varieties of older Nukuoro speakers. Nukuoroans living abroad in Guam and the U.S. report that children in these communities grow up speaking little to no Nukuoro, instead using primarily English.

In general, intergenerational transmission of cultural and linguistic knowledge within the Nukuoro community is rapidly decreasing, due to the increased pressures of migration and Westernization within the community. On Pohnpei and in the U.S., children and young adults find the traditional Nukuoro language and way of life to be outdated or irrelevant, competing with languages and value systems prescribed by their education and their peers. These attitudes create a lack of mutual understanding between older and younger generations: elders feel that their values are not carried forward by the younger speakers, while younger speakers feel that elders are out of touch with their current realities. As a result, younger speakers are less likely to have learned information about specialized linguistic domains, such as environmental terminology, cultural terminology, and oral narration, and have less knowledge of traditional lifestyle practices, such as house-building, canoe-building, wood carving, palm weaving, and fishing.

For these reasons, variation within the Nukuoro speech community largely falls along generational lines: younger speakers use more lexical borrowings and frequently code-switch with Pohnpeian and English. Speakers ages 40 and under also show several grammatical differences from elder speakers, the most salient being a lack of genitive marking in relative clauses (see Chapter 5) and less frequent use of VSO word orders (see Chapter 4). Speakers report that there also exist linguistic differences among Nukuoro families, which are primarily lexical in nature and stem from taboos around sharing specialized plant and medicinal terminology. There does not appear to be significant geographic variation in Nukuoro speech, even between speakers living on Nukuoro Atoll and speakers living on Pohnpei; this may be because there is fairly consistent contact between these two populations, particularly student travel between Nukuoro and Pohnpei that aligns with the school calendar.

2.2 Existing Nukuoro documentation

This section provides an overview of previous documentation of the Nukuoro language. Resources about the Nukuoro language can be categorized into three periods, which correspond to notable time periods in Micronesian history. The first period of documentation arose from German involvement in the Pacific from the late 19th century into the 20th century (the “German period”), constituting the first published documentation of Nukuoro language and culture. After the Japanese occupation of Micronesia between World War I and World War II, the period of United States trusteeship in the Federated States of Micronesia began (the “Trust Territory period”). During this period, anthropologists from the U.S., namely Samuel Elbert, Vern Carroll, and Raymonde Carroll, conducted linguistic and ethnographic documentation on Nukuoro. The third period began in the 21st century and continues today (the “modern period”), with an expansion of documentary materials on the Nukuoro language and history, including print and digital resources intended for use by the Nukuoro community as well as outsiders.

Existing documentation of Nukuoro is primarily lexical and ethnographic in nature, though there is a brief grammatical sketch (Carroll 1965a), a glossed and translated narrative (Carroll 1965b), and a collection of untranslated Nukuoro narratives (Carroll 1980). All known work that includes documentation of the Nukuoro language is summarized in Table 2.1.

2.2.1 The German period: 1887–1919

The earliest descriptions of Nukuoro language and culture were written during the German colonial period in the FSM in the late 19th and earliest 20th centuries. These include ethnographic accounts of Nukuoro written by Johann Stanislaus Kubary (1900) and Carl Jeschke (1913), as well as an overview of the results of the Hamburg South Seas Expedition compiled by Anneliese Eilers (1934). The documentary materials that they produced describe the language, history, religion, customs, oral tradition, behavior, physical attributes of Nukuoro people, intended for an academic audience in Europe. The linguistic information contained within these documents was recorded prior to the establishment of a standard Nukuoro orthography; as a result, Nukuoro words are transliterated using non-standard spellings which reflect the German orthographic conventions of their authors.

Johann Stanislaus Kubary, a Polish naturalist and ethnographer, visited Nukuoro in 1873 and 1877 as a collector for the Godeffroy Museum in Hamburg, Germany. Kubary visited Nukuoro at a time when traditional religion and culture were still practiced, prior to Christian missionization in the early 1900s. For this reason, Kubary’s (1900) account is the only surviving record of many Nukuoro religious and cultural information, including societal organization, deities and ritual celebrations, tattooing practices, and taboos. Kubary recorded many lexical items in various domains, including place names, body parts, flora and fauna, deities, parts of houses and canoes, tools, and weavings; this vocabulary is supplemented by hand-drawn diagrams of material goods, two of which are reproduced in Figures 2.7 and 2.8. Kubary’s account ends with a comparative word list of Nukuoro and Samoan, including numerals and pronouns; certain recorded forms like

Source	Title	Resource type
Kubary (1900)	Contributions to the knowledge about the Nukuoro or Monteverde Islands	Article
Jeschke (1913)	History of the Nukuoro Islanders	Article
Eilers (1934)	Islands around Ponape	Overview article
Christian (1898)	Nuku-oro vocabulary	Word list
Elbert (1946)	Kapingamarangi and Nukuoro word list	Word list
Carroll (1964)	Place names on Nukuoro Atoll	Article
Carroll (1965a)	An outline of the structure of the language of Nukuoro: Part I	Sketch grammar
Carroll (1965b)	An outline of the structure of the language of Nukuoro: Part II	Translated narrative
Carroll (1966)	Nukuoro kinship	PhD dissertation
Stone (1966)	Some vernacular names of plants from Kapingamarangi and Nukuoro Atolls	Article
Carroll & Soulik (1973)	<i>Nukuoro Lexicon</i>	Dictionary
Carroll (1980)	<i>Nukuoro Stories</i>	Book of monolingual narratives
Kaufmann & Wick (2013)	<i>Nukuoro: Sculptures from Micronesia</i>	Edited volume on Nukuoro history

Table 2.1: Previous documentation of the Nukuoro language

⟨matatoru⟩ ‘thirty’ (cf. modern Nukuoro *matolu*) suggest that consonant gemination had not yet fully grammaticalized in the language (see §2.3 of chapter 3).

Another ethnographic account of Nukuoro was written by Carl Jeschke (1913), a German sailor who visited Nukuoro Atoll several times between 1910 and 1913. Jeschke writes that at the time of his visits, Nukuoro people had already converted to Christianity; this new religion was enforced by the last traditional chief, Leka, who had been educated at an American missionary school in Kosrae. As a result, many of the traditional customs of Nukuoro culture were no longer practiced at that time, including dancing, smoking, wooden idol carving, and some amount of storytelling. There is also no mention of tattooing in Jeschke’s account, suggesting that traditional tattoo practice had largely ended as well. Jeschke recorded fifteen short stories in German from the oral history of Nukuoro, which tell the story of Vave and many other historical encounters with Polynesian and Micronesian visitors to the island.

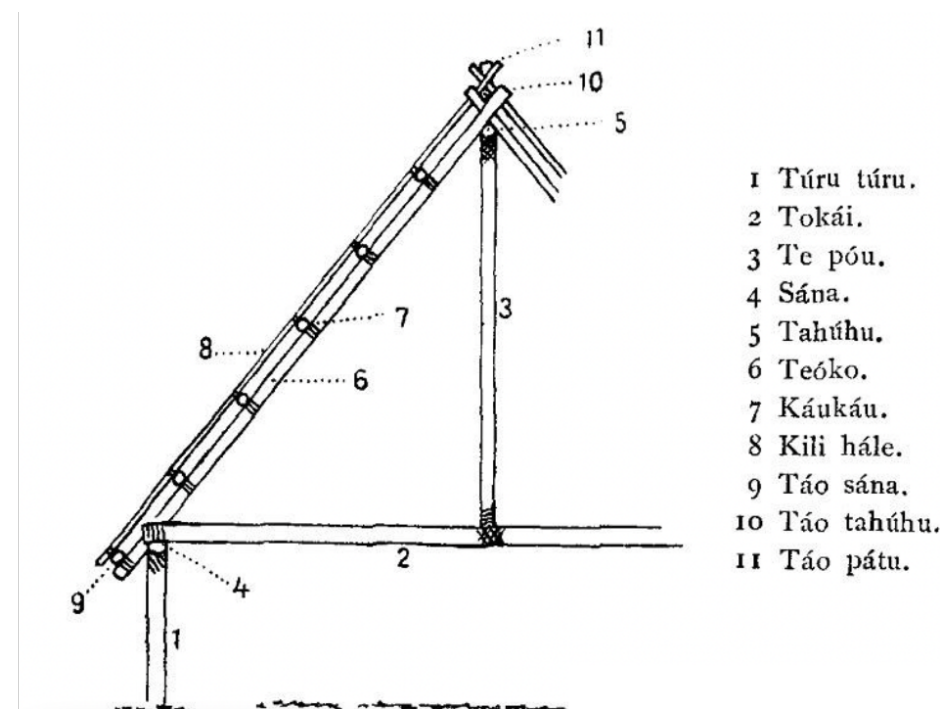

Figure 2.7: Diagram of a Nukuoro house (Kubary 1900:47)

Unique to Jeschke's documentation are records of several mnemonic chants, which were used to memorize names or lexical items in various cultural domains. Jeschke records the abbreviated mnemonic forms and the known full names of Nukuoro chiefs, fish species, shells, plants, pandanus species, and the islets of Nukuoro Atoll. Only the islet chant is still known to Nukuoro speakers today; Jeschke's transliteration of the chants are provided in Appendix B, alongside my reconstruction of the abbreviations and their corresponding full names in modern Nukuoro orthography. Jeschke also recorded the names of the eight traditional Nukuoro clans, ocean currents, months, and the islands that were visited by Vave on the journey to Nukuoro; these can be found in Appendix B as well alongside their modern orthographic equivalents. Finally, Jeschke provides a brief vocabulary of the Nukuoro language.

Other documentary materials published in this period include a Nukuoro word list published by F. W. Christian (1898) and a chapter written by Anneliese Eilers (1934) summarizing the results of the Hamburg South Seas Expedition, which stopped on Nukuoro only for a few hours on January 24, 1910. Nonetheless, Eilers' description of Nukuoro social structure and oral narratives are diligent and detailed, much of it reproduced from Kubary (1900) and Jeschke (1913). Theode-Arora (2013) provides an overview of the German sources on Nukuoro language and culture, including more details about their authors and the context of their visits.

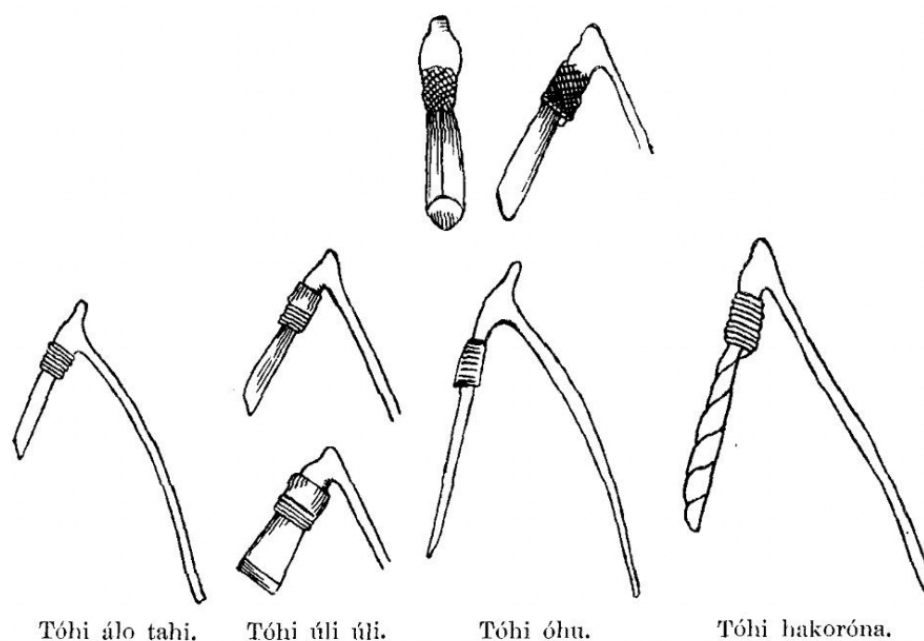

Figure 2.8: Several kinds of Nukuoro axes (Kubary 1900:45)

2.2.2 The Trust Territory period: 1946–1979

A second period of Nukuoro documentation occurred while Micronesia was part of the Trust Territory of the Pacific Islands, which was administered by the United States after World War II, when Japanese control of the islands ended. As American political interest in Micronesia increased, so did American interest in languages and cultures of Micronesia. For instance, the American linguist Samuel Elbert was employed by the U.S. Navy during World War II to compile word lists for Nukuoro and Kapingamarangi (Elbert 1946).

Several authoritative sources on the Nukuoro language were created by Vern and Raymonde Carroll, two American anthropologists who conducted anthropological and linguistic research on Nukuoro Atoll from 1963 to 1966. Their combined output, which involved immense contributions by Nukuoro speaker Tobias Soulik, comprises seven sources on the language, place names, and kinship system of Nukuoro. These include an article about place naming on Nukuoro Atoll (Carroll 1964), a grammatical sketch (Carroll 1965a), a glossed and translated Nukuoro narrative (Carroll 1965b), a doctoral dissertation on Nukuoro kinship (Carroll 1966), an article on Nukuoro adoption practices (Carroll 1970), an 800-page Nukuoro lexicon (Carroll & Soulik 1973), and a book of more than 325 monolingual Nukuoro narratives (Carroll 1980).

The linguistic documentation of Nukuoro contained within these sources primarily focuses on lexical items and narratives. The 1973 lexicon contains an enormous number of Nukuoro

words; however, many derivational forms, such as reduplicated or affixed forms, are not well defined. The 36-page sketch grammar contains notes on phonology and morphology, outlining the definitions and uses of functional morphemes; there is otherwise little syntactic or semantic description. The narrative corpus in Carroll (1980) is extensive and published entirely in Nukuoro, with no English translations; the foreword indicates that corresponding reel-to-reel recordings of these narratives exist, although it is unclear where these tapes are located today.

Additional resources created during this period include a short list of Nukuoro plant names (Stone 1966) and several Nukuoro children's books, which were created in the 1950s and 60s by the Education Department in Pohnpei. Copies of these books are only available through the library at the University of Hawai'i at Mānoa; they are no longer found on Nukuoro Atoll or Pohnpei.

2.2.3 The modern period: 2000–present

Over the last 20 years, resources for Nukuoro language and culture have increasingly used digital technologies to streamline the creation and access of these materials. Compared to documentation efforts in the previous two eras, resources created in the modern period involve a broader range of stakeholders and organizations, including Nukuoro community members, the local and state government, art historians, local non-profit organizations, and academic linguists.

Several resources were created by Nukuoro people to use the language in new domains and publicly celebrate Nukuoro language and culture. In the domain of religion, a team of Nukuoro translators led by Betty Amon created a Nukuoro translation of the New Testament in the early 2000s, so that they could read the Bible in their own language; the team recently completed a translation of the Old Testament, which was officially printed and dedicated in 2023. Nukuoro is also now used on social media: in the Nukuoro Atoll Facebook group, for example, Nukuoro users in the FSM and elsewhere around the world share and discuss linguistic variation, cultural practices, and oral narratives. On Pohnpei, the Nukuoro municipal government hosts a yearly Cultural Day, which is typically held in late June, to showcase traditional clothing, dances and chants, drumming, singing, weaving, carving, house- and canoe-building, food, and the sharing of cultural knowledge.

Resources created in previous eras have been adapted to make them more accessible for a modern audience. In 2013, a group of art historians at the Beyeler Foundation in Germany put together a collection of materials related to the Nukuoro *tino idu* sculptures (Kaufmann & Wick 2013), which were collected by German explorers (including Kubary and Jeschke) and deposited in museums around the globe. While this collection focuses primarily on aspects of the sculptures themselves, it also provides translations and contextualization of the early German sources, which were previously only available in German, as well as reproductions of images and figures only available in print archival material. Relevant chapters of this volume include Jeschke (1913), an English translation of Jeschke's account, and Theode-Arora (2013), an overview of German sources on Nukuoro.

The modern period also sees involvement from several non-profit organizations in Micronesia and the U.S. The Island Research and Education Initiative in Pohnpei, led by Danko Taboroši,

created a set of Nukuoro alphabet flashcards and drafted a Nukuoro phrasebook (Taboroši et al. In prep), which is intended for a non-Nukuoro audience to learn useful terms and phrases. The NGO Pasifika Renaissance, led by executive director Takuya Nagaoka, recorded and published a series of video narratives on their YouTube channel, and in collaboration with the Education Department in Pohnpei, created a Nukuoro history reader in the Nukuoro language (Pohnpei State Department of Education 2022). In 2013, Nukuoro speakers Johnny Rudolph, Maynard Henry, and Kurt Erwin, along with linguists K. David Harrison and Greg Anderson, created the Nukuoro Talking Dictionary, an online dictionary which allows users to hear words pronounced by native speakers. This dictionary is part of a larger collection of online dictionaries hosted by Swarthmore College and the Living Tongues Institute for Endangered Languages, which aim to provide endangered language communities with tools to document their own languages.

2.3 The Nukuoro Documentation Project

This section describes the present and future contributions to Nukuoro documentation and revitalization, which have provided the foundation for the research presented in this dissertation. My work with the Nukuoro community began in 2015 as part of a National Science Foundation Research Experience for Undergraduates (REU), which aimed to train undergraduate students in methods for endangered language documentation.² In this capacity, I connected with Nukuoro speakers Johnny Rudolph, Ruth Rudolph, and Mina Lekka and conducted preliminary language documentation.

After two more visits to Pohnpei in 2016 and 2019, Johnny Rudolph and I created the Nukuoro Documentation Project, a collaborative effort to document and create resources for Nukuoro language and cultural maintenance. To involve more Nukuoro voices in the planning and execution of project activities, we established an executive committee in 2021, whose members on Pohnpei include Benoni Adolph, Itaia Fred, Dagger Soulik, Johnny Rudolph, and Christian Rudolph, and whose members on Nukuoro Atoll include Ray Ezekias and Harson Henry. Two other academics joined the project for a visit to Pohnpei in June 2023: Margaret Asperheim, a master's student in Linguistics at the University of Hawai'i at Mānoa, and Leonie Maurer, a PhD student in Art History at the University of Heidelberg.

Here, I describe many facets of the Nukuoro Documentation Project, including linguistic and cultural documentation, the creation of digital and print resources, such as a Nukuoro Living Dictionary, a website, a YouTube channel, and a bilingual storybook, and the development of community workshops on Nukuoro Atoll and on Pohnpei.

²This research was funded by NSF grant #1461056; PI: K. David Harrison; co-PIs: Brook Danielle Lillehaugen, Theodore B. Fernald; Research Faculty: Gregory D. S. Anderson, Jamie A. Thomas, Jeremy Fahringer; Local host institutions: IREI (Island Research and Education Initiative), Special Education Department FSM.

2.3.1 Language and cultural documentation

The original goal of the project, and the foundation for this dissertation, concerns documentation of the Nukuoro language and traditional knowledge, such as house-building, canoe-building, and basket weaving. All documentary materials are archived in the open-access Nukuoro Field Materials collection (2019-24) in the California Language Archive, which is housed at the University of California, Berkeley.³ This documentation forms the basis for the digital and print resources described in sections 2.3.2 and 2.3.3.

Much of the linguistic documentation was created through elicitation interviews, whose tasks follow existing resources on linguistic elicitation methodology such as Payne (1997), Matthewson (2004), Bowerman (2008), and Bochnak & Matthewson (2015). These interviews were primarily conducted with Johnny Rudolph, Ruth Rudolph, and Mina Lekka, both in person (2015, 2016, 2019) and over Zoom (2020-present; Figure 2.9). Most interviews were conducted with a single speaker at a time, though there are also several elicitation interviews which were conducted with multiple speakers. The primary elicitation tasks were the following:

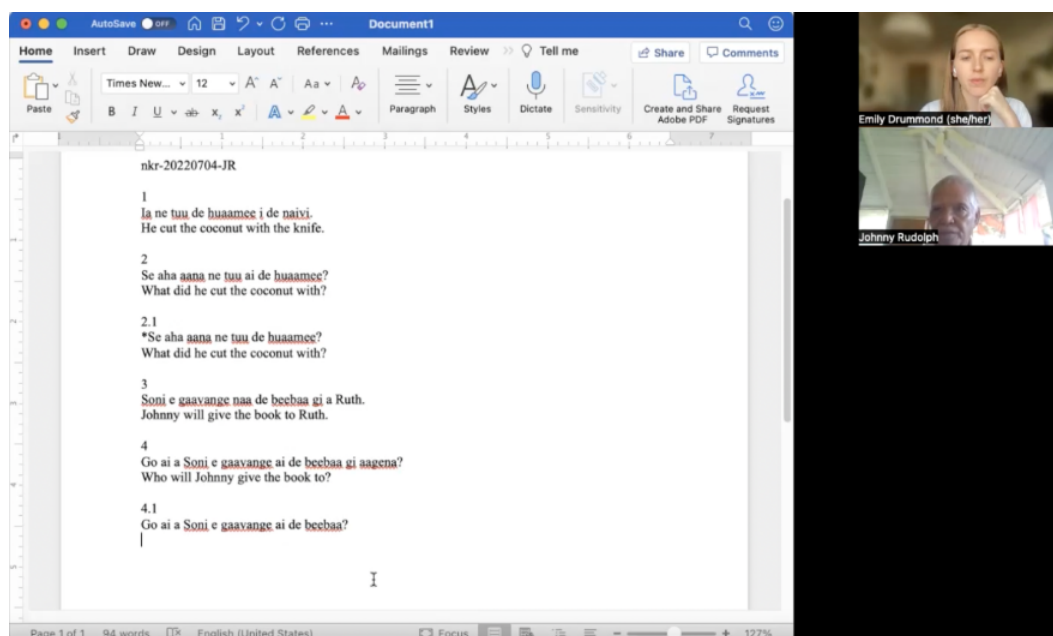

Figure 2.9: Elicitation interview with Emily Drummond and Johnny Rudolph over Zoom

³This collection is available online: <http://dx.doi.org/doi:10.7297/X2M32T4N>.

- (1) Main methods used during elicitation
 - a. Translation from English to Nukuoro, or Nukuoro to English
 - b. Well-formedness judgements of Nukuoro utterances
 - c. Comparison of the well-formedness of two or more Nukuoro utterances
 - d. Acceptability judgements of Nukuoro utterances in a constructed context
 - e. Description of visual stimuli in Nukuoro

The translation tasks in (1a) were used to elicit lexical information in Nukuoro as well as syntactic and semantic information, taking advantage of my native speaker intuitions about English and the way that these meanings are adapted into Nukuoro. The tasks in (1b-c) aim to capture aspects of Nukuoro syntax, which places constraints on the well-formedness of utterances. I mark ill-formed utterances with an asterisk (*) to highlight syntactic combinations which are not possible in the language, regardless of the context they are uttered in. The tasks in (1d-e) aim to capture aspects of Nukuoro meaning, which places constraints on the acceptability of well-formed utterances in particular situations. Utterances which are well-formed but not felicitous in a particular context are presented with a pound sign (#). In elicitation interviews, contexts were constructed and supplied verbally in English, followed by a Nukuoro utterance intended to be spoken in that context, or supplied visually using picture or video stimuli.

Elicitation interviews were supplemented with naturalistic recordings of Nukuoro speech. These recordings included personal histories, traditional oral narratives, procedural descriptions, or interviews conducted by Johnny Rudolph or McKinley Ezekias with other Nukuoro speakers (Figure 2.10). These narrative recordings were then transcribed and translated by myself and Johnny Rudolph using ELAN transcription software. In addition to appearing in the open-access archival collection, these interviews and narratives also appear in several language resources, including the NDP website and YouTube channel (§2.3.2) and in a forthcoming book of Nukuoro narratives (§2.3.3).

Finally, we also carried out documentation of cultural knowledge, including environmental taxonomies, place names, and traditional skills. This documentation was partially accomplished through elicitation interviews and narrative recordings, as well as through photo and video documentation. At the Nukuoro Cultural Day in 2016, for instance, we recorded the process of attaching the outrigger to a single-person canoe, constructing a Nukuoro house, and weaving techniques for baskets and mats (Figure 2.11). These photos and videos were uploaded with consent to the California Language Archive, the NDP website, and the NDP YouTube channel (§2.3.2).

2.3.2 Digital resources

Digital resources for language documentation have several advantages: they are easily changed and updated; they may embed multimedia recordings, such as audio and video; and they are easily accessed from anywhere in the world. We created three digital tools in order to provide simpler, user-friendly interfaces to access to our documentation resources: a Nukuoro Documentation



Figure 2.10: Johnny Rudolph interviews Andelise Fred

Project website,⁴ the primary hub which explains and provides access to all of our resources; a YouTube channel,⁵ which hosts all of our video content; and a Living Dictionary,⁶ which uses software developed by the Living Tongues Institute for Endangered Languages. These resources were developed with the support of several undergraduate research assistants at UC Berkeley: Zhihan Cheng, Shaylan Dias, Stuart Litjen, Molly Pinder, Anjelica Ramos, Samuel Stahl, Crystal Torres, and Cor Zanda.

The NDP website provides a central location to access all available Nukuoro materials, with a focus on stories, photos and videos, and academic documentary materials. The landing page provides background about the project as a whole and includes links to other resources, including the CLA archival collection, the Living Dictionary, and the NDP YouTube channel. The core content contained on the website is organized into four pages: Stories and interviews, Skills and knowledge, Maps, and Resources. The Stories and interviews tab allows users to read and listen to Nukuoro narratives and conversations, which were either recorded between 2015 and 2019 or documented in Carroll's (1980) textual corpus from the 1960s. As shown in Figure 2.12, each story is presented with a title, relevant metadata, and a link to the story's archival file bundle;

⁴<https://www.nukuoro.org/>

⁵https://www.youtube.com/channel/UCtFCUwckvy_55caT7CoQ4Lg

⁶<https://livingdictionaries.app/nukuoro/entries/list>



Figure 2.11: Anelise Fred weaves a coconut palm mat

the story itself is then embedded as a YouTube video (if available) as well as a drop-down menu containing the text transcript and English translation.

The Skills and knowledge tab contains photos and videos of traditional skills, such as house-building, canoe assembly, and the weaving of baskets, mats, roof thatching, and other items. The Map tab provides quick access to new maps of Nukuoro Atoll, created by myself and Johnny Rudolph, as well as older maps that were drawn by Kubary (1900) and Jeschke (1913). The Resources tab provides access to several PDF versions of published work on Nukuoro. The last page of the website acknowledges all participants who contributed to the materials on the site, and allows users to contact us through a Google Form to ask questions or provide feedback.

To support video integration with the NDP website, we also created an NDP YouTube channel, where our video materials can be accessed. These videos currently include several short stories told by Johnny Rudolph and videos of canoe-building, house-building, and palm weaving. For videos that have been transcribed and translated, the Nukuoro transcriptions and English translations of these videos are included in the video caption; in future work, we hope to add Nukuoro-English subtitles to all of our videos for more streamlined viewing.

The Nukuoro Living Dictionary contains more than 6,500 entries and is an updated version of the original Nukuoro Talking Dictionary. The Living Dictionary software, which is hosted by the Living Tongues Institute for Endangered Languages, allows for streamlined editing and

Nukuoro Documentation Project Home · Dictionary · Stories and interviews · Skills and knowledge · Maps · Resources · About & Contact 🔍

Planting coconuts

June 17, 2016 · Kolonia, Pohnpei

Johnny describes how to plant a coconut tree.

Find this in the archive



Transcript: Planting coconuts ▾

Translation: Planting coconuts ▾

①

Figure 2.12: A story told by Johnny Rudolph featured on the NDP website

collaboration while retaining the original functionality of the Talking Dictionary: allowing users to record audio clips alongside dictionary entries in-browser. The Nukuoro Dictionary was created in 2013 and originally contained a few hundred entries, all with corresponding audio clips; from 2013 to 2018, the dictionary expanded to include more than 2,000 entries and 1,000 audio clips, which were added manually from my notes and recordings and from the Nukuoro Lexicon (Carroll & Soulik 1973). In 2020, UC Berkeley undergraduate researcher Stuart Litjen extracted nearly 5,000 additional entries from a tab-delimited text version of the lexicon, which is held at the Kaipuleohone Language Archive at the University of Hawai'i. These entries were checked for duplicates and errors and imported into the Living Dictionary, resulting in the current version which contains 6,524 entries. In future work, we hope to add pictures, grammatical notes, and example sentences to the dictionary as well.

2.3.3 Forthcoming print resources

In addition to creating digital resources, we also plan to create a number of print resources in the Nukuoro language, which will be delivered to the K-8 school on Nukuoro Atoll, the Nukuoro Community Center in Pohnpei, and the Pohnpei Public Library. While digital resources are useful for Nukuoro community members who live in the U.S. or Guam, print resources are more accessible for speakers on Nukuoro Atoll, which has no internet connection, and on Pohnpei, where connectivity is limited. Our goal is that physical resources in the Nukuoro language, such as storybooks and other pedagogical materials, increase the institutional visibility of the Nukuoro language and provide Nukuoro children in particular with more ways to engage with language and culture.

Our first print resource is a bilingual storybook of Nukuoro narratives (Drummond & Rudolph In prep), which includes narratives recorded in our own work and narratives that appear in Carroll (1980). Prior to the creation of this book, our narrative transcriptions existed in various forms, including text files, PDFs, time-aligned audio transcription in ELAN transcription software, and in a corpus in Fieldworks Language Explorer (FLEX); furthermore, the monolingual Nukuoro stories from Carroll (1980) were only available in print in the U.S. In order to make these narratives accessible to Nukuoro speakers in Pohnpei, we compiled these stories into a single document with meaningful context and metadata for each narrative, including broader contextual information, maps, and diagrams. Stories appear side-by-side in Nukuoro and in English, allowing monolingual community members to access the book and facilitating literacy in both languages.⁷ This resource aims to serve a number of functions: it will provide literary material in the Nukuoro language, which is scarce, and it will provide communities with access to documentary materials in print, which are only available in libraries in the U.S. or online. This book is also intended to be the first of a number of interrelated pedagogical language materials, such as picture books for younger children and workbooks for Nukuoro language teaching.

2.3.4 Community programming

A final aspect of the Nukuoro Documentation Project involves the hosting of community gatherings, both in Pohnpei and on Nukuoro Atoll, which allow us to present our language materials to community members and gather ideas and feedback for new materials. In conjunction with the Nukuoro Municipal Government, we have held 6+ community workshops so far, which have been invaluable for the progression of the project and the creation of new digital and print materials.

In 2021, we held two linguistic and cultural revitalization workshops: one five-day workshop held at the Nukuoro Community Center in Pohnpei, FSM, and one five-day workshop held on Nukuoro Atoll. Due to the Covid-19 pandemic, I helped plan these workshops and attended certain parts from Oakland, California via Zoom, while the workshops were hosted in person by Johnny and Ruth Rudolph, with the help of many others. The purpose of these workshops was to provide a space to discuss language maintenance and attitudes, identify key knowledge domains for documentation and revitalization, and teach and learn skills like palm weaving, statue carving, and boat-building. Together, these events invited the participation of over 100 Nukuoro community members living on Nukuoro Atoll and Pohnpei. Across these two workshops, Nukuoro teachers, government officials, and traditional leaders discussed how documentation should be done and what the most important areas of needed documentation are, which was not actually language material: the primary areas of identification were traditional Nukuoro skills, namely house-building, canoe-building, fishing, carving, and palm weaving. These workshops also identified a need to get younger people involved in language work, and voiced interest in developing resources to teach the Nukuoro language.

Building on the success of these workshops, we held several additional community events in June 2023. First, we held a workshop on Nukuoro linguistics, where we taught introductory con-

⁷The interlinearized versions of these narratives can be found in Appendix A of this dissertation.

cepts in linguistics, facilitated discussion of key aspects of Nukuoro grammar and orthography, and trained attendees to techniques in language documentation, including the use of recording equipment. These activities addressed several suggestions from the 2021 workshops, such as increasing community and youth involvement in Nukuoro documentation and creating a space to discuss salient properties of the Nukuoro language. We also held several smaller training workshops, including a training on how to use the Living Dictionary online interface,⁸ ELAN transcription software,⁹ and Bloom, software developed by SIL for the creation of children's books.¹⁰ Smaller trainings like this will continue over the next several years, facilitated by trained community members in Pohnpei.

In the future, we hope to hold a series of carving workshops, where men of all ages will be able to teach and learn the traditional practice of Nukuoro wood carving. There are only a few Nukuoro carvers remaining in the FSM who know how to carve things like canoes, tackle boxes, coconut graters, and Nukuoro deity statues. We hope to provide a number of carving tools and use information from early German sources (e.g., Kubary 1900) to revitalize this skill among younger generations.

2.4 Conclusion

This chapter has outlined some of the geographic, linguistic, and historical context of the Nukuoro language and introduced the Nukuoro Documentation Project. The work I describe here is ongoing and aims to take a holistic view of language documentation and revitalization, incorporating other cultural skills and knowledge into documentary materials. In addition to creating new documentation of Nukuoro language and culture, this project also integrates existing documentation into new resources, which allows these materials to be used by community members who do not have experience working with academic sources or who do not have access to library resources.

⁸<https://livingdictionaries.app/>

⁹<https://archive.mpi.nl/tla/elan/>

¹⁰<https://bloomlibrary.org/create/>

Chapter 3

Nukuoro grammar sketch

This chapter provides a general overview of Nukuoro grammar, with a particular focus on morphosyntax. These aspects of Nukuoro grammar have not been thoroughly documented elsewhere, and are only briefly mentioned in previous descriptive work (Carroll 1965a). While this overview sets the scene for the rest of the dissertation, subsequent chapters are also intended to stand alone, with relevant background information provided in each.

The chapter is structured as follows. In §3.1, I provide a brief overview of Nukuoro phonology and the standardized Nukuoro orthography, which I adopt in this dissertation. §3.2 provides a description of nominal structure, including the pronominal inventory, components of the noun phrase, and nominalization. In §3.3, I describe the basic clause structure of Nukuoro, including word order, transitivity, oblique and adverbial elements, verbal morphology, and inflectional morphology. §3.4 addresses non-standard clause types and clausal phenomena, such as non-verbal predication, comparatives, complementation, adjunct clauses, conjunction, and modality. Finally, §3.5 discusses topics related to information structure, including question formation, focus marking, and topic marking.

3.1 Phonology and orthography

This section provides an overview of the Nukuoro sound system, including the sound inventory of the language and notable (morpho)phonological processes such as fronting of /a:/, lenition, reduplication, and gemination. This section also introduces the Nukuoro orthography, which was developed by community members and missionaries in the early 20th century; this standard orthography will be used throughout the dissertation. The information presented here is informed by the phonetic and phonological description in Carroll (1965a).

3.1.1 Phonemes, phonotactics, and stress

Nukuoro has five phonemic vowel qualities and ten consonant phonemes, including three stops, three nasals, three fricatives, and an alveolar tap. Each of these phonemic categories is contrastive

for length: vowels are contrastive for length in any position, while consonants are generally only contrastive for length in morpheme-initial position (see §3.1.3.4). The full segmental inventory of Nukuoro is provided in Tables 3.1 and 3.2.

	Bilabial	Labiodental	Alveolar	Velar	Glottal
Plosive	p p:		t t:	k k:	
Nasal	m m:		n n:	ŋ ŋ:	
Tap/Flap			r r:		
Fricative		v v:	s s:		h h:

Table 3.1: Nukuoro consonant inventory

	Front	Back
High	i i:	u u:
Mid	e e:	o o:
Low		a a:

Table 3.2: Nukuoro vowel inventory

Long consonants and vowels in Nukuoro are about twice as long as short segments (Carroll 1965a:198) and have the same quality as their short counterparts, with a few notable exceptions. The geminate stops /p t k:/ are often aspirated in addition to being longer in duration. The geminate tap /r:/ is realized as a (pre-)voiced alveolar stop [d] or a (pre-)voiced retroflex stop [ɖ]. The long vowel /a:/ is invariably fronted and realized as [æ:], including across morpheme boundaries (see §3.1.3.1).

Minimal pairs for short and long consonants are provided in (1), from Carroll (1965a:197). Geminate consonants are also derived synchronically by a process of unstressed vowel deletion, which only applies between identical consonants (§3.1.3.4).

(1) Minimal pairs for short and long consonants (Carroll 1965a:197)

[pare]	‘help’	[p:are]	‘steer’
[tau]	‘read’	[t:au]	‘count’
[karo]	fish sp.	[k:aro]	‘look at something at the same time’
[moko]	‘young coconut apple’	[m:oko]	‘insist’
[namu]	‘mosquito’	[n:amu]	‘odor’
[ŋi:]	‘ringing in one ear’	[ŋ:i:]	‘ringing in both ears’
[rapu]	‘mix’	[r:apu]	‘claw’
[varo]	kind of shell	[v:aro]	‘sound of wind against something’
[soro]	‘grate’	[s:oro]	‘erase’
[hano]	‘go’	[h:ano]	‘wash hands’

Many processes in Nukuoro are sensitive to phonological weight, which can be described in terms of moras (units of phonological weight). Short vowels carry one mora, while long vowels carry two moras; short consonants carry no moras, while geminate consonants carry one mora. Moraic structure is useful to characterize Nukuoro phonotactics, stress assignment, and phonological processes.

The minimal content word in Nukuoro must contain at least two moras, and thus can take the shape (C)V(C)V (e.g., *uu* ‘milk’, *dae* ‘reach’, *mamu* ‘fish’). Functional words, by contrast, may consist of a single mora (e.g., *o* ‘genitive marker’, *gu* ‘inchoative aspect’). All possible combinations of adjacent vowels (VV) are attested within a single morpheme except for /uo/ (Table 3.3), and all possible consonant-vowel (CV) combinations are attested except for /vu/ (Carroll 1965a).

Word	Gloss	Word	Gloss
<i>vae</i>	‘foot, leg’	<i>loa</i>	‘ant’
<i>vai</i>	‘water’	<i>goe</i>	‘you (SG)’
<i>mmao</i>	‘farther’	<i>goi</i>	‘still’
<i>mau</i>	‘usual’	<i>mou</i>	‘age group’
<i>tea</i>	‘white’	<i>hua</i>	‘bear fruit’
<i>bei</i>	‘like, similar to’	<i>hue</i>	‘fern’
<i>leo</i>	‘sound’	<i>hui</i>	‘wash’
<i>leu</i>	‘ripe’		

Table 3.3: Possible VV combinations in Nukuoro

Consonant clusters are generally not permitted, although in rapid speech, vowel syncope may create nasal-consonant (NC) clusters that share the same place of articulation (2). Coda consonants are generally not tolerated, including in loan words; loan words that originally have a final consonant are borrowed into Nukuoro with an additional final vowel (3).

- (2) NC clusters created by vowel syncope
 /p:ono+te+apæ:pa/ ‘close+DET+door’ → [p:ontepæ:pa]
 /ana-taiao/ ‘PST-DET.morning’ → [antaiao]
- (3) English loan words
- | | | | |
|--------------------|-------------|----------------|----------|
| <i>kaba</i> | ‘cup’ | <i>boolo</i> | ‘bowl’ |
| <i>teebele</i> | ‘table’ | <i>luumu</i> | ‘room’ |
| <i>biliisimani</i> | ‘policeman’ | <i>suguulu</i> | ‘school’ |

Stress assignment is also weight-sensitive, with primary stress assigned to the penultimate mora of a prosodic word. Secondary stress is assigned to every other mora preceding the primary stress. If one mora of a long vowel is assigned stress, stress is distributed across the entire long vowel. Geminate consonants are never assigned stress, simply by virtue of how they are formed

(§3.1.3.4). Examples of stress assignment are provided in (4), where primary stress is represented by an acute accent (´) and secondary stress is represented by a grave accent (`).

(4) Stress assignment patterns

<i>ea</i> ‘rise’	[é.a]
<i>boo</i> ‘night’	[pó:]
<i>huli</i> ‘turn’	[hú.ri]
<i>gidee</i> ‘see’	[ki.té:]
<i>daane</i> ‘man’	[tá:ne]
<i>dagodo</i> ‘lay’	[ta.kó.to]
<i>duudagi</i> ‘continue’	[tù:.tá.ki]
<i>hagaduu</i> ‘build’	[hà.ka.tú:]
<i>gooluu</i> ‘you (dual)’	[kò:.rú:]
<i>langadala</i> ‘sleeping mat’	[rà.ŋa.tá.ra]

3.1.2 Orthography

In this dissertation, I adopt the standard Nukuoro orthography, which was developed in the early 20th century by the last traditional chief, Leka (Carroll 1965a). This orthography uses the Roman alphabet and is used for all Nukuoro written literature, including the Nukuoro sketch grammar (Carroll 1965a), the Nukuoro lexicon (Carroll & Soulik 1973), and the Nukuoro translation of the Bible. The Nukuoro orthography is provided in Tables 3.4 and 3.5, with the short grapheme presented first, followed by the corresponding long grapheme.

	Bilabial	Labiodental	Alveolar	Velar	Glottal
Plosive	b p		d t	g k	
Nasal	m mm		n nn	ng nng	
Tap/Flap			l ll		
Fricative		v vv	s ss		h hh

Table 3.4: Orthographic consonants

	Front	Back
High	i ii	u uu
Mid	e ee	o oo
Low		a aa

Table 3.5: Orthographic vowels

The orthography maps somewhat straightforwardly to the phonemic inventory, with a few orthographic conventions worth noting. All short segments are represented with a single letter, with the exception of /ŋ/, which is written with the digraph ⟨ng⟩. The tap /ɾ/ is represented by the grapheme ⟨l⟩.¹ Aside from the stops, long segments are represented by doubling the letter used for the short consonant.

The most significant orthographic departure from the phonemic inventory concerns the singleton and geminate stops, which has led to some misconceptions about the voicing specification of the Nukuoro stop inventory. The voiceless singleton stops /p t k/, which are phonetically unaspirated, are written using the graphemes ⟨b d g⟩; their geminate counterparts /p: t: k:/, which are phonetically aspirated, are written using the graphemes ⟨p t k⟩. This convention makes the length distinction in the stop inventory appear to be a voicing contrast; however, it should be noted that all of these stop phonemes are unvoiced, and these two sets of stops are differentiated by length (in addition to aspiration), as is consistent with the rest of the phoneme inventory.

3.1.3 Morphophonological processes

3.1.3.1 /a:/-fronting

The long vowel /a:/ in Nukuoro obligatorily fronts to become [æ:]. This fronting process applies to root-internal /a:/ (5a-c) as well as derived /a:/, which is formed when two /a/ vowels become adjacent at a morpheme boundary (5d-e).

- (5) Fronting of /a:/
- a. /pa:si/ ‘side’ → [pæ:si], *[pa:si]
 - b. /a:he:/ ‘when’ → [æ:he:], *[a:he:]
 - c. /ta:ne/ ‘man’ → [tæ:ne], *[ta:ne]
 - d. /ata-ata/ ‘AUG-light’ → [atæ:ta], *[ata:ta]
 - e. /haka-ara/ ‘CAUS-mat’ → [hakæ:ra], *[haka:ra]

3.1.3.2 Lenition

Nukuoro has several phonological processes that involve the weakening of certain segments, including lenition of /k/, lenition/vocalization of /v/, and final vowel devoicing.

In all positions, the velar stop /k/ may be weakened to a velar fricative, such as the voiceless velar fricative /x/ or the voiced velar fricative /ɣ/ (6). This process appears to be possible in any environment, including at the beginning of a word (6b).

- (6) Lenition of /k/
- a. /haki/ ‘pick (pandanus)’ → [haxi]
 - b. /kai/ ‘so, then’ → [yai]

¹Note that the /ɾ/ in the name of the language itself is represented by ⟨r⟩, following German spelling conventions in the earliest descriptions of the language. Otherwise, the grapheme ⟨r⟩ is not used in Nukuoro.

The labiodental fricative /v/ is often weakened between vowels to the voiced bilabial fricative /β/. In extreme cases, /v/ may also be vocalized to /o/ in these environments (7).

- (7) Lenition of /v/
- a. /k:ivi/ ‘skinny’ → [k:iβi]
 - b. /peɾa:va:/ ‘bread’ → [peɾæ:βæ:], [peɾæ:oæ:]
 - c. /masava:/ ‘time’ → [masoæ:]

Nukuoro also shows a process of final vowel devoicing, which applies to unstressed word-final vowels (8). Vowel devoicing sometimes occurs to the point of near-deletion of the vowel.

- (8) Final vowel devoicing
- a. /hàkatúpu/ ‘pay, honor’ → [hàkatúpu̥]
 - b. /rapóto/ ‘eel’ → [rapótɔ̥]
 - c. /tànjitáŋi/ ‘apologize’ → [tànjitáŋi̥]
 - d. /taha/ ‘place (of someone)’ → [tahḁ]

3.1.3.3 Reduplication

Nukuoro employs two types of reduplication, which copy different amounts of structure: there is a monomoraic reduplicant, which reduplicates a (C)V unit, and a bimoraic reduplicant, which reduplicates a (C)V(C)V unit. These two reduplicants have different grammatical functions. The monomoraic reduplicant is exclusively used for participant number (§3.3.3.1), by which verbs and adjectives show accord with plural nominals, while the bimoraic reduplicant is used for verbal augmentation (§3.3.3.2), including pluractionality, iterativity, duration, or intensification. I gloss these two reduplicants as PL and AUG, respectively.

The monomoraic reduplicant shows several different kinds of reduplication patterns based on the shape of the base. The most common pattern is to reduplicate the initial segment of the verb, creating an initial long vowel (9a-b) or an initial geminate consonant (9c-e). In both cases, I suggest that a monomoraic (C)V unit is reduplicated underlyingly; however, reduplication of a CV segment creates the right environment for vowel syncope to occur (§3.1.3.4), creating an initial geminate consonant instead.

- (9) Initial segment reduplication
- | | | | | |
|----|---------|------------|----------|-----------------|
| a. | [ahe] | ‘return’ | [æ:he] | ‘return (pl)’ |
| b. | [apuru] | ‘sink’ | [æ:puru] | ‘sink (pl)’ |
| c. | [tu:] | ‘cut’ | [t:u:] | ‘cut (pl)’ |
| d. | [seni] | ‘sleep’ | [s:eni] | ‘sleep (pl)’ |
| e. | [pæ:ni] | ‘lie down’ | [p:æ:ni] | ‘lie down (pl)’ |

The plural reduplication pattern is different for verbs of the shape CV(C)V(C)V. Rather than reduplicating the initial consonant, the vowel of the first syllable is lengthened (10a-b). If the consonant that follows the first syllable is a stop, the stop is lengthened as well (10c-d).

(10) First syllable reduplication plus vowel lengthening

- | | | | | |
|----|----------|--------------|-----------|-----------------|
| a. | [savini] | ‘run’ | [sæ:vini] | ‘run (pl)’ |
| b. | [tarea] | ‘be tired’ | [tæ:rea] | ‘be tired (pl)’ |
| c. | [mouri] | ‘be alive’ | [mo:uri] | ‘be alive (pl)’ |
| c. | [matua] | ‘be old’ | [mæ:t:ua] | ‘be old (pl)’ |
| d. | [tokæ:] | ‘be ashamed’ | [to:kæ:] | ‘lay (pl)’ |

Finally, there is an exceptional class of CVCV roots that reduplicate not by copying the initial consonant, but by copying the entire first syllable and lengthening the vowel of that syllable (9). As far as I can tell, this class of verbs cannot be phonologically defined.

(11) Idiosyncratic plural reduplication

- | | | | | |
|----|--------|-----------------|-----------|----------------------|
| a. | [sopo] | ‘rise, jump up’ | [so:sopo] | ‘rise, jump up (pl)’ |
| b. | [huri] | ‘turn’ | [hu:huri] | ‘turn (pl)’ |
| c. | [hiti] | ‘get up’ | [hi:hiti] | ‘get up (pl)’ |

The reduplication patterns for the bimoraic reduplicant are much more uniform: the reduplicant always copies the first two moras of the verb. If the verb only consists of two moras, the entire verb is copied (12a-c); if the verb consists of more than two moras, only the first two moras are reduplicated (12d-f).

(12) Bimoraic reduplication

- | | | | | |
|----|-------------|------------------|-----------------|----------------------------|
| a. | [tapa] | ‘flash of light’ | [tapatapa] | ‘twinkling, flashing’ |
| b. | [ke:] | ‘different’ | [ke:ke:] | ‘completely different’ |
| c. | [oka] | ‘husk a coconut’ | [okaoka] | ‘husk coconuts repeatedly’ |
| d. | [takahi] | ‘step on’ | [takatakahi] | ‘step on repeatedly’ |
| e. | [hæ:ŋota] | ‘fish’ | [hæ:hæ:ŋota] | ‘fish in multiple spots’ |
| f. | [hepo:haki] | ‘fight’ | [hepohepo:haki] | ‘fight frequently’ |

3.1.3.4 Consonant gemination

In addition to having phonemic geminates, Nukuoro also shows a robust synchronic process of consonant gemination. Geminate consonants are formed via a process of unstressed vowel deletion (also known as syncope), where unstressed vowels are deleted between two identical consonants. This process also occasionally occurs between the non-identical consonants /t/ and /s/ to form a geminate /s:/.

Due to the stress assignment patterns and phonotactics of Nukuoro, the environment for consonant gemination is only created at morpheme boundaries via reduplication and affixation. The examples in (13) and (14) show geminate consonants that are created by monomoraic and bimoraic reduplication, respectively. In the following examples, I underline any unstressed vowels in the input that are in the correct environment for deletion to occur.

- (13) Gemination through monomoraic reduplication
- a. /to-tó:/ ‘PL-drop’ → [t:ó:] *[totó:]
 - b. /kē-kéro/ ‘PL-deep’ → [k:éro] *[kekéro]
 - c. /ŋi-ŋísi/ ‘PL-squeak’ → [ŋ:ísi] *[ŋiŋísi]
 - d. /ra-ráva/ ‘PL-finish’ → [r:áva] *[raráva]
 - e. /sú-súra/ ‘PL-appear’ → [s:úra] *[susúra]
- (14) Gemination through bimoraic reduplication
- a. /pòpo-pópo/ ‘AUG-rotten’ → [pòp:ópo] *[pòpopópo]
 - b. /tùtu-tútu/ ‘AUG-set fire’ → [tùt:útu] *[tùtutútu]
 - c. /màmi-mámi/ ‘AUG-delicious’ → [màm:ámi] *[màmimámi]
 - d. /rèrè-rére/ ‘AUG-jump’ → [rèr:ére] *[rèrerére]

Geminate consonants can also form across affix and word boundaries, as shown in (15). There are very few prefixes in Nukuoro, but gemination is possible with the numeral prefix *mada-* ‘face’, which counts by tens, and the causative prefix *haga-*. Consonant gemination also occurs across word boundaries within the same prosodic domain, such as between determiners and the nouns that follow them (15c) or determiners/nouns and preceding prepositional nouns (15d).

- (15) Gemination across segmental affixes and word boundaries
- a. /màta-tóru/ ‘face-three’ (‘thirty’) → [màt:óru] *[màtatóru]
 - b. /hàka-kàukáu/ ‘CAUS-bathe’ → [hàk:àukáu] *[hàkakàukáu]
 - c. /te+táma/ ‘DET+child’ → [t:áma] *[te táma]
 - d. /róto+te+háre/ ‘inside+DET+house’ → [rót:e háre] *[róto te háre]
 - e. /máta+taháŋa/ ‘front+name’ → [mát:ahàŋa] *[máta tahàŋa]

In instances where the same consonant could geminate with its preceding or following segments, gemination must occur in the first environment (16), even though the second environment also creates the right configuration to undergo gemination.

- (16) Preference for leftmost gemination /te+ta:nuŋa/ ‘DET+grave’ → [t:æ:nuŋa]
 /róto+te+ta:nuŋa/ ‘inside+DET+grave’ → [rót:e tæ:nuŋa] *[róto t:æ:nuŋa]

Syncope can also occur between two non-identical coronals to form a geminate /s:/. This gemination has been lexicalized in the word *massiva* ‘ninety’, so the non-geminated form **masiva* is ungrammatical (17a). In other cases, such as gemination between the determiner *de* and nouns beginning with /s/, gemination to form /s:/ is optional (17b).

- (17) Gemination of non-identical coronals
- a. /màta-síva/ ‘face/ten-nine’ → [màs:íva] *[màtasíva]
 - b. /te+sìŋiriti/ ‘DET+shirt’ → [s:ìŋiriti], [te sìŋiriti]

3.2 Nouns

This section describes nominals in Nukuoro, including pronouns, proper nouns, and common nouns. All nominals in Nukuoro can be either unmarked or genitive, where genitive marking is

found on possessor arguments (§3.2.8), subjects of relative clauses (§3.2.9), and subjects of nominalized clauses (§3.2.10). All other arguments, including all core arguments of matrix clauses, appear in an unmarked form.

Elements within the noun phrase generally follow the order in (18), where adjectives and numerals may appear in any order with respect to each other.

(18) Determiner - Noun - { Adjectives / Numerals } - Relative Clause - Demonstrative

Nukuoro nouns are underspecified for number (i.e., general number; Corbett 2000:9): the forms of nouns themselves are invariant for plurality. Number in the noun phrase is instead marked on determiners (§3.2.3) and reflected on adjectives via participant number (§3.2.4).

3.2.1 Pronouns

Nukuoro has two sets of pronouns, unmarked pronouns and genitive pronouns, which mark person, number, and clusivity. Nukuoro shows a three way distinction for number, including singular, dual (exactly two), and plural (three or more). First person dual and plural pronouns distinguish between inclusive and exclusive forms. There are no dedicated reflexive pronouns in the language.

The basic set of unmarked pronouns is provided in Table 3.6. The dual and plural pronouns appear to be created from smaller meaningful units, including the roots *daa* ‘1INCL’, *maa* ‘1EXCL’, *oo* ‘2’, and *laa* ‘3’, the suffixes *-deu* ‘PL’ and *-u* ‘DU’, and the prefix *gi-*, which marks all dual and plural pronouns. In quick speech, this *gi-* prefix is sometimes dropped, though in careful speech it is obligatory.

		SG	DU	PL
1st	INCL	au/ngau	gidaau	gidaadeu
	EXCL		gimaau	gimaadeu
2nd		goe/koe	gooluu	goodou
3rd		ia	gilaau	gilaadeu

Table 3.6: Unmarked pronouns

3rd person pronouns are exclusively used for animate 3rd persons; inanimate 3rd person pronouns are typically null (19a).² Nukuoro also allows *pro*-drop for arguments which are recoverable in the discourse; 3rd person animate pronouns are often *pro*-dropped (19b).³

²In contexts that generally resist null arguments, such as in focus or coordination contexts, definite descriptions like *de mee* ‘the thing’ or *tangada* ‘the person’ are used for inanimate 3rd person arguments. The 3rd person pronoun *ia* can only be used for inanimates if the referent is anthropomorphized in some way.

³*Pro*-drop of 1st and 2nd person arguments is only variably accepted; if *pro*-drop is possible for 1st and 2nd person pronouns, it seems to occur at a much lower rate than *pro*-drop of 3rd person arguments.

- (19) a. Emily ne hhao de bagede ga llingi ange (***ia**) gi denga manusomo.
 Emily PFV fill.up DET bucket PRSP pour DIR.DIST 3SG to DET.PL plant
 ‘Emily filled up the bucket and poured (it) on the plants.’ (JR-20230302)
 JR: ‘With *ia*, it means you’re pouring yourself on the plants.’
- b. Go ai ne haga-baguu ina (**ia**)?
 COP.FOC who PFV CAUS-fall INA 3SG
 ‘Who pushed him/her?’ (JR-20190605)

The most common form of the 1st singular pronoun is *au*, which appears in all argument positions and focus contexts. There is an alternative form of the pronoun, *ngau*, which is optionally used after a preceding vowel. These two forms can be seen in the same utterance in (20).

- (20) Gai go Dehinealigi e hai mai **au**... e haga-ago-na **ngau**...
 then COP.FOC Dehinealigi IPFV make DIR.PROX 1SG IPFV CAUS-learn-CIA 1SG
 ‘It was Dehinealigi who made me, who commanded me...’ (Liinaa, 11-2, line 20)

The 2nd person singular pronoun has two forms: *goe*, which begins with a singleton /k/, and *koe*, which begins with a geminate /k:/.⁴ *Koe* is used in pre-verbal subject position (21a-b) and focus contexts (21c), while *goe* is used in all post-verbal contexts, including post-verbal subject position (22a), object position (22b), and as the object of a preposition (22c). Note that this alternation does not reflect grammatical role: *koe* and *goe* are both intransitive subjects in (21a) and (22a), yet they appear in a different form based on their position in the clause.

- (21) a. **Koe** gu baguu.
 2SG.K INC fall
 ‘You fell.’ (JR-20190703)
- b. Au e tali [bolo **koe** e kii naa].
 1SG IPFV hope COMP 2SG.K IPFV win IRR
 ‘I hope that you win.’ (JR-20190703)
- c. Go **koe** o Ruth e aloha ai.
 COP.FOC 2SG.K GEN.O Ruth IPFV love OBL
 ‘YOU are the one that Ruth loves.’ (JR-20190703)
- (22) a. Gu baguu laa **goe**?
 INC walk DIST 2SG.G
 ‘Did you fall?’ (JR-20190703)
- b. Mina gu gidee **goe**.
 Mina INC see 2SG.G
 ‘Mina saw you.’ (JR-20190703)
- c. Ruth e aloha i de **goe**.
 Ruth IPFV love PREP DET 2SG.G
 ‘Ruth loves you.’ (JR-20190703)

⁴This alternation only applies to *goe*: for all other /k/-initial pronouns, including all dual and plural pronouns, there is no such alternation.

In prepositional phrases introduced by *i* or *gi*, the singular pronouns *au*, *goe*, and *ia* must be preceded by the determiner *de* (23). It is not possible for *de* to appear before dual or plural pronouns (23c).

- (23) a. Ruth e aloha i *(**de**) **au/goe/ia**.
 Ruth IPFV love PREP DET 1SG/2SG/3SG
 ‘Ruth loves me/you/her.’ (JR-20190703)
- b. Mina gu hedaē adu gi *(**de**) **au/goe/ia**.
 Mina INC meet DIR.MED to DET 1SG/2SG/3SG
 ‘Mina met me/you/her.’ (JR-20190703)
- c. Au ne basa ange gi (***de**(nga)) gilaau/gilaadeu.
 1SG PFV talk DIR.DIST to DET 3DU/3PL
 ‘I talked to them.’ (JR-20230906)

Genitive pronouns are morphologically similar to the unmarked pronouns in the dual and plural paradigms, and have wholly distinct forms in the singular paradigm. Genitive forms fall into two classes, one that is marked with an *a* vowel (“*a*-class”) and one that is marked with an *o* vowel (“*o*-class”). The *a*- and *o*-class genitive paradigms are provided in Tables 3.7 and 3.8, respectively. Generally speaking, *a*-class genitives are used for alienable possession, while *o*-class genitives are used for inalienable possession, which includes possession of body parts, kin terms, parts of wholes, and culturally important items like houses and canoes. The distinction between *a*- and *o*-class genitives is described in more detail in §3.2.8.

When preceded by the singular specific determiner *de* or the singular indefinite determiner *se*, genitive pronouns appear morphologically fused with the determiner, often losing their class-indicating vowel. Class distinctions are only preserved in the singular paradigm, where the /e/ vowel of the preceding determiner is lost. In the dual and plural pronouns, it is typically the class vowel which is lost and the /e/ vowel of the determiner is preserved; in the 1st person inclusive pronouns, this process creates the environment for syncope to occur, creating an initial geminate. The genitive pronouns fused with the determiner *de* are provided in Table 3.9.

Since these forms are created in the context of a preceding determiner *de* or *se*, they are only used with singular possessed nouns and only occur in the pre-nominal position (24). This is the most common position for possessor pronouns, as will be discussed further in §3.2.8.

- (24) a. **d-oo** mogobuna
 DET-2SG.GEN.O grandchild
 ‘your grandchild’ (JR-20230414)
- b. **de-laau** hale
 DET-3DU.GEN house
 ‘their (DU) house’ (JR-20230414)

		SG	DU	PL
1	INCL	agu	adaau	adaadeu
	EXCL	—	amaau	amaadeu
2		au	ooluu	oodou
3		ana	alaa	alaadeu

Table 3.7: *a*-class genitive pronouns

		SG	DU	PL
1	INCL	ogu	odaau	odaadeu
	EXCL	—	omaau	omaadeu
2		oo	ooluu	oodou
3		ono/ona	olaa	olaadeu

Table 3.8: *o*-class genitive pronouns

		SG	DU	PL
1	INCL	dagu/dogu	taau	taadeu
	EXCL	—	demaau	demaadeu
2		dau/doo	dooluu	doodou
3		dana/dono	delaau	delaadeu

Table 3.9: Determiner *de* fused with genitive forms

3.2.2 Proper nouns

Proper names are optionally marked by the ‘personal article’ *a* (Clark 1976; Carroll 1965a), which can only appear before proper names that refer to humans (25). I analyze *a* as a preproprial article (Delsing 1993; Matushansky 2008), which I discuss in more detail in Chapter 7.

- (25) Ia ne basa ange gi (**a**) Ruth.
 3SG PFV talk DIR.DIST to PN Ruth
 ‘S/he talked to Ruth.’

(JR-20190607)

3.2.3 Determiners

Determiners precede nouns and encode definiteness as well as number. Definite determiners show a three-way number distinction (singular, dual, and plural) and can be used for unique, anaphoric, generic, and kind readings. Indefinite determiners only show a two-way number distinction (singular and plural) and are used for specific and non-specific indefinite readings.

Nukuoro also allows nouns to appear with no determiner (i.e., bare) where they are generally interpreted as plural. Bare nouns in Nukuoro can be used for non-specific indefinite readings, as well as generic and kind readings; in object position, bare nouns are often incorporated into the verbal complex.

3.2.3.1 Definite determiners

Definite determiners in Nukuoro make a three-way number distinction: *de* is the singular form (26a), *luu* is the dual form, used for exactly two individuals (26b), and *denga* is the plural form, used for three or more individuals (26c). Nominal number is only marked on determiners and other modifiers, such as adjectives; nouns themselves do not inflect for number.

- (26) a. **De** gauligi ne gage i de nui.
 DET child PFV climb PREP DET COCONUT.tree
 ‘The child climbed the coconut tree.’ (JR-20230414)
- b. **Luu** gauligi ne gage i de nui.
 DET.DU child PFV climb PREP DET COCONUT.tree
 ‘The children (2) climbed the coconut tree.’ (JR-20230414)
- c. **Denga** gauligi ne gage i de nui.
 DET.PL child PFV climb PREP DET COCONUT.tree
 ‘The children (3+) climbed the coconut tree.’ (JR-20230414)

There is an additional plural determiner *dengaa*, which is used for large, uncountable numbers of individuals (27). This number category (‘super plural’ or ‘plural of abundance’) only seems to be distinguished by the definite determiner series.

- (27) a. **dengaa** biini vaaligiligi
 DET.PL.SUP pen small.PL.RED
 ‘the (many) tiny pens’ (ML-20150611)
- b. mouli o **dengaa** manu o Nuguolo
 life GEN.O DET.PL.SUP organism GEN.O Nukuoro
 ‘the life of the (many) plants of Nukuoro’ (Molia, 11-1, line 134)

The singular determiner *de* always undergoes vowel syncope and gemination (3.1.3.4) with nouns that start with *d* [t] (see §3.1.3.4), creating an initial geminate *t* [t:] (28). *De* also optionally undergoes gemination with nouns that start with *s*, creating an initial geminate *ss* (29).

- (28) a. *de + dama > tama* ‘the child’
 b. *de + dolo > tolo* ‘the sugarcane’
 c. *de + dabula > tabula* ‘the lizard’
- (29) a. *de + singilidi > ssingilidi, de singilidi* ‘the t-shirt’
 b. *de + suguulu > ssuguulu, de suguulu* ‘the school’

This gemination process creates an apparent stem alternation in *d*-initial nouns: the singular noun begins with *t* (due to the geminated determiner *de*) while the plural noun begins with *d* (30).

- (30) a. Au ne gidee **taane**.
 1SG PFV see DET.man
 ‘I saw the man.’ (JR-20230414)
- b. Au ne gidee denga **daane**.
 1SG PFV see DET.PL man
 ‘I saw the men.’ (JR-20230414)

De(nga) has several properties that are characteristic of definite determiners. For instance, nominals marked with *de(nga)* cannot appear as complements of existential predicates.

- (31) * E { *de / luu / denga* } gaaduu i duaa haho.
 IPFV DET DET.DU DET.PL dog PREP outside
 Intended: ‘There is/are the dog(s) outside.’ (JR-20200629)

De(nga) can be used to describe parts of previously-introduced wholes (32).

- (32) Gimaadeu ne hagaduu ange dahi hale moo Soni, gai **tahuhu** e vava.
 1PL.EXCL PFV CAUS-stand DIR.DIST one house BEN.O Johnny but DET.roof IPFV leak
 ‘We built a house for Johnny, but the roof leaks.’ (JR-20200629)

De(nga) is used to describe unique referents, like the moon and the sun (33). Note that *Henua-i-lalo* ‘Earth’ in example (33b) acts as a proper noun, and cannot take a determiner.

- (33) a. Go de gau ameligaa ne tae gi **de maasina** i mua.
 COP.FOC DET people American PFV reach.PL to DET moon PREP front
 ‘American people reached the moon first.’ (JR-20200629)
- b. Henua-i-lalo e ngalungalue ma e holi age **de laa**.
 Earth IPFV move.RED and IPFV circle up DET sun
 ‘Earth is moving around the sun.’ (JR-20200629)

Definites that are anaphoric to a previous mention in the discourse are marked by *de(nga)* (34). Anaphoric definites also typically appear with the demonstrative *laa* (35) (see §3.2.7). In these examples, the first mention of the referent is underlined, and the second mention is bolded.

- (34) a. *Soni ne gidee dahi gaaduu ma dahi buusi.*
 Johnny PFV see one dog and one cat.
 ‘Johnny saw a dog and a cat.’
 b. **De buusi** e uliuli ma de maasei.
 DET dog IPFV black and DET small
 ‘The cat was black and small.’ (JR-20200629)
- (35) a. *Gai ia ga helau dahi labodo ga gaav-ange gi lote ama de moni*
 so 3SG PRSP conjure one eel PRSP give-DIR.DIST to inside.DET floater DET canoe
 o de gau laa.
 GEN.O DET people DIST
 ‘He conjured an eel and put it inside the outrigger float of those people’s canoe.’
 b. *Gai ga ssao huu gilaadeu... gai de labodo laa e noho i lote*
 so PRSP go.out when 3PL so DET eel DIST IPFV stay PREP inside.DET
 ama delaadeu moni.
 floater DET-3PL.GEN canoe
 ‘When they left... the eel stayed inside the float of their canoe.’ (Gininga, 10-1, lines
 291-293)

Finally, *de(nga)* can be used for generic (36) and kind readings (37).

- (36) **Denga daane maatua** e vava ngudu.
 DET.PL men old.PL IPFV leak mouth
 ‘Old men are chatty.’ (JR-20230306)
- (37) a. *Thomas Edison ne gidee de hai e hai ai tenggii.*
 Thomas Edison PFV see DET way IPFV do/make OBL DET.lightbulb
 ‘Thomas Edison invented the lightbulb.’ (JR-20230906)
 b. **Denga ulumoni** gu sogoisi.
 DET.PL dolphin INC few
 ‘Dolphins are (becoming) rare.’ (JR-20230306)

3.2.3.2 Indefinite determiners

Nukuoro has two sets of indefinite markers.⁵ The first set, namely the determiners *dahi* (singular) and *hanu* (plural), precede indefinite nominals in argument position; I discuss the properties of *dahi/hanu* in this section. A second set of indefinite markers, namely *se* (singular) and *ni* (plural), create syntactic predicates from nominals; I discuss these predicative indefinites, as well as other

⁵These two sets of indefinite markers in Nukuoro correspond to the two indefinite determiners analyzed by Chung & Ladusaw (2004) in Māori, namely *tētahi* and *he*. In Māori, these two indefinite markers appear in many of the same syntactic contexts (except following prepositions; Chung & Ladusaw 2004:28–30). In Nukuoro, however, *dahi* and *se* indefinites have a complementary distribution: *dahi/hanu* are used for nominal indefinites, while *se/ni* are used for indefinites in predicate position. For this reason, I characterize the distinction between these two indefinite markers as primarily syntactic, with *dahi/hanu* realizing D⁰ and *se/ni* as a kind of copula (§3.4.2).

types of non-verbal predication, in §3.4.2. As I will discuss in §3.2.3.3, Nukuoro also allows bare nouns to have plural, non-specific indefinite interpretations.

The indefinite determiners *dahi* and *hanu* can be used in specific indefinite contexts, where the speaker has a particular referent in mind (38a), as well as non-specific contexts, where the speaker does not have a particular referent in mind (38b).

- (38) a. Nova e hai bodu ange gi **dahi doogidaa**. D-ono ingoo go
 Nova IPFV make spouse DIR.DIST to one doctor DET-3SG.GEN.O name COP.FOC
 John.
 John
 ‘Nova is married to a doctor. His name is John.’ (JR-20200629)
- b. Nova e hai bodu ange gi **dahi doogidaa**, gai au e dee iloo be ia
 Nova IPFV make spouse DIR.DIST to one doctor but 1SG IPFV NEG know C 3SG
 go ai.
 COP.FOC who
 ‘Nova is married to a doctor, but I don’t know who he is.’ (JR-20200629)

Dahi/hanu indefinites are used to introduce nominals in positive existential constructions, as shown in (39).⁶

- (39) a. E **dahi manu lele** i hongade hale.
 IPFV one bird PREP top DET house
 ‘There is a bird on top of the house.’ (JR-20230414)
- b. E **hanu unga** i lote moni.
 IPFV some hermit.crab PREP inside.DET canoe
 ‘There are (some) hermit crabs in the canoe.’ (JR-20200610)

Dahi/hanu indefinites take surface scope with respect to other operators, such as negation: when the indefinite precedes negation, it must take wide scope (40a); when the indefinite follows negation, it must take narrow scope (40b). Nukuoro does not have dedicated indefinite forms that are used under negation (i.e., negative polarity items).

- (40) a. **Dahi dangada tee** gidee de monilele.
 one person PFV.NEG see DET airplane
 ✓ Context 1: There’s one person who didn’t see the plane.
 ✗ Context 2: No one saw the plane. (JR-20200608)
- b. Soni **tee tugi dahi dangada**.
 Johnny PFV.NEG hit one person
 ✓ Context 1: Johnny didn’t hit anyone.
 ✗ Context 2: There’s one person that Johnny didn’t hit. (JR-20200608)

⁶Nominals in negative existential constructions, by contrast, require the predicative indefinites *se/ni* (§3.4.2).

The pattern above cannot be attributed to an asymmetry between subjects and objects: when an indefinite subject remains post-verbal, as in (41), it must take scope under negation, suggesting that scope is sensitive to position, not grammatical role.

- (41) Au ne hano gi dahi modu [tee baguu ai laa **dahi manusomo**].
 1SG PFV go.SG to one islet NEG fall OBL DIST one tree
 ‘I went to an islet where a tree didn’t fall.’
 ✓ Context 1: None of the trees on the islet fell down.
 ✗ Context 2: All the trees on the islet fell down except for one. (JR-20220525)

Dahi indefinites obligatorily take narrow scope in conditional clauses (42), suggesting that they are sensitive to so-called “scope islands”. In other words, *dahi* indefinites do not show exceptional wide scope (Farkas 1981; Fodor & Sag 1982; Abusch 1994; Reinhart 1997), which has been reported for indefinites in a number of languages (e.g., St’át’imcets, Matthewson 1999; Tiwa, Dawson 2020).

- (42) Noo dahi daane gu hano gee i Nukuoro, gai a Ruth e dee malangilangi.
 if one man INC go away PREP Nukuoro then PN Ruth IPFV NEG happy
 ‘If one man leaves Nukuoro, Ruth will not be happy.’ (JR-20200608)
 ✓ Context 1: If any man leaves Nukuoro, Ruth will be sad.
 ✗ Context 2: If a specific man leaves, Ruth will be sad, but any other man can leave.

3.2.3.3 Bare nouns

Nukuoro allows nouns to appear with no determiner (i.e., bare); bare nouns in Nukuoro can have a number of readings, including narrow scope indefinite, generic, and kind readings. In context, bare nouns are generally understood to be plural.

Bare nouns are most often found in object position to indicate plural, non-specific indefinite readings of nominals (43). It is very common for the noun *mee* ‘thing’ to be used as a bare object to indicate a habitual or detransitivized transitive action (44).

- (43) a. Koe e daa **malo** ailaanei.
 2SG IPFV wash clothes today.FUT
 ‘You must do laundry today.’ (lit. ‘You must clothes-wash today.’) (JR-20230414)
- b. Au e malibi i de llanga **gede**.
 1SG IPFV fast PREP DET weave basket
 ‘I am fast at weaving baskets.’ (lit. I am fast at basket-weaving.) (JR-RR-20200505)
- (44) a. Au gu gai **mee**.
 1SG INC eat thing
 ‘I have eaten.’ (lit. ‘I have thing-eaten.’) (JR-20230414)
- b. Au e vele **mee** i laangi alodahi.
 1SG IPFV clear thing PREP day all
 ‘I pull weeds every day.’ (lit. ‘I thing-clear every day.’) (JR-20230414)

Bare indefinite arguments in object position are often incorporated (see §3.3.1.6), in the sense that they appear closer to the verb than objects with determiners: they can appear inside of post-verbal modifiers, like the oblique anaphor *ai*, while objects with determiners must appear outside of post-verbal modifiers (45). I analyze this pattern of object incorporation in Chapter 4, situating the Nukuoro pattern within the context of pseudo noun incorporation in Polynesian more broadly (Massam 2001; Medeiros 2013; Collins 2017).

- (45) a. De-nei de naivi aagu e selesele (*denga) **mamu ai**.
 DET-PROX DET knife 1SG.GEN.A IPFV cut.open DET.PL fish OBL
 ‘This is the knife that I cut open fish with.’ (JR-20220929)
- b. De-nei de naivi aagu e selesele ai (**denga**) **mamu**.
 DET-PROX DET knife 1SG.GEN.A IPFV cut.open OBL DET.PL fish
 ‘This is the knife that I cut open (the) fish with.’ (JR-20220929)

Bare indefinites cannot have wide scope existential readings, as shown in (46); note that this example differs minimally from the example in (40a), where a *dahi* indefinite in pre-verbal subject position shows opposite scopal behavior. The inability of bare indefinites to take wide scope in Nukuoro is consistent with the cross-linguistic picture regarding bare nouns, which generally only permit narrow scope readings (e.g., Dayal 2004; Deal & Nee 2018; Collins 2019; Little 2020; Moroney 2021).

- (46) **Dangada** tee gidee de monilele.
 people PFV.NEG see DET airplane
 ✓ Context 1: No one saw the plane.
 ✗ Context 2: There are some people who didn’t see the plane. (JR-20200608)

Bare nouns can also be used for generic readings (47) as well as kind readings (48).

- (47) **Daane maatua** e vava ngudu.
 men old.PL IPFV leak mouth
 ‘Old men are chatty.’ (JR-20230306)
- (48) **Ulumoni** gu sogoisi.
 dolphin INC few
 ‘Dolphins are (becoming) rare.’ (JR-20230306)

3.2.4 Adjectives

Adjectives in Nukuoro follow the noun that they modify (49).

- (49) Au ne gidee e haa gaaduu **uliuli vaaligi**.
 1SG PFV see IPFV four dog black small.PL
 ‘I saw four small black dogs.’ (JR-RR-ML-20190628)

Adjectives typically show participant number with the noun, marking a singular-plural distinction using suppletion or reduplication; this pattern of participant number is also found on many verbs (see §3.3.3.1).⁷ Several high-frequency adjectives are suppletive in the singular and plural, like ‘small’ (50); many adjectives mark plurality through partial reduplication, which follows the monomoraic reduplication pattern described in §3.1.3.3 (51).

- (50) a. Au ne hagao dahi deebele **maasei**.
 1SG PFV buy one table small.SG
 ‘I bought a small table.’ (JR-20230414)
- b. Au ne hagao hanu deebele **vaaligi(ligi)**.
 1SG PFV buy some table small.PL(.RED)
 ‘I bought some small tables.’ (JR-20230414)
- (51) a. Au ne saabai de gauligi **bangoa**.
 1SG PFV carry DET child exhausted
 ‘I carried the exhausted child.’ (JR-20230414)
- b. Gimaadeu ne saabai denga gauligi **baangoa**.
 1PL.EXCL PFV carry DET.PL child exhausted.PL
 ‘We carried the exhausted children.’ (JR-20230414)

Another class of adjectives uses a reduplicated or longer form in the singular, but a truncated or base form in the plural. This is the case for adjectives that are fully reduplicated in the singular, like *uliuli* (52),⁸ and a handful of idiosyncratic adjectives, like *laanui* (53).

- (52) a. de biini **uliuli**
 DET pen black.SG
 ‘the black pen’ (ML-20150611)
- b. denga biini **uli**
 DET.PL pen black.PL
 ‘the black pens’ (ML-20150611)
- (53) a. de biini **laanui**
 DET pen big.SG
 ‘the big pen’ (ML-20150611)
- b. denga biini **nnui**
 DET.PL pen big.PL
 ‘the big pens’ (ML-20150611)

Adjectives may function as predicates with no additional verbalizing morphology (54); adjectival predicates consist of an adjective directly preceded by an aspect marker (54b). Non-verbal predication is discussed in more detail in §3.4.2.

⁷The fact that number is marked on adjectives but not on nouns is typologically unusual (Corbett 2000), though not unattested: a similar pattern appears for a subset of nominals in Nez Perce, for example (Deal 2016a).

⁸Some adjectives that are fully reduplicated in the singular, such as *bodobodo* ‘short (SG)’, have a plural form which also contains a reduplicated initial consonant, like *podo* ‘short (PL)’.

- (54) a. de hine **looloa**
 DET woman tall
 ‘the tall woman’ (JR-20230414)
- b. Au e **looloa**.
 1SG IPFV tall
 ‘I am tall.’ (JR-20230414)

3.2.5 Numerals

Nukuoro has a base-ten numeral system; the series of base ten numerals is created by adding the prefix *mada-* to the core numeral series. A list of numerals is provided in Table 3.10.

1	dahi	10	madaangahulu	100	llau
2	lua	20	madalua	1000	mano
3	dolu	30	matolu	1 million	loo
4	haa	40	madahaa	10 million	ngaa
5	lima	50	madalima	100 million	muna
6	ono	60	madaono	1 billion	bugi
7	hadu	70	madahadu	10 billion	baga
8	valu	80	madavalu	1 trillion	dumaa de gelegele
9	siva	90	massiva		

Table 3.10: Nukuoro numerals

Complex numerals are formed by conjoining numerals using the coordinator *ma* ‘and’.

- (55) Mee nei go ada numbaa **madalua ma lima**.
 thing PROX COP.FOC picture number twenty and five
 ‘This is picture number twenty-five.’ (JR-20150624, line 74)

Numerals that modify nouns are typically introduced by the imperfective aspect marker *e* (§3.3.7.1), though this marker may be omitted if the numeral appears before the noun (56a). The presence of this aspect marker suggests that numerals are introduced in a kind of (reduced) relative clause, at least historically.⁹ When an overt determiner is present, numerals must appear after the noun (56b): pre-nominal numerals are not permitted with determiners (56c).

⁹When numerals appear after the noun, it is plausible that *e* is marking aspect in a relative clause structure. However, certain properties suggest that this relative clause structure for numerals is not synchronically transparent: no other aspect markers can appear before numerals, including the past imperfective *nogo*, and the numeral can appear before the noun with *e*, something that is not possible for other relative clauses (§3.2.9). For these reasons, the aspectual function of *e* must be somewhat semantically bleached. It’s also possible that *e* has some other function unrelated to aspect, though it’s not clear to me what this function would be.

- (56) a. Au ne gidee (**e**) **haa** gaaduu.
 1SG PFV see IPFV four dog
 ‘I saw four dogs.’ (JR-RR-ML-20190628)
- b. Au ne gidee denga gaaduu **e** **haa**.
 1SG PFV see DET.PL dog IPFV four
 ‘I saw the four dogs.’ (JR-RR-ML-20190628)
- c. Au ne gidee (***e haa**) denga (***e haa**) gaaduu.
 1SG PFV see IPFV four DET.PL IPFV four dog
 Intended: ‘I saw the four dogs.’ (JR-RR-ML-20190628, JR-20230316)

Numerals that appear after the noun can appear in any order with respect to adjectives and possessors (57a-c), but they must appear before demonstratives (57d).

- (57) a. Au ne gidee denga gaaduu uliuli a Soni **e haa** laa.
 1SG PFV see DET.PL dog black.PL GEN.A Soni IPFV four DIST
 ‘I saw Johnny’s four black dogs.’ (JR-RR-ML-20190628)
- b. Au ne gidee denga gaaduu uliuli **e haa** a Soni.
 1SG PFV see DET.PL dog black.PL IPFV four GEN.A Soni
 ‘I saw Johnny’s four black dogs.’ (JR-RR-ML-20190628)
- c. Au ne gidee denga gaaduu **e haa** vaaligiligi a Soni.
 1SG PFV see DET.PL dog IPFV four small.PL GEN.A Johnny
 ‘I saw Johnny’s four small dogs.’ (JR-RR-ML-20190628)
- d. Au ne gidee denga gaaduu uliuli a Soni laa (***e haa**).
 1SG PFV see DET.PL dog black.PL GEN.A Soni DIST IPFV four
 ‘I saw Johnny’s four black dogs.’ (JR-20230316)

Nukuoro numerals typically only allow collective readings, as shown in (58a). In order to have a distributive reading, the distributive morpheme *dagi* must be used in addition to a numeral (58b).

- (58) a. Gilaadeu ne llanga e dolu hagahala.
 3PL PFV weave IPFV three sleeping.mat
 ‘They wove three sleeping mats.’ (JR-20200715)
 ✓: The group wove three mats total.
 ✗: Each person wove three mats.
- b. Gilaadeu ne llanga e **dagi** dolu hagahala.
 3PL PFV weave IPFV DISTR three sleeping.mat
 ‘They wove three sleeping mats each.’ (JR-20200715)
 ✗: The group wove three mats total.
 ✓: Each person wove three mats.

Dagi and its corresponding numeral may also undergo quantifier float: these elements may appear in the post-verbal position, rather than within the nominal (59b). Certain other quantifiers may also undergo float, as discussed in §3.2.6.

- (59) a. **Dagi dahi** haahine ne hulo gi de monilele.
 DISTR one woman PFV GO.PL to DET airplane
 ‘Each of the women went to the airplane.’ (JR-20210526)
- b. Denga haahine laa ne hulo **dagi dahi** gi de monilele.
 DET.PL woman DIST PFV GO.PL DISTR one to DET airplane
 ‘Those women each went to the airplane.’ (JR-20210526)

Distributive readings can also be achieved using the phrase *dahi ma dahi* ‘one by one’, which indicates that each individual participated in an event sequentially (60).

- (60) a. **Dahi ma dahi** haahine laa gu anu.
 one and one woman DIST INC dance
 ‘One by one, those women danced.’ (JR-20210526)
- b. Au ne gaav-ange talogo gi **dahi ma dahi** gauligi laa.
 1SG PFV give-DIR.DIST DET.dalogo to one and one child DIST
 ‘I gave talogo to the children one by one.’ (JR-20210526)
 JR: ‘*Dahi ma dahi* is defining one at a time.’

The same kind of construction can have the noun repeated after each *dahi*, as in (61).

- (61) Au ne llanga **dahi gede ma dahi gede**.
 1SG PFV weave one basket and one basket
 ‘I wove the baskets one by one.’ / ‘I wove basket after basket.’ (JR-RR-ML-20190627)

While non-human nouns do not require a classifier to be counted, human nouns require the human numeral classifier *dogo* in order to combine with a numeral. The human numeral classifier appears between the (optional) aspect marker *e* and the numeral.

- (62) Gaa-mai muuhuu (e) **dogo** haa dangada.
 bring-DIR.PROX please IPFV CL.HUM four person
 ‘Please bring four people.’ (JR-20200608)

The classifier *dogo* is only possible when counting humans: it cannot be used to count inanimate nouns (63a) or animate, non-human nouns (63b).

- (63) a. Au ne gidee e (***dogo**) dolu bule.
 1SG PFV see IPFV CL.HUM three shell
 ‘I saw three seashells.’ (JR-20230420)
- b. Au ne gidee e (***dogo**) dolu gaaduu.
 1SG PFV see IPFV CL.HUM three dog
 ‘I saw three dogs.’ (JR-20230420)

There is an additional, more archaic human numeral classifier *dino*, which counts humans in groups of ten (64a).¹⁰ When using complex numerals, the classifier *dino* appears in place of the prefix *mada-* before the tens-place numeral, and *dogo* appears before the ones-place numeral (64b).

- (64) a. (E) **dino** angahulu daane ne hulo ga haangoda matali Soni.
 IPFV CL.HUM.TEN ten man PFV go.PL PRSP go.fishing with Johnny
 ‘Ten men went fishing with Johnny.’ (JR-20230316)
- b. (E) **dino** haa ma **dogo** haa daane ne hulo.
 IPFV CL.HUM.TEN four and CL.HUM four man PFV go.PL
 ‘Forty-four men came.’ (JR-20230316)
 JR: ‘This would only be spoken by elders.’

In modern speech, *dogo* may be used for all numerals, even those which count ten or more humans (65a). If *dogo* is used with a complex numeral, it precedes the entire complex numeral—it cannot be repeated after the second coordinated numeral (65b).

- (65) a. (E) **dogo** madaangahulu daane ne hulo ga haangoda matali Soni.
 IPFV CL.HUM ten man PFV go.PL PRSP go.fishing with Johnny
 ‘Ten men went fishing with Johnny.’ (JR-20230316)
- b. (E) **dogo** madahaa ma (***dogo**) haa daane ne hulo.
 IPFV CL.HUM forty and four man PFV go.PL
 ‘Forty-four men came.’ (JR-20230316)
 JR: ‘This is more like the younger level of speaking.’

Ordinal numerals (e.g., ‘first’, ‘second’, ‘third’) are formed by placing the determiner *de* before the numeral (66-66b); if the numeral begins with /t/ (orthographic <d>), a geminate consonant is formed (see §3.1.3.4).

- (66) a. **Tahi**, au e lodo e tala de hai o de ango... e daamada ai.
 DET.one 1SG IPFV want IPFV tell DET way GEN.O DET pearl IPFV begin OBL
 ‘First, I want to tell how the pearl began.’ (Drummond et al. 2019: line 6)
- b. Agai a Vave ga haga-ahe ange hogi i **de lua** hanonga...
 then PN Vave PRSP CAUS-return DIR.DIST also PREP DET two time
 ‘And Vave came back a second time...’ (Gininga, 10-1, line 309)

If the ordinal numeral refers to a person, the classifier *dogo* must be used, which always fuses with the preceding determiner *de* (67).

- (67) De-laa ne vange laa gi **togo-lua** dama a Iaidemalo.
 DET-DIST PFV give DIST to DET.CL.HUM-two child GEN.A Iaidemalo
 ‘That (name) was given to the second son of Iaidemalo.’ (Gininga, 10-1, line 119)

¹⁰Carroll (1965) describes two other semantically-defined classifiers which provide classification by tens, including the classifier *hua* to count breadfruit, coconuts, and *huaahuu* by tens (e.g., *hualua gaadinga* ‘twenty coconuts’), and *ui* to count roof thatching by tens (e.g., *uilua langadala* = ‘twenty pieces of roofing’). These classifiers are no longer used or recognized by present-day speakers.

3.2.6 Quantifiers

Nukuoro has several quantifiers, which show a wide range of syntactic behavior. In addition to the indefinite quantifiers *dahi* ‘a, one’ and *hanu* ‘some’, which are described in §3.2.3.2, I have identified ten other quantificational elements, which are provided in Table 3.11.

Quantifier	Gloss
<i>alodahi</i>	all
<i>hugadoo</i>	all, maximal
<i>ngaadahi</i>	both
<i>soa</i>	many (for humans)
<i>lagolago</i>	many
<i>llanea</i>	plenty
<i>momo</i>	a few
<i>sogoisi</i>	(too) few
<i>tubu</i>	enough
<i>hia</i>	several, how many

Table 3.11: Nukuoro quantifiers

Most of the quantifiers in Table 3.11 may appear after the noun, in a similar position to numerals and adjectives, and can co-occur with a definite or indefinite determiner (68).

- (68) a. [Denga gauligi suguulu **alodahi**] ne hagaagahi.
 DET.PL child school all PFV call
 ‘All the students called.’ (JR-RR-ML-20190627)
- b. [Luu gaaduu **ngaadahi**] i duaa haho.
 DET.DU dog both PREP outside
 ‘Both dogs are outside.’ (JR-20200629)
- c. [Denga mouli **soa** nei] ga maakau...
 DET.PL live many.HUM PROX PRSP die.PL
 ‘These many living (people) will die...’ (Gininga, 10-1, line 319)
- d. Au ne hhuri mai [hanu mamu **lagolago**].
 1SG PFV pull.in.PL DIR.PROX some fish many
 ‘I pulled in many fish.’ (JR-20230209)
- e. Au ne gai [denga gulu **momo** nei].
 1SG PFV eat DET.PL breadfruit few PROX
 ‘I ate the few breadfruits.’ (JR-20190706)
- f. [Denga daane **sogoisi**] laa gu odi i de hulo.
 DET.PL man few DIST INC empty PREP DET go.PL
 ‘The few men completely left.’ (JR-20210607)

Quantifiers may also appear before the noun (69), like numerals but unlike adjectives. Pre-nominal quantifiers often occur on their own, with no additional determiner.¹¹

- (69) a. [**Soa** dangada] i taonga anaahi.
 many.HUM person PREP DET.party yesterday
 ‘Many people were at the party yesterday.’ (JR-RR-20200507)
- b. [**Lagolago** gaaduu] i duaa haho.
 many dog PREP outside
 ‘Many dogs are outside.’ (JR-20200629)
- c. [**Llanea** mee] ne too iho gi lalo i de uigi nei.
 many thing PFV fall.PL down to below PREP DET week PROX
 ‘Many things fell down this week.’ (JR-20210401)
- d. Au ne gai [**momo** gulu].
 1SG PFV eat few breadfruit
 ‘I ate a few breadfruit.’ (JR-20190706)
- e. Au ne gai [**sogoisi** gulu].
 1SG PFV eat few breadfruit.
 ‘I ate few breadfruits.’ (JR-20190706)

The ability of pre-nominal quantifiers to combine with determiners varies: for instance, *momo* ‘few’ frequently appears between a determiner and a noun (70a), while *sogoisi* ‘(too) few’ cannot co-occur with a determiner when it is pre-nominal (70b).

- (70) a. Au ne gai { hanu / denga } **momo** gulu.
 1SG PFV eat some DET.PL few breadfruit
 ‘I ate some/the few breadfruits.’ (JR-20190706)
- b. Au ne gai { *hanu / *denga } **sogoisi** gulu.
 1SG PFV eat some DET.PL few breadfruit
 ‘I ate (*some/*the) few breadfruits.’ (JR-20190706)

Several quantifiers may appear before the noun in a position that precedes the determiner. This is the case for pre-nominal uses of *alodahi* ‘all’, which must be followed by the plural determiner *denga* (71a). Other quantifiers, like *lagolago* ‘many’, *llanea* ‘plenty’, and *soa* ‘many (for humans)’, can optionally be followed by the singular determiner *de*, which gives rise to a partitive reading of the quantifier (71b-c).

- (71) a. **Alodahi** denga gauligi suguulu ne hagaagahi.
 all DET.PL child school PFV call
 ‘All the students called.’ (JR-RR-ML-20190627)
- b. Au ne gidee { **lagolago** / **llanea** } de gaagoo.
 1SG PFV see many plenty DET chicken
 ‘I saw many/plenty (of the) chickens.’ (ML-HA-20150608)

¹¹*Ngaadahi* ‘both’ is the only quantifier I have found that cannot appear before the noun.

- c. **Soa** tangada i taonga anaahi.
 many.HUM DET.person PREP DET.party yesterday
 ‘Many (of the) people were at the party yesterday.’ (JR-20200507)

Two quantifiers, namely *alodahi* ‘all’ and *ngaadahi* ‘both’ can undergo quantifier float, where the quantifier appears in the post-verbal position instead of within the noun phrase (72). To my knowledge, other quantifiers cannot undergo float to this position.

- (72) a. Denga gaadinga gu odi **alodahi** i de gai.
 DET.PL coconut INC empty all PREP DET eat
 ‘The coconuts were all completely eaten.’ (JR-20210607)
- b. Ia ga hai bodu **ngaadahi** ange gi Gaubogo ma d-ono daina...
 3SG PRSP make spouse both DIR.DIST to Gaubogo and DET-3SG.GEN.O sibling
 ‘He was going to marry both Gaubogo and her sister..’ (Ele, 13-10, line 32)

In addition to appearing as nominal modifiers, most quantifiers can also appear in predicate position with no additional verbalizing morphology (73). This behavior is shared with adjectives, which may freely act as predicates or nominal modifiers (§3.2.4).

- (73) a. Agu beebaa e { **llanea / lagolago** }.
 1SG.GEN.A book IPFV plenty many
 ‘I have many books.’ (lit. ‘My books are plenty/many.’) (JR-20200706)
- b. (E) dolu gulu e { **tubu / sogoisi** }.
 IPFV three breadfruit IPFV enough few
 ‘Three breadfruits is enough / (too) few.’ (JR-20190706)
- c. Gilaadeu ne **soa**.
 3PL PFV many.HUM
 ‘They (the men) were many.’ (Gininga, 10-1, line 60)

The quantifier *hia* ‘several’ behaves like a numeral (§3.2.5) in several respects: it is generally preceded by an aspect marker whether it precedes or follows a noun (74), and it also requires the classifier *dogo* when quantifying over humans (75).

- (74) Gimaadeu ne gaa-mai **e hia** ngago.
 1PL.EXCL PFV bring-DIR.PROX IPFV several egg
 ‘We collected a few eggs.’ (JR-20190704)
- (75) E maua naa goe i de gaa-mai muuhuu e **dogo hia** dangada gi
 IPFV be.able IRR 2SG PREP DET bring-DIR.PROX please IPFV CL.HUM several people SBJV
 bale-a mai gidaau?
 help-CIA DIR.PROX 1DU.INCL
 ‘Can you bring a few people to help us?’ (JR-20200608)

Hia can also be used as an interrogative predicate, where it means ‘how many’ (76).

- (76) Mamu aau ne hudi e **hia**?
 fish 2SG.GEN.A PFV pull.in IPFV how.many
 ‘How many fish did you pull in?’ (JR-20200527)

3.2.7 Demonstratives

Nukuoro has a three-way deictic system, which distinguishes between proximal, medial, and distal deixis. This three-way deictic system is reflected by the demonstrative system, described here, as well as the directional system, which distinguishes motion toward these three loci (§3.3.5).

The three demonstrative particles in Nukuoro are *nei* ‘proximal (by speaker)’, *naa* ‘medial (by addressee)’, and *laa* ‘distal (away from speaker and addressee)”; these particles can be used as nominal modifiers or verbal modifiers, and can combine with other elements to form demonstrative pronouns and locational pronouns. When used as nominal modifiers, demonstrative particles appear at the end of the noun phrase and describe a nominal’s location with respect to the speaker and/or addressee (77). Demonstrative particles usually co-occur with a definite determiner, which appears before the noun.

- (77) a. Au ne noho i de hagahala **nei**.
 1SG PFV sit PREP DET sleeping.mat PROX
 ‘I sat on this sleeping mat (by me).’ (JR-20230414)
- b. Gaa-mai de hagahala **naa**.
 give-DIR.PROX DET sleeping.mat MED
 ‘Give me that sleeping mat (by you).’ (JR-20230414)
- c. Ia ne seni i de hagahala **laa**.
 3SG IPFV sleep PREP DET sleeping.mat DIST
 ‘S/he slept on that sleeping mat (away from both of us).’ (JR-20230414)

Demonstrative particles must appear after adjectival or numeral modifiers (78a), possessors (78b) and relative clauses (78c).

- (78) a. Au e gai naa denga mamu (***nei**) mmoa tea e dolu **nei**.
 1SG IPFV eat IRR DET.PL fish PROX cooked white IPFV three PROX
 ‘I ate these three cooked white fish.’ (JR-RR-ML-20190628)
- b. Gaa-mai de beebaa (***naa**) a Soni **naa**.
 give-DIR.PROX DET book MED GEN.A Johnny MED
 ‘Bring me Johnny’s book (by you).’ (JR-20230414)
- c. Duuduu taagoli (***laa**) aagu ne dada **laa**.
 cut.RED DET.taro DIST 1SG.GEN.A PFV pull DIST
 ‘Cut that taro (over there) that I picked.’ (JR-20230414)

Demonstrative particles can also be used as verbal modifiers, where they are used for temporal deixis rather than spatial deixis: *nei* indicates present tense, *naa* indicates irrealis or future tense,

and *laa* indicates past tense (79). Temporal uses of demonstratives are described in more detail in §3.3.7.2.

- (79) a. Au e dunu **nei** denga mamu.
1SG IPFV cook PRES DET.PL fish
'I'm cooking the fish (now).' (JR-20230414)
- b. Au e dunu **naa** denga mamu.
1SG IPFV cook IRR DET.PL fish
'I will cook the fish.' (JR-20230414)
- c. Au ne dunu **laa** denga mamu anaahi.
1SG PFV cook PST DET.PL fish yesterday
'I cooked the fish yesterday.' (JR-20230414)

Demonstrative pronouns (e.g., 'this', 'that') are formed by combining the demonstrative with a preceding singular determiner *de* (80) or a plural prefix *aa-* (81).

- (80) a. **Dee-nei** d-ogu hale.
DET-PROX DET-1SG.GEN.O house
'This is my house.' (JR-20230414)
- b. **Dee-naa** d-au dama.
DET-MED DET-2SG.GEN.A child
'That (by you) is your child.' (JR-20230414)
- c. **De-laa** de hale daumaha.
DET-DIST DET house church
'That (over there) is the church.' (JR-20230414)
- (81) a. **Aa-nei** agu dama.
PL-PROX 1SG.GEN.A child
'These are my children.' (JR-20230414)
- b. **Aa-naa** oo moni.
PL-MED 2SG.GEN.O canoes
'Those (by you) are your canoes.' (JR-20230414)
- c. **Aa-laa** olaadeu hale.
PL-DIST 3PL.GEN.O house
'Those (away from both of us) are their houses.' (JR-20230414)

Locational pronouns (e.g., 'here', 'there') are formed by adding *ki-* to each of the demonstratives. When used as oblique arguments, they must be preceded by a preposition *i* or *gi* (82).

- (82) a. Seese mai gi **kinei**.
walk DIR.PROX to here
'Walk toward here (by me).' (JR-20230414)

- b. Au ga seese adu gi **kinaa**.
 1SG PRSP walk DIR.MED to there.MED
 ‘I’m going to walk toward there (by you).’ (JR-20230414)
- c. Ia ne seese ange gi **kilaa**.
 3SG PFV walk DIR.DIST to there.DIST
 ‘He walked toward there (away from both of us).’ (JR-20230414)

3.2.8 Possession

Possessors in Nukuoro appear in genitive case, which is either marked by a preceding genitive particle or a genitive pronoun. Genitive marking is also found on subjects of relative clauses (§3.2.9) and subjects of nominalized clauses (§3.2.10).

The position of the genitive argument differs if the possessor is a common/proper noun or a pronoun. Common and proper noun possessors obligatorily appear after the possessed noun and are preceded by a genitive particle *o/a* (83a-84a); it is impossible for common and proper noun possessors to appear before the possessed noun (83b-84b).

- (83) a. de goobai **o de gauligi**
 DET hat GEN.O DET child
 ‘the child’s hat’ (JR-20230414)
- b. *de **o de gauligi** goobai
 DET GEN.O DET child hat
 Intended: ‘the child’s hat’ (JR-20230414)
- (84) a. de hale **o Soni**
 DET house GEN.O Johnny
 ‘Johnny’s house’ (JR-20230414)
- b. *de **o Soni** hale
 DET GEN.O Johnny house
 Intended: ‘Johnny’s house’ (JR-20230414)

Pronominal possessors use a genitive form that is distinct from the unmarked pronominal paradigm (§3.2.1) and may also appear after the possessed noun (85). Pronominal possessors appear in this position most frequently in genitive relative clauses, which I discuss in §3.2.9.

- (85) denga mogobuna **oogu**
 DET grandchild 1SG.GEN.O
 ‘my grandchildren’ (JR-20230414)

However, pronominal possessors more commonly undergo what I will call *genitive preposing*, appearing in a position between the determiner and the possessed noun (86). In this position, genitive pronouns undergo morphological fusion with certain determiners, namely the singular definite determiner *de* and the singular predicative indefinite *se* (87).

- (86) a. *luu ogu galomada*
 DET.DU 1SG.GEN.O eye
 ‘my (two) eyes’ (JR-20230414)
- b. *dahi olau hale*
 one 3DU.GEN.A house
 ‘one of their (DU) houses’ (JR-20230414)
- (87) a. *d-ono goobai*
 DET-3SG.GEN.O hat
 ‘his/her hat’ (JR-20230414)
- b. *se-laadeu hale*
 COP.SG-3PL.GEN house
 ‘a house of theirs’ (JR-20230414)

Preposed pronominal possessors are incompatible with the plural definite determiner *denga* (88a); when a preposed possessor is used to possess a plural noun, the determiner is obligatorily null (88b).

- (88) a. **denga oo mogobuna*
 DET.PL 2SG.GEN.O grandchild
 ‘your (SG) grandchildren’ (JR-20230414)
- b. *oo mogobuna*
 2SG.GEN.O grandchild
 ‘your (SG) grandchildren’ (JR-20230414)

Nukuoro shows a two-way alienability distinction in possession, which is marked by an *a* or *o* vowel on the genitive argument; I will refer to these two morphological classes as *a*-class and *o*-class genitives, respectively. Generally speaking, alienable possession is used for things that can transfer ownership, like material goods (89), while inalienable possession is used for inherent possession or things that cannot transfer ownership, like body parts, kin terms, inherent characteristics, part-whole relationships, clothing, houses, and canoes (90). For overviews of the Polynesian alienability system, see Wilson (1976a,b), Krupa (1994), Lynch (1997) and Baker (2012); see Drummond (2016) for a more detailed description and analysis of Nukuoro alienability.

- (89) *A*-class possession
- a. *d-agu biini*
 DET-1SG.GEN.A pen
 ‘my pen’
- b. *d-agu bela*
 DET-1SG.GEN.A taro.patch
 ‘my taro patch’ (Drummond 2016:3)

(90) *O*-class possession

- a. **d-ogu** lima
 DET-1SG.GEN.O arm/hand
 ‘my arm/hand’
- b. **d-ogu** damana
 DET-1SG.GEN.O father
 ‘my father’
- c. **d-ogu** looloa
 DET-1SG.GEN.O tall
 ‘my height’

(Drummond 2016:3)

Alienability is a flexible category in Nukuoro: any noun that can take *o*-class possession can also take *a*-class possession, depending on the nature of the relationship between the possessor and the possessee. Possession using an *o*-class genitive reflects a canonical inalienable interpretation, such as the relationship between a person and the house they live in (91a) or a person and their inherent characteristics (92a); however, the same nouns can also be possessed using *a*-class genitives, indicating an agentive or temporary relationship with the possessed noun (91b-92b).

- (91) a. **d-ogu** hale
 DET-1SG.GEN.O house
 ‘my house (that I live in)’
- b. **d-agu** hale
 DET-1SG.GEN.A house
 ‘my house (that I built)’

(Drummond 2016:8)

- (92) a. **d-ono** bodobodo
 DET-3SG.GEN.O short
 ‘his shortness (a permanent characteristic)’
- b. **d-ana** bodobodo
 DET-3SG.GEN.A short
 ‘his shortness (e.g., when hunched over)’

(Carroll 1965a:217)

In a similar way, when creative works are possessed, the use of *o*-class possession indicates that a work is about the possessor (93a-94a), while the use of *a*-class possession indicates that the possessor is the author or owner of the work (93b-93b).

- (93) a. **d-ogu** beebaa
 DET-1SG.GEN.O book
 ‘my book (that is about me)’
- b. **d-agu** beebaa
 DET-1SG.GEN.A book
 ‘my book (that I wrote or bought)’

(Drummond 2016:8)

- (94) a. *de kai o Vave*
 DET tale GEN.O Vave
 ‘the story about Vave’
 b. *de kai a Vave*
 DET tale GEN.A Vave
 ‘Vave’s story (i.e., the one he made up or tells)’ (Carroll 1965a:216)

3.2.9 Relative clauses

Relative clauses in Nukuoro are left-headed: the relative head precedes the relative clause, typically leaving a gap in the canonical position of the relative head. There is no relative pronoun or complementizer. Relative clauses are also used to form content questions (§3.5.1) and focus constructions (§3.5.2), which use a pseudocleft structure. The structure of Nukuoro relative clauses and pseudoclefts is analyzed in more detail in Chapter 5.

Object and oblique relative clauses generally use a genitive relative clause (GRC) strategy, where the pre-verbal subject of the relative clause appears in genitive case (95).

- (95) a. *de gahudi aana ne gidee*
 DET banana 3SG.GEN.A PFV see
 ‘the banana that he saw’ (JR-20190620)
 b. *de masovaa o de gauligi ne saabai ai de gede*
 DET time GEN.O DET child PFV carry OBL DET basket
 ‘the time that the child carried the basket’ (ML-20210917)

As in canonical possession (§3.2.8), pronominal genitive subjects may also undergo preposing, appearing between the determiner and the relative head (96). With certain determiners, namely the singular definite determiner *de* and the predicative indefinite determiner *se*, preposed pronominal genitive subjects may fuse with the preceding determiner (96b).

- (96) a. *luu ana gahudi ne gidee laa*
 DET.DU 2SG.GEN.A banana PFV see DIST
 ‘the (two) bananas that he saw’ (JR-20230427)
 b. *d-ogu masovaa ne daadaa ai de hoe*
 DET-1SG.GEN.O time PFV carve.RED OBL DET paddle
 ‘the time that I carved the paddle’ (JR-20230427)

In addition to GRCs, relative clauses may also be formed using an unmarked strategy, where the subject appears unmarked after the verb. Some speakers allow all subjects of relative clauses to appear post-verbally and unmarked, including transitive subjects (97); other speakers only allow intransitive subjects to appear post-verbally in relative clauses (98).

- (97) a. *de masovaa ne gadagada ai de gauligi*
 DET time PFV laugh OBL DET child
 ‘the time the child laughed’ (ML-20210917)

- b. de masovaa ne saabai ai **de gauligi** de gede
 DET time PFV carry OBL DET child DET basket
 ‘the time that the child carried the basket’ (ML-20210917)
- (98) a. de masovaa ne kada ai **gilaadeu**
 DET time PFV laugh OBL 3PL
 ‘the time that they laughed’ (JR-20190620)
- b. * de masovaa ne saabai ai **au** de gede
 DET time PFV carry OBL 1SG DET basket
 Intended: ‘the time that I carried the basket’ (JR-20190620)
 JR: ‘It’s understandable, but improper. It makes the sentence kind of confusing.’

The unmarked relativization strategy must be used for subject relative clauses; in other words, if the subject itself is relativized, no argument appears in genitive case (99).

- (99) de **hine** ne seese laa gi de hale golea
 DET woman PFV walk DIST to DET house goods
 ‘the woman who walked to the store’ (JR-20230427)

Genitive-marked subjects of relative clauses show the same *a/o* distinction that possessor arguments do. Rather than reflecting alienability, the *a/o* distinction generally tracks transitivity: transitive subjects use *a*-marking (100), while intransitive subjects use *o*-marking (101). This includes subjects of intransitive (101a) and so-called “middle” verbs (101b), discussed in §3.3.1, as well as transitive verbs whose object has undergone incorporation (101c).

- (100) a. de henua hoou **a Gaeuli** ne gidee laa
 DET island new GEN.A Gaeuli PFV see DIST
 ‘the new island that Gaeuli found’ (Gininga, 10-1, line 69)
- b. de masovaa **ana** e hai ai ana hagatau nei
 DET time 3SG.GEN.A IPFV do OBL 3SG.GEN.A arrangement PROX
 ‘the time that he tried to do this arrangement’ (Drummond et al. 2019:157)
- (101) a. de momme **o Logo** e noho ai
 DET place GEN.O Logo IPFV sit/live OBL
 ‘the place where Logo was sitting’ (Gininga, 10-1, line 140)
- b. de masovaa **oogu** ne kino ai i de goe
 DET time 3SG.GEN.O PFV hate OBL PREP DET 2SG
 ‘the time that I hated you’ (JR-20190620)
- c. de masovaa **oogu** ne daadaa mee ai
 DET time 1SG.GEN.O PFV carve thing OBL
 ‘the time that I carved (things)’ (JR-20190620)

Nukuoro shows two restrictions on relative clause formation: transitive subjects and oblique arguments cannot undergo typical relativization. Relativization of a transitive subject requires

the addition of the *-Cia* suffix, where C represents an idiosyncratic consonant associated with a particular root, and/or the particle *ina* (§3.3.4), as shown in (102) and (103).

- (102) a. *tama daane ne pelaaini denga ngago
 DET.child boy PFV fry DET.PL egg
 ‘the boy who fried the eggs’ (JR-20160614)
- b. tama daane ne pelaaini **ina** denga ngago
 DET.child boy PFV fry INA DET.PL egg
 ‘the boy who fried the eggs’ (JR-20160614)
- (103) a. *de gaaduu ne kadi au
 DET dog PFV bite 1SG
 ‘the dog that bit me’ (ML-20210917)
- b. de gaaduu ne **gaadia (ina)** au
 DET dog PFV bite.CIA INA 1SG
 ‘the dog that bit me’ (ML-20210917)

I characterize this restriction as a type of *syntactic ergativity* (Dixon 1994), which describes syntactic operations that treat transitive subjects differently from other arguments; Chapters 6 and 7 of this dissertation develop an analysis of syntactically ergative behavior in Nukuoro.

Nukuoro also shows a restriction on oblique relativization. Relative clauses formed on oblique arguments (i.e., prepositional phrases) require resumption by the oblique anaphor *ai* (§3.3.2.3), which appears in the post-verbal position between verbs and their objects (104-105).

- (104) a. *de naivi aagu e duuagi laa de mamu
 DET knife 1SG.GEN.A IPFV gut DIST DET fish
 ‘the knife that I gut the fish with’ (JR-20230504)
- b. de naivi aagu e selesele **ai** laa de mamu
 DET knife 1SG.GEN.A IPFV cut.open.RED OBL DIST DET fish
 ‘the knife that I gut the fish with’ (JR-20230504)
- (105) a. *tangada a Soni ne gaav-ange laa de beebaa
 DET.person GEN.A Johnny PFV give-DIR.DIST DIST DET book
 ‘the person that Johnny gave the book to’ (JR-20230504)
- b. tangada a Soni ne gaav-ange **ai** laa de beebaa
 DET.person GEN.A Johnny PFV give-DIR.DIST OBL DIST DET book
 ‘the person that Johnny gave the book to’ (JR-20230504)

Finally, in addition to headed relative clauses, Nukuoro allows headless relative clauses, where there is no element at the left edge of the relative clause that acts as the relative head (106).

- (106) a. E llanea [amaadeu ne gai].
 IPFV plenty 1PL.EXCL.GEN.A PFV eat
 ‘We ate plenty.’ (lit. ‘Plenty is (what) we ate.’) (JR-20200527)

- b. De-nei [ogu ne hai hegau ai nei].
 DET-PROX 1SG.GEN.O PFV do work OBL PROX
 ‘This is (what) I have done.’

(Deiao, 12-3, line 144)

3.2.10 Nominalizations

Nukuoro allows verbal elements to be nominalized in two ways: there is a morphological nominalizer *-(Ca)nga*, which typically derives location and manner nominalizations of verbs and adjectives, and a more productive clausal nominalization strategy, which combines a verb-initial, inflectionless clause with the singular determiner *de*.

The nominalizing suffix *-(Ca)nga* forms nouns from verbs; this suffix either takes the form *-Canga*, where C represents an idiosyncratic consonant associated with a particular root (see §3.3.4), or *-nga*. The *-(Ca)nga* suffix appears on many deverbal nominalizations in the language, but is no longer fully productive. Nominalizations with *-(Ca)nga* most commonly refer to the location of an action (107) or the manner of doing an action (108).

- | | |
|---|---|
| <p>(107) a. duu-langa
 stand-NMLZ
 ‘location, position’</p> <p>b. daga-manga
 travel-NMLZ
 ‘path, route’</p> <p>c. daanu-nga
 bury-NMLZ
 ‘grave’</p> | <p>(108) a. seese-nga
 walk-NMLZ
 ‘way of walking’</p> <p>b. hai-nga
 do/make-NMLZ
 ‘way of doing something’</p> <p>c. biigo-nga
 bent-NMLZ
 ‘way of being bent’</p> |
|---|---|

In addition to location and manner nominalizations, *-(Ca)nga* can also result in less predictable nominal meanings, including a particular instance of an action (109a), an event characterized by the action’s frequency (109b), or the result of a particular action, like the fuel that remains unburned after removing the cover of an earth oven (109).

- (109) a. hagadiili-**nga**
 produce.offspring-NMLZ
 ‘pregnancy’
- b. dao-**nga**
 bake-NMLZ
 ‘feast, party’
- c. aau-**nga**
 remove-NMLZ
 ‘unburnt fuel remaining in an earth oven’

Nominalization may also be accomplished by combining a verb-initial clause with the singular determiner *de*. Clauses that are nominalized in this way often act as verbal arguments; they also

frequently appear as complements of restructuring predicates (§3.4.5.3) and second conjuncts of verbal coordinations (§3.4.8.1). Nominalized clauses minimally contain a verb, which cannot appear with aspect marking (110). Clauses that are nominalized this way do not typically use the nominalizing suffix *-(Ca)nga*.

- (110) a. *Ia e duudagi i de dangi.*
 3SG IPFV continue PREP DET cry
 ‘S/he continued to cry.’ (JR-20190604)
- b. *Ia ne maanadu age i de (*e / *ne / *ga) anu.*
 3SG PFV think up PREP DET IPFV PFV PRSP dance
 ‘S/he decided to dance.’ (JR-20230427)

While some authors analyze cognates of *i de* in other Polynesian languages as non-finite inflectional markers (e.g., Bauer 1997), I maintain that these embedded clauses are truly nominalized in Nukuoro. Evidence for nominal structure comes from their case assignment properties: subjects that remain inside the embedded clause are obligatorily assigned genitive case, a hallmark property of clausal nominalization (111).

- (111) *Gu daamada i de sele iho *(a) tama laa de manusomo.*
 INC begin PREP DET chop down GEN.A DET.child DIST DET tree
 ‘The child began to cut down the tree.’ (JR-20210526)

Nominalized clauses may also include verbal arguments and adjuncts, which are obligatorily post-verbal. In nominalized clauses, the subject must appear in genitive case, while objects and adjuncts appear unmarked (112).

- (112) a. *de humai o delaau mogobuna gi olaau daha*
 DET come GEN.O DET-3DU.GEN grandchild to 3DU.GEN.O place
 ‘their grandchild’s coming to their place’ (Gininga, 10-1, line 136)
- b. *de tala ange a de bodu... muna nei gi luu damaahine laa*
 DET tell DIR.DIST GEN.A DET spouse word PROX to DET.DU daughter DIST
 ‘the husband’s telling these words to the two daughters’ (Deiao, 12-3, line 110)

As in possession and relative clause contexts, genitive subject pronouns may undergo preposing to a position between the determiner and the verb, where they may fuse with the preceding determiner (113).

- (113) a. *d-ono humai gi de henua nei*
 DET-3SG.GEN.O come to DET island PROX
 ‘his coming to this island’ (Otto, 11-5, line 27)
- b. *d-ana hai de mee nei*
 DET-3SG.GEN.A do DET thing PROX
 ‘his doing this thing’ (Drummond et al. 2019: 157)

3.3 Verbs and inflection

In this section, I describe verbs, verbal modifiers, and verbal inflection in Nukuoro. First, I address core aspects of verbal structure, including transitivity and argument structure (§3.3.1), oblique elements (§3.3.2), and pluractionality (§3.3.3), followed by a discussion of verbal modification, including the *-(C)ia* suffix and the related particle *ina* (§3.3.4), directionals (§3.3.5), and adverbs (§3.3.6). I close this section with a description of tense, aspect, mood, and negation (§3.3.7).

Like many Polynesian languages, Nukuoro has highly analytic morphology and very little inflection. There is no canonical verbal agreement with nominal arguments, for instance: verbs only inflect for participant number with certain arguments, which is marked via suppletion or reduplication (§3.3.3.1).

3.3.1 Transitivity and argument structure

This section describes transitivity in Nukuoro (§3.3.1.1) as well as valence-altering morphology, namely the passive *-(C)ia/ina* (§3.3.1.2), causative *haga-* (§3.3.1.3), stative *ma-* (§3.3.1.4), and reciprocal *he-* (§3.3.1.5). Nukuoro does not have an applicative or antipassive. I also describe noun incorporation, which yields generic or non-specific interpretations of bare objects (§3.3.1.6).

3.3.1.1 Transitivity

Nukuoro shows five transitivity classes for verbs: *zero transitives*, which take no arguments; *intransitives*, which take a single nominal argument; *middles*, which take a single nominal argument and a prepositional object; *transitives*, which take two nominal arguments; and *ditransitives*, which take two nominal arguments and a prepositional goal. I describe each of these transitivity classes in turn below.

Zero transitive predicates in Nukuoro, such as weather predicates, take no arguments (114); there is no expletive subject in Nukuoro.

- (114) a. (E) *haga-magalili*.
 IPFV CAUS-cold
 ‘It’s cold.’ (ML-JR-20150611)
- b. (E) *malino*.
 IPFV calm.weather
 ‘It’s calm weather.’ (JR-20230427)

Intransitive verbs take a single nominal argument (115); there is no clear distinction between unergative and unaccusative predicates in Nukuoro.

- (115) a. *Ia gu doo iho*.
 2SG INC fall down
 ‘S/he fell (down).’ (JR-20190605)

- b. De gauligi gu anu.
 DET child INC dance
 ‘The child danced.’ (JR-20190624)

Transitive verbs take two nominal arguments (116).

- (116) a. Au gu llingi denga vai.
 1SG INC pour.out DET.PL water
 ‘I poured out the water.’ (JR-20210510)
- b. Tama laa ne doolohi de gaagoo.
 DET.child DIST PFV chase DET chicken
 ‘The child chased the chicken.’ (ML-20210709)

There is an additional class of semi-transitive verbs, called “middles” in the Polynesianist literature (Chung 1978; Seiter 1980), which take a single nominal argument and require the object to be marked by the preposition *i* or *gi* (117).¹² Subjects of middle verbs behave like intransitive verbs for the purposes of syntactic operations, such as participant number (§3.3.3.1), relativization (§3.2.9), and genitive marking in nominalizations (§3.2.10).

- (117) a. Au e aloha i de goe.
 1SG IPFV love PREP DET 2SG
 ‘I love you.’ (JR-20190607)
- b. Denga biliisimani gu daudali ange i denga daane alodahi.
 DET.PL police INC follow DIR.DIST PREP DET.PL man all
 ‘The police followed all the men.’ (JR-20210510)
- c. Ruth gu bole ange gi denga gauligi.
 Ruth INC scold DIR.DIST to DET.PL child
 ‘Ruth scolded the children.’ (JR-20210510)

The class of middles is lexically-defined, containing many verbs of emotion and speech, as well as verbs with less agentive subjects. Table 3.12 provides a list of known middle verbs in Nukuoro, though this list is likely non-exhaustive.

Ditransitive verbs select for two core arguments and a prepositional goal. While it is preferred for the theme object to precede the goal (118a), the object and the prepositional goal may appear in either order (118b). There are no ditransitive verbs in Nukuoro that allow two unmarked objects.

- (118) a. Soni gu gaav-ange dahi biini gi Ruth.
 Johnny INC give-DIR.DIST one pen to Ruth
 ‘Johnny gave a pen to Ruth.’ (JR-20150611)

¹²I use the term “middle” in keeping with the Polynesianist tradition; this use of the term should not be confused with its use in syntactic literature more broadly, where it describes a particular class of derived intransitive constructions (e.g., *The bread cuts easily*).

Verb	Gloss
<i>aloha</i>	love
<i>lodo</i>	want, like
<i>vaasuu</i>	like
<i>kino</i>	hate
<i>hedae (ange)</i>	meet
<i>madaangudu</i>	talk to
<i>basa (ange)</i>	talk to
<i>galo (ange)</i>	look at
<i>gahu</i>	wear
<i>daudali (ange)</i>	follow
<i>bole (ange)</i>	scold
<i>gage</i>	climb
<i>dele</i>	sail

Table 3.12: Middle verbs

- b. Soni gu gaav-ange gi Ruth dahi biini.
 Johnny INC give-DIR.DIST to Ruth one pen
 ‘Johnny gave Ruth a pen.’ (JR-20150611)

Ditransitive themes and goals may appear in any person combination: local (1st and 2nd) persons may act as ditransitive themes with 3rd person goals (119) and local person goals (120). Note that for these particular predicates, it is more felicitous to use a possessed locational noun like *daho* or *too* ‘place (of someone)’ rather than a name or a pronoun directly.

- (119) a. Soni ne kave **au** gi daho Ruth.
 Johnny PFV take 1SG to place.GEN.O Ruth
 ‘Johnny took me to Ruth.’ (lit. ‘Ruth’s place.’) (JR-20230906)
- b. Soni ne gaa-mai **goe** gi too Ruth.
 Johnny PFV bring-DIR.PROX 2SG to DET.place Ruth
 ‘Johnny brought you to Ruth.’ (lit. ‘Ruth’s place’) (JR-20230906)
- (120) a. Soni ne gaa-mai **goe** gi ogu daha.
 Johnny PFV bring-DIR.PROX 2SG to 1SG.GEN.O place
 ‘Johnny brought you to me.’ (lit. ‘my place.’) (JR-20230906)
- b. Soni ne gaa-mai **au** gi oo daha.
 Johnny PFV bring-DIR.PROX 1SG to 2SG.GEN.O place
 ‘Johnny brought me to you.’ (lit. ‘your place.’) (JR-20230906)

3.3.1.2 Passives

Passives are formed using the suffix *-Cia* and/or the post-verbal particle *ina* (§3.3.4). Passive constructions promote the patient to pre-verbal subject position and demote the agent (121-122), which may optionally appear in an oblique phrase marked by the general preposition *i* (122c).

- (121) a. Ia ne haga-dige de hadu.
 3SG PFV CAUS-roll DET stone
 ‘He rolled the stone.’ (ML-20210723)
- b. De hadu gu haga-dige-**lia ina**.
 DET stone INC CAUS-roll-CIA INA
 ‘The stone was rolled.’ (JR-20210401)
- (122) a. Gilaadeu gu gaiaa d-ogu stoosaa.
 3PL INC steal DET-1SG.GEN.O car
 ‘They stole my car.’ (JR-20190628)
- b. D-ogu stoosaa gu gaiaa-**dia ina**.
 DET-1SG.GEN.O car INC steal-CIA INA
 ‘My car was stolen.’ (JR-20190628)
- c. D-ogu stoosaa gu gaiaa-**dia ina** i de gau laa.
 DET-1SG.GEN.O car INC steal-CIA INA PREP DET people DIST
 ‘My car was stolen by those people.’ (JR-20190628)

The Nukuoro passive construction, as well as the function of *-Cia/ina* more broadly, is described and analyzed in Chapters 6 and 7.

3.3.1.3 Causatives

The causative prefix *haga-* appears on intransitive verbs to introduce an agent/causer subject, resulting in a derived transitive verb (123-124). Alternations with *haga-* often correspond to inchoative-causative alternations in English, with *haga-* appearing in the causative (124).

- (123) a. De gaaduu gu noho.
 DET dog INC sit
 ‘The dog sat.’ (ML-20160621)
- b. Lydia gu **haga**-noho de gaaduu.
 Lydia INC CAUS-sit DET dog
 ‘Lydia made the dog sit.’ (ML-20160621)
- (124) a. Gu ssili de langi.
 INC stop DET rain
 ‘The rain stopped.’ (ML-20160621)
- b. De madangi gu **haga**-ssili de langi.
 DET wind INC CAUS-stop DET rain
 ‘The wind stopped the rain.’ (ML-20160621)

Haga- is also lexicalized on a large number of verbs which no longer carry transparently causative meaning (125); these lexicalized *haga-* verbs may or may not be transitive, and may no longer be decomposable into their component parts.

- (125) *haga-* ‘CAUS’ + *saele* ‘wander’ > *hagasaele* ‘think’
haga- ‘CAUS’ + *ili* ‘fan (oneself)’ > *hagaili* ‘slap’
haga- ‘CAUS’ + *mabu* ‘rested’ > *hagamabu* ‘take a break’
haga- ‘CAUS’ + *daahao* ‘???’ > *hagadaahao* ‘play’

Transitive verbs cannot be causativized using *haga-* (126). In order to causativize a transitive verb, the verb *hai* ‘make’ is used as a periphrastic causative, which then takes an embedded subjunctive clause (127). Subjunctive embedded clauses are described in §3.4.5.2.

- (126) a. Soni e daadaa dahi hoe.
 Johnny IPFV carve one paddle
 ‘Johnny is carving a paddle.’ (JR-20230427)
- b. *Au e **haga**-daadaa Soni dahi hoe.
 1SG PFV CAUS-carve.RED Johnny one paddle
 Intended: ‘I made Johnny carve a paddle.’ (JR-20230427)
- (127) a. Ana ne basa ange gi Emily ma Lydia.
 Ana PFV talk DIR.DIST to Emily and Lydia
 ‘Ana talked to Emily and Lydia.’ (ML-20160621)
- b. Soni ne **hai** Ana gi basa ange gi Emily ma Lydia.
 Johnny PFV make Ana SBV talk DIR.DIST to Emily and Lydia
 ‘Johnny made Ana talk to Emily and Lydia.’ (ML-20160621)

3.3.1.4 Statives

The stative/resultative prefix *ma-* is a detransitivizing suffix, which appears on transitive verbs to eliminate the agent argument. The resulting intransitive verb encodes the result state of the transitive verb (128-129). Alternations with *ma-* often correspond to inchoative-causative alternations in English, with *ma-* appearing in the inchoative.

- (128) a. Au gu huge de abaaba.
 1SG INC open DET door
 ‘I opened the door.’ (JR-20160625)
- b. De abaaba e **ma**-huge.
 DET door IPFV STAT-open
 ‘The door is open.’ (JR-20160625)
- (129) a. Gidaau gu oha de hale.
 1DU.INCL INC destroy DET house
 ‘We broke/destroyed the house.’ (JR-20160625)

- b. De hale e **ma**-oha.
 DET house IPFV STAT-destroy
 ‘The house is broken/destroyed.’ (JR-20160625)

There is an asymmetry between causative-inchoative alternations that use *ma*- and those that use *haga*-: inchoatives with *ma*- are obligatorily stative, while bare inchoatives that are causativized by *haga*- may be eventive (123-124).

Stative *ma*- differs from the passive *-(C)ia/ina* in its ability to include a demoted agent. The passive still implies that there was an agent, whereas no such implication exists for the stative: oblique agents are not possible with stative *ma*- (130a), whereas they are possible with passive *-(C)ia/ina* (130b).

- (130) a. De abaaba ne ma-huge (*i Soni).
 DET door PFV STAT-open PREP Johnny
 ‘The door was open (*by Johnny).’ (JR-20230906)
- b. De abaaba ne huuge ina (i Soni).
 DET door PFV open.CIA INA PREP Johnny
 ‘The door was opened by Johnny.’ (JR-20210426)

Impressionistically, the two affixes also differ in the kinds of interpretations they yield: detransitivized verbs created by *ma*- have stative interpretations, while detransitivized forms with *-(C)ia/ina* are generally translated as eventive and/or telic.

3.3.1.5 Reciprocals

Nukuoro has a lexicalized reciprocal prefix *he*-, which appears in lexically reciprocal verbs like *hebagi* ‘fight’ (lit. ‘weapon each other’), *hedae* ‘meet’ (lit. ‘arrive at each other’), *hegide* ‘reunite’ (lit. ‘see each other’), and *hebaa* ‘crowd’ (lit. ‘be close to each other’). Two examples of the lexicalized reciprocal prefix are provided in (131).

- (131) a. Gai a Vave ma d-ono daina daane ga **he**-bagi...
 then PN Vave and DET-3SG.GEN.O sibling male PRSP RCPR-weapon
 ‘So Vave and his brother fought...’ (Ele, 13-10, line 2)
- b. ...gi dee **he**-gide ange ai a Vave gi d-ana dama.
 SBJV NEG RCPR-see DIST OBL PN Vave to DET-3SG.GEN.A child
 ‘...so that Vave would never reunite with his son.’ (Gininga, 10-1, line 296)

Reciprocal meanings are more often communicated using the verb *hagadau* ‘each other’,¹³ which appears before another verb to create a verbal compound (132). Typologically, this construction can be classified as a ‘multiple predicate’ strategy for reciprocal formation (Evans 2008;

¹³The fact that *hagadau* contains the causative prefix *haga*- suggests that it is verbal. According to Besnier (2000:214), the cognate Tuvaluan verb *fakatau* literally means ‘compete, exchange’, which can appear in compounds with literal meanings (i.e., ‘compete at hitting’) or reciprocal meanings. This verb appears to be the source of the Nukuoro reciprocal verb *hagadau* as well; however, the literal meaning of ‘compete, exchange’ is no longer available in Nukuoro.

Nordlinger 2023). The reciprocal construction with *hagadau* is grammatical on its own, but may also optionally include a pronoun in argument position. There is no dedicated reciprocal pronoun.

- (132) a. Mea ma Nui e **hagadau** hagailiili (gilaau).
 Mea and Nui IPFV each.other slap.RED 3DU
 ‘Mea and Nui are hitting each other.’ (JR-20210604)
- b. Mea ma Nui e **hagadau** daudali ange (i gilaau).
 Mea and Nui IPFV each.other follow DIR.DIST PREP 3DU
 ‘Mea and Nui are following each other.’ (JR-20210604)
- c. Mea ma Nui e **hagadau** sisi (ange) denga leda (gi gilaau).
 Mea and Nui IPFV each.other write DIR.DIST DET.PL letter to 3DU
 ‘Mea and Nui write each other letters.’ (JR-20210604)

3.3.1.6 Noun incorporation

Transitive verbs can be detransitivized by incorporating a bare noun object, which results in a generic or non-specific interpretation of the object. Objects canonically appear clause-finally, after any post-verbal adjunct elements like manner adverbs, directionals, or the oblique anaphor *ai* (133). By contrast, incorporated objects appear adjacent to the verb before *ai* (133).

- (133) a. De-laa de hale o tamaahine e tilo ai **denga dama**.
 DET-DIST DET house GEN.O DET.girl IPFV look.after OBL DET.PL baby
 ‘That’s the house where the girl looks after the babies.’ (JR-RR-20200505)
- b. De-laa de hale o tamaahine e tilo **dama** ai.
 DET-DIST DET house GEN.O DET.girl IPFV look.after baby OBL
 ‘That’s the house where the girl babysits.’ (JR-RR-20200505)

Only bare nouns may undergo incorporation: nouns with determiners (134a) or modifiers (134b) cannot be incorporated. I provide an analysis of noun incorporation in Nukuoro in §4.2 of Chapter 4.

- (134) a. *De-laa de hale o tamaahine ne tilo **denga dama** ai.
 DET-DIST DET house GEN.O DET.girl IPFV look.after DET.PL baby OBL
 Intended: ‘That’s the house where the girl looks after the babies.’ (JR-RR-20200505)
- b. *De-laa de hale aagu ne llanga **gede lloa** ai.
 DET-DIST DET house 1SG.GEN.A PFV weave basket long.PL OBL
 Intended: ‘That’s the house where I weave long baskets.’ (JR-20220929)

The noun *mee* ‘thing’ is commonly incorporated to yield a detransitivized or “antipassivized” form of a transitive verb (135).

- (135) Go hee oou nogo gai **mee** ai?
 COP.FOC where 2SG.GEN.O IPFV eat thing OBL
 ‘Where were you eating?’ (ML-JR-20150611)

3.3.2 Oblique elements

3.3.2.1 Prepositions

Nukuoro has a general preposition *i*, which is used for a variety of locational relationships, and a locative preposition *gi* ‘to, toward’, which is used to express motion toward a particular point.

- (136) a. Au e noho **i** **Kolonia**.
 1SG IPFV live PREP Kolonia
 ‘I live in Kolonia.’ (JR-20230427)
- b. Au ne hano sogosogo **gi** **Kolonia**.
 1SG PFV go.SG alone to Kolonia.
 ‘I went to Kolonia alone.’ (JR-20190628)

The general preposition *i* has a wide distribution, subsuming a number of prepositional and grammatical functions; for instance, *i* is used for locations (137a), sources (137b), causers (137c), and demoted agents of passives (137d).

- (137) a. Dahi gaaduu e noho **i** **lote** **hale** **laa**.
 one dog IPFV live PREP inside.DET house DIST
 ‘A dog lives in that house.’ (JR-20190628)
- b. Au ne langona mai **i** **de** **goe**.
 1SG PFV hear DIR.PROX PREP DET 2SG
 ‘I heard (it) from you.’ (JR-20190607)
- c. De abaaba ne ma-huge **i** **de** **madangi**.
 DET door PFV STAT-open PREP DET wind
 ‘The door is open because of the wind.’ (JR-20190628)
- d. De gaadinga gu oga ina **i** **a** **Wihem**.
 DET coconut INC husk INA PREP PN Wihem
 ‘The coconut was husked by Wihem.’ (JR-20190628)

I is also used to introduce nominalized complement clauses (see §3.4.5.3).

- (138) Koe e maua **i** [de tilo d-agu damaahine].
 2SG IPFV be.able PREP DET watch DET-1SG.GEN.A daughter
 ‘You can look after my daughter.’ (JR-20190703)

In addition to *i* and *gi*, Nukuoro also has three other prepositional elements, which introduce comitative, similative, and benefactive arguments. The preposition *madali/matali* ‘with’ introduces comitative arguments (139a-b); I have not found a difference in meaning between *madali* and *matali*. Comitative arguments may also be introduced by *ma* ‘and’ (139c), which is a general coordinator in the language (see §3.4.8.1).

- (139) a. Au e anu **matali** goe.
 1SG IPFV dance with 2SG
 ‘I will dance with you.’ (JR-20190603)

- b. Koe tee han-age **madali** Buasalai?
 2SG PFV go.SG-up with Buasalai
 ‘You didn’t go with Buasalai?’ (Gininga, 10-1, line 44)
- c. Gai luu ono daagami ga loo-adu **ma** luu olaau dao...
 then DET.DU 3SG.GEN.O soldier PRSP come.PL-DIR.MED with DET.DU 3DU spear
 ‘So his two soldiers came with their spears...’ (Gininga, 10-1, line 150)

Similitive arguments are introduced using the preposition *be(i)* ‘like’ (140).

- (140) a. De honu nei e mami **be** ni gaagoo.
 DET turtle PROX IPFV taste like COP.PL chicken
 ‘This turtle tastes like chicken.’ (JR-20160619)
- b. Taina daane o Soni e **bei** donu Bill Murray.
 DET.sibling man GEN.O Johnny IPFV like EMPH Bill Murray
 ‘Johnny’s brother looks just like Bill Murray.’ (JR-20160619)

Benefactive arguments are introduced by the preposition *ma/mo* ‘for’, which takes a genitive-marked nominal as its complement (141); the benefactive preposition shows the same *a/o* vowel alternation that marks alienability on all genitive arguments. In these contexts, the benefactive argument appears with the genitive class that would be used if the argument were a possessor of the noun it follows; see §3.2.8 for more about the distinction between *a-* and *o-*marking.

- (141) a. Au e sala saele dahi hegau **ma-agu**.
 1SG IPFV search around one job BEN.A-1SG.GEN.A
 ‘I am looking for a job for myself.’ (JR-20160614)
- b. Ia ga hadu ange dahi gubu daahili **mo Logo**.
 3SG PRSP compose compose DIR.DIST one phrase song BEN.O Logo
 ‘She would compose a song verse for Logo.’ (Gininga, 10-1, line 143)

Benefactive arguments can only modify nominals; it is not possible to use *mo/ma* to indicate the beneficiary of an action (142a). In cases where an action is performed for someone’s benefit, the beneficiary argument is introduced by the preposition *gi* (142b).

- (142) a. * Au ne huge ange de abaaba **mo/ma Soni**.
 1SG PFV open DIR.DIST DET door BEN.O/A Johnny
 Intended: ‘I opened the door for Johnny.’ (JR-20230906)
- b. Au ne huge ange de abaaba **gi Soni**.
 1SG PFV open DIR.DIST DET door to Johnny
 ‘I opened the door for Johnny.’ (JR-20230906)

3.3.2.2 Locational nouns

Specific locational relationships are expressed using locational nouns, which appear in addition to the general prepositions *i* or *gi*. Table 3.13 provides a list of locational nouns in Nukuoro; some of these nouns are derived from words for body parts, such as *mada* ‘face’ and *dua* ‘back’.

Locational noun	Gloss
<i>honga</i>	on top of
<i>lunga</i>	up, above
<i>lalo</i>	down, below
<i>lodo</i>	inside
<i>mada</i>	face, front
<i>mua</i>	before
<i>dua</i>	back, behind
<i>gaogao</i>	near, beside
<i>luu baasi</i>	around
<i>magavaa</i>	between, among
<i>daho</i>	place (of someone)
<i>too</i>	place (of someone)

Table 3.13: Locational nouns

Locational nouns, which are underlined in the examples in (143), appear between the preposition and the noun. The following noun may appear with genitive marking (143b) or in its unmarked form (143a),¹⁴ and pronouns typically appear as preposed genitives of locational nouns (143c).

- (143) a. Ia gu gage age i tua o de hale.
 3SG INC climb up PREP DET.back GEN.O DET house
 ‘S/he climbed on top of the house.’ (lit. ‘the back of the house’) (JR-20190628)
- b. De beebaa e dagodo i tua de galaasa.
 DET book IPFV lie PREP DET.back DET glass
 ‘The book is behind the glass.’ (JR-20190628)
- c. Au ne langona dahi namu i ogu gaogao.
 1SG PFV hear one mosquito PREP 1SG.GEN.O beside
 ‘I heard a mosquito near me.’ (JR-20230414)

The locational nouns *lodo* ‘inside’ and *mada* ‘front’ obligatorily undergo gemination (§3.1.3.4) with following determiners or nouns that start with *d* (144).

- (144) a. Gilaadeu gu i **lotenga** daanunga.
 3PL INC PREP inside.DET.PL grave
 ‘They are in the graves.’ (JR-20190628)
- b. Denga gauligi e hagadaahao i **mate** hale.
 DET.PL child IPFV play PREP front.DET house
 ‘The children are playing in front of the house.’ (JR-20190703)

¹⁴The genitive marker is typically present in citational or slow speech and omitted in quick speech.

3.3.2.3 Oblique anaphors

Nukuoro has two oblique anaphors *ai* and *aagena*, which stand in for oblique arguments (i.e., prepositional phrases). These anaphors are used in non-argument positions to refer back to elements that were mentioned previously in the discourse, and also appear when oblique elements undergo relativization (§3.2.9), question formation (§3.5.1.2), or focus movement (§3.5.2).

The oblique anaphor *ai* stands in for an entire prepositional phrase and appears between the verb and any post-verbal arguments. *Ai* can be anaphoric to any oblique argument, including goals (145a), instruments (145b), and places/times (145c).

- (145) a. Au gu basa ange **ai** gi Mina.
 1SG INC talk DIR.DIST OBL to Mina
 ‘I talked to Mina about it.’ (JR-20190703)
- b. Denga gauligi e hagadaahao **ai** i duaa haho.
 DET.PL child IPFV play OBL PREP outside
 ‘The children are playing with it outside.’ (JR-20190703)
- c. Au ne dugu **ai** de beebaa.
 1SG PFV put OBL DET book
 ‘I put the book there.’ (JR-20230209)

The anaphor *aagena* is more restricted in its distribution: it appears as the complement of a preposition and is typically only anaphoric to times/locations (146a).¹⁵ *Aagena* can also be doubled by the anaphor *ai* in post-verbal position (146b).

- (146) a. Denga gauligi e hagadaahao i **aagena**.
 DET.PL child IPFV play PREP there
 ‘The children are playing there.’ (JR-20160703)
- b. Ia ne hano **ai** gi **aagena**.
 3SG PFV go.SG OBL to there
 ‘S/he went there.’ (JR-20230427)

Both *ai* and *aagena* can be used as resumptive elements in oblique relativization, which is used in questions and focus constructions as well (3.5). All oblique relative clauses require resumption with *ai* (147); certain oblique elements may also be resumed using *aagena* (148), though this resumption is typically optional. Note that in (147a) and (148a), the verbs *daudali ange* ‘follow’ and *hedae ange* ‘meet’ are middle verbs, which selects for prepositional objects (§3.3.1).

- (147) a. Go ai o de biliisimani ne daudali ange ***(ai)?**
 COP.FOC who GEN.O DET police PFV follow DIR.DIST OBL
 ‘Who did the police follow?’ (ML-20210709)

¹⁵In certain contexts, *aagena* is accepted as a pro-form for (animate) prepositional goals (e.g., (148a)), while in others, it is rejected. It is not clear to me under which circumstances *aagena* can be used for human oblique arguments.

- b. Se aha aana ne tuu *(**ai**) de huaamee?
 COP.SG what 3SG.GEN.A PFV cut OBL DET coconut
 ‘What did he cut the coconut with?’ (JR-20220704)
- (148) a. Go ai oou ne hedaē ange ai (**gi aagena**)?
 COP.FOC who 2SG.GEN.O PFV meet DIR.DIST OBL to them
 ‘Who did you meet (them)?’ (JR-20190703)
- b. Go hee oou ne hano ai (**gi aagena**)?
 COP.FOC where 2SG.GEN.O PFV go.SG OBL to there
 ‘Where did you go (there)?’ (JR-20190703)

3.3.3 Pluractionality

Nukuoro marks two kinds of pluractionality on verbs and adjectives, which both use reduplication: participant number, which reflects the number of participants in an action and reduplicates a single mora; and augmentation, which indicates an iterated or intensified action and reduplicates two moras.

3.3.3.1 Participant number

Many verbs and adjectives show participant number marking, which reflects the plurality of the intransitive subject or the transitive object. Participant number can be marked by suppletion, using a different verb form in the singular and plural (149), or it can be marked by reduplication of an initial segment (150).

- | | |
|---|---|
| <p>(149) a. Ia gu hano.
 3SG INC go.SG
 ‘He went.’</p> <p>b. <u>Gilaadeu</u> gu hulo.
 3PL INC go.PL
 ‘They went.’ (JR-20190531)</p> | <p>(150) a. Au e anu.
 1SG IPFV dance
 ‘I am dancing.’</p> <p>b. <u>Gilaadeu</u> e aanu.
 3PL IPFV dance.PL
 ‘They are dancing.’ (JR-20190603)</p> |
|---|---|

The realization of participant number via reduplication is described in more detail in §3.1.3.3.

Participant number reflects a two-way distinction between singular and plural number, even though the pronominal (§3.2.1) and determiner systems (§3.2.3) in the language use a three-way number distinction for singular, dual, and plural. Dual arguments show plural participant number marking, as shown in (151).

- (151) a. Ia gu noho gi lalo.
 3SG INC sit to under
 ‘He sat down.’ (JR-20190603)
- b. Gilaau gu **nnoho** gi lalo.
 3DU INC sit.PL to under
 ‘They (2) sat down.’ (JR-20190603)

- c. Gilaadeu gu **nnoho** gi lalo.
 3PL INC sit.PL to under
 ‘They (3 or more) sat down.’ (JR-20190603)

A small number of transitive verbs show participant number marking for direct objects (152a), and causativized intransitive verbs may show participant number marking with direct objects as well (152b). However, number marking for direct objects is not obligatory for causativized intransitive verbs, as shown in (153).

- (152) a. Au ne **hudi** mai hanu mamu lagolago.
 1SG PFV pull.in.PL DIR.PROX some fish many
 ‘I pulled in many fish.’ (JR-20230209)
- b. Taholaa... ga haga-**llilo** ai ono niho.
 DET.whale PRSP CAUS-disappear.PL OBL 3SG.GEN.O tooth
 ‘The whale covered its teeth.’ (Gininga, 10-1, line 370)
- (153) a. Denga hadu gu **tige**.
 DET.PL stone INC roll.PL
 ‘The stones rolled.’ (ML-20210723)
- b. Gilaadeu ne haga-**dige** denga hadu.
 3PL PFV CAUS-roll DET.PL stone
 ‘They rolled the stones.’ (JR-20210628)

3.3.3.2 Augmentation

Reduplication for event/predicate augmentation targets two moras, copying the first (C)V(C)V sequence of the base (see §3.1.3.3). Since many bases in Nukuoro are bimoraic, this reduplicant often copies the entire base (154a-b); for words that are longer than two moras, the reduplicant only copies the first two moras of the base (154c-d).

- (154) a. *ahe* ‘return’ → *ahe-ahe* ‘return many times’
 b. *dangi* ‘cry’ → *dangi-dangi* ‘cry a lot, beg’
 c. *hebaa* ‘crowd’ → *heba-hebaa* ‘be crowded’
 d. *magiaa* ‘jealous’ → *magi-magiaa* ‘easily or frequently jealous’

The bimoraic reduplicant is used to convey a number of augmentative meanings, including iteration (155a), duration (155b), and intensification (155c).

- (155) a. Au gu **duuduu** de laagau.
 1SG INC CUT.RED DET stick
 ‘I cut the stick (many times).’ (JR-20190603)
- b. Au nogo **nohonoho** mai tali goe.
 1SG IPFV sit.RED DIR.PROX DET.wait you
 ‘I was sitting (for a long time) waiting for you.’ (JR-20190603)

- c. Gai e dahi daane **madumadua** e gaugau i lausedi...
 then IPFV one man old.RED IPFV swim PREP salt.water
 ‘And there was a (really) old man swimming in the water...’ (Gininga, 10-1, line 290)

3.3.4 The *-Cia* suffix and the particle *ina*

Nukuoro has two reflexes of the Polynesian *-Cia suffix (Chung 1978; Pawley 2001), where C represents a consonant which is lexically selected by the verb root. The reflexes of *-Cia may only attach to transitive verbs, and they appear in agent focus, passive, imperative, and subjunctive contexts. The core claims of this dissertation concern the functions of *-Cia in Nukuoro, which are described and analyzed in more detail in Chapters 6 and 7.

The first reflex of *-Cia is a verbal suffix *-(C)ia*, which can take a variety of lexically-specified forms, including *-a*, *-na*, *-dia*, *-lia*, *-mia*, *-ngia*, and *-sia*. Suffixation with *-(C)ia* often triggers other phonological changes to the root, including vowel lengthening and lack of reduplication. Other *-(C)ia* forms have no suffix at all, but reflect other processes associated with *-(C)ia* suffixation, such as vowel lengthening. These realizations of *-(C)ia* are exemplified in Table 3.14.

Change	Root	Verb + <i>-(C)ia</i>	Gloss
Addition of <i>-(C)ia</i> suffix	<i>hai</i>	<i>hai-a</i>	‘do/make’
	<i>gai</i>	<i>gai-na</i>	‘eat’
	<i>pono</i>	<i>pono-dia</i>	‘close’
	<i>bau</i>	<i>bau-lia</i>	‘figure out’
	<i>danu</i>	<i>danu-mia</i>	‘bury’
	<i>lala</i>	<i>laalaa-ngia</i>	‘roast’
	<i>velo</i>	<i>velo-sia</i>	‘stab’
Root changes with <i>-(C)ia</i>	<i>gage</i>	<i>gaage-a</i>	‘climb’
	<i>tugi</i>	<i>duugi-a</i>	‘hit’
	<i>ssili</i>	<i>siili-a</i>	‘ask’
	<i>dada</i>	<i>daa-ngia</i>	‘pull’
Root changes without <i>-(C)ia</i>	<i>kave</i>	<i>gaavee</i>	‘take’
	<i>tilo</i>	<i>diiloo</i>	‘look at’

Table 3.14: Nukuoro reflexes of *-Cia

The second reflex is a post-verbal particle *ina*, which is invariant in form and can appear with any verb root, including verbs that are already suffixed with *-(C)ia* (156a) and verbs that are invariant for *-(C)ia* (156b). *Ina* is not a suffix, but a free-standing particle, which can be separated from the verb by manner adverbs (157a) and directional particles (157b).

- (156) a. Gilaau gi dee hulo gi daia **ina** a Logo.
 3DU SBJV NEG go.PL SBJV kill.CIA INA PN Logo
 ‘You should not go to kill Logo.’ (Deiao, 12-3, line 60)
- b. De gaadinga gu oga **ina** i de goe.
 DET coconut INC husk INA PREP DET 2SG
 ‘The coconut was husked by you.’ (JR-20190628)
- (157) a. Go ai ne huudia maalie **ina** mai de mamu?
 COP.FOC who PFV pull.in.CIA slowly INA DIR.PROX DET fish
 ‘Who pulled in the fish slowly?’ (JR-20230302)
- b. Doo ange **ina** odaadeu mee.
 fall DIR.DIST INA 1PL.INCL.GEN.O thing
 ‘Pack up our things.’ (Gininga, 10-1, line 192)

-*Cia/ina* morphology appears in four contexts in Nukuoro: transitive subject relative clauses (§3.2.9), which encompasses transitive subject questions and focus constructions; passives (§3.3.1.2); transitive imperatives (§3.4.7); and transitive subjunctive clauses (§3.4.5.2). These four contexts are exemplified below, respectively (158).

- (158) a. Go Mina ne buuludi **ina** ange tamaa gauligi.
 COP.FOC Mina PFV hug INA DIR.DIST DET.child
 ‘It was Mina who hugged the child.’ (JR-20190605)
- b. Soni gu boo-**gia** **ina** mai i dena biliisimani.
 Johnny INC grab-CIA INA DIR.PROX PREP DET.PL police
 ‘Johnny was caught by the police.’ (JR-20190628)
- c. Gooluu doo-**a** **ina** de maduu!
 2DU plant-CIA INA DET mature.coconut
 ‘(You all) plant the mature coconut!’ (Deiao, 12-3, line 133)
- d. Ia ga haga-ago luu ono daagami gi velo-**sia** a Logo.
 3SG PRSP CAUS-learn DET.DU 3SG.GEN.O soldier SBJV stab-CIA PN Logo
 ‘He instructed his two guards to stab Logo.’ (Gininga, 10-1, line 149)

Other common uses of *-*Cia* in related languages (e.g., Samoan) include a transitivizing use, which allows *-*Cia* to attach to middle verbs to create a transitive, and appearance under negation (Mosel & Hovdhaugen 1992). Neither of these uses is found in Nukuoro (159).

- (159) a. *Au e aloha ina Ruth.
 1SG IPFV love INA Ruth
 Intended: ‘I love/adore Ruth.’ (JR-20230504)
- b. Au e **dee** { hudi / *huudia } mai dahi mamu.
 1SG IPFV NEG pull.in pull.in.CIA DIR.PROX one fish
 ‘I didn’t catch a fish.’ (JR-20190701)

In texts recorded in 1966, *-(C)ia/ina* also occasionally appears in verb-initial adjunct clauses, even though they do not transparently have any of the functions of *-(C)ia/ina* described above (160a). These adjunct clauses marked with *-(C)ia* are some of the only places where ergative marking appears in the textual corpus (160b). Ergative marking is no longer used in modern Nukuoro; see §3.4.1 of this chapter and Chapter 7 for a discussion of case marking in older and modern varieties of Nukuoro.

- (160) a. Ga dugu-**a** naa huu goodou de maduu, ga somo.
 PRSP put-CIA IRR when 2PL DET mature.coconut PRSP grow
 ‘When you plant the mature coconut, it will grow.’ (Gininga, 10-1, line 364)
- b. Gai ga dugu-**a** naa huu **e goe**, gai de mamu laa ga malanga.
 then PRSP put-CIA IRR when ERG 2SG so DET fish DIST PRSP depart
 ‘And when you leave (him) there, that fish will depart.’ (Leaba, 11-8, line 112)

3.3.5 Directionals

Nukuoro has several directional particles, which appear after the verb to indicate a direction of motion. The deictic directionals *mai*, *adu*, and *ange* distinguish three degrees of deixis, which is also encoded in the demonstrative system (see §3.2.7); the other two directionals *age* and *iho* encode motion up and down, respectively. Table 3.15 summarizes the directional system of Nukuoro.

Directional	Gloss
<i>mai</i>	proximal (towards speaker)
<i>adu</i>	medial (towards addressee)
<i>ange</i>	distal (away from speaker and addressee)
<i>age</i>	upwards
<i>iho</i>	downwards

Table 3.15: Directionals

Directionals appear as post-verbal modifiers, which intervene between the verb and the object (161). Verbs of motion (e.g., *loo* ‘come’), transfer (e.g., *gaa(v)*- ‘give’, *kave* ‘take’), and speech (e.g., *hai* ‘say’, *ssili* ‘ask’) frequently appear with directionals.

- (161) a. Seesee **mai** gi kinei.
 walk DIR.PROX to here
 ‘Walk (toward me) here.’ (JR-20230414)
- b. Au ga seesee **adu** gi kinaa.
 1SG PRSP walk DIR.MED to there.MED
 ‘I’m going to walk (toward you) over there.’ (JR-20230414)

- c. Ia gu seese **ange** gi kilaa.
 3SG INC walk DIR.DIST to there.DIST
 ‘He walked (away from us) over there.’ (JR-20230414)
- (162) Au ne gage **age** ga lava ga sege **iho** i de nui.
 1SG PFV climb up PRSP finish PRSP slide down PREP DET coconut.tree
 ‘I climbed up and then slid down the coconut tree.’ (JR-RR-20200505)

The deictic directionals *mai*, *adu*, and *ange* can be used to indicate the object/recipient/goal of an action, which can go unexpressed (163a), appear in a prepositional phrase (163b), or appear as the object of the verb (163c).

- (163) a. Au ne tale **adu**.
 1SG PFV touch DIR.MED
 ‘I touched (you).’ (JR-20190607)
- b. Au ne tale **adu** gi de goe.
 1SG PFV tale DIR.MED to DET 2SG
 ‘I touched you.’ (JR-20190607)
- c. Au ne tale **adu** d-oo dua.
 1SG PFV touch DIR.MED DET-2SG.GEN.O back
 ‘I touched your back.’ (JR-20190607)

Verbs and directional particles can also combine to form idiomatic or non-compositional meanings (164), such as *bole ange* ‘scold’ (lit. ‘shake at’) and *doo ange* ‘pack’ (lit. ‘drop at’).

- (164) a. Ruth gu **bole ange** gi denga gauligi.
 Ruth INC shake DIR.DIST to DET.PL child
 ‘Ruth scolded the children.’ (JR-20210510)
- b. Soni e **doo ange** maalie omaadeu mee.
 Johnny IPFV drop DIR.DIST slowly 1PL.EXCL.GEN.O thing
 ‘Johnny packed our things slowly.’ (JR-20230309)

3.3.6 Adverbs

Nukuoro does not have a grammatical class of manner adverbs; instead, adverbial meanings are communicated using verb-adjective compound constructions, where an adjective appears between the matrix verb and any post-verbal particles or objects (165).

- (165) a. Au ne dugu **maalie** ange de beebaa gi hongaa teebele.
 1SG PFV put slow DIR.DIST DET book to top DET.table
 ‘I slowly put the book on the table.’ (JR-20190603)
- b. de momme oogu ne savini **haga-malibi** ai
 DET place 1SG.GEN.O PFV run CAUS-fast OBL
 ‘the place where I ran fast’ (JR-20190621)

- c. de masovaa oogu nogo aloha **mao** ai i de goe
 DET time 1SG.GEN.O IPFV love deep OBL PREP DET 2SG
 ‘the time when I loved you deeply’ (JR-20190621)

Similar adverbial meanings can be communicated by using an adjective as a matrix predicate, followed by an embedded nominalized clause (166a) or a clause chaining construction (166b).

- (166) a. Au e **malibi** i de llanga mee.
 1SG IPFV fast PREP DET weave thing
 ‘I weave quickly.’ (lit. ‘I am fast at weaving.’) (JR-20200505)
- b. Au ne **haga-malibi** ga savini.
 1SG PFV CAUS-fast PRSP run
 ‘I ran quickly.’ (JR-20190621)

Nukuoro does have a class of (nominal) temporal adverbs, such as *anaahi* ‘yesterday’ and *daiiao* ‘tomorrow’; these elements typically appear at the end of a clause, but they can also appear at the beginning of the sentence and between the verb and the object (167).

- (167) (**Anaahi**) au ne dugu ange (**anaahi**) de beebaa gi hongaa teebele (**anaahi**).
 yesterday 1SG PFV put DIR.DIST yesterday DET book to top DET.table yesterday
 ‘I put the book on the table yesterday.’ (JR-20190603)

Many temporal adverbs make a distinction between past and future uses, where future uses of the adverb contain the prefix *a(i)-* and past uses of the adverb contain the prefix *ana(i)-*. For instance, *ai-laa-nei* ‘today (future)’ (‘FUT-sun-prox’) can only be used for events that are happening later today (168a), while *anai-laa-nei* ‘today (past)’ (‘PST-sun-prox’) is used for events that happened earlier today (168b). The same *ana-* prefix can also be found on adverbs like *ana-ahi* ‘yesterday’ (‘PST-fire’), *ana-boo* ‘last night’ (‘PST-night’), and *ana-taiiao* ‘yesterday morning’ (‘PST-DET.morning’).

- (168) a. Au e maua i de hudi dahi mamu **ai-laanei**.
 1SG IPFV be.able PREP DET pull.in one fish FUT-today
 ‘I can catch a fish today.’ (JR-20190531)
- b. Ni aha a Mina ne hai **anai-laanei**?
 COP.SG what GEN.A Mina PFV do PST-today
 ‘What did Mina do today?’ (JR-20190704)

3.3.7 Tense, aspect, mood, and negation

3.3.7.1 Aspect and mood

Nukuoro has several aspectual and/or mood particles that occur between the pre-verbal subject and the verb. These particles and their functions are summarized in Table 3.16.

E is an imperfective aspect marker, which is used in a wide range of contexts but most often in present and future contexts. For present tense readings, *e* may co-occur with the proximal

Particle	Gloss
<i>e</i>	imperfective
<i>ne</i>	perfective
<i>nogo</i>	past imperfective
<i>gu</i>	inchoative
<i>ga</i>	prospective
<i>gi</i>	subjunctive
<i>kana</i>	negative purposive ('lest')
<i>goi</i>	continuative ('still')
<i>tigi</i>	negative continuative ('not yet')

Table 3.16: Aspect/mood particles in Nukuoro

deictic *nei* (169a); for future readings, *e* usually co-occurs with the medial deictic/irrealis marker *naa* (169b). *E* is also licit in past tense contexts, as shown in (169c).

- (169) a. Soni **e** hano (nei) gi de hale golea.
 Johnny IPFV go.SG PROX to DET house goods
 'Johnny is going to the store (now).' (JR-20190708)
- b. Soni **e** hano **naa** gi de hale golea (daiao).
 Johnny IPFV go.SG IRR to DET house goods tomorrow
 'Johnny will go to the store (tomorrow).' (JR-20190708)
- c. Gimaaui gu maatagu i Iaidemalo [**e** hai mai bolo gimaaui gi aahe]...
 1DU.EXCL INC afraid.PL GEN Iaidemalo IPFV say DIR.PROX COMP 1DU.EXCL SBJV return.PL
 'We were afraid of Iaidemalo, who said we should return...' (Gininga, 10-1, line 162)

The imperfective *e* also appears in a variety of other contexts, including with individual-level stative verbs (170a), numerals (170b), as discussed in §3.2.5, existential claims (170c), as discussed in §3.4.4, habitual actions (170d), and purpose clauses (170e), as discussed in §3.4.6.

- (170) a. De hine **e** loolooa.
 DET woman IPFV tall
 'The woman is tall.' (JR-20230414)
- b. Neyla kona i de lodo i denga gaagoo **e** dolu nei.
 Neyla very PREP DET want PREP DET.PL chicken IPFV three PROX
 'Neyla really loves these three chickens.' (ML-20210730)
- c. **E** dahi vaga henua gee ne dau i dua luu Dahanga.
 IPFV one canoe island different PFV arrive PREP back DET.DU Dahanga
 'There was a foreign canoe that arrived behind the Dahangas.' (Otto, 11-4, line 2)

- d. Soni **e** hano gi de hale golea i denga dolu laangi alodahi.
 Johnny IPFV go.SG to DET house goods PREP DET.PL three day all
 ‘Johnny goes to the store every Wednesday.’ (JR-20190708)
- e. Dahi laangi, gai gilaa ne loo-mai [bolo **e** dada mee i Senugu].
 one day so 3DU PFV come.PL-DIR.PROX COMP IPFV pick thing PREP Senugu
 ‘One day, they came (in order) to pick food on Senugu.’ (Molia, 11-1, line 22)

Ne marks perfective aspect, which indicates that an action is viewed as a complete, undivided whole. Perfective *ne* is typically translated with a past tense interpretation; compared with *gu*, *ne* is often used for events that happened in the more distant past.

- (171) a. De gaaduu **ne** kadi tama laa.
 DET dog PFV bite DET.child DIST
 ‘The dog bit that child.’ (JR-20221201)
- b. Buasalai gu dae mai gi de henua hoou [a Gaeuli **ne** gidee laa]...
 Buasalai INC arrive DIR.PROX to DET island new GEN.A Gaeuli PFV see DIST
 ‘Buasalai arrived at the new island that Gaeuli had found...’ (Gininga, 10-1, line 69)

However, *ne* can also be used for future events that are completed prior to topic time (172), demonstrating that *ne* encodes aspect rather than tense.

- (172) [Context: Johnny eats his breakfast every morning at 9am. Dagger says he plans to visit Johnny at 10am tomorrow morning to eat breakfast with him. I respond:]
 Soni **ne** gai mee odiodi i taiao.
 Johnny PFV eat thing empty.RED PREP DET.morning
 ‘Johnny will have eaten already in the morning.’ (JR-20221201)

Nogo marks past imperfective aspect, and indicates that the event/state no longer holds (173a-b). *Nogo* cannot be used for present or future imperfective readings (173); these readings are accomplished with the imperfective aspect marker *e* instead.

- (173) a. De gauligi **nogo** gadagada.
 DET child PST.IPFV laugh
 ‘The child was laughing.’ (JR-20230106)
- b. De ngaduu ne hano laa, Soni **nogo** hano gi de hale golea.
 DET year PFV go.SG DIST Johnny PST.IPFV go.SG to DET house goods
 ‘Last year, Johnny used to go to the store (e.g., every Wednesday).’ (JR-20190708)
 ED: ‘Does this mean he doesn’t go to the store anymore?’ JR: ‘Most likely.’
- c. Au e/***nogo** iakiuu nei.
 1SG IPFV/PST.IPFV baseball PROX
 Intended: ‘I’m playing baseball.’ (JR-20230701)

Gu marks inchoative aspect, which indicates that an action has begun just prior to topic time. With eventive verbs, *gu* is usually translated with a recent past interpretation (174a). With stative

verbs, *gu* takes on a present interpretation or a change-of-state reading (i.e., ‘become’), because the state has just begun and continues to hold at topic time (174b).

- (174) a. Emily **gu** humai i absasa.
 Emily INC come PREP U.S.
 ‘Emily has just come from the U.S.’ (JR-20221215)
- b. Au **gu** magalili.
 1SG INC cold
 ‘I am cold.’ (lit. ‘I have become cold.’) (ML-HA-20150608)

The change-of-state semantics associated with *gu* is apparent in contexts where it is infelicitous: for instance, *gu* is infelicitous with verbs like *modo* ‘unripe’, which cannot be construed as new states (175a), or in contexts where a state has held in the past and continues to hold at topic time (175b).

- (175) a. # De huaa gulu naa **gu** modo.
 DET fruit breadfruit MED INC unripe
 Intended: ‘That breadfruit is unripe.’ (JR-20221215)
 JR: ‘I would not say *gu*, that’s like something that changed from here to here.’
- b. [Context: Mary has been hungry ever since she has come home from work at 3pm today. At five o’clock, she still has not had anything to eat.]
 # Meeli **gu** hiigai i taa de lima.
 Mary INC hungry PREP DET.hour DET five
 Intended: ‘Mary was hungry at five o’clock.’ (JR-20221215)
 JR: ‘It doesn’t really describe that Mary has been hungry since 3 o’clock. This means that at 5, she became hungry.’

Ga marks prospective aspect, which indicates that an action will begin just after topic time. As such, *ga* is often translated with a near future interpretation (176).

- (176) a. Au **ga** seese adu gi kinaa.
 1SG PRSP walk DIR.MED to there.MED
 ‘I will walk over there (soon).’ / ‘I’m about to walk over there.’ (JR-20230414)
- b. De gaaduu **ga** kadi tama laa.
 DET dog PRSP bite DET.child DIST
 ‘The dog is about to bite that child.’ (JR-20230418)

Since prospective *ga* indicates an action which follows topic time, it is often used for actions that occur in sequence; for this reason, *ga* is the most common aspect marker found in narratives. *Ga* is used for subsequent clauses of clause chaining constructions (§3.4.6.3), as shown in (177), as well as adjunct clauses (§3.4.6.1), shown in (178).

- (177) Emily ne doolohi de gauligi [**ga** savini gi lote hale].
 Emily PFV chase DET child PRSP run to inside.DET house
 ‘Emily chased the child and ran into the house.’ (JR-20230302)

- (178) [Ga dugu maalie naa huu goe de galauna], gai e baba danuaa.
 PRSP place slowly IRR when 2SG DET fishing.net so IPFV ready good
 ‘If you lay the net slowly, it will be prepared well. (JR-20230309)

Gi marks the subjunctive mood, which is typically used to express deontic modality (e.g., ‘must, should’) or certain kinds of embedded clauses, which largely correspond to non-finite ‘to’-clauses in English (see §3.4.5.2). Transitive *gi* clauses require the addition of the verbal suffix *-(C)ia* plus the postverbal particle *ina* (3.3.4), as seen in (179b).

- (179) a. Soni **gi** gage.
 Johnny SBJV climb
 ‘Johnny must climb.’ (JR-20190708)
 JR: ‘It’s a command to do something. It seems like I am best to do it.’
 b. A Ruth e lodo Soni **gi** huudia ina mai dahi mamu.
 PN Ruth IPFV want Johnny SBJV pull.in.CIA INA DIR.PROX DET fish
 ‘Ruth wants Johnny to pull in the fish.’ (JR-20190603)

Subjunctive *gi* cannot co-occur with aspect marking, as shown in (180).¹⁶

- (180) Au ne lodo (bolo) [Mina **gi** { *e / *ne / *nogo } seni anaahi].
 1SG PFV want c Mina SBJV NPST / PFV / PROG sleep yesterday
 ‘I wanted Mina to { sleep / be sleeping / have slept } yesterday.’ (JR-20210923)

Kana is best translated by English ‘lest’ or ‘otherwise’, which I characterize as a negative purposive; it is used to describe undesirable outcomes of present circumstances (181).

- (181) a. Koe **kana** doo iho.
 2SG lest fall down
 ‘(Be careful, or else) you’ll fall.’ (JR-RR-20190624)
 b. Aude hagalau-dia oo malo, **kana** ssui i de langi.
 IMP.NEG hang-CIA 2SG.GEN.O clothes lest be.wet PREP DET rain
 ‘Don’t hang your clothes, otherwise they’ll get wet in the rain.’ (JR-RR-20190624)

Goi marks the continuative aspect, which indicates that an event or state held at a previous time and continues to the present time (e.g., ‘still’). *Goi* is always accompanied by the post-verbal particle *huu* ‘when/while’, which also appears in many adjunct clauses (§3.4.6).

- (182) Gimaadeu **goi** hai hegau nei **huu**.
 1PL.EXCL CONT do work PROX while
 ‘We are still working.’ (JR-RR-20190624)

Finally, *tigi* is best translated as ‘not yet’, and can be characterized as a negative continuative (183a). When combined with the existential verb *ai* and the emphatic particle *donu*, *tigi* can also be used to express something like ‘never’ (183b).

¹⁶In Chapter 4, I analyze subjunctive *gi* as a low complementizer which selects for a non-finite form of Infl, following Middleton’s (2021) analysis of subjunctive marking in Tokelauan.

- (183) a. De moni **tigi** abulu.
 DET canoe not.yet sink
 ‘The canoe hasn’t sunk yet.’ (JR-RR-20190624)
- b. Au **tigi** ai donu s-agu gai de gulu.
 1SG not.yet exist EMPH COP.SG-1SG.GEN.A eat DET breadfruit
 ‘I never eat breadfruit.’ (lit. ‘My eating breadfruit doesn’t exist yet.’) (JR-RR-20190626)

To my knowledge, *goi* ‘CONT, still’ and *tigi* ‘not yet’ are the only two aspect markers which can co-occur (184a), though this combination is sometimes judged to be ungrammatical (184b). No other aspect markers may co-occur.

- (184) a. Ia **goi tigi** gai mee ai huu.
 3SG CONT not.yet eat thing OBL when
 ‘She still hasn’t eaten.’ (JR-20230701)
- b. * Au **goi tigi** dae gi Nukuoro.
 1SG CONT not.yet reach to Nukuoro
 ‘I still haven’t reached Nukuoro.’ (JR-RR-20190624)

3.3.7.2 Tense

The aspect/mood particles described above (§3.3.7.1) generally do not encode tense; instead, temporal information is often encoded using the deictic particles *nei*, *naa*, and *laa* (§3.2.7). These particles are canonically used to encode spatial deixis, but may also be used for temporal deixis when they appear in the post-verbal position: the proximal deictic *nei* can be used for present tense, the medial deictic *naa* can be used for future tense/irrealis mood, and the distal deictic *laa* can be used for past tense.¹⁷ In this way, Nukuoro may be characterized as an optional tense language (e.g., Bochnak 2016).

The proximal deictic *nei* often combines with imperfective *e* to yield a present tense interpretation (185a). With inchoative *gu* and prospective *ga*, the addition of *nei* indicates that the action occurs immediately before or after the present time, respectively (185b-c).

- (185) a. Au e tilo **nei** gi dahi ada o dahi daane absasa.
 1SG IPFV look PROX to one picture GEN.O one man U.S.
 ‘I’m looking at a picture of an American man.’ (JR-20190705)
- b. Koe gu hano **nei** gi Nuguolo?
 2SG INC go.SG PRES to Nukuoro
 ‘Did you (just) go to Nukuoro?’ (JR-20190531)

¹⁷It is worth noting that these temporal deictic markers appear to be lower than aspect, which is surprising from a cartographic or functional hierarchy approach to clause structure (e.g., Cinque 1999; Ramchand & Svenonius 2014; Wiltschko 2014). On the analysis that I develop in Chapter 4, these tense particles would be located within the verb phrase; this unusual placement for tense markers warrants future research. Here, however, I note that deictic markers in the post-verbal position may be interpreted as spatial or temporal deictics, depending on context. This ambiguity may suggest that *nei*, *naa*, and *laa* are underspecified deictic modifiers/adjuncts, whose interpretation is conditioned by the presence of other functional structure, like T⁰.

- c. Au ga hano **nei** gi too Emily.
 1SG PRSP go PROX to DET.place Emily
 ‘I’m (just) about to go to Emily’s.’ (JR-20190603)

Proximal *nei* is also contained in the temporal indexicals *iai nei* ‘right now’ and *(an)ailaanei* ‘today’ (§3.3.6).

The medial deictic *naa* is often combined with the imperfective aspect marker *e* or inchoative *gu* to yield a future tense interpretation (186).

- (186) a. Au e tali bolo Mina e hudi **naa** dahi mamu.
 1SG IPFV hope COMP Mina IPFV pull.in IRR one fish
 ‘I hope that Mina catches a fish.’ (JR-20190603)
- b. Gu pala **naa** de langi?
 INC dissolve IRR DET rain
 ‘Will it rain?’ (JR-20150611)

I characterize *naa* as an irrealis marker, rather than a future tense marker, because it appears in past tense conditional contexts (187). However, *naa* cannot appear in other contexts that are typically characterized as irrealis, such as under negation (188).

- (187) Ne hagalau **naa** huu Soni anaahi, gai gidaadeu gu giidagi ailaanei.
 PFV catch.fish IRR when Johnny yesterday then 1PL.INCL INC eat.meat today.FUT
 ‘If Johnny caught fish yesterday, we will have meat to eat today.’ (JR-20230309)
- (188) # Emily tee hua daahili naa anaahi.
 Emily PFV.NEG sing song IRR yesterday
 Intended: ‘Emily didn’t sing yesterday.’ (JR-20230620)

Finally, the distal deictic *laa* can be used to indicate past tense (189), particularly when combined with the imperfective aspect marker *e*.

- (189) De masovaa a Mina e dunu ai **laa** mamu, gai ia e daadaa taagoli hogi.
 DET time GEN.A Mina IPFV cook OBL PST fish then 3SG IPFV peel DET.taro also
 ‘When Mina was cooking fish, she was peeling taro also.’ (JR-20190604)

Laa also appears frequently in questions (§3.5.1), which may be related to its function as a distal temporal deictic. This function of *laa* and its relationship to deixis warrants future research.

3.3.7.3 Negation

Sentential negation is expressed using the particle *dee*, which comes between the TAM marker and the verb (190). There is no nominal-level negation in Nukuoro (e.g., ‘no one’, ‘nothing’).

- (190) a. Ia e **dee** lodo ia gi mmule.
 3SG IPFV NEG want 3SG SBJV late
 ‘He doesn’t want to be late.’ (JR-RR-ML-20190627)

- b. Au gu **dee** manadua.
 1SG INC NEG remember
 ‘I don’t remember.’

(JR-RR-20190628)

In the perfective aspect, perfective *ne* plus the negative particle *dee* are expressed by a single morpheme *tee* (191).

- (191) Ia **tee** gai donu hanu gulu.
 3SG PFV.NEG eat EMPH some breadfruit
 ‘S/he didn’t eat any breadfruit.’

(JR-20190531)

There is also a negative phrase *dee ai*, which consists of the negative particle *dee* plus a non-productive existential verb *ai* (see §3.4.4). *Dee ai* is used in negative existentials (192) and as a negative response particle (193).

- (192) E **dee ai** gauligi suguulu ne mmagi anailaanei.
 IPFV NEG exist child school PFV sick.PL today.PST
 ‘There are no students who are sick today.’

(JR-RR-ML-20190627)

- (193) a. De gaaduu e noho i hongade laagau.
 DET dog IPFV sit PREP top DET log
 ‘The dog is sitting on the log.’

(JR-20190705)

- b. **Dee ai**, de gaaduu e noho i lote vai.
 no DET dog IPFV sit PREP inside.DET water
 ‘No, the dog is sitting in the water.’

(JR-20190705)

3.4 Clauses and clausal phenomena

This section describes the structure of basic clauses and other clause types and clausal phenomena. I begin by discussing basic Nukuoro word order flexibility and limited case marking (§3.4.1); I then turn to non-basic clause types, including non-verbal predication (§3.4.2), existentials (§3.4.4), complement clauses (§3.4.5), adjunct clauses (§3.4.6), and imperatives (§3.4.7). I close the section by discussing comparatives and superlatives (§3.4.3), conjunction and disjunction (§3.4.8), and modality (§3.4.9).

Nukuoro clauses have basic SVO(X) word order, where X represents oblique and adjunct arguments. Preverbal subjects are separated from the verb by aspect/mood particles and negation (§3.3.7); a number of post-verbal elements appear between the verb and the following object, including directionals (§3.3.5), manner adverbs (§3.3.6), incorporated objects (§3.3.1.6), the oblique resumptive pronoun *ai* (§3.3.2.3), the particle *ina* (§3.3.4), and temporal deictic markers (§3.3.7.2). A general schema for an SVO clause is provided in (194).

- (194) **Subject** - Aspect - (Neg) - **Verb** - (Particles) - **Object** - (Obliques)

Post-verbal subjects appear in a number of dependent clause types, such as adjunct clauses (§3.4.6) and nominalized clauses (§3.2.10). Post-verbal subjects obligatorily occur after the verb and its particles but before the object and any obliques, yielding VSOX order. VSO clause structure is schematized in (195).

(195) Aspect - (Neg) - **Verb** - (Particles) - **Subject** - **Object** - (Obliques)

3.4.1 Word order and case marking

Nukuoro word order is SVO-VSO alternating: while SVO is the dominant word order, verb-initial orders are also permitted in a limited set of contexts, including dependent clause types, such as nominalized and adjunct clauses, polar questions, and (sometimes) intransitive clauses.

SVO word order is the basic word order used in declarative matrix clauses, as shown in (196).

- (196) a. **De gaaduu** nei e goo.
 DET dog PROX IPFV bark
 ‘This dog is barking.’ (JR-20210818)
- b. **Koe** ne daudali ange gi taane laa.
 2SG PFV follow DIR.DIST to DET.man DIST
 ‘You followed that man.’ (ML-20210709)
- c. **Gimaadeu** ne gaamai hanu ngago.
 1PL.EXCL PFV bring some egg
 ‘We collected some eggs.’ (JR-20190704)

Speaker judgement varies on the acceptability of verb-initial word orders in intransitives. Some speakers allow intransitive clauses to use SV and VS orders (197), while other speakers reject VS orders in intransitives (198).

- (197) a. **Denga vai** gu kai.
 DET.PL water INC boil
 ‘The water boiled.’ (JR-RR-20190624)
- b. Gu kai **denga vai**.
 INC boil DET.PL water
 ‘The water boiled.’ (JR-RR-20190624)
- (198) a. **De gauligi laa** gu doo iho.
 DET child DIST INC fall down
 ‘The child fell down.’ (ML-20210709)
- b. * Gu doo iho **de gauligi laa**.
 INC fall down DET child DIST
 Intended: ‘The child fell down.’ (ML-20210709)

All speakers consulted reject VSO orders in declarative middle clauses (199a-200a) and transitive clauses (199b-200b).

- (199) a. *E vaasuu (ai) **denga gauligi** i de gaaduu.
 IPFV like OBL DET.PL child PREP DET dog
 Intended: 'The children love the dog.' (JR-RR-20190624)
- b. *Ne gai **de gauligi** de gahudi.
 PFV eat DET child DET banana
 Intended: 'The child ate the banana.' (JR-20220627)
- (200) a. *Ne daudali ange **goe** gi taane laa.
 PFV follow DIR.DIST 2SG to DET.man DIST
 Intended: 'You followed that man.' (ML-20210709)
- b. *Ne gai **denga gaagoo** denga gaadinga.
 PFV eat DET.PL chicken DET.PL coconuts
 Intended: 'The chickens ate the coconuts.' (ML-20210709)

VSO orders are permitted in several contexts in Nukuoro, including adjunct clauses (201a), relative clauses (201b), polar questions (201c), and nominalized clauses, which are obligatorily verb-initial (201d).

- (201) a. [Ne daudali ange **goe** gi taane laa], koe e gidee ia.
 PFV follow DIR.DIST 2SG to DET.man DIST 2SG IPFV see 3SG
 'If you follow that man, you'll find him.' (ML-20210709)
- b. de masoaa ne saabai ai **au** de gede
 DET time PFV carry OBL 1SG DET basket
 'the time I carried the basket' (ML-20210917)
- c. Ne gai **de gauligi** de gahudi anaahi?
 PFV eat DET child DET banana yesterday
 'Did the child eat the banana yesterday?' (JR-20220627)
- d. Gu lava i [de hai ange **a de hine laa** de hada].
 INC finish PREP DET fix GEN.A DET woman DIST DET car
 'The woman finished fixing the car.' (JR-20211118)

As the previous examples show, there is no case marking on core arguments in present-day Nukuoro; morphological case is limited to genitive (§3.2.1). Historically, however, Nukuoro marked transitive subjects with the ergative case marker *e*, a system which is preserved in related Polynesian languages such as Samoan (Mosel & Hovdhaugen 1992). While ergative case marking is no longer used by present-day speakers, ergative case marking with *e* is found in narratives recorded in the early 1960s (Carroll 1980), albeit with a limited distribution.

Ergative marking in the textual corpus is only found on post-verbal subjects, most of which are pronouns. Furthermore, the distribution of ergative marking can be divided into two main contexts. First, ergative *e* appears on post-verbal subjects of certain verbs of perception and knowledge, namely *gidee* 'see', *manadua* 'think/remember', *langona* 'hear', *iloo* 'know', and *maua* 'be able' (202). Cognate verbs in other Polynesian languages also select for ergative subjects (e.g., Seiter 1980:126).

- (202) a. Gi dee iloo ai **e gilaadeu** bolo dahi dangada gu ulu...
 SBJV NEG know OBL ERG 3PL COMP one person INC enter
 ‘So they won’t know that someone has entered...’ (Molia, 11-1, line 89)
- b. Gai Gaeuli gu gidee **e ia** tagodo nei i mua...
 so Gaeuli INC see ERG 3SG DET.state PROX PREP before
 ‘But Gaeuli had forseen this situation...’ (Gininga, 10-1, line 303)

Second, *e* appears on demoted agents of passives (203), a use which appears in other Polynesian Outliers (e.g., Sikaiana; Donner 2012) and Eastern Polynesian languages (e.g., Maori; Bauer 1997).

- (203) De-laa d-ono hai e hai-a ai **e de gau i Hidi**.
 DET-DIST DET-3SG.GEN.O way IPFV do.CIA OBL ERG DET people PREP Tahiti
 ‘That’s what was done to him by the people of Tahiti.’ (Gininga, 10-1, line 261)

I extend this category to include ergative-marked subjects of verbs that appear with *-(C)ia/ina* in adjunct clauses, which might be themselves passives (204).

- (204) Gai ga hagaili-**a ina** naa huu **e goe**, gai ia ga langa ssugi gi lunga.
 then PRSP slap-CIA INA IRR when ERG 2SG then 3SG PRSP lift DET.tail to above
 ‘And when (he) is struck by you, he will lift up its tail.’ (Molia, 11-1, line 49)

3.4.2 Non-verbal predicates

In addition to verbal predicates, Nukuoro allows many other categories to act as predicates, including adjectives, prepositional phrases, indefinite nominals, and definite nominals. There is no copula in Nukuoro; non-verbal predicates are simply preceded by aspect marking (see §3.3.7).

Adjectives may act as predicates without any verbalizing morphology or copula (205).

- (205) a. Koe e **mmule**, gai au ga hano ai loo.
 2SG IPFV late then 1SG PRSP go.SG OBL EMPH
 ‘You were late, so I left.’ (JR-20190605)
- b. Emily e **looloa**, gai a Noa e **bodobodo**.
 Emily IPFV tall then PN Noa IPFV short
 ‘Emily is tall, but Noa is short.’ (JR-20190607)

Similarly, prepositional phrases can be used as predicates as well (206). In the imperfective aspect, prepositional predicates appear without an aspect marker.

- (206) a. Dahi gaaduu **i lote hale**.
 one dog PREP inside.DET house
 ‘A dog is inside the house.’ (JR-RR-20190628)
- b. Noo **i de hale magi** huu Soni, gai au e madagu.
 if PREP DET house sick when Johnny then 1SG IPFV afraid
 ‘If Johnny is still in the hospital, I will be scared.’ (JR-20221013)

In fact, prepositional predicates cannot co-occur with the imperfective aspect marker *e* (207a); however, they can co-occur with other aspect markers and negation (207b). When prepositional predicates are negated, the imperfective aspect marker *e* must appear before the negative particle *dee* (207).

- (207) a. Ia (***e**) i suguulu.
 3SG IPFV PREP school
 ‘He is at school.’ (JR-RR-ML-20190627)
- b. Ia **nogo** i suguulu.
 3SG PST.IPFV PREP school
 ‘He was at school.’ (JR-RR-ML-20190627)
- c. De beebaa **e dee** i lote ngavesi.
 DET book IPFV NEG PREP inside.DET box
 ‘The book is not inside the box.’ (JR-20230504)

Noun phrases may also be used as predicates, though they must appear with an additional predicate-forming particle, such as the predicative focus marker *go* or the predicative indefinite particles *se* (singular) or *ni* (plural). *Go* can be used in identificational, equative, and specificational constructions, while *se/ni* are used in predicational constructions. These three elements all create predicates from nominal elements; for this reason, *go*, *se*, and *ni* may provisionally be characterized as copulas, where *go* is a dedicated focus copula that combines with DPs, and *se/ni* are copulas which combine with nouns/NPs.¹⁸

Identificational sentences, which relate a deictic element and a nominal, are formed using a demonstrative pronoun (§3.2.7) followed by a definite noun phrase. The nominal may appear on its own (208a) or be preceded by the focus copula *go* (208b).

- (208) a. De-laa de meiolu.
 DET-DIST DET mayor.
 ‘That’s the mayor.’ (JR-RR-ML-20190627)
- b. De-laa **go** de hale daumaha.
 DET-DIST COP.FOC DET house church
 ‘That’s the church.’ (JR-20230414)

Equative constructions, which relate two referential expressions, involve two nominals which are both marked by *go* (209). I assume that these are pseudocleft focus constructions (see §3.5.2), which are biclausal, explaining the presence of two copulas.

¹⁸A copular analysis runs counter to standard treatments of Polynesian languages, which are typically assumed to lack (overt) copulas (e.g., Maori, Bauer 1993; Samoan, Mosel & Hovdhaugen 1992). Instead, *go* is often treated as a preposition (e.g., Massam et al. 2006) or a focus marker (Hohaus & Howell 2015) and *se/ni* have been analyzed as indefinite determiners (e.g., Chung & Ladusaw 2004). Further research is needed to determine which of these analyses is most appropriate for Nukuoro; for concreteness, I gloss *go* as a focus marker and *se/ni* as a copula.

- (209) a. **Go** au **go** Soni.
 COP.FOC 1SG COP.FOC Johnny
 ‘I am Johnny.’ (Drummond et al. 2019:165)
- b. **Go** au naa **go** koe, au gu hano odiodi.
 COP.FOC 1SG IRR COP.FOC 2SG 1SG INC go.SG already
 ‘If I were you, I would have gone already.’ (JR-RR-20190624)

Specificational constructions, which specify who or what a particular individual is, typically involve one nominal that is marked by *go* (210). Either element may be preceded by *go* (and in either linear order), depending on which element is in focus: (210b) is specifying who the mayor is, while (210c) is specifying who Senard is.

- (210) a. Gilaadeu **go** denga gauligi suguulu.
 3PL COP.FOC DET.PL child school
 ‘They are the students.’ (JR-RR-ML-20190627)
- b. **Go** ia de meiolo.
 COP.FOC 3SG DET mayor
 ‘He’s the mayor.’ (JR-RR-ML-20190627)
- c. Seenala **go** de meiolo o Nukuoro.
 Senard COP.FOC DET mayor GEN.O Nukuoro
 ‘Senard is the mayor of Nukuoro.’ (JR-RR-ML-20190627)

It is also possible for both nominals in a specificational construction to be marked by *go* (211).

- (211) **Go** ia **go** de meiolo o Nukuoro.
 COP.FOC 3SG COP.FOC DET mayor GEN.O Nukuoro
 ‘He is the mayor of Nukuoro.’ (JR-RR-ML-20190627)

Nominals marked by *go* cannot occur with the imperfective aspect marker *e* (212a); however, other aspect markers and negation may co-occur with nominal predicates marked by *go* (212b).

- (212) a. *De-laa **e go** de hale daumaha.
 DET-DIST IPFV COP.FOC DET house church
 Intended: ‘That’s the church.’ (JR-20230906)
- b. Au **gu dee** go Vave.
 1SG INC NEG COP.FOC Vave
 ‘I am no longer Vave.’ (Leaba, 11-8, line 117)

Predicational copular constructions, which predicate a nominal property of a subject, use the particles *se* and *ni*, which create predicates from bare nominals. *Se* is used for singular subjects and *ni* is used for plural subjects (213).

- (213) a. Ia **se** dogidaa.
 3SG COP.SG doctor
 ‘He is a doctor.’ (JR-20190627)

- b. Gilaadeu **ni** gauligi suguulu.
 3PL COP.PL child school
 ‘They are students.’ (JR-20190627)

Like prepositional predicates, nominal predicates with *se/ni* cannot appear with the imperfective aspect marker *e* (214a), but they can occur with all other aspect markers (214b). Negated *se/ni* predicates require imperfective *e* to occur before the negative particle *dee* (214c).

- (214) a. Ia (***e**) se gauligi suguulu.
 3SG IPFV COP.SG child school
 ‘S/he is a student.’ (JR-RR-ML-20190627)
- b. Ia **nogo** se gauligi suguulu.
 3SG PST.IPFV COP.SG child school
 ‘He was a student.’ (JR-RR-ML-20190627)
- c. Ia **e dee** se gauligi suguulu.
 3SG IPFV NEG COP.SG child school
 ‘He is not a student.’ (JR-RR-ML-20190627)

Se and *ni* may only create predicates from bare nominals: they cannot co-occur with indefinite determiners, such as *dahi* or *hanu* (215), or definite determiners, like *de(nga)* (216).

- (215) a. *Ia **se dahi** gauligi suguulu.
 3SG COP.SG one child school
 Intended: ‘He is a/one student.’ (JR-20190627)
- b. *Gilaadeu **ni hanu** gauligi suguulu.
 3PL COP.PL some child school
 Intended: ‘They are (some) students.’ (JR-20190627)
- (216) a. *Ia **se de** gauligi suguulu.
 3SG COP.SG DET child school
 Intended: ‘He is a/the student.’ (JR-20190627)
- b. *Gilaadeu **ni denga** gauligi suguulu.
 3PL COP.PL DET.PL child school
 Intended: ‘They are (the) students.’ (JR-20190627)

The copulas *se/ni* can be used not only for indefinite nominals, but also for nominalized clauses (217): clauses introduced by predicative *se* typically introduce a reason for one’s actions.

- (217) a. Hidinga o luu daagami o d-ono damana ne loo-adu ai
 reason GEN.O two soldier GEN.O DET-3SG.GEN.O father PFV come.PL-DIR.MED OBL
 laa, **se loo-adu** e daalo a Logo.
 DIST COP.SG come.PL-DIR.MED IPFV stab PN Logo
 ‘The reason his father’s guards came was to come stab Logo.’ (Gininga, 10-1, line 151)

- b. **Se loo-mai** naa gooluu e aha?
 COP.SG come.PL-DIR.PROX IRR 2DU IPFV what
 ‘What have you come for?’ (Gininga, 10-1, line 153)

Se and *ni* are also used in indefinite focus and question contexts (§3.5.2), which require the focused/questioned element to be the predicate of a pseudocleft (see Chapter 5). *Se* is used for singular focused indefinites, including singular question words (218a), and *ni* is used for plural focused indefinites, including plural question words (218b). For more on questions and focus, see §3.5.1.2 and §3.5.2.

- (218) a. **Se goede** aana e lodo laa Soni gi huudia age.
 COP.SG octopus 3SG.GEN.A IPFV want DIST Johnny SBJV pull.in.CIA up
 ‘AN OCTOPUS is what s/he wants Johnny to catch.’ (JR-20190531)
- b. **Ni gulu** aagu e lodo e gai.
 COP.PL breadfruit 1SG.GEN.A IPFV want IPFV eat
 ‘BREADFRUIT is what I want to eat.’ (JR-20190704)

Se is used in negative existential contexts (219), under the existential verb (*i*)*ai* (§3.4.4). Only *se* may appear in this environment: it is ungrammatical to use *ni* in negative existential contexts. For more on existential constructions, see §3.4.4.

- (219) Tee ai { **se** / *ni } dangada ne magau.
 PFV.NEG exist COP.SG COP.PL person PFV die.SG
 ‘Nobody died.’ (JR-20200608)

Ni may be used to create possessive predicates (e.g., ‘be mine/yours/Mina’s’) as well; *ni* is used whether the subject is singular or plural. Possessive predicates with *ni* can be used in a matrix clause (220a) or as a nominal modifier (220b).

- (220) a. Tama laa **ni aagu**.
 DET.child PROX COP.PL 1SG.GEN.A
 ‘That child is mine.’ (JR-RR-ML-20190627)
- b. Tama-ahine laa se damaahine **ni Mina**.
 DET.child-female PROX COP.SG child-female COP.PL Mina
 ‘That girl is a daughter of Mina’s.’ (JR-RR-ML-20190627)

3.4.3 Comparatives and superlatives

Comparatives are formed using an adjective as a predicate, followed by the distal directional *ange* and a prepositional phrase containing the standard of comparison (221).

- (221) Emily e looloa **ange i a Soni**.
 Emily IPFV tall DIR.DIST PREP PN Johnny
 ‘Emily is taller than Johnny.’ (JR-20200629)

If the comparative involves a verbal construction, the standard of comparison is introduced using *ange* plus the preposition *i* at the end of the clause (222).

- (222) a. E soa dangada Nukuoro e nnoho i Pohnpei **ange i Nukuoro**.
 IPFV many people Nukuoro IPFV live.PL PREP Pohnpei DIR.DIST PREP Nukuoro
 ‘More Nukuoro people live on Pohnpei than on Nukuoro.’ (JR-20200715)
- b. Soni ne llanea ana mamu ne hudi anailaanei **ange i a Sigi anaahi**.
 Johnny PFV plenty 3SG.GEN.A fish PFV catch today.PST DIR.DIST PREP PN Sigi
 yesterday
 ‘Johnny caught more fish today than Sigi did yesterday.’ (JR-20200715)

Superlatives can be formed using the word *hugadoo*, which indicates maximality (e.g., ‘above all’). *Hugadoo* can appear after the nominal (223a) or after the adjectival predicate (223b).

- (223) a. Emily **hugadoo** e looloa i magoaa olaadeu d-ono huaabodu.
 Emily above.all IPFV tall PREP among 3PL.GEN.O DET-3SG.GEN.O family
 ‘Emily is the tallest among her family.’ (JR-20200629)
- b. Emily e looloa **hugadoo** i magoaa olaadeu d-ono huaabodu.
 Emily IPFV tall above.all PREP among 3PL.GEN.O DET-3SG.GEN.O family
 ‘Emily is the tallest among her family.’ (JR-20230427)

It is also possible to form a superlative by using an adjectival predicate plus *ange* with no prepositional standard of comparison (224).

- (224) Soni ma Daagele aama Sigi ne kage, gai Soni ne **mao lunga ange**
 Johnny and Dagger and Sigi PFV climb.PL then Johnny PFV high DIR.DIST
 d-ono momme ne dae ai.
 DET-3SG.GEN.O place PFV reach OBL
 ‘Johnny, Dagger, and Sigi climbed, but Johnny reached the highest place.’ (JR-20200629)

3.4.4 Existentials and ‘have’ constructions

Existential constructions are formed with an aspect marker, typically the imperfective aspect marker *e*, followed by a nominal (225). Nukuoro has no (overt) expletive subject or copula.

- (225) a. E hanu biigi i Nuguolo.
 IPFV some pig PREP Nukuoro
 ‘There are pigs on Nukuoro.’ (JR-20190703)
- b. Nogo hanu doa i Nukuoro.
 PST.IPFV some giant PREP Nukuoro
 ‘There used to be giants on Nukuoro.’ (JR-20230420)

- c. E dahi naa daonga i d-ogu boo.
 IPFV one IRR party PREP DET-1SG.GEN.O birthday
 ‘There will be a party on my birthday.’ (JR-20230420)

Negative existential contexts use an existential verb (*i*)*ai*, which is negated using the negative particle *dee* (226); (*i*)*ai* cannot appear in positive existential contexts.¹⁹

- (226) a. E dee **ai** donu gauligi suguulu ne mmagi anailaanei.
 IPFV NEG exist EMPH child school PFV sick.PL today.PST
 ‘There are no students who are sick today.’ (JR-20190627)
- b. Nogo dee **ai** donu biigi i Nukuoro.
 PST.IPFV NEG exist EMPH pig PREP Nukuoro
 ‘There didn’t used to be pigs on Nukuoro.’ (JR-20230420)

‘Have’ constructions can be formed in two ways in Nukuoro. The first uses the same existential verb (*i*)*ai*, which is used most frequently to express verbal possession in relative clauses (227).

- (227) a. Go d-ono bodu donu **iai** laa ana dama.
 COP.FOC DET-3SG.GEN.O spouse EMPH have DIST 3SG.GEN.A child
 ‘That’s his wife that had his children.’ (Gininga, 10-1, line 87)
- b. Gu baa mai tangada **iai** de galauna.
 INC be.close DIR.PROX DET.person have DET fishing.net
 ‘The person who has the fishing net will come closer.’ (Molia, 11-1, line 62)

Typically, however, ‘have’ constructions are formed using an existential construction (228a), a common strategy for forming ‘have’-constructions cross-linguistically (e.g., Freeze 1992). These existential ‘have’ constructions can also have an overt pre-verbal subject, which doubles the possessive pronoun (228b).

- (228) a. E dogo lua **ana** dama.
 IPFV CL.HUM two 3SG.GEN.A child
 ‘She has two children.’ (JR-20210826)
- b. { **Ia** / **Mina** } e dogo lua **ana** dama.
 3SG Mina IPFV CL.HUM two 3SG.GEN.A child
 ‘She/Mina has two children.’ (JR-20210826)

The construction in (228b) is reminiscent of external possession or ‘possessor raising’ (e.g., Payne & Barshi 1999), where a possessor unexpectedly occurs as an argument of a verb. The Nukuoro construction differs from canonical external possession, however, in that the argument

¹⁹The existential verb (*i*)*ai* is found in various Polynesian languages and is thought to have originated as a prepositional phrase (preposition *i* + anaphoric *ai*), though it now conveys a purely lexical existential meaning (Moyses-Faurie 2010, 2019). Existential (*i*)*ai* is only found in two contexts in Nukuoro: in negative existential constructions and as the verb ‘to have’ in relative clauses.

and the possessor are both realized overtly; one could refer to this as ‘possessor copy raising’, since a copy of the possessor remains overt. Homer (2009) describes a similar pattern in Samoan; however, where Homer argues that Samoan displays backward control (e.g., Polinsky & Potsdam 2002), Nukuoro realizes both copies of the noun overtly.

It is tempting to analyze the pre-verbal nominal in these constructions as a hanging topic (see §3.5.3), which is co-referent with the pronoun in possessor position. If this were the case, the sentences in (228a) and (228b) would both lack a pre-verbal subject, but (228b) would contain a topic (*ia* or *Mina*) base-generated at the left edge of the clause. However, note that hanging topics in these constructions can undergo resumption in pre-verbal position, indicating that the pre-verbal argument is not itself a hanging topic. For example, in (229b), both the contrastive topic *Mina* as well as the resumptive pronoun *ia* appear pre-verbally, demonstrating that these two positions are distinct.

- (229) a. E dogo hia dama a dahi ma dahi oodou?
 IPFV CL.HUM how.many child GEN.A one and one 2PL
 ‘How many children do each of you have?’ (JR-20210826)
- b. Mina, **ia** e dogo lua **ana** dama...
 Mina 3SG IPFV CL.HUM two 3SG.GEN.A child
 ‘(As for) Mina, she has two children..’ (JR-20210826)

3.4.5 Complement clauses

There are three main complementation strategies in Nukuoro: the first of these strategies is finite, in the sense that it can show a full range of aspect distinctions, while the other two strategies are invariant for aspect and thus can be considered nonfinite. Verbs that take clausal complements may use just one of these embedding strategies, or they may utilize multiple strategies.

Finite complement clauses are introduced by the complementizer *bolo* or *be* and can take the full range of aspect/mood distinctions (230a). The first non-finite complementation strategy uses the particle subjunctive *gi*, cannot contain aspect marking, and optionally uses the complementizer *bolo* (230b); the second non-finite complementation strategy uses a nominalized clause, which is introduced by the determiner *de* and cannot include aspect marking (230). I discuss each of these three embedding strategies in more detail below.

- (230) a. Au e tali [**bolo** Mina e hudi naa dahi mamu].
 1SG IPFV hope COMP Mina IPFV pull.in IRR one fish
 ‘I hope that Mina catches a fish.’ (JR-20190603)
- b. Au ne dugu adu [(**bolo**) koe **gi** seese].
 1SG PFV allow DIR.MED COMP 2SG SBJV walk
 ‘I allowed you to walk.’ (JR-20190703)
- c. Au e dee lodo i [**de** hudi mai dahi mamu].
 1SG IPFV NEG want PREP DET pull.in DIR.PROX one fish
 ‘I don’t want to catch a fish.’ (JR-RR-20190701)

In addition to using the embedding strateg(ies) above, some embedding verbs also allow subordinate clauses to be expressed using a clause chaining construction (231). I discuss these kinds of constructions, and clause chaining more broadly, in §3.4.6.3.

- (231) a. Au ne bale ange Mina [ga hudi mai ai denga mamu].
 1SG PFV help DIR.DIST Mina PRSP pull.in DIR.PROX OBL DET.PL fish
 ‘I helped Mina and pulled in the fish.’ (JR-20190603)
- b. A Ruth e lodo [e hudi mai dahi mamu].
 PN Ruth IPFV want IPFV pull.in DIR one fish
 ‘Ruth wants to catch a fish.’ (JR-20190603)

3.4.5.1 Finite complement clauses

Finite complement clauses appear under predicates like *hai* (*ange*) ‘say’, *maanadu* ‘think’, *hagasaale* ‘think, decide’, *hagatau* ‘plan’, *hagadonusia* ‘believe’, *iloo* ‘know’, *hagatoo donu* ‘promise’, *tali* ‘hope’, *ssili* ‘ask’, *dagodo* ‘seem’, and *dulagi* ‘appear’. Finite declarative complements are introduced by a complementizer *bolo*, allow the full range of aspect marking, and must have an unmarked pre-verbal subject (232).

- (232) a. Ia e maanadu [bolo Mina ne buuludi ange Johnny].
 3SG IPFV think COMP Mina PFV hug DIR.DIST Johnny
 ‘He thinks that Mina hugged Johnny.’ (JR-20190604)
- b. Ruth e hai [bolo ia e ahe gi Nukuoro].
 Ruth IPFV say COMP 3SG IPFV return to Nukuoro
 ‘Ruth says she will return to Nukuoro.’ (JR-20190604)
- c. Au e hagatoo donu [bolo au e haangai denga gaagoo].
 1SG IPFV promise EMPH COMP 1SG NPST feed DET.PL chicken
 ‘I promise that I will feed the chickens.’ (JR-20190603)

Finite interrogative complements (i.e., embedded questions) are introduced by the interrogative complementizer *be* ‘if, whether’, which can be used to embed polar (233a) or content questions (233). Embedded polar and content questions show all the same syntactic behavior as their matrix counterparts, as described in §3.5.1.

- (233) a. Au ne ssili ange gi a Ruth [be Soni ne hudi dahi mamu].
 1SG PFV ask DIR.DIST to PN Ruth COMP.INT Johnny PFV pull.in one fish
 ‘I asked Ruth whether Johnny caught a fish.’ (JR-20200617)
- b. Au e iloo [be ni aha aau e hagasaale].
 1SG IPFV know COMP.INT COP.PL what 2SG.GEN.A IPFV think
 ‘I know what you’re thinking.’ (JR-20190621)

Complements of the predicates *dagodo* ‘seem’ and *dulagi* ‘appear’ are also introduced by the complementizer *be* (234).

- (234) a. E dagodo [**be** Soni e haga-duu dahi hale].
 IPFV seem COMP.INT Johnny IPFV CAUS-stand one house
 ‘It seems like Johnny is building a house.’ (JR-20200617)
- b. E dulagi [**be** Soni gu hudi dahi mamu].
 IPFV appear COMP.INT Johnny INC pull.in one fish
 ‘It seems like Johnny caught a fish.’ (JR-20200617)

In biclausal constructions with *dagodo* ‘seem’ and *dulagi* ‘appear’, the embedded subject may appear within the finite complement clause, as in (234), or in subject position of the higher clause (235). This alternation is reminiscent of a raising construction (Rosenbaum 1967; Postal 1974).²⁰

- (235) a. E dulagi [be **Soni** e hudi dahi mamu].
 IPFV appear COMP.INT Johnny IPFV pull.in one fish
 ‘It appears that Johnny is catching a fish.’ (JR-20200617)
- b. **Soni** e dulagi [be e hudi dahi mamu].
 Johnny IPFV appear COMP.INT IPFV pull.in one fish
 ‘Johnny appears to be catching a fish.’ (JR-20200617)

3.4.5.2 Subjunctive complement clauses

Subjunctive complements use the subjunctive particle *gi* in place of canonical aspect marking, and they may optionally be preceded by the complementizer *bolo* (236). Verbs that allow subjunctive complements include *lodo* ‘want’, *maua* ‘be able’, *dugu* ‘assign’, *dugu ange* ‘allow’, *hili* ‘choose’, and *hagatale* ‘try’.

- (236) a. Koe e maua [**gi** anu].
 2SG IPFV be.able SBJV dance
 ‘You can dance.’ (JR-RR-20190627)
- b. Ia ne dugu ange [(**bolo**) Mmea **gi** dunu ina denga mamu].
 3SG PFV allow DIR.DIST COMP Mmea SBJV cook INA DET.PL fish
 ‘She allowed Mmea to cook the fish.’ (JR-20200715)

Subjunctive embedded clauses are large enough to contain both negation and unmarked preverbal subjects (237a). However, subjunctive *gi* cannot co-occur with aspect marking (237b).

- (237) a. Ia ne hagatale ange (bolo) **ia** gi **dee** huudia dahi mamu.
 3SG PFV try DIR.DIST COMP 3SG SBJV NEG pull.in.CIA one fish
 ‘He tried not to catch a fish.’ (JR-20200617)

²⁰While the examples in (235) look like raising on the surface, it is not immediately clear whether this construction involves A- or \bar{A} -movement; I suggest in Chapter 5 that it is A-movement, but this claim warrants future research. If this is an instance of raising, it would be more precisely described as *hyperraising* (e.g., Ura 1994; Halpert 2019), as it involves movement out of a finite clause.

- b. Au ne lodo Mina **gi** (*e / *ne / *nogo) seni anaahi.
 1SG PFV want Mina SBJV IPFV PFV IPFV sleep yesterday
 ‘I wanted Mina to { sleep / have slept / be sleeping } yesterday.’ (JR-20210923)

Transitive subjunctive clauses require the embedded verb to appear with the verbal *-(C)ia* suffix and/or the post-verbal particle *ina* (238). The distribution of *-(C)ia/ina* is discussed in more detail in §3.3.4, and I provide an analysis of *-(C)ia/ina* in transitive subjunctive clauses in Chapters 6 and 7.

- (238) Ia ne hili Mina gi **diiloo** **ina** ange denga dama.
 3SG PFV choose Mina SBJV look.after.CIA INA DIR.DIST DET.PL children
 ‘She chose Mina to look after the children.’ (JR-20200715)

3.4.5.3 Nominalized complement clauses

Nominalized clauses are used to embed clauses under predicates which have been described as restructuring predicates (e.g., Wurmbrand 2001), including *hagatale* ‘try’, *maua* ‘be able’, *daa-mada* ‘begin’, *lava* ‘finish’, *duudagi* ‘continue’, *kii* ‘win (at)’, *ngalo* ‘forget’, *hai ngaohie* ‘be easy’, and *haingadaa* ‘be difficult’. Nominalized clauses are obligatorily verb-initial, lack aspect marking, and are introduced by the determiner *de* (239). Under restructuring predicates, nominalized complement clauses are introduced by the preposition *i*.

- (239) a. Ruth e hagatale ange i [de hudi mai dahi mamu].
 Ruth IPFV try DIR.DIST PREP DET pull.in DIR.PROX one fish
 ‘Ruth is trying to catch a fish.’ (JR-20190603)
- b. Au e maua i [de gidee heduu lagolago].
 1SG IPFV be.able PREP DET see stars many
 ‘I can see many stars.’ (JR-20190603)

Nominalized clauses can also be used under sensory predicates like *gidee* ‘see’ or *langona* ‘hear’ (240). With these predicates, nominalized clauses are not preceded by the preposition *i*, suggesting that they are syntactic arguments of the matrix verb.

- (240) a. Au ne gidee [de gage o Soni i de nui].
 1SG PFV see DET climb GEN.O Johnny PREP DET coconut.tree
 ‘I saw Johnny climb the tree.’ (JR-20200617)
- b. Au ne langona [de baguu o de manusomo].
 1SG PFV hear DET tip.over GEN.O DET tree
 ‘I heard the tree fall.’ (JR-20190607)

Nominalized clauses are structurally large enough to contain negation (241a), but do not allow aspect marking (241b) or unmarked pre-verbal subjects (241c).

- (241) a. Au ne hagatale i [**tee** basa].
 1SG PFV try PREP DET.NEG speak
 ‘I tried not to speak.’ (JR-RR-20190701)

- b. Ia ne maanadu age i [de (*e / *ne / *ga) anu].
 3SG PFV think up PREP DET IPFV PFV PRSP dance
 ‘S/he decided to dance.’ (JR-20230427)
- c. *E duudagi i [de **Ruth** llanga denga gede].
 IPFV continue PREP DET Ruth weave DET.PL basket
 Intended: ‘Ruth continues to weave the baskets.’ (JR-20230427)

Subjects of nominalized clauses must be post-verbal and marked with genitive case (242a).²¹ Pronominal subjects can also undergo genitive preposing (§3.2.8), where the genitive pronoun appears adjacent to or fused with the preceding determiner (242b).

- (242) a. Au ne gidee [de gai a **de moso** de unga].
 1SG PFV see DET eat GEN.A DET starling DET hermit.crab
 ‘I saw the starling eat the hermit crab.’ (JR-20200617)
- b. Ne hai ngaohie i [d-**ana** hai ange de hada].
 PFV do easy PREP DET-3SG.GEN.A fix DET car
 ‘It was easy for him/her to fix the car.’ (JR-20211118)

Predicates that take nominalized embedded clauses allow both arguments to appear within the embedded clause (244), but they also allow an argument to appear in argument position of the matrix predicate.²² Intransitive matrix predicates allow an embedded argument to appear in matrix subject position (243a); transitive matrix predicates allow an embedded argument to appear in matrix object position (243b).

- (243) a. **Au** e duudagi i [de dugidugi Soni].
 1SG IPFV continue PREP DET hit.RED Johnny
 ‘I continued to hit Johnny.’ (JR-20200617)
- b. Au ne langona **de manusomo** i [de baguu].
 1SG PFV hear DET tree PREP DET fall
 ‘I heard the tree fall.’ (JR-20190607)

Either argument of a transitive nominalized embedded clause may surface in the matrix clause: embedded subjects may appear in the matrix clause (244b) and objects may do the same, notably without requiring passive morphology on the embedded verb (244c).²³

²¹This creates a nominative-like pattern in nominalizations, since genitive marking appears on all subjects. I develop an analysis of Case assignment in nominalizations in Chapter 7.

²²Similar alternations in other Polynesian languages have been assumed or argued to involve raising (Seiter 1980; Longenbaugh & Polinsky 2018). However, there are reasons to doubt that the Nukuoro construction involves A-movement, if it involves movement at all. First, embedded objects can appear outside of the embedded clause (244c), violating classic assumptions about the locality profile of A-movement (though see Longenbaugh & Polinsky 2018). Second, the embedded arguments escape a nominalization, which is generally regarded to be impossible for A-movement. More likely, the alternations described here involve \bar{A} -movement, akin to so-called *tough*-movement in English (Chomsky 1977b), or prolepsis, which involves no cross-clausal movement at all (Salzmann 2017a,b).

²³It is not possible to for multiple arguments of an embedded clause to surface in the matrix clause at the same time.

- (244) a. Gu lava i [de hai ange a **de hine laa** de hada].
 INC finish PREP DET fix GEN.A DET woman DIST DET car
 ‘The woman finished fixing the car.’ (JR-20211118)
- b. **De hine laa** gu lava i [de hai ange de hada].
 DET woman DIST INC finish PREP DET fix DET car
 ‘The woman finished fixing the car.’ (JR-20211118)
- c. De hada gu lava i [de hai ange a **de hine laa**].
 DET car INC finish PREP DET fix GEN.A DET woman DIST
 ‘The car finished being fixed by the woman.’ (JR-20211118)

This kind of cross-clausal dependency is only restricted if the matrix predicate places animacy restrictions on its subject: inanimate arguments cannot appear in subject position of volitional predicates like *hagatale* ‘try’, for instance (245).

- (245) a. **De hine laa** ne hagatale ange i [de hai ange de hada].
 DET woman DIST PFV try DIR.DIST PREP DET fix DET car
 ‘The woman tried to fix the car.’ (JR-20211118)
- b. *De hada ne hagatale (ina) ange i [de hai ange a **de hine laa**].
 DET car PFV try INA DIR.DIST PREP DET fix GEN.A DET woman DIST
 Intended: ‘The car tried to be fixed.’ / ‘It was tried to fix the car.’ (JR-20211118)

3.4.6 Adjunct clauses

3.4.6.1 Verbal adjunct clauses

Adjunct ‘when’-clauses are typically predicate-initial and begin with the prospective aspect marker *ga*. Adjunct clauses of this type use the post-verbal particle *huu*, which is used to indicate simultaneity with the following matrix clause (246); future-oriented adjunct clauses also involve the irrealis particle *naa* (§3.3.7.2), which is used to indicate conditional or future action (246b).

- (246) a. [**Ga** tae mai **huu** gilaadeu], gai gilaadeu ga hai alaadeu huahuaamee.
 PRSP reach.PL DIR.PROX when 3PL so 3PL PRSP do 3PL.GEN.A magic
 ‘When they arrived, they did their magic.’ (Drummond et al. 2019: 150)
- b. [**Ga** haga-doo **naa huu** au ga hano gi lote daholaa], agai goodou ga
 PRSP CAUS-drop IRR when 1SG PRSP go to inside.DET whale so 2PL PRSP
 hua mai dogu hagamadubudubu.
 sing DIR.PROX DET-1SG.GEN.O praise
 ‘When I drop into the whale’s mouth, you will sing my praises.’ (Haini, 13-7, line 103)

Conditional adjunct clauses are often identical to ‘when’-clauses, introduced by the aspect marker *ga* and containing irrealis *naa* (247a). Alternatively, conditional clauses may be SVO clauses introduced by the complementizer *noo* ‘if’ (247b).

- (247) a. [Ga dugu maalie **naa** (**huu**) goe de galauna], gai e baba danuaa naa.
 PRSP put slowly IRR when 2SG DET fishing.net then IPFV ready good IRR
 ‘If you place the net slowly, it will be prepared well.’ (JR-20221013)
- b. [**Noo** koe e dugu maalie de galauna], gai e baba danuaa naa.
 if 2SG IPFV put slowly DET fishing.net then IPFV ready good IRR
 ‘If you place the net slowly, it will be prepared well.’ (JR-20221013)

Purpose clauses are verb-initial, introduced by the aspect marker *e* or the subjunctive particle *gi*, and require the post-verbal oblique anaphor *ai* (248).

- (248) a. Soni ne dau dahi beebaa [**e** ago **ai** ia de hai e doo ai taagoli].
 Johnny PFV read one book IPFV learn OBL 3SG DET way IPFV plant OBL DET.taro
 ‘Johnny read a book to learn how to grow taro.’ (JR-20200706)
- b. Au e hai ogu galaasa [**gi** maua **ai** au i de tilo gi danuaa].
 1SG IPFV do 1SG.GEN.O glasses SBJV be.able OBL 1SG PREP DET see SBJV good
 ‘I wear my glasses so that I can see better.’ (JR-20200706)

‘Because’ clauses are introduced by the conjunction *hiidinga* ‘because’ (249).

- (249) Ruth e dee hagadonusia au [**hiidinga** au gu hadumuna ange (gi de ia)].
 Ruth IPFV NEG believe 1SG because 1SG INC lie DIR.DIST to DET 3SG
 ‘Ruth doesn’t trust me because I lied to her.’ (JR-20200706)

3.4.6.2 Nominal adjunct clauses

Nominal adjunct clauses are introduced by a head noun like *masovaa* ‘time’, which is then modified by a relative clause. If the nominal adjunct clause precedes the matrix clause, it simply functions as a topicalized nominal (250a); if it follows the matrix clause, it must be introduced by the general preposition *i* (250b).

- (250) a. [**De masovaa** a Mina e dunu ai laa mamu], gai ia e daadaa
 DET time GEN.A Mina IPFV cook OBL DIST fish then 3SG IPFV peel.RED
 taagoli hogi.
 DET.taro also
 ‘While Mina was cooking fish, she was also peeling taro.’ (JR-20190604)
- b. Mina e dunu mamu i [**de masovaa** donu aana e daadaa ai taagoli].
 Mina IPFV cook fish PREP DET time EMPH 3SG.GEN.A IPFV peel.RED OBL DET.taro
 ‘Mina is cooking fish while she peels the taro.’ (JR-20190604)

Adjunct clauses may also be introduced in a prepositional phrase; these adjunct clauses begin with the preposition *i* and a locational noun, like *dua* ‘back’, *muli* ‘behind’, or *mua* ‘front’ (§3.3.2.2), to indicate the temporal relationship with the matrix clause. The locational noun is then followed by a nominalized clause (§3.2.10), which is predicate-initial and introduced by the determiner *de* (251).

- (251) [I **dua** de daadaa Mina taagoli], gai ia ga kabe denga obe.
 PREP back DET peel.RED Mina DET.taro then 3SG PRSP gouge.out DET.PL eye
 ‘After Mina peeled the taro, she cut out the eyes.’ (JR-20190604)

3.4.6.3 Clause chaining

Sequential actions are often conveyed using clause chaining constructions, which follow a clause with one or more adjunct clauses that begin with an aspect marker, typically the prospective aspect marker *ga* (252).

- (252) Ia ne daadaa taagoli, [ga kabe denga obe], [ga hhui i denga vai].
 3SG PFV peel.RED DET.taro PRSP gouge.out DET.PL eye PRSP wash PREP DET.PL water
 ‘She peeled the taro, cut out the eyes, and washed it in water.’ (JR-20190604)

Clause chains typically share a subject; as such, subjects of chained adjunct clauses are typically null due to *pro*-drop (see §3.2.1). It is also possible to have an overt post-verbal subject of a chained adjunct clause (253). I analyze chained clauses in more detail in Chapter 4 (§4.3.1).

- (253) Gai de kailuu laa ga galo adu [gu gidee **ia** de gaaduu].
 so DET frog DIST PRSP look DIR.MED INC see 3SG DET dog
 ‘So the frog looked over and he saw the dog.’ (JR-20150624)

3.4.7 Imperatives

Imperatives are typically formed using a bare verb followed by any objects or modifiers (254). Imperatives cannot use aspect marking, and the implied 2nd person subject is usually null.

- (254) a. Seni i hongasimaini!
 sleep LOC top cement
 ‘Sleep on the floor!’ (JR-20190624)
- b. Anu matali au!
 dance with 1SG
 ‘Dance with me!’ (JR-20190624)
- c. Aloha ange i de gau i doo gaogao!
 love DIR.DIST PREP DET people PREP 2SG.GEN.O beside
 ‘Love your neighbors!’ (JR-20190624)

Transitive imperative verbs cannot appear bare; instead, they must appear with the suffix *-(C)ia* and/or the post-verbal particle *ina* (255). I provide an analysis of *-(C)ia/ina* in transitive imperatives in Chapters 6 and 7.

- (255) a. **Huudia (ina)** mai de mamu!
 pull.in.CIA INA DIR.PROX DET fish
 ‘Pull in the fish!’ (JR-20190603)

- b. **Mmiidia** age denga vai nui!
suck.up.CIA up DET.PL water coconut
'Suck up the coconut water!' (JR-20190624)
- c. **Gai ina** laisi nei!
eat INA rice PROX
'Eat this rice!' (JR-20190624)

Subjects of imperatives are typically implied, but overt 2nd person subjects are possible: they may appear in post-verbal position (256a) or before the imperative as a kind of vocative (256b).

- (256) a. Savini **goe** i kinei!
run 2SG PREP here
'Run over here!' (JR-20230427)
- b. **Gooluu**, hai ange muuhuu gi d-ooluu bodu...
2DU say DIR.DIST please to DET-2DU.GEN spouse
'You two, please tell your husband..' (Deiao, 12-3, line 113)

Verbs that typically inflect for plurality may also inflect for plurality in their imperative use, reflecting a singular or plural intended addressee (257).

- (257) a. Gadagada!
laugh.SG
'Laugh!' (directed to one person) (JR-20190624)
- b. Kada!
laugh.PL
'Laugh!' (directed to two or more people) (JR-20190624)

Polite requests are made by adding *muuhuu* 'please' after the verb phrase (258).

- (258) Seesee (ange) **muuhuu** gi kilaa!
walk DIR.DIST please to there.3
'Please walk over there!' (JR-20190624)

3.4.8 Conjunction and disjunction

3.4.8.1 Conjunction

The coordinator (*aa*)*ma* can be used to coordinate a wide range of syntactic constituents, including nouns (259a), adjectives (259b), prepositional phrases (259c), predicative indefinites (259d), and verbs with aspect marking (259e).

- (259) a. Au ne dunu [hanu daagoli] **aama** [hanu gulu].
1SG PFV cook some taro and some breadfruit
'I cooked some taro and some breadfruit.' (ML-20210820)

- b. Au ne gidee de hine [mahamaha] **ma** [looloa] laa.
 1SG PFV see DET woman beautiful and tall DIST
 ‘I saw the tall and beautiful woman.’ (JR-20230420)
- c. Denga suugelele [i hongga dogu beede] **ma** [i hongga simaini].
 DET.PL sand PREP top DET-1SG.GEN.O bed and PREP top floor
 ‘The sand is on my bed and on the floor.’ (JR-20190628)
- d. Emily [se gauligi suguulu] **ma** [se dangada agoago] hogi.
 Emily COP.SG child school and COP.SG person teach also
 ‘Emily is a student and a teacher also.’ (JR-20230420)
- e. Gai gilaadeu [gu malanga] **ma** [gu hulo].
 so 3PL INC set.sail and INC go.PL
 ‘So they set sail and left.’ (Haini, 13-7, line 75)

When aspectless verbs are coordinated with (*aa*)*ma*, the second verb must be nominalized with the determiner *de* (260).

- (260) Emily ne [hhui] **ma de** [haga-mmasa] denga gumedi.
 Emily PFV wash and DET CAUS-be.dry DET.PL dish
 ‘Emily washed and dried the dishes.’ (JR-20230420)

When a pronoun is conjoined with a non-pronominal element, the pronoun must reflect the person and number of the entire coordination, not just the single pronominal conjunct. Cross-linguistically, these kinds of structures are referred to as ‘inclusory pronominals’ (e.g., Lichtenberk 2000) or ‘plural pronoun constructions’ (e.g., Vassilieva & Larson 2005). For example, when referring to the speaker and another person, it is ungrammatical to use the first person singular pronoun *au* (261a); instead, the conjoined pronoun must be first person dual *gimaau* (261b).

- (261) a. * **Au ma Mina** ne hulo gi de hale golea.
 1SG and Mina PFV go.PL to DET house goods
 Intended: ‘Mina and I went to the store.’ (JR-20230427)
- b. **Gimaau ma Mina** ne hulo gi de hale golea.
 1DU.EXCL and Mina PFV go.PL to DET house goods
 ‘Mina and I went to the store.’ (JR-20190628)

Full clauses cannot be conjoined by (*aa*)*ma* (262a); instead, clauses are conjoined by introducing the second clause with the complementizer *gai* ‘so, then’ (262b).

- (262) a. * Nui ne seese mai gi lodo **ma** dono dinana ga hano.
 Nui PFV walk DIR.PROX to inside so/then DET-1SG.GEN.O mother PRSP go.SG
 ‘Nui walked inside and her mother left.’ (JR-20211104)
- b. Nui ne seese mai gi lodo **gai** dono dinana ga hano.
 Nui PFV walk DIR.PROX to inside so/then DET-1SG.GEN.O mother PRSP go.SG
 ‘Nui walked inside and her mother left.’ (JR-20211104)

Adversative conjunctions are also accomplished using the complementizer *gai* ‘but’ (263).

- (263) a. De beebaa i tua de galaasa **gai** i mua de computer.
 DET book PREP DET.back DET glass but PREP before DET computer
 ‘The book is behind the glass but in front of the computer.’ (JR-RR-20190628)
- b. Au ne hagatale ange i de hudi dahi mamu, **gai** tee maua.
 1SG PFV try DIR.DIST PREP DET pull.in one fish but PFV.NEG be.able
 ‘I tried to catch a fish, but (I) couldn’t.’ (JR-20190531)

3.4.8.2 Disjunction

The disjunctive particle *(aa)be* ‘or’ may also be used to coordinate phrases. While the element that precedes *(aa)be* can be any kind of syntactic constituent, including nouns (264a-b), prepositional phrases (264c), or predicates (264d-e), the constituent that follows *(aa)be* must be a predicate. When coordinating nominals, for instance, the second disjunct must be preceded either by the focus marker *go*, which creates predicates from definite nominals, or *se/ni*, which creates predicative indefinites (see §3.4.2).

- (264) a. Mina ne poo age [dahi bule] **be** [se laagau].
 Mina PFV grab up one shell or COP.SG stick
 ‘Mina picked up a shell or a stick.’ (JR-20230420)
- b. Au ne hili [de biini buluu] **be** [go de biini nuui], au gu ngalo.
 1SG PFV choose DET pen blue or COP.FOC DET pen green 1SG INC forget
 ‘I chose the blue pen or the green pen, I forget.’ (JR-20230420)
- c. Denga gulu [i lote ngavesi] **aabe** [go i lalo teebele].
 DET.PL breadfruit PREP inside.DET box or COP.FOC PREP under DET.table
 ‘The breadfruit is inside the box or under the table.’ (JR-20190628)
- d. Au ne hili de biini [buluu] **be** [nuui], au gu ngalo.
 1SG PFV choose DET pen blue or green 1SG INC forget.
 ‘I chose the blue or green pen, I forget.’ (JR-20230420)
- e. Mina [ne hhui denga gumedi] **aabe** [ne hagammasa], au gu ngalo.
 Mina PFV wash DET.PL dish or PFV CAUS-be.dry 1SG INC forget
 ‘Mina washed the dishes or dried (them), I forget.’ (JR-20230420)

Disjunction with *(aa)be* can take narrow or wide scope with respect to modals (265) as well as conditionals (265).

- (265) a. Ruth e lodo e heda e ange gi [de senedele] **aabe** [go de chief].
 Ruth IPFV want IPFV meet DIR.DIST to DET senator or COP.FOC DET chief
 ‘Ruth wants to meet with the senator or the chief.’ (JR-20200715)
- ✓ Context 1: Ruth needs to talk to a government official. To solve her problem, she can talk to anyone in the government.
- ✓ Context 2: Ruth told me that she needs to talk to a particular government official, but I can’t remember whether she was talking about the chief or the senator of Nukuoro.

- b. Ga humai naa huu [a Ruth] **aabe** [go Mina], gai ia e gaamai dalogo.
 PRSP come IRR when PN Ruth or COP.FOC Mina then 3SG IPFV bring toddy
 ‘If Ruth or Mina comes to the party, she will bring dalogo.’ (JR-20200715)
 ✓ Context 1: Ruth and Mina always bring dalogo to my parties, so I know if either person shows up, we will have dalogo.
 ✓ Context 2: Someone was telling me that they plan to bring dalogo to my party, but I can’t remember if it was Ruth or Mina.

3.4.9 Modality

There are very few lexicalized modals in Nukuoro: only possibility modals have dedicated lexical items, namely the embedding verb *maua* ‘be able’ as well as the verbal prefix *vaa-* ‘can’ (266).

- (266) a. Soni e **maua** i de hudi e ono mamu i dahi laangi sogosogo.
 Johnny IPFV be.able PREP DET pull.in IPFV six fish PREP one day alone
 ‘Johnny can catch six fish in one day.’ (JR-20190704)
- b. Gu dee **vaa-**hano a Daula.
 INC NEG can-go.SG PN Daula
 ‘Daula could not go any further.’ (Haini, 13-7, line 129)

All other modal categories recruit existing verbs or aspect markers to convey modal meanings. Table 3.17 summarizes possible combinations of modal flavor (e.g., epistemic, circumstantial, and deontic) and modal force (e.g., necessity or possibility), indicating the Nukuoro particles which are used in those contexts. Note that *maua* ‘be able’ can only be used for deontic and circumstantial possibility, and *vaa-* ‘be able’ is only used in a subset of circumstantial possibility contexts (indicated by the parentheses).

	Necessity	Possibility
Deontic	<i>hai gi, e</i>	<i>maua</i>
Circumstantial	<i>ga</i>	<i>maua, (vaa-)</i>
Epistemic	<i>e</i>	<i>mele, agu made</i>

Table 3.17: Modal categories and their expression

Deontic modality describes what is required or permitted given a set of laws, rules, or moral principles. If something is required by a law, rule, or principle (i.e., deontic necessity), it can be expressed in Nukuoro using the verb *hai* ‘do/make’ followed by a subjunctive clause (267).

- (267) Ga savini naa huu tangada i de baasigele, gai ia e **hai** **gi** goobai.
 PRSP run IRR when DET.person PREP DET bicycle so 3SG IPFV do/make SBJV hat
 ‘When one rides a bike, one must wear a helmet.’ (JR-20200623)
 JR: ‘The *hai* means you are required, it’s a must.’

Deontic necessity can also be expressed using a basic clause introduced by the imperfective aspect marker *e* (268).

(268) [Context: You're at the hospital to visit a friend. When you arrive, the receptionist at the desk says:]

a. Dangada e **hai gi** aahe i taa de ono.
 people IPFV make SBJV return.PL PREP DET.turn DET six
 'People must leave by 6 o'clock.' (JR-20230427)

b. Dangada e aahe i taa de ono.
 people IPFV return.PL PREP DET.turn DET six
 'People must leave by 6 o'clock.' (JR-20230427)

If something is merely possible or permitted according to a rule or principle (i.e., deontic possibility), it may be expressed using the verb *maua* 'be able' (269a).

(269) a. [Context: The lifeguard says that kids are allowed to go swimming, but Kriss doesn't know how to swim.]

Kriss e **maua** i de gaugau.
 Kriss IPFV be.able PREP DET swim
 'Kriss can swim.' (JR-20200623)

b. [Context: At Nett Point, there is a rule that only children 6 years and older can jump off of the pier. Nui is 8 years old, so she is old enough to jump if she wants to.]

Nui e **maua** i de lele gi lote lausedi.
 Nui IPFV be.able PREP DET jump to inside.DET water
 'Nui may jump in the water.' (JR-20230427)

Circumstantial modality describes what is possible or necessary due to a particular set of circumstances. If something must occur due to the current conditions (i.e., circumstantial necessity), it is expressed using the prospective aspect marker *ga* (270).

(270) a. Aude haihaia, au **ga** paa nei de mahidua.
 excuse.me 1SG PRSP explode PROX DET sneeze
 'Excuse me, I have to sneeze.' (JR-20200623)

b. [Context: Ruth is usually very serious, but she fell asleep in church with her mouth open, making a funny face.]

Gai au **ga** gadagada (ai).
 so 1SG PRSP laugh OBL
 'I had to laugh (at it).' (JR-20200623)

If something is possible given a particular set of conditions (i.e., circumstantial possibility), it can be expressed using the verb *maua* 'be able' (271).

- (271) a. [Context: Nukuoro Atoll is very remote, so there is no light pollution. It is sometimes cloudy, but often very clear.]
 Au e **maua** gi gidee heduu lagolago i Nukuoro.
 1SG IPFV be.able SBJV see star many PREP Nukuoro
 ‘I can see many stars on Nukuoro.’ (JR-20230427)
- b. [Context: Mina broke her foot in an accident three weeks ago, but she’s able to walk now. However, the doctor said she is not allowed to walk for another two weeks.]
 Mina e **maua** i de seesee.
 Mina IPFV be.able PREP DET walk
 ‘Mina can walk.’ (JR-20200623)

There is an additional modal prefix *vaa-* ‘can’, which can be used in cases of physical possibility, a subtype of circumstantial possibility. If something is possible given one’s physical strength or capability, *vaa-* may appear as a prefix on the verb (272a). It is impossible to use *vaa-* in other circumstantial possibility contexts which do not require physical capability (272b).

- (272) a. [Context: Mina broke her foot in an accident three weeks ago, but she’s able to walk now. However, the doctor said she is not allowed to walk for another two weeks.]
 Mina e **vaa**-seesee.
 Mina IPFV can-walk
 ‘Mina can walk.’ (JR-20230427)
- b. [Context: Nukuoro Atoll is very remote, so there is no light pollution. It is sometimes cloudy, but often very clear.]
 # Au e **vaa**-gidee heduu lagolago i Nukuoro.
 1SG IPFV can-see star many PREP Nukuoro
 Intended: ‘I can see many stars on Nukuoro.’ (JR-20230427)
 JR: ‘*vaa* applies when you have enough strength to do something, but seeing the stars does not require strength.’

Finally, epistemic modality describes what is possible or necessary due to one’s particular knowledge or evidence. If something must be true given the available evidence and knowledge about the world (i.e., epistemic necessity), it is expressed using a basic clause in the imperfective aspect (273a); note that prepositional predicates do not use an overt imperfective aspect marker (§3.4.2). It is not possible to use the verb *hai* ‘do/make’ in epistemic necessity contexts (273b).

- (273) [Context: I know that Johnny goes to Sigi’s house for coffee every afternoon. I stop by Johnny’s house in the afternoon and Johnny isn’t there, so I say:]
- a. Soni i de hale o Sigi iai nei.
 Johnny PREP DET house GEN.O Sigi now PROX
 ‘Johnny is at Sigi’s house.’ / ‘Johnny must be at Sigi’s house.’ (JR-20200623)
- b. # Soni e **hai** gi i de hale o Sigi iai nei.
 Johnny IPFV do/make to PREP DET house GEN.O Sigi now PROX
 ‘Johnny must be at Sigi’s house.’ (JR-20200623)
 JR: ‘No, doesn’t apply in this situation.’

If something is possible given the evidence and knowledge about the world (i.e., epistemic possibility), it can be expressed by using the word *mele* ‘maybe’ (274), the phrase *agu made* ‘maybe’ (275a), or a polar disjunction, similar to ‘may or may not’ (275b). It is not possible to use the verb *maua* ‘be able’ in cases of epistemic possibility (275c).

(274) [Context: Johnny lost his computer. He has checked in almost every room in the house and he still hasn’t found it, although he has yet to check the closet.]

Mele de computer a Soni gu tili.
 maybe DET computer GEN.A Johnny INC lose
 ‘Maybe Johnny’s computer is lost.’ (JR-20200623)

(275) [Context: Nui regularly skips school, so the teachers never know whether she will be there on a given day.]

a. **Agu made** Nui e humai naa gi suguulu ailaanei.
 1SG.GEN.A look.at Nui IPFV come IRR to school today.FUT
 ‘Maybe Nui will come to school today.’ (JR-20230427)

b. Nui e humai naa **aabe** e dee humai naa gi suguulu ailaanei.
 Nui IPFV come IRR or IPFV NEG come IRR to school today.FUT
 ‘Nui may or may not come to school today.’ (JR-20230427)

c. # Nui e **maua** i de humai gi suguulu ailaanei.
 Nui IPFV be.able PREP DET come SBJV school today.FUT
 Intended: ‘Nui might come to school today.’ (JR-20230427)

3.5 Questions, focus, and topic

3.5.1 Questions

3.5.1.1 Polar questions

Matrix polar questions are marked by clause-final rising intonation,²⁴ and otherwise have the same structure as matrix clauses (276). Matrix questions may also be overtly marked by the demonstrative *laa* in post-verbal position, which acts as a kind of question particle (277a); the same marking is available in embedded questions (277b).²⁵

(276) Koe gu gai mee?
 2SG INC eat thing
 ‘Did you eat?’ (JR-ML-20150611)

²⁴The same clause-final rising intonation is possible for embedded questions, though it seems to be more common to have falling declarative intonation.

²⁵*Laa* is typically used as a spatial or temporal deictic, as described in §3.2.7 and §3.3.7.2. It is possible that the use of *laa* in questions is related to its meaning as a deictic, though this warrants future research.

- (277) a. Ruth e maua **laa** i de llanga mee?
 Ruth IPFV be.able DIST PREP DET weave thing
 ‘Can Ruth weave?’ (JR-ML-20150611)
 ML: ‘The *laa* means it’s automatically a question.’
- b. Au ne ssili ange gi a Ruth [be Soni ne hudi **laa** dahi mamu].
 1SG PFV ask DIR.DIST to PN Ruth COMP.INT Johnny PFV pull.in DIST one fish
 ‘I asked Ruth whether Johnny caught a fish.’ (JR-20231210)

Matrix polar questions seem to have more word order flexibility than matrix declarative clauses: while many polar questions use SVO word order, they also use VSO word order somewhat regularly (278). VSO word order is also possible for embedded questions (279).

- (278) Ne gai de gauligi de gahudi anaahi?
 PFV eat DET child DET banana yesterday
 ‘Did the child eat the banana yesterday?’ (JR-20220627)
- (279) Au ne ssili ange gi a Ruth [be ne hudi Soni dahi mamu].
 1SG PFV ask DIR.DIST to PN Ruth COMP.INT PFV pull.in Johnny one fish
 ‘I asked Ruth whether Johnny caught a fish.’ (JR-20231210)

3.5.1.2 Content questions

Matrix content questions can be formed using two strategies: an in-situ strategy, where a question word appears in typical argument position, and a fronting strategy, where the question word appears at the left edge of the clause. A list of question words in Nukuoro is provided in Table 3.18.

Question word	Gloss
<i>ai</i>	who
<i>aha</i>	what, which
<i>hee</i>	where
<i>aahee</i>	when (future)
<i>anahee</i>	when (past)
<i>gu aha</i>	why
<i>deehee</i>	which, how
<i>beehee</i>	what kind
<i>hia</i>	how many

Table 3.18: Question words

In-situ questions use question words in argument position (280), and can be used for basic questions as well as echo questions.

- (280) a. Mina ne hedae ange gi **ai**?
 Mina PFV meet DIR.DIST to who
 ‘Who did Mina visit?’ (JR-20190704)
- b. Mina ne ogo **aha**?
 Mina PFV pick.fruit what
 ‘What did Mina pick?’ (JR-20190704)

The same in-situ strategy is available for embedded content questions, which are introduced by the interrogative complementizer *be* (281).

- (281) Au e iloo [be Mina ne hagao **aha**].
 1SG IPFV know COMP.INT Mina PFV buy what
 ‘I know what Mina bought.’ (JR-20231210)

Questions that use the fronting strategy have a *pseudocleft* structure, where the question word is a fronted predicate followed by a relative clause; this structure is described and analyzed in more detail in Chapter 5. Fronted interrogative predicates are formed by combining a question word with the focus copula *go*, the indefinite copulas *se/ni*, or an aspect marker. The remainder of the clause is a (genitive) relative clause (see §3.2.9); as such, subjects of questions typically appear in genitive case.

Questions with *ai* ‘who’ are always preceded by the focus copula *go* (282).

- (282) **Go ai** e seni laa i kilaa?
 COP.FOC who IPFV sleep DIST PREP there.DIST
 ‘Who is sleeping over there?’ (ML-20210820)

Possessors can be questioned by using the question word *ai* ‘who’ preceded by a genitive particle and the plural predicative indefinite particle *ni* (283).

- (283) **Ni o ai** tinana ne hulo laa gi de hale golea?
 COP.PL GEN.O who DET.mother PFV go.PL DIST to DET house goods
 ‘Whose mother went to the store?’ (JR-20200518)

The word *aha* ‘what’ is typically preceded by the indefinite copulas *se* or *ni*, which are singular and plural, respectively (284a-b), but it may also be preceded by the focus copula *go* (284c). Using *go* implies that the speaker is asking about one item out of a predefined set of items, such as a grocery list (similar to English ‘which’).

- (284) a. **Se aha** aau ne hagao?
 COP.SG what 2SG.GEN.A PFV buy
 ‘What (SG) did you buy?’ (JR-20190704)
- b. **Ni aha** aau ne hagao?
 COP.PL what 2SG.GEN.A PFV buy
 ‘What (PL) did you buy?’ (JR-20190704)

- c. **Go (de) aha** aau ne hagao?
 COP.FOC DET what 2SG.GEN.A PFV buy
 ‘What/which did you buy?’ (JR-20190704)
 JR: ‘This refers to a list of materials to be purchased, then among the list, you wanted to know what I bought from the list.’

Questions with *aha* can also have overt nominal restrictors, which appear before *aha* (285).

- (285) **Se mamu aha** aana e lodo laa Soni gi huudia age?
 COP.SG fish what 3SG.GEN.A IPFV want DIST Johnny SBJV pull.in.CIA up
 ‘What fish does she want Johnny to catch?’ (JR-20190531)

Questions with *hee* ‘where’ can be preceded by the general preposition *i*, the locative preposition *gi*, or the focus copula *go*. Questions that use *i hee* are targeting a particular location (286a), whereas questions with *gi hee* are targeting the endpoint of a path of motion (286b). As with *aha* ‘what’, the use of *go* in ‘where’ questions indicates that the speaker has a predetermined set of places in mind, as indicated by the speaker commentary in (286c).

- (286) a. **I hee** d-agu beebaa?
 PREP where DET-1SG.GEN.A book
 ‘Where is my book?’ (JR-20190605)
- b. **Gi hee** olaadeu e hulo ai nei?
 to where 3SG.GEN.O IPFV go.PL OBL PROX
 ‘Where are they going?’ (JR-20200527)
- c. **Go hee** olaadeu e hulo ai nei?
 COP.FOC where 3SG.GEN.O IPFV go.PL OBL PROX
 ‘Where are they going?’ (JR-20200527)
 JR: ‘Let’s say the ship will go to Sapwuahfik, Nukuoro, and Kapinga... if you know those three places and you want to know which, *go hee*.’

There are two question words for ‘when’: *aahee*, which indicates that the intended time is in the future (287a), or *anahee*, which indicates that the intended time is in the past (287b). Both *aahee* and *anahee* are typically preceded by the focus copula *go*, though *go* can also be omitted. *Aahee* and *anahee* cannot be preceded by the indefinite copula *se* (288).

- (287) a. **(Go) aahee** olaadeu e hulo ai gi Kolonia?
 COP.FOC when.FUT 3PL.GEN.O IPFV go.PL OBL to Kolonia
 ‘When are they going to Kolonia?’ (JR-20230906)
- b. **(Go) anahee** oou ne gai mee ai?
 COP.FOC when.PST 2SG.GEN.O PFV eat thing OBL
 ‘When did you eat?’ (JR-20230906)
- (288) a. ***Se aahee** olaadeu e hulo ai gi Kolonia?
 COP.FOC when.FUT 3PL.GEN.O IPFV go.PL OBL to Kolonia
 ‘When are they going to Kolonia?’ (JR-20230906)

- b. ***Se anahee** oou ne gai mee ai?
 COP.FOC when.PST 2SG.GEN.O PFV eat thing OBL
 ‘When did you eat?’ (JR-20230906)

The phrase *gu aha* ‘why’ is comprised of the inchoative aspect particle *gu* plus the question word *aha* ‘what’ (289). Since *gu aha* is already a predicate, it cannot be preceded by *se/ni* or *go*.

- (289) **Gu aha** gu aahe mai ai laa gooluu?
 why INC return.PL DIR.PROX OBL DIST 2DU
 ‘Why did you return here?’ (Gininga, 10-1, line 160)

The question word *deehee* ‘which, how’ does not appear with any predicate-forming or aspectual element before it, and it is typically followed by a noun (290). *Deehee* generally means ‘which’; when followed by the noun *hai* ‘way’, it can also be used to mean ‘how’ (290b).

- (290) a. **Deehee** de gai oou e lodo ai?
 which DET food 2SG.GEN.O IPFV want OBL
 ‘Which food do you want?’ (JR-20190607)
- b. **Deehee** doo hai ne gai mee ai?
 how DET-2SG.GEN.O way PFV eat thing OBL
 ‘How did you eat?’ (lit. ‘Which was your way of eating?’) (JR-ML-20150611)

The question word *beehee* ‘what kind’ is a nominal modifier, which appears after a fronted nominal introduced by the indefinite copula *se/ni* or the focus copula *go* (291).

- (291) **Se gulu beehee** a Ruth ne hili?
 COP.SG breadfruit what.kind GEN.A Ruth PFV choose
 ‘What kind of breadfruit did Ruth choose?’ (e.g., cooked, small, ripe) (JR-20190704)

The question word *hia* ‘how many’ may be preceded by an aspect marker (292a) or a predicative indefinite marker *se/ni* (292b) and is always followed by a noun. When combining with a human noun, the human classifier *dogo* must appear before *hia* (292a).

- (292) a. **E dogo hia gauligi suguulu** ne dau beebaa anaahi?
 IPFV CL.HUM how.many child school PFV read book yesterday
 ‘How many students were reading yesterday?’ (JR-20230420)
- b. **Se hia mamu** a Soni ne gaamai?
 COP.SG how.many fish GEN.A Johnny PFV bring
 ‘How many fish did Johnny bring?’ (JR-20190704)

Embedded content questions may also utilize a fronting strategy (293), where the interrogative complementizer *be* precedes the fronted *wh*-element.

- (293) Au e iloo [be **ni aha** aau ne gai].
 1SG IPFV know COMP.INT COP.PL what 2SG.GEN.A PFV eat
 ‘I know what you ate.’ (JR-ML-20150611)

Fronted questions show the same restrictions on movement found in relative clauses (see §3.2.9). When transitive subjects are questioned, the verb obligatorily appears with the suffix *-(C)ia* and/or the post-verbal particle *ina* (294); when oblique arguments are questioned, they obligatorily undergo resumption with the post-verbal oblique anaphor *ai* (295).

- (294) a. Denga gaagoo ne gai de gaadinga.
 DET.PL chicken PFV eat DET coconut
 ‘The chickens ate the coconut.’ (ML-20210709)
- b. Go ai ne gai-**na** de gaadinga?
 COP.FOC who PFV eat-CIA DET coconut
 ‘Who ate the coconut?’ (ML-20210709)
- (295) a. Soni gu maga de buu gi ssaalinga.
 Johnny INC throw DET ball to DET.road
 ‘Johnny threw the ball to the road.’ (JR-20220704)
- b. Go hee a Soni ne maga **ai** de buu?
 COP.FOC where GEN.A Johnny PFV throw OBL DET ball
 ‘Where did Johnny throw the ball?’ (JR-20220704)

Prepositions vary as to whether they can undergo fronting with the question word (i.e., pied piping) or whether they can remain in base position. The prepositions *i* and *gi* can undergo fronting, as seen in the examples in (286); however, *i* and *gi* cannot be stranded in base position (296b) unless they are followed by the resumptive element *aagena* (296c).

- (296) a. Soni ne dau ange gi a Ruth.
 Johnny PFV collide DIR.DIST to PN Ruth
 ‘Johnny ran into Ruth.’ (JR-20200526)
- b. *Go ai a Soni ne dau ange (ai) **gi**?
 COP.FOC who GEN.A Johnny PFV collide DIR.DIST OBL to
 Intended: ‘Who did Johnny run into?’ (JR-20230427)
- c. Go ai a Soni ne dau ange **gi aagena**?
 COP.FOC who GEN.A Johnny PFV collide DIR.DIST to them
 ‘Who did Johnny run into (them)?’ (JR-20200526)

Other prepositions show different behavior: *matali* ‘with’ can undergo fronting with the question word or remain in base position (297); *mo/ma* ‘for’ cannot be fronted or stranded, and instead remains in its base position followed by a genitive resumptive pronoun (298).

- (297) a. **Matali ai** oou ne seese ai?
 with who 2SG.GEN.O PFV walk OBL
 ‘With who did you walk?’ (JR-20200526)
- b. Go ai oou ne seese ai **matali**?
 COP.FOC who 2SG.GEN.O PFV walk OBL with
 ‘Who did you walk with?’ (JR-20200526)

- (298) a. ***Mo ai** o Soni ne haga-duu ange ai de hale?
 BEN.O who GEN.O Johnny PFV CAUS-stand DIR.DIST OBL DET house
 ‘For who did Johnny build the house?’ (JR-20230427)
- b. *Go ai o Soni ne haga-duu ange ai de hale **mo**?
 COP.FOC who GEN.O Johnny PFV CAUS-stand DIR.DIST OBL DET house BEN.O
 Intended: ‘Who did Johnny build the house for?’ (JR-20200526)
- c. Go ai o Soni ne haga-duu ange ai de hale **mo-ona**?
 COP.FOC who GEN.O Johnny PFV CAUS-stand DIR.DIST OBL DET house BEN-3SG.GEN.O
 ‘Who did Johnny build the house for?’ (JR-20200526)

3.5.2 Focus

Focus constructions are formed using the same structures as questions: focused elements may appear in-situ, where they are prosodically marked, or as the fronted predicate of a pseudocleft, where they must be preceded by the focus copula *go* or the indefinite copula *se/ni*.

In-situ focused elements are marked by higher pitch and louder volume (299), notated here using capital letters.

- (299) a. Go ai a Mina ne heda ange aagena?
 COP.FOC who GEN.A Mina PFV meet DIR.DIST to.them
 ‘Who did Mina visit?’ (JR-20190704)
- b. Ia ne heda ange gi a RUTH.
 3SG PFV meet DIR.DIST to PN Ruth
 ‘S/he visited RUTH.’ (JR-20190704)

More commonly, focus constructions use a pseudocleft fronting strategy, where the focused element is a predicate followed by a (genitive) relative clause (§3.2.9). Fronted nominals must be preceded by a predicate-forming element, such as *go* (300a). As the answer to a question, the focused element may appear on its own without a relative clause (300b)

- (300) a. Go Ruth aana ne heda ange aagena.
 COP.FOC Ruth 3SG.GEN.A PFV meet DIR.DIST to.them
 ‘RUTH is who she visited.’ (JR-20190704)
- b. Go Ruth.
 COP.FOC Ruth
 ‘RUTH.’ (JR-20190704)

Full nominals may appear fronted with *se/ni* or with *go* (301). When a focus construction is the answer to a question, it must the same particle that was used for the question word (302).

- (301) a. **Se goede** aana e lodo laa Soni gi huudia age.
 COP.SG octopus 3SG.GEN.A IPFV want DIST Johnny SBJV pull.in.CIA up
 ‘AN OCTOPUS is what she wants Johnny to catch.’ (JR-20190531)

- b. **Go de goede** aana e lodo laa Soni gi huudia age.
 COP.FOC DET octopus 3SG.GEN.A IPFV want DIST Johnny SBJV pull.in.CIA up
 ‘THE OCTOPUS is what she wants Johnny to catch.’ (JR-20190531)
- (302) a. **Ni aha** a Mina ne ogo?
 COP.PL what GEN.A Mina PFV pick
 ‘What did Mina pick?’ (JR-20190704)
- b. {**Ni / #go** } gulu golee.
 COP.PL COP.FOC breadfruit seed
 ‘Seeded breadfruit.’ (JR-20190704)

Like relative clauses (§3.2.9) and questions (§3.5.1.2), focus constructions show two restrictions on movement: focusing a transitive subject requires the verb to appear with *-Cia/ina* morphology (303), and focusing an oblique requires resumption using the post-verbal oblique anaphor *ai* (304).

- (303) a. Soni ne baalasi tenggii.
 Johnny PFV shine DET.light
 ‘Johnny shone the flashlight.’ (JR-20200526)
- b. Go Soni ne **balasia ina** tenggii.
 COP.FOC Johnny PFV shine.CIA INA DET.light
 ‘JOHNNY shone the flashlight.’ (JR-20200526)
- (304) a. De gaaduu e noho i lote vai.
 DET dog IPFV sit PREP inside.DET water
 ‘The dog is sitting in the water.’ (JR-20190705)
- b. Go lote vai oona e noho **ai**.
 COP.FOC inside.DET water 3SG.GEN.O IPFV sit OBL
 ‘THE WATER is what he’s sitting in.’ (JR-20190705)

The phrase *donu huu* ‘only’ is often associated with *go*-marking and fronting (305a), though nominals modified by *donu huu* are not obligatorily marked by *go* (305b).

- (305) a. **Go** denga mamu **donu huu** aana ne gai.
 COP.FOC DET.PL fish only 3SG.GEN.A PFV eat
 ‘ONLY FISH is what he ate.’ (JR-20190704)
- b. Ia ne gai denga mamu **donu huu**.
 3SG PFV eat DET.PL fish only
 ‘He ate only fish.’ (JR-20190704)

3.5.3 Topic

Topical arguments can appear at the left edge of the clause, followed by a prosodic break (306). The topic argument are typically associated with a pronoun in its base position.

- (306) a. **Buasalai**, ga dee hano naa huu au, gai **ia** e dee hano hogi.
 Buasalai PRSP NEG go IRR when 1SG then 3SG IPFV NEG go.SG also
 ‘(As for) Buasalai, if I don’t go, he won’t go either.’ (Gininga, 10-1, line 36)
- b. Gai **taane nei**, au e tilo nei d-**ono** ada...
 so DET.man PROX 1SG IPFV look.at PROX DET-3SG.GEN.O picture
 ‘So this man, I’m looking at his picture...’ (JR-20190705)

Resumption for left-edge topics is obligatory, except where *pro*-drop is otherwise possible. For example, oblique topics must be resumed by the oblique anaphor *ai* (307); resumption for third person topics is optional (308b), reflecting the fact that third person pronouns may undergo *pro*-drop (§3.2.1).

- (307) a. Au gu gaavange e dolu beebaa gi Soni, Ruth, ma Nuinui.
 1SG INC give IPFV three book to Johnny Ruth and Nuinui
 ‘I gave three books to Johnny, Ruth, and Nuinui.’ (JR-20230209)
- b. Gai **Soni**, au ne gaavange *(**ai**) d-agu baibele.
 so Johnny 1SG PFV give OBL DET-1SG.GEN.A bible
 ‘(As for) Johnny, I gave him my bible.’ (JR-20230209)
- (308) a. Gimaau ma Lydia ne gidee dahi gaaduu.
 1DU.GEN.A and Lydia PFV see one dog
 ‘Lydia and I saw a dog.’ (JR-20220704)
- b. Gai **a Lydia**, de gaaduu ga osooso (**ia**).
 so PN Lydia DET dog PRSP nuzzle 3SG
 ‘(As for) Lydia, the dog nuzzled (her).’ (JR-20220704)

Topical arguments precede fronted focused arguments marked with *go* (309).

- (309) **De beebaa**, go Soni ne gaav-ange gi a Ruth.
 DET book COP.FOC Johnny PFV give-DIR.DIST to PN Ruth
 ‘(As for) the book, JOHNNY is who gave it to Ruth.’ (JR-20190603)

Chapter 4

Nukuoro clause structure

This chapter provides a description and analysis of matrix clause structure in Nukuoro, which is best understood within the larger Polynesian context. Research on the syntax of Polynesian languages has focused heavily on clause structure, which shows a number of typologically unusual properties. Polynesian languages overwhelmingly show verb-initial (V1) word orders, as shown below in Samoan (1) and Hawaiian (2). In these and subsequent examples, the verb is underlined.

- (1) Sā tuli e le tamāloa lono atali'i.
 PST chase ERG SPEC man his son
 'The man chased his son.'

(Samoan; Collins 2017:6)

- (2) Ua ku'ai 'o Kekoa i ka i'a.
 PERF buy SUBJ Kekoa OBJ the fish
 'Kekoa bought a fish.'

(Hawaiian; Medeiros 2013:72)

The derivation of verb-initiality has garnered a lot of interest cross-linguistically, with analyses deriving V1 orders via head movement of V^0 (Otsuka 2005; Clemens 2014, 2019; Clemens & Coon 2018; Bossi & Diercks 2019) or by phrasal movement of the predicate (Kayne 1994; Rackowski & Travis 2000; Massam 2001; Aldridge 2004; Chung 2005; Coon 2010; Kalin 2014; Collins 2017; van Urk 2022). Both derivations of verb-initiality have been well-supported in different languages, with Polynesian languages also receiving both treatments.

A second, related topic concerns the fact that many Polynesian languages show ordering alternations with objects of different sizes: some objects appear to undergo fronting with the predicate, while others cannot appear within the fronted constituent. In Niuean, for instance, DP objects obligatorily appear after the post-verbal subject, clearly discontinuous with the rest of the VP, while bare and modified NP objects obligatorily appear adjacent to the verb (3). This pattern has been described as pseudo noun incorporation (Massam 2001).

(3) Pseudo noun incorporation in Niuean

a. Ne kai he pusi ia **e moa**.

PST eat ERG cat that ABS bird

'That cat ate the chicken.'

(Massam 2001:155)

b. Ne inu **kofe kono** a Mele.

PST drink coffee bitter ABS Mele

'Mary drank bitter coffee.'

(Massam 2001:158)

Pseudo noun incorporation can be distinguished from true noun incorporation in its ability to apply to phrasal NPs. This alternation is classically attributed to restrictions on object shift: DP objects obligatorily shift, vacating the VP before it fronts, while NP objects fail to shift and undergo fronting with the rest of the VP (Massam 2001). In addition to Niuean, similar observations have been made about other Polynesian languages, like Hawaiian (Medeiros 2013) and Samoan (Collins 2017), as well as languages outside of the Polynesian family, such as Ch'ol (Coon 2010).

With this context in mind, this chapter provides an analysis of the clause structure of Nukuoro, which differs from most other Polynesian languages with respect to word order: SVO is the pragmatically-neutral word order, as shown in the examples in (4).

(4) a. De gauligi ne anu.

DET child PFV dance

'The child danced.'

(ML-20210709)

b. Tama daane laa ga gidee dahi haonga.

DET.child boy DIST PRSP see one nest

'That boy saw a nest.'

(ML-20160628)

At first glance, this word order reflects the standard base-generated order of arguments, with the object as the complement of the verb and subjects introduced by higher functional structure. Upon a closer look, however, I argue that basic SVO order in Nukuoro is derived via several steps of movement, which brings the derivation of Nukuoro word order more in line with proposals made for other Polynesian languages. First, there are several contexts in Nukuoro that permit or require verb-initial orders, including adjunct clauses (5) and nominalized clauses (6). For this reason, the word order of Nukuoro can be described as SVO-VSO alternating.

(5) [Ne llanga goe denga gede anaahi]...

PFV weave 2SG DET.PL basket yesterday

'If you wove the baskets yesterday...'

(JR-20220627)

(6) Ga lava huu [de hua ange a de gau laa de mee]...

PRSP finish when DET sing DIR.DIST GEN.A DET people DIST DET thing

'When those people finished singing the praises...' (Haini, Carroll 1980, 12-1, line 81)

Using evidence from the position of predicates and predicate modifiers, I argue that all Nukuoro clauses, whether SVO or VSO, involve a step of predicate fronting: the VP raises to a position just below Infl (and optionally Neg). In proposing phrasal movement of the predicate in Nukuoro, I

follow accounts of verb-initiality in Hawaiian (Medeiros 2013) and Samoan (Collins 2017), as well as van Urk's (2022) account of predicate fronting in the SVO Polynesian language Imeré.

Second, Nukuoro shows ordering asymmetries between the fronted predicate and objects of different sizes. In Nukuoro, objects with and without determiners may appear outside of the fronted predicate (7a). Crucially, however, only bare noun objects may appear within the VP in Nukuoro: determinerless objects with modifiers cannot appear within the VP (7b). This behavior contrasts with what has been described in Niuean, Hawaiian, and Samoan, where determinerless modified objects can appear within the fronted predicate.

- (7) a. De-laa de hale aagu e [VP dunu ai] **(denga) mamu (nnui)**.
 DET-DIST DET house 1SG.GEN.A IPFV cook OBL DET.PL fish big.PL
 'That's the house where I cook (the) (big) fish.' (JR-20200505)
- b. De-laa de hale aagu e [VP dunu (*denga) **mamu (*nnui)** ai].
 DET-DIST DET house 1SG.GEN.A IPFV cook DET.PL fish big.PL OBL
 'That's the house where I cook (*the) (*big) fish.' (JR-20200505)

To capture this behavior, I propose that all Nukuoro objects, whether they are NPs or DPs, undergo object shift, which targets an inner specifier of vP prior to predicate fronting. Object movement applies prior to predicate fronting, meaning that shifted NP and DP objects do not undergo movement along with the predicate, resulting in the word order in (7a). I argue that the word order in (7b) is a result of true noun incorporation (e.g., Mithun 1984; Baker 1988), where the N^0 object may form a complex head with V^0 and front with the rest of the predicate. This account captures the fact that modified NP objects cannot undergo predicate fronting in Nukuoro, showing that the Nukuoro pattern cannot be analyzed as pseudo incorporation (cf. Massam 2001).

Finally, I discuss the position of pre-verbal subjects in Nukuoro. While derived subjects are often assumed to occupy Spec,IP, I propose that Nukuoro subjects appear higher in the clausal periphery, namely in Spec,CP, based on two observations. First, pre-verbal subjects are unavailable in IP-sized adjunct clauses, suggesting that they occupy a position higher than Spec,IP, and second, the subjunctive complementizer *gi* obligatorily appears after the pre-verbal subject. I show that despite being in the C domain, Nukuoro subject position has the hallmarks of an A-position, based on evidence from locality and interpretation.

In total, SVO order in Nukuoro derived via three steps of movement: ① movement of the object to an inner specifier of vP ; ② remnant movement of the predicate to a position just below Infl, which I label FP; and ③ movement of the subject to the specifier of CP. The derivation of a Nukuoro SVO clause is schematized in (8).

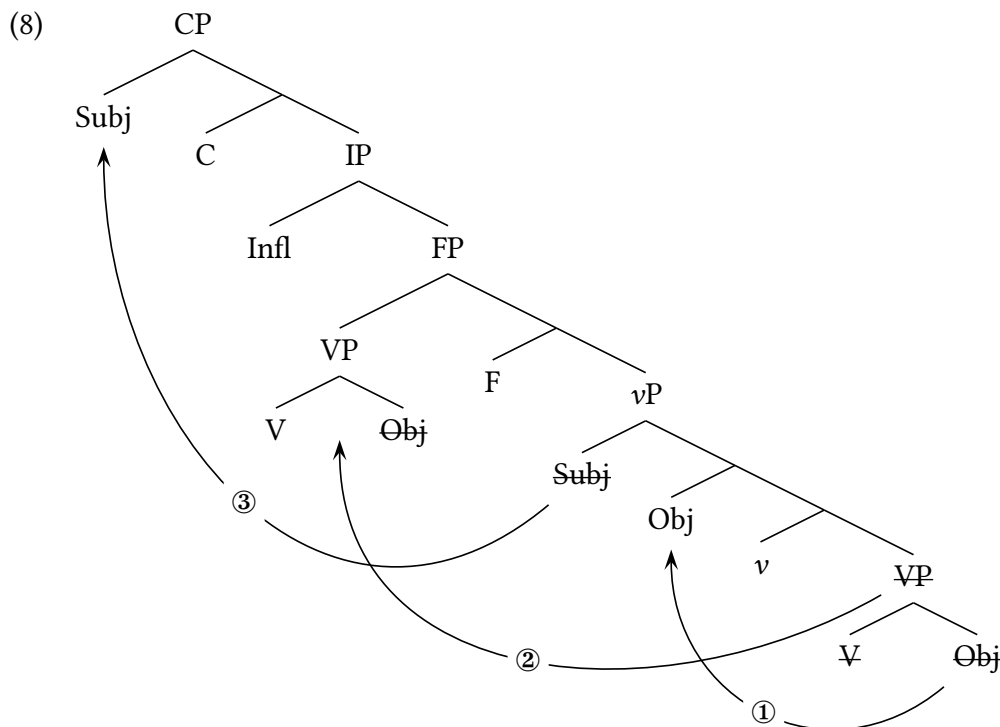

I provide justification for each of these steps of movement in turn, starting with predicate fronting. Section 4.1 describes and analyzes predicate fronting in Nukuoro, which I characterize as phrasal movement. In section 4.2, I describe the position of objects with respect to the fronted predicate, arguing that Nukuoro shows a pattern of true noun incorporation. Section 4.3 turns to the status of pre-verbal subjects, which I argue are derived via A-movement to Spec,CP.

4.1 Predicate fronting

I propose that all Nukuoro clauses—whether they show SVO or VSO word order—involve an intermediate step of predicate fronting, which explains the existence of predicate-initial orders in the language. In doing so, I follow work by van Urk (2022) on the related Polynesian Outlier language Imere, which is claimed to have predicate fronting and SVO order, and unify the analysis of Nukuoro with accounts of predicate-initial order in Niuean, Hawaiian, and Samoan (Massam 2001; Medeiros 2013; Collins 2017).

While SVO order is the most pragmatically neutral word order in Nukuoro, predicate-initial orders are also available in several contexts. For instance, predicate-initial orders are more commonly found in a number of dependent clause types, including conditional adjunct clauses (9a), temporal adjunct clauses (9b), purpose clauses (9c), relative clauses (9d), and nominalized clauses (9e). These clauses begin with an aspect marker, which is immediately followed by the lexical

predicate (underlined below) and any predicate modifiers.¹ The predicate is then followed by the subject (bolded below) and any other arguments or adjuncts.

- (9) a. [Ga dee hano naa huu **au**], gai ia e dee hano hogi.
 PRSP NEG go IRR when 1SG then 3SG IPFV NEG go also
 ‘If I don’t go, he won’t go either.’ (Gininga, Carroll 1980:1)
- b. [Ga haanau mai huu **Leibua**], se gauligi daane ange hogi.
 PRSP give.birth DIR.PROX when Leibua COP.SG child male DIR.DIST also
 ‘When Leibua gave birth, it was a baby boy again.’ (Gininga, 10-1, line 115)
- c. Au e hudi mai denga mamu [e gai mee ai **goe** i laangi alodahi].
 1SG IPFV pull.in DIR.PROX DET.PL fish IPFV eat thing OBL 2SG PREP day all
 ‘I catch fish so that you eat every day.’ (JR-RR-20200505)
- d. de masoaa [ne saabai ai **de gauligi** de gede]
 DET time PFV carry OBL DET child DET basket
 ‘the time that the child carried the basket’ (ML-20210917)
- e. Gu lava i de [hai ange a **de hine** laa de hada].
 INC finish PREP DET fix GEN.A DET woman DIST DET car
 ‘The woman finished fixing the car.’ (JR-20211118)

In these examples, we can observe that the predicate appears after inflectional marking and negation but above the base position of the subject, which I take to be Spec,vP. To capture this ordering, I propose that Nukuoro predicates undergo phrasal movement to a position just below Neg, which I label FP (following, e.g., Massam 2001; Medeiros 2013; Collins 2017). This state of affairs is summarized in (10), which results in predicate-initial word order. In subject-initial orders, I propose that the subject moves higher than the fronted predicate, from Spec,vP to Spec,CP; I address movement to pre-verbal subject position in Section 4.3.

¹The class of predicate modifiers in Nukuoro includes manner adverbs (§3.3.6), the directionals *mai*, *adu*, *ange* (§3.3.5), the temporal deictics *nei*, *naa*, and *laa* (§3.3.7.2), the oblique anaphor *ai* (§3.3.2.3), and the particle *huu*, which is found in adjunct clauses and clauses in the continuative aspect. I assume that all of these elements are VP-internal, explaining their position immediately following the lexical predicate.

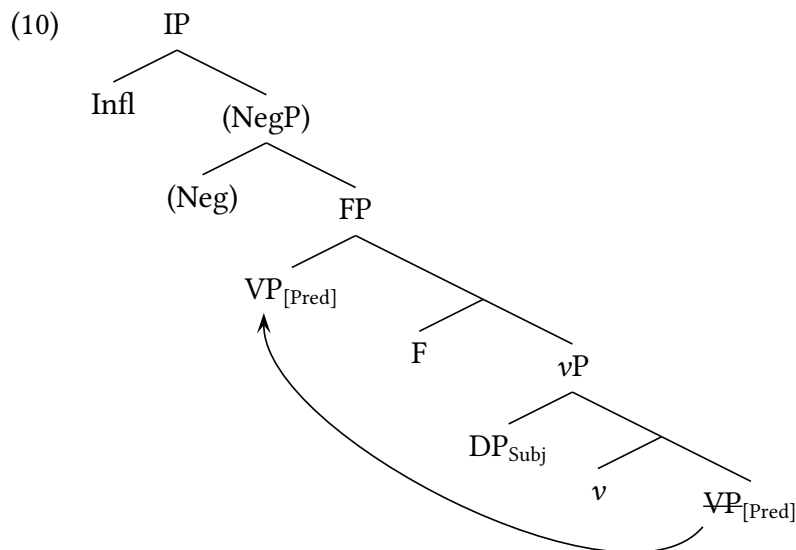

Throughout this section, I use the term “predicate fronting”, rather than “VP fronting”, because Nukuoro allows many different kinds of phrasal constituents to act as predicates, including adjectives (11a), prepositional phrases (11b), definite DPs (11c), and proper names (11d). All of these types of predicates may be preceded by an aspect marker, confirming their predicate status (see §3.4.2 of Chapter 3). Definite DPs in predicative uses are obligatorily preceded by the focus copula *go* (> Proto-Polynesian **ko*), which forms predicates from nominals (e.g., Clark 1976).

- (11) a. *Ia e looloa.*
 3SG IPFV tall
 ‘S/he is tall.’ (JR-RR-20190627)
- b. *Ia nogo i suguulu.*
 3SG IPFV PREP school
 ‘S/he was at school.’ (JR-RR-20190627)
- c. *Taane i kilaa laa go d-ogu damana.*
 DET.man PREP there DIST COP.FOC DET-1SG.GEN.O father
 ‘That man over there is my father.’ (JR-20200610)
- d. *Au gu dee go Vave.*
 1SG INC NEG COP.FOC Vave
 ‘I am no longer Vave.’ (Leaba, 11-8, line 117)

These non-verbal predicates (AP, PP, DP) appear in all the same word orders as verbal predicates: they can be predicates of subject-initial clauses, as shown in (11), but they may appear in predicate-initial clauses as well, where they more clearly undergo fronting. Examples of predicate-initial word order with non-verbal predicates are provided in (12), where they appear in conditional clauses.

- (12) a. [E looloa naa **Nuinui**], ia e maua i de gage i de manusomo.
 IPFV tall IRR Nuinui 3SG IPFV be.able PREP DET climb PREP DET tree
 ‘If Nuinui was tall, she would be able to climb trees.’ (JR-20221013)
- b. [I de hale magi naa huu **Soni**], gai au e madagu.
 PREP DET house sick IRR when Soni then 1SG IPFV afraid
 ‘If Johnny is in the hospital, I will be scared.’ (JR-20221013)
- c. [E dee go de meiolo naa **Soni**], gai ia e noho i U.S.
 IPFV NEG COP.FOC DET mayor IRR Soni then 3SG IPFV live PREP U.S.
 ‘If Johnny was not the mayor, he would live in the U.S.’ (JR-20221013)

Predicate fronting is typically derived in one of two ways: phrasal movement, where the entire predicate XP undergoes fronting to a specifier position (Massam 2001; Medeiros 2013; Collins 2017; van Urk 2022), or head movement, where V^0 undergoes movement, along with any prosodically-incorporated material (Otsuka 2005; Clemens 2014, 2019). I adopt a phrasal movement analysis for Nukuoro for two reasons. First, movement targets a clearly phrasal constituent, including entire VPs (with modifiers) and non-verbal phrasal predicates like PPs; second, the verb and other fronted material do not appear to form a single phonological unit, based on evidence from cross-word phonological processes. These two facts suggest that a head movement approach is not suitable for Nukuoro.

The primary evidence for phrasal predicate fronting in Nukuoro comes from the position of VP-internal material, such as directionals, manner adverbs, and oblique anaphors. In both SVO and VSO orders, these elements appear immediately after the verb, intervening between the verb and any post-verbal arguments (13-14).

- (13) a. Au ne dugu **ange** **maalie** de beebaa gi hongaa teebele.
 1SG PFV put DIR.DIST slowly DET book to top DET.table
 ‘I slowly put the book on the table.’ (JR-20190603)
- b. Au ne dugu **ai** de beebaa.
 1SG PFV put OBL DET book
 ‘I put the book there.’ (JR-20190603)
- (14) a. Ga dugu **maalie** naa huu goe de galauna...
 PRSP put slowly IRR when 2SG DET net
 ‘If you lay the net slowly...’ (JR-20230309)
- b. Ga tau **age ai** huu gilaadeu...
 PRSP land.PL up OBL when 3PL
 ‘When they landed there (on Nukuoro)...’ (JR-20221013)

On standard clause-structural assumptions, it is surprising that material regularly appears between the verb and the object that it selects for in examples like (13)—we would expect adverbs and directionals to appear after the DP object, reflecting their status as VP modifiers. Their position is even more surprising in predicate-initial clauses like (14), where they remain adjacent to the verb and precede the subject and the object.

Phrasal movement of the predicate provides a natural explanation for the position of post-verbal elements, which, as I show below, are located within the VP.² In predicate-initial orders, such as those exemplified in (14), the entire VP undergoes movement to a position above the subject, taking along adverbs, directionals, and anaphors adjoined to or contained within the VP.³ The same fronting mechanism can explain the position of post-verbal elements in SVO orders as well. In Section 4.2, I claim that objects undergo movement out of the VP; all remaining VP-internal material undergoes predicate fronting to a higher position, resulting in the ordering Verb-Particles-Object. This mechanism is schematized in (15).

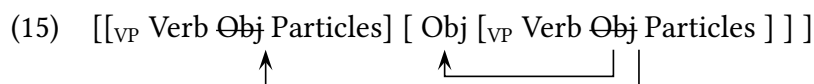

The fronting of directionals is predicted on a phrasal movement account, as directionals are argued to occur within the VP cross-linguistically (Emonds 1972; Neeleman & Weerman 1993; Harley & Noyer 1998; Ramchand & Svenonius 2002). In Nukuoro more specifically, directionals often combine with verbs to yield non-compositional meanings, such as *doo ange* ‘pack’ (literally ‘drop away’) or *manadua age* ‘decide’ (literally ‘think up’), suggesting that verbs and their directionals form a syntactic constituent (following e.g., Chomsky 1993). Additionally, verbs and their directionals may be coordinated (16), providing further evidence that directionals are located within the fronted VP.⁴

- (16) Ia ne [galo **ange**] ma de [hudi **mai**] de mamu.
 3SG PFV look DIR.DIST and DET pull.in DIR.PROX DET fish
 ‘He looked at and pulled in the fish.’ (JR-20221013)

Similarly, manner adverbs obligatorily appear adjacent to the verb (17a), which reflects the assumption that manner adverbs are adjoined within VP. It is impossible for a manner adverb to appear after any verbal arguments or full PP adjuncts (17b). A phrasal movement account correctly predicts that manner adverbs should always undergo fronting with the predicate.

- (17) a. Au ne [dugu ange **maalie**] de beebaa gi hongaa teebele.
 1SG PFV put DIR.DIST slowly DET book to top DET.table
 ‘I slowly put the book on the table.’

²I also assume that the irrealis marker *naa* and the particle *huu* are contained within the fronted predicate, which explains their position immediately after the verb. It is not as apparent from their function or meaning that these elements should be within the VP: reality status and mood are often assumed to be higher in the clause with other inflectional projections, and *huu* appears in adjunct clauses and in the continuative aspect, making its exact function difficult to pin down. While further research is needed, I suggest for the time being that *naa* is a deictic modifier like its counterparts *nei* and *laa* (§3.3.7.2), which has been metaphorically extended to indicate temporal deixis (future tense) and irrealis mood. *Huu*, on the other hand, may be a kind of aspect marking internal to VP, or it may realize the F⁰ head itself which triggers predicate movement.

³I assume that predicate fronting must target the largest segment of the VP, taking along any adjoined material.

⁴For whatever reason, the second conjunct of a verbal coordination must be introduced by the determiner *de*; see §3.4.8.1 of Chapter 3 for more details about this kind of construction.

- b. Au ne [dugu ange] de beebaa (***maalie**) gi hongaa teebele (***maalie**).
 1SG PFV put DIR.DIST DET book slowly to top DET.table slowly
 Intended: ‘I slowly put the book on the table.’ (JR-20221013)

The final element that obligatorily undergoes predicate fronting is the oblique pronoun *ai*, which can be used as an anaphor or resumptive pronoun for any constituent marked with the prepositions *i* or *gi*. This class of obliques includes locations, goals, and instruments, as well as objects of pseudo-transitive predicates (“middles”). While full oblique arguments typically appear clause-finally, after any core arguments (18a),⁵ the pronoun *ai* necessarily fronts with the predicate (18b).

- (18) a. Ga [dae mai] huu ia **gi de henua nei**...
 PRSP arrive DIR.PROX when 3SG to DET island PROX
 ‘When he arrived on this island...’ (Gininga, 10-1, line 9)
- b. Ga [tau age **ai**] huu gilaadeu (*ai)...
 PRSP land.PL up OBL when 3PL OBL
 ‘When they landed there (on Nukuoro)...’ (JR-20221013)

The ordering of lexical predicates and their modifiers is easily captured by a phrasal movement account, in which fronting is derived by movement of a predicative XP. For verbal predicates, this equates to movement of the entire VP (often without the object, as will be discussed in §4.2). For non-verbal predicates, I assume, following e.g., Collins (2017), that the constituents VP, DP, AP, and PP may optionally bear the feature [Pred], which allows them to be selected as the complement of *v* and undergo fronting to the specifier of FP (19). To model this, I adopt the Interaction-Satisfaction model of Agree (Deal 2015b), where probes are articulated for the features that they copy back (i.e., interaction) and the features that halt the probe (i.e., satisfaction). F carries a probe which is satisfied by [Pred],⁶ and subsequently moves the element that satisfied it.⁷ I notate this movement condition with ^M, following the convention of Deal (To appear).

⁵I suggest in §4.2 that PPs undergo right-extraposition conditioned by prosodic weight; on this view, prosodically heavy PPs appear displaced to the right, while prosodically light PPs, like the pronoun *ai*, appear in their base position and undergo predicate fronting.

⁶Here and elsewhere, I refrain from specifying an interaction condition for probes whose heads never realize features of the goal. In other words, if there is no overt evidence that a probe copies features of the goal to itself, it is not possible to tell what its interaction condition is.

⁷Since DPs can bear a [Pred] feature, one might wonder whether the probe on F could ever be satisfied by the subject DP. I assume that the distribution of elements with a [Pred] feature is conditioned by selection: *v* obligatorily selects a [Pred]-bearing constituent as its complement, but introduces a non-predicate nominal in its specifier.

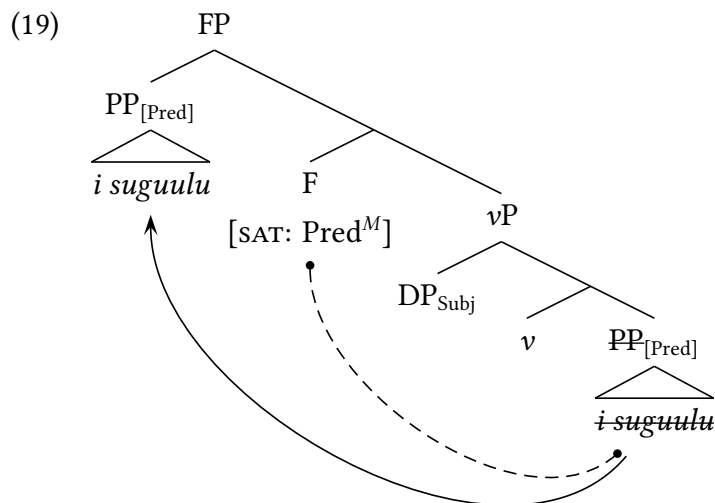

Meanwhile, the fronting of phrasal predicates is more challenging for accounts that use head movement, which must propose non-standard mechanisms to capture this behavior (e.g., Carnie 1995). Otsuka (2005), for instance, proposes that phrasal predicates may be dominated by an X^0 node, allowing them to participate in head movement. By contrast, the analysis proposed here accounts for the fronting of non-verbal predicates using only standard assumptions about phrase structure.

Other head movement accounts capture the movement of predicate modifiers by positing a post-syntactic prosodification mechanism or a requirement that these elements form a single phonological word with the verb (e.g., Otsuka 2005; Clemens 2014, 2019; Clemens & Coon 2018). These accounts do not easily extend to Nukuoro predicate fronting, where the verb and other fronted material do not appear to form a single phonological word. Nukuoro has a productive consonant gemination process, where unstressed vowels are deleted between two identical consonants (see Chapter 3, §3.1.3.4). This process crucially applies at the level of the phonological word: gemination occurs between morpheme boundaries, as shown in (20a-b), as well as across distinct words that are prosodified together (20c-d). Stress is marked with a high accent mark (ˈ); I do not distinguish between primary and secondary stress.

- (20)
- a. *hakaugau* ‘bathe (someone)’
/háka-káukáú/ CAUS-bathe → [hak:aukau]
 - b. *matolu* ‘thirty’
/máta-tóru/ ten.CL-three → [mat:oru]
 - c. *tama* ‘the child’
/te táma/ DET child → [t:ama]
 - d. *lote hale* ‘inside the house’
/róto te háre/ ‘inside DET house’ → [rot:e hare]

Crucially, the consonant gemination process cannot apply between verbs and their adjuncts, suggesting that these elements do not form a prosodic word. For instance, it is possible to create

phonological sequences between fronted verbs and following directionals that meet the structural description for gemination to occur—namely, when the proximal directional *mai* appears after a verb that ends in /m/ and an unstressed vowel, such as *nnamu* ‘smell’ (21). In these cases, however, gemination cannot apply: the surface form is faithful to the input, with the unstressed vowel realized between two identical consonants (22).

- (21) [Ga **nnamu mai** huu denga mamu barbecue], gai au gu hiigai.
 PRSP smell.good DIR.PROX when DET.PL fish barbecue then 1SG INC hungry
 ‘When the barbecue fish smell good (to me), I become hungry.’ (JR-20231210)
- (22) *nnamu mai* ‘smell good (to me)’
 /n:ámu mái/ smell DIR.PROX → [n:ámu mái]
 ↗ [n:ám:ái]

The lack of gemination in this environment suggests that verbs and their adjuncts do not form a prosodic word, which is unexpected on the head movement account.

In short, a phrasal movement account best captures the behavior of Nukuoro fronted predicates, which are phrasal in size and include non-head material such as directionals and manner adverbs. This behavior is found in both verb-initial and SVO word orders, suggesting that predicate fronting occurs in all Nukuoro clauses regardless of surface word order.

4.2 Object shift and noun incorporation

Polynesian languages that are argued to have predicate fronting, such as Niuean, Samoan and Hawaiian, also show a well-known pattern of pseudo noun incorporation (PNI; Massam 2001). In these languages, DP objects must appear after the post-verbal subject, while NP objects must appear adjacent to the verb, before the post-verbal subject; in more analytic terms, NP objects must undergo fronting with the rest of the predicate, while DP objects never undergo predicate fronting. This PNI pattern is shown in Hawaiian in (23): when the object appears to the right of the subject, it must appear with object marking and a determiner (23a); when it appears adjacent to the verb, however, object marking and determiners are ungrammatical (23b).

- (23) Hawaiian pseudo noun incorporation
- a. E [inu ana] ‘o Noelani *(i ke) kope.
 IPFV drink DIR SUBJ Noelani OBJ the coffee
 ‘Noelani is drinking the coffee.’
- b. E [inu (*i ka) kope ana] ‘o Noelani.
 IPFV drink OBJ the coffee DIR SUBJ Noelani
 ‘Noelani is drinking coffee.’ (Medeiros 2013:78)

PNI is crucially distinct from canonical noun incorporation (e.g., Baker 1988) in that incorporated nouns may be modified by adjectives and relative clauses, indicating that they are larger than N^0 . This can be seen in the Samoan example in (24b), for instance, where the adjectival modifier *ula* ‘mischievous’ undergoes incorporation along with the noun *maile* ‘dog’.

(24) Samoan pseudo noun incorporation

- a. E [su'e pea] e le teine **le maile ula**.
 PRES search continually ERG SPEC girl SPEC dog mischievous
 'The girl continually searches for the mischievous dog.'
- b. E [su'e **maile ula** pea] e le teine.
 PRES search dog mischievous continually ERG SPEC girl
 'The girl continually searches for mischievous dogs.' (Collins 2017:3)

As such, the classic interpretation of these facts is that DP objects undergo obligatory movement out of VP (i.e., object shift), while NP objects obligatorily remain within the VP and undergo predicate fronting (Massam 2001; Medeiros 2013; Collins 2017). In other words, object movement only targets DPs in languages that show PNI, a restriction that has been attributed to the need for DPs to receive Case (Massam 2001).

Nukuoro also shows ordering asymmetries between objects of different sizes, a fact which is often obscured by the basic SVO order of the language. In SVO clauses, it is difficult to tell whether the object remains within the VP: the verb and the object are adjacent in SVO orders regardless of the object's structural position, as schematized in (25).

(25) Incorporation pattern in SVO orders

- a. Subject Asp [_{VP} Verb] **Object**
 b. Subject Asp [_{VP} Verb **Object**]

Object position is more clearly diagnosed in predicate-initial orders, where the subject intervenes between the verb and the object (26), or when there is additional material to demarcate the edge of the VP, such as adverbs, directionals, and/or the oblique pronoun *ai* (27).

(26) Incorporation pattern in VSO orders

- a. Asp [_{VP} Verb] Subject **Object**
 b. Asp [_{VP} Verb **Object**] Subject

(27) Incorporation pattern with post-verbal particles

- a. Subject Asp [_{VP} Verb Particles] **Object**
 b. Subject Asp [_{VP} Verb **Object** Particles]

In these two contexts, Nukuoro allows bare nouns to appear immediately after the verb, before post-verbal subjects and other post-verbal particles. In predicate-initial orders, for example, bare noun objects may clearly front with the predicate and precede post-verbal subjects, yielding a word order of VOS (28b).

- (28) a. Ne [_{VP} llanga] goe (**denga**) **gede** anaahi, gai koe gu manuia.
 PFV weave 2SG DET.PL basket yesterday then 2SG INC lucky
 'If you wove the baskets yesterday, you're lucky.'

- b. Ne [VP llanga **gede**] goe anaahi, gai koe gu manuia.
 PFV weave basket 2SG yesterday then 2SG INC lucky
 ‘If you wove baskets yesterday, you’re lucky.’ (JR-20220627)

Crucially, VOS orders are only permitted when the object is a bare noun: DP objects can never precede subjects in verb-initial orders, as shown in (29).

- (29) *Ne [VP llanga **denga gede**] goe anaahi, gai koe gu manuia.
 PFV weave DET.PL basket 2SG yesterday then 2SG INC lucky
 Intended: ‘If you wove the baskets yesterday, you’re lucky.’ (JR-20220627)

Similar facts hold in adjunct extraction contexts, which require the oblique pronoun *ai* to appear after the verb (see §3.3.2.3 of Chapter 3). Bare noun objects may precede or follow *ai* (30), while DP objects may only follow *ai* (31). Assuming that *ai* is contained within the fronted VP (§4.1), this ordering asymmetry indicates that bare noun objects can remain within the VP, while DP objects must appear outside of the fronted VP.

- (30) a. De-laa de hale oogu e [VP dunu ai] **mamu**.
 DET-DIST DET house 1SG.GEN.O IPFV cook OBL fish
 ‘That’s the house where I cook fish.’ (JR-20200505)
- b. De-laa de hale oogu e [VP dunu **mamu** ai].
 DET-DIST DET house 1SG.GEN.O IPFV cook fish OBL
 ‘That’s the house where I cook fish.’ (JR-20200505)
- (31) a. De-laa de hale aagu e [VP dunu ai] **denga mamu**.
 DET-DIST DET house 1SG.GEN.O IPFV cook OBL DET.PL fish
 ‘That’s the house where I cook the fish.’ (JR-20200505)
- b. *De-laa de hale oogu e [VP dunu **denga mamu** ai].
 DET-DIST DET house 1SG.GEN.O IPFV cook DET.PL fish OBL
 ‘That’s the house where I cook the fish.’ (JR-20200505)

The incorporation patterns above could be reduced to a generalization about prosodic weight, rather than nominal structure: one could imagine that prosodically light elements (e.g., bare nouns) may optionally appear to the left of other post-verbal particles, while prosodically heavier elements (e.g., DPs) must appear to the right of those particles. Prosodic weight and nominal structure can be teased apart by observing the behavior of pronouns, which are phonologically light DPs: object pronouns may not appear within the VP (32), suggesting that incorporation is structurally conditioned, not prosodically conditioned.

- (32) a. de hale a denga gauligi e [VP buuludi ai] **au** i laangi alodahi
 DET house GEN.A DET.PL child IPFV hug OBL 1SG PREP day all
 ‘the house where the kids hug me every day’ (JR-20220929)
- b. *de hale a denga gauligi e [VP buuludi **au** ai] i laangi alodahi
 DET house GEN.A DET.PL child IPFV hug 1SG OBL PREP day all
 Intended: ‘the house where the kids hug me every day’ (JR-20220929)
 JR: “That’s very off.”

Furthermore, coordinated bare nouns may undergo incorporation (33), suggesting that incorporation targets bare nouns regardless of their internal structure or phonological size.

- (33) a. de hale oogu e [VP dunu ai] **mamu ma laisi**
 DET house 1SG.GEN.O IPFV cook OBL fish and rice
 ‘the house where I cook fish and rice’ (JR-20230906)
- b. de hale oogu e [VP dunu **mamu ma laisi** ai]
 DET house 1SG.GEN.O IPFV cook fish and rice OBL
 ‘the house where I cook fish and rice’ (JR-20230906)

So far, we have seen that Nukuoro allows bare nouns to appear within the fronted predicate. Bare nouns, however, are structurally ambiguous between nominal heads (N^0) and nominal phrases (NP). The crucial test case concerns determinerless, modified nouns: assuming that modifiers are NP adjuncts, the presence of a modifier forces a phrasal structure. The incorporation behavior of modified objects thus allows us to tease apart pseudo noun incorporation (e.g., Masmam 2001), which incorporates phrasal material, and true noun incorporation (e.g., Mithun 1984; Baker 1988), which only applies to nominal heads.⁸

Unlike other Polynesian languages, Nukuoro does not allow modified objects without determiners to appear within the fronted predicate (34–35). Judgements on these utterances range from ungrammaticality to dispreference.

- (34) a. De-nei de naivi aagu e [VP selesele ai] **(denga) mamu nnui**.
 DET-PROX DET knife 1SG.GEN IPFV slice.RED OBL DET.PL fish big
 ‘This is the knife that I cut (the) big fish with.’ (JR-20220929)
- b. *De-nei de naivi aagu e [VP selesele **mamu nnui** ai].
 DET-PROX DET knife 1SG.GEN IPFV slice.RED fish big OBL
 Intended: ‘This is the knife that I cut big fish with.’ (JR-20220929)
 JR: “The words you used are perfect, but you need to use them in a different position in the sentence.”
- (35) a. De-laa de hale aagu ne [VP llanga ai] **(denga) gede lloa**.
 DET-DIST DET house 1SG.GEN PFV weave OBL DET.PL basket long.PL
 ‘That’s the house where I weave (the) long baskets.’
- b. ??/*De-laa de hale aagu ne [VP llanga **gede lloa** ai].
 DET-DIST DET house 1SG.GEN PFV weave basket long.PL OBL
 Intended: ‘That’s the house where I weave long baskets.’ (JR-20220929)
 JR: “It’s used by a few people, like younger people, but it’s awkward.”

⁸The fact that coordinated bare nouns may incorporate is somewhat challenging for a morphological incorporation analysis, since coordinations are often assumed to be phrasal (e.g., Zhang 2010); more research is needed on the structure of these coordinations in Nukuoro to address this challenge. In any case, the key asymmetry in Nukuoro is this: DPs and NPs must vacate the VP, while N^0 heads can remain in-situ. Any implementation of this fact will suffice to capture the Nukuoro pattern and its deviation from other Polynesian languages.

The following pattern emerges: bare noun objects in Nukuoro may appear within the VP or outside the VP, while DP and NP objects obligatorily appear outside the VP. This pattern is different from attested examples of pseudo noun incorporation, where phrasal material can undergo incorporation and distribution of objects is complementary, with N(P) objects obligatorily appearing within the VP and DP objects obligatorily appearing outside the VP.

I argue that the Nukuoro pattern is best captured by obligatory movement of objects out of the VP before it fronts (i.e., object shift; Holmberg 1986). I propose that *v* in Nukuoro carries a phi probe, which Agrees with the first accessible nominal in its c-command domain—namely, the internal argument—and moves it to its specifier.⁹ Specifically, I propose that Nukuoro objects move to an *inner* specifier of *v*P, “tucking in” below the base position of the transitive subject (Richards 2001). Movement of the object to a position below the transitive subject follows Collins’ (2017) proposal for Samoan and captures two important aspects of Nukuoro word order: DP and NP objects obligatorily follow subjects in predicate-initial orders, and subjects are accessible for further A-movement to pre-verbal position, as I discuss in §4.3. These two properties suggest that subjects remain higher than objects; I discuss this proposal further in Chapter 6 as it relates to syntactic ergativity in Nukuoro.¹⁰

The proposed object shift mechanism is schematized in (36). The probe on *v* will halt when it encounters phi features, implemented here as satisfaction by ϕ . The probe also carries an instruction to move the element that satisfies the probe (notated by M).

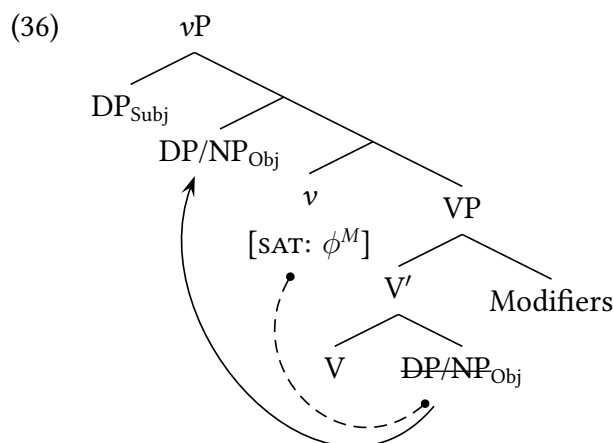

This agreement and subsequent movement targets the closest nominal, regardless of whether that nominal is an NP or a DP. The result is that both NP and DP objects must appear outside of the fronted predicate in Nukuoro.

⁹This implementation requires both DP and NP objects to possess phi features, which must be accessible to the probe on *v*. One way to implement this would be to adopt an analysis of nominal structure where phi features are located on the head of their own projection, PhiP, located between NP and DP (Déchaine & Wiltschko 2002). Nukuoro NPs that undergo movement would then actually be PhiPs, but would still lack a DP layer.

¹⁰In many syntactically ergative languages, objects are argued to move to a position *above* the external argument, which then prevents further extraction of the transitive subject (e.g., Bittner & Hale 1996a; Coon et al. 2014; Clemens & Tollan 2021; Coon et al. 2021). While Nukuoro does show a pattern of syntactic ergativity, I argue that an object inversion analysis is not tenable for a variety of reasons, which I present in Chapter 6.

In cases where bare noun objects do front with the predicate, I propose that this is a true case of noun incorporation, where V^0 and N^0 form a complex head (e.g., Sadock 1980; Baker 1988).¹¹ I assume that the incorporated N^0 is no longer accessible for agreement with v by virtue of being contained within a complex head, preventing the incorporated object from undergoing object shift.¹² The entire predicate then undergoes fronting, resulting in fronting of the verb and the incorporated object. This incorporation, followed by predicate fronting, is schematized in (37).

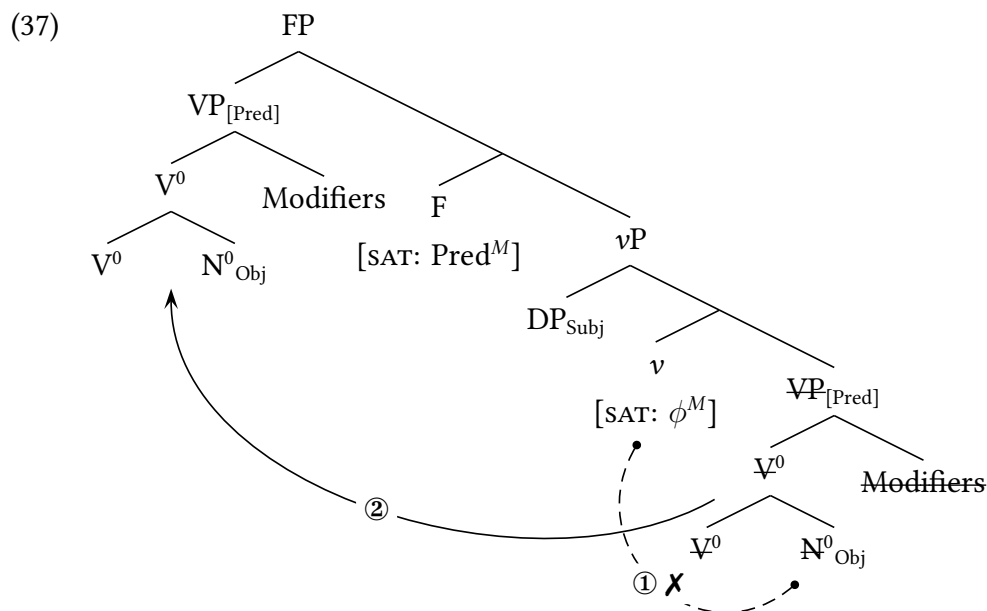

As a final note, it is well-known that while DP/NP objects show ordering asymmetries in predicate fronting languages, PPs and CPs obligatorily appear outside of the fronted predicate (Chung 2005; Massam 2010; van Urk 2022). The same is true of Nukuoro: full PPs and CPs obligatorily appear outside of the fronted VP, to the right of the verb and post-verbal arguments (38).

- (38) a. Ga [VP dae mai huu] ia [PP **gi de henua nei**]...
 PRSP arrive DIR.PROX when 3SG to DET island PROX
 ‘When he arrived at this island...’ (Gininga, 10-1, line 9)
- b. Ga [VP basa adu naa huu] au gi de goe [CP **bolo gu lava**]...
 PRSP speak DIR.MED IRR when 1SG to DET 2SG COMP INC finish
 ‘When I tell you that (I’m) finished...’ (Gininga, 10-1, line 352)

There are a number of syntactic and post-syntactic approaches to the ordering of PPs and CPs in predicate-fronting languages, which van Urk (2022) terms the “stranding problem”.¹³ Any of

¹¹Typologically speaking, Nukuoro noun incorporation is of the “compounding” type (e.g., Mithun 1984; Rosen 1989): it reduces the verb’s transitivity, cannot be doubled by a non-incorporated object, and cannot strand modifiers.

¹²In this structure, the probe on v fails to Agree; I assume, following Béjar (2003) and Preminger (2014), that Agree can fail without crashing the derivation.

¹³Collins (2017), for instance, argues that CPs undergo the same movement to Spec,vP that is available to DP

these accounts could capture the Nukuoro facts; for concreteness, I suggest that PPs and CPs in Nukuoro obligatorily undergo right extraposition (e.g., Ross 1967; Akmajian 1975; Baltin 1978, 1981, 2017), which is conditioned by prosodic factors. Crucially, PP and CP ordering is distinctly different from object ordering in that it is sensitive to phonological weight: full PPs appear outside the fronted predicate (39a), while the resumptive oblique pronoun *ai* always appears within the fronted VP (39b).

- (39) a. Au ne dugu de beebaa **gi hongā teebele**.
 1SG PFV put DET book to top DET.table
 ‘I put the book on the table.’ (JR-20230209)
- b. Au ne dugu **ai** de beebaa (*ai).
 1SG PFV put OBL DET book OBL
 ‘I put the book there.’ (JR-20230209)

These elements arguably involve the same amount of structure: I assume that the oblique pro-form *ai* is structurally a PP, which allows it to be a PP anaphor and resumptive pronoun. The difference between full PPs and the pro-form *ai* is strictly phonological, suggesting that PP extraposition is driven by phonological weight. This data shows that there are two ways to vacate the VP: movement triggered by ϕ , which moves object DPs and NPs, and extraposition, which is phonologically-conditioned and responsible for moving PPs and CPs.

4.3 Subject movement to pre-verbal position

Having accounted for the ordering of predicates and objects in Nukuoro, I now turn to the status of pre-verbal subjects. No previous work has addressed the position of unmarked pre-verbal subjects in Polynesian;¹⁴ unmarked SVO orders are only found in Polynesian Outlier languages, which are relatively endangered and highly understudied. As such, this section provides a preliminary investigation into derived subject position in Nukuoro.

Pre-verbal subjects precede aspect marking and negation, suggesting that they occupy a position higher than Infl. While it would be standard to assume that subjects occupy Spec,IP, I argue instead that Nukuoro pre-verbal subjects move to Spec,CP, driven by a phi probe on C. I adopt an expanded CP model (e.g., Rizzi 1997) with two primary CP layers, which I label CP₁ and CP₂ for simplicity.¹⁵ Pre-verbal subjects move to the specifier of the lower CP₁; while this lower C₁ head is typically null, it is occasionally realized by the subjunctive complementizer *gi*, as I discuss

objects; van Urk (2022) develops a distributed deletion account, where PPs and CPs remain within the VP (and undergo fronting), but copy deletion is governed by post-syntactic principles that linearize elements in order of complexity.

¹⁴By contrast, pre-verbal elements marked with reflexes of Proto-Polynesian *ko have been studied at length, and are typically argued to be focus or topic elements (e.g., Bauer 1991; Pearce 1999; Massam et al. 2006).

¹⁵It may be possible to characterize these projections more precisely: for instance, one could claim that the higher projection corresponds to Rizzi’s (1997) ForceP, since it hosts declarative and interrogative complementizers. I use general labels for these projections to remain as neutral as possible about their function, which necessitates future research. Their exact characterization has no effect on the argumentation I develop in the rest of the dissertation.

in §4.3.1. The complementizers *bolo*, *be*, and *gai* occupy the higher C₂ head above the pre-verbal subject. This state of affairs is schematized in (40).

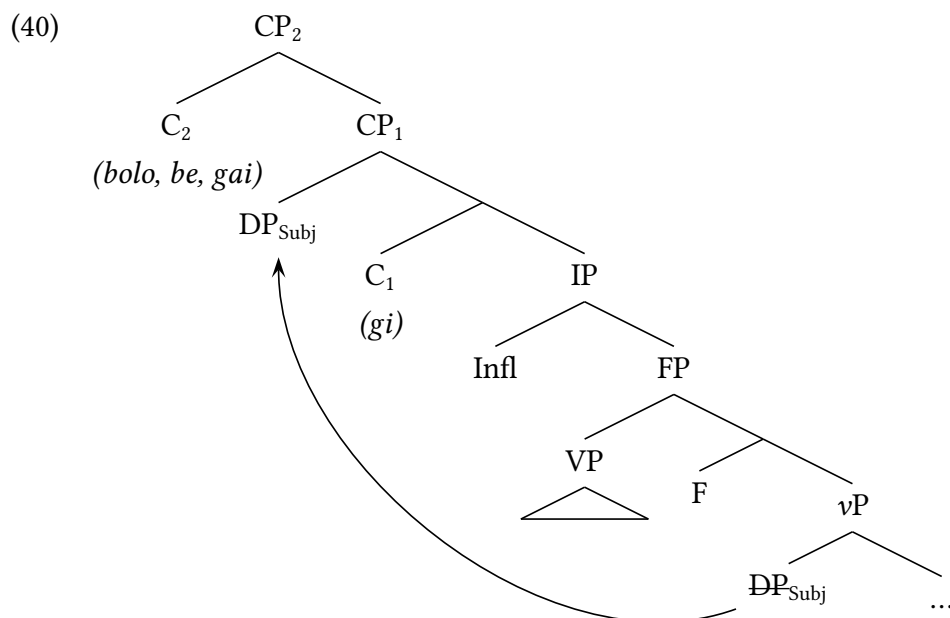

Evidence for the structure in (40) comes from the fact that pre-verbal subjects are ungrammatical in constructions that contain IP but not CP. IP-sized clauses are used for clause chaining constructions, for instance, which are large enough to contain inflectional marking but only allow post-verbal subjects. The same holds true of other kinds of adjunct clauses, including temporal, conditional, and purposive adjuncts. The unavailability of pre-verbal subjects in these constructions suggests that subjects do not occupy Spec,IP. This analysis of Nukuoro subjects is plausible given other aspects of Polynesian clause structure and diachrony, including the assumption that Polynesian TAM morphology undergoes T-to-C movement (Custis 2004; Otsuka 2005; Massam 2010; Collins 2017; Middleton 2021) and the hypothesis that pre-verbal subjects in the Polynesian Outliers are historically derived from a left-edge topic position (Clark 1976; Drummond 2022b).

Spec,CP is traditionally characterized as an \bar{A} -position, associated with focus and/or topic, rather than an argument position. As such, it is important to show that pre-verbal subjects in Nukuoro do not have the interpretive or syntactic characteristics of \bar{A} elements. In Section 4.3.2, I demonstrate that pre-verbal subjects in Nukuoro are not synchronically required to be topical, and they do not show the hallmarks of mixed A/ \bar{A} -movement (van Urk 2015; Colley & Privoznov 2020; Branan & Erlewine 2022): the pre-verbal position is restricted to the most local nominal, preventing other arguments besides subjects from appearing pre-verbally.

In the final subsection, I delve further into the motivation for subject movement in Nukuoro. While movement to subject position is obligatory in declarative matrix and embedded clauses, it is optional in a number of other clause types, including questions, relative clauses, and adjunct clauses. I propose that in the first clause types, the probe on C is obligatory, while in the latter three clause types, the probe on C is optional. I also demonstrate that subject movement is not

driven by traditional mechanisms, such as an EPP requirement on C or a need for the subject to receive Case.

4.3.1 Subjects are in Spec,CP

Nukuoro subjects occupy a position higher than Spec,IP; evidence for this claim comes from IP-sized embedded clauses, which are large enough to host inflectional morphology but may not host pre-verbal subjects. Nukuoro allows clause chaining constructions like (41), where matrix verbs may be followed by additional clauses that have their own TAM markers and argument structure. These clause chains are introduced without a coordinator, and there is no prosodic break between clauses.

- (41) Gai ia ga doo ga han-age gi uda ga siga d-ana ahi...
 then 3SG PRSP drop PRSP go.SG-up to inland PRSP start.fire DET-3SG.GEN.A bonfire
 ‘So he got off and went inland and started his fire...’ (Gininga, 10-1, lines 15-16)

I analyze Nukuoro clause chaining constructions as right-adjoined IPs (Finer 1984, 1985; Broadwell 1997; Lu 2023), as shown in (42).¹⁶ I represent these clauses as adjoining to IP, though this choice is not crucial for the argument I present here. In constructions that contain multiple chained clauses, there may be additional adjuncts to the matrix IP, or the adjoined IP may itself contain an adjunct IP.

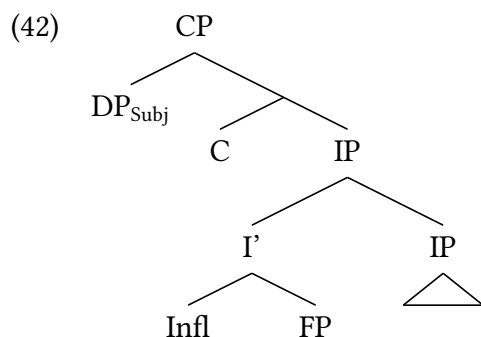

Chained clauses are large enough to include finite inflectional marking yet may not have pre-verbal subjects, suggesting that pre-verbal subjects are not in Spec,IP. While many subjects of chained clauses are *pro*-dropped, overt subjects are permitted—but only if they are post-verbal (43a). It is ungrammatical to use a pre-verbal subject in a clause chaining construction, which does not involve a prosodic break or an overt coordinator (43b).

- (43) a. Gai **de kailuu laa** ga galo adu [gu gidee **ia** de gaaduu]...
 so DET frog DIST PRSP look to.MED INC see 3SG DET dog
 ‘So the frog looked around and he saw the dog.’ (JR-20150624)

¹⁶These constructions could also be analyzed as coordinated IPs with a null coordinator, or a kind of hybrid approach that incorporates adjunction and coordination (Weisser 2013). For the current argument, it is only necessary that these clauses are smaller than CP, which is possible on an adjunction or coordination analysis.

- b. *Gai **de** **kailuu laa** ga galo adu [**ia** gu gidee de gaaduu]...
 so DET frog DIST PRSP look to.MED 3SG INC see DET dog
 ‘So the frog looked around and he saw the dog.’ (JR-20221006)

Pre-verbal subjects are only permitted if the additional clause is introduced by the sequential complementizer *gai* (44a) or if there is a large prosodic break between the two clauses, indicating that they are no longer chained in the same way (44b). I interpret this large prosodic break as delimiting a new utterance, which I notate using a period. I conclude that pre-verbal subjects are permitted, but only when the clause contains additional structure, namely a CP layer.

- (44) a. Gai de kailuu laa ga galo adu gai **ia** gu gidee de gaaduu.
 so DET frog DIST PRSP look to.MED so 3SG INC see DET dog
 ‘So the frog looked around and then he saw the dog.’ (JR-20221006)
- b. Gai de kailuu laa ga galo adu. **Ia** gu gidee de gaaduu.
 so DET frog DIST PRSP look to.MED 3SG INC see DET dog
 ‘So the frog looked around. He saw the dog.’ (JR-20221006)

I take the clause chaining data to suggest that pre-verbal subjects do not occupy Spec,IP, but rather are placed in a higher CP projection that are not present in chained clauses.

An analysis of pre-verbal subjects in Spec,CP fits nicely with established analyses of TAM elements in Polynesian more broadly, which are widely accepted to undergo T-to-C movement (Massam 2000, 2001; Custis 2004; Otsuka 2005; Collins 2017; Middleton 2021). Evidence for T-to-C movement comes from the complementary distribution of certain complementizers with TAM morphology. For example, in Tokelauan, the subjunctive complementizer *ke* never appears with TAM morphology (45); Middleton (2021) argues that this complementarity arises because TAM markers typically undergo movement to the C head that *ke* occupies, which is the lower of two CP layers. This analysis is schematized in (46).

- (45) a. Ko John nae fofou [**ke** (***ka**) tuki e Jess ia Rangi tāeao].
 TOP John TAM want COMP FUT hit ERG Jess ABS Rangi tomorrow
 ‘John wanted Jess to hit Rangi tomorrow.’
- b. Na taumafai ia John [**ke** (***na**) hao te vaka mai te afā].
 PST try ABS John COMP PST escape DEF boat from DEF hurricane
 ‘John tried to escape the ship from the hurricane.’ (Middleton 2021:ex. 22)

(46) Middleton's (2021) analysis of Tokelauan *ke*

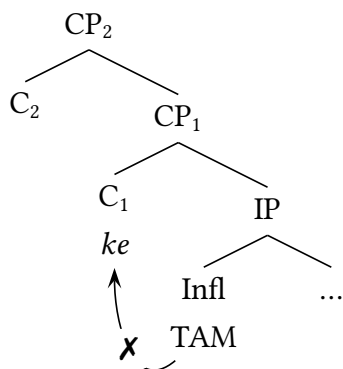

The cognate subjunctive complementizer *gi* in Nukuoro shows similar behavior: it can never co-occur with TAM morphology (47). For this reason, I follow Middleton (2021) and assume that *gi* occupies a lower C head in Nukuoro,¹⁷ which selects for a null, non-finite form of Infl.¹⁸ This proposal is consistent with the analysis of subjunctive clauses presented in Chapter 7, where I argue that they lack Case assignment from Infl.

(47) Au ne lodo (bolo) Mina gi (*ne / *nogo) seni anaahi.
 1SG PFV want COMP Mina SBJV PFV PST.IPFV sleep yesterday
 'I wanted Mina to {sleep / *have slept / *be sleeping} yesterday.' (JR-20210923)

The structural position of subjunctive *gi* is relevant to the present argument because *gi* obligatorily appears after pre-verbal subjects, as seen in (47): if *gi* occupies a low C position, pre-verbal subjects must occupy a higher position, which I take to be the lower Spec,CP. The relative positions of complementizers and pre-verbal subjects are presented in (48).

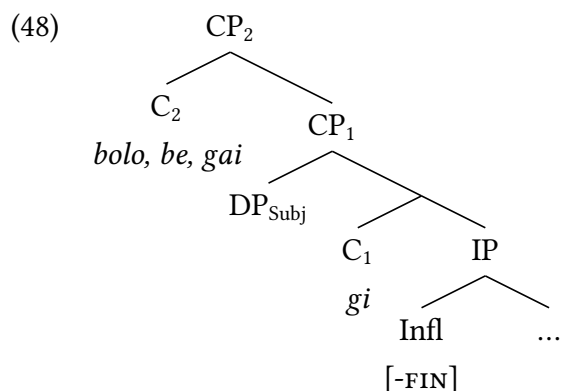

¹⁷Alternatively, *gi* could realize non-finite Infl itself; I adopt a complementizer analysis because it aligns with analyses of the subjunctive marker across Polynesian.

¹⁸For lack of additional evidence, I refrain from making any claims about whether TAM markers regularly undergo Infl-to-C movement in Nukuoro. I simply note that this claim is fully compatible with an analysis of pre-verbal subjects in Spec,CP₁.

Finally, a high position for Nukuoro subjects is corroborated by the idea that pre-verbal subjects originated in the Polynesian Outliers as left-edge hanging topics (Clark 1976; Drummond 2022b), which occupied a position in the left periphery. In some related languages, such as Tuvaluan (Besnier 1986), unmarked pre-verbal elements are synchronically topical: any topical argument may appear in this position, including objects, and these elements are obligatorily resumed by a case-marked pronoun in post-verbal position.

- (49) **Ttoeaina**₁ koo see matea **nee ia**₁ se mea e tasi.
 DET.old.man INC NEG see ERG he a thing IPFV one
 ‘The old man, he can no longer see anything.’ (Tuvaluan; Besnier 2000:281)

In Nukuoro, these unmarked topics have been reanalyzed as subjects (Drummond 2022b), but their position in the clausal periphery has been maintained. In the next section, I show that while pre-verbal subjects originated from topics, they have undergone full reanalysis in Nukuoro and can no longer be synchronically analyzed as hanging topics.

4.3.2 Pre-verbal subjects are not hanging topics

In light of the proposal that Nukuoro subjects occupy Spec,CP, one might wonder whether pre-verbal subject position is truly an A-position. For instance, we could consider a derivation like (50), where unmarked preverbal arguments are actually analyzed as left-edge hanging topics. On this analysis, the basic word order of Nukuoro would actually be VSO in all clauses, and so-called preverbal “subjects” would be \bar{A} -elements.

- (50) *Hanging topic analysis*
 $[_{\text{TopP}} \text{DP} \dots [_{\text{VP}} \text{V Adjuncts}] [_{\text{vP}} \text{pro}_{\text{Subj}} \text{DP}_{\text{Obj}} \text{v} \dots]]$
 ↑ ----- binding ----- ↑

I show that several predictions of this analysis are not borne out in Nukuoro, concerning the locality profile of movement to pre-verbal position, resumption facts, and constraints on topical interpretation, maintaining the view that pre-verbal subjects are A-elements.

First, if the pre-verbal position were an \bar{A} -position, we would predict that any topical argument, regardless of grammatical role, could appear in the pre-verbal position. This is not the case in Nukuoro: the pre-verbal position may *only* be occupied by subjects. No other elements can appear in the pre-verbal position, including direct objects (51a), locative PPs (51b), and nominal adjuncts like *anaahi* ‘yesterday’ (51c).

- (51) a. ***De gahudi** ne gai de gauligi.
 DET banana PFV eat DET child
 Intended: ‘The child ate the banana.’ (JR-20220627)
 JR: ‘Sounds like it’s the banana that’s eating the baby.’
 b. ***I hongaa teebele** ne dugu (ai) au de beebaa.
 PREP top DET.table PFV put OBL 1SG DET book
 Intended: ‘I put the book on the table.’ (JR-20220627)

- c. * **Anaahi** ne hai gimaadeu dahi daonga.
 yesterday PFV do/make 1PL.EXCL one party
 Intended: ‘Yesterday we had a party.’ (JR-20220627)

In other words, movement to pre-verbal position cannot be long-distance: it must target the closest eligible nominal, namely the intransitive or transitive subject. This behavior contrasts with documented examples of mixed A/ \bar{A} -movement, where any topical (nominal) element may appear in “subject” position (see, e.g., van Urk 2015; Colley & Privoznov 2020). Rather, Nukuoro subjects show the locality profile of A-movement.

Second, based on the behavior of left-edge topics within Polynesian, we would expect topics to allow resumption in post-verbal position. Nukuoro pre-verbal subjects do not allow resumption, however (52), suggesting that they are not base-generated hanging topics.

- (52) Ruth ne buuludi ange (*ia) Johnny.
 Ruth PFV hug DIR.DIST 3SG Johnny
 ‘Ruth hugged Johnny.’ (JR-20230309)
 JR: ‘The *ia* makes the sentence awful, because it’s double, *Ruth* and *ia*.’

It is worth noting that there is a dedicated left dislocated topic position in the language, which is distinct from the pre-verbal subject position and requires resumption in the expected way. Hanging topics in Nukuoro appear at the left edge of the clause, but they must be followed by a prosodic break (marked by a comma) and must undergo resumption in their base position (53).¹⁹

- (53) Gai au, de gaaduu gu kadi au.
 then 1SG DET dog INC bite 1SG
 ‘And (as for) me, the dog bit me.’ (JR-20220704)

The example in (53) demonstrates that unlike pre-verbal subjects, hanging topics can be used for any argument, including direct objects; furthermore, hanging topics can appear in addition to a pre-verbal subject, showing that these two positions are distinct. The co-occurrence of hanging topics and pre-verbal subjects is particularly striking in examples like (54), where the hanging topic *dogu dinana* ‘my mother’ is resumed by a pronoun in pre-verbal subject position.

- (54) Dogu dinana, ia ne gisagisa mai dahi singilidi mo-ogu.
 DET.1SG.GEN mother 3SG PFV gift.RED DIR.PROX one t-shirt BEN-1SG
 ‘(As for) my mother, she gave me a t-shirt.’ (JR-20210818)

Finally, pre-verbal subjects can be non-referential, a property which is known to be incompatible with topicalization (Reinhart 1981). Quantificational indefinite arguments, which have no direct reference, can appear in pre-verbal subject position (55).

- (55) [Context: I wake up and see that my dog’s food bowl is full.]
Dahi dangada ne haangai de gaaduu.
 one person PFV feed DET dog
 ‘Someone fed the dog.’ (JR-20220704)

¹⁹See §3.5.3 of Chapter 3 for more information about the hanging topic construction.

The same quantificational indefinites are impossible in hanging topic position, as shown in (56), reaffirming that pre-verbal subjects have different interpretive requirements than topics.

- (56) * **Dahi dangada**, ia gu haangai de gaaduu.
 one person 3SG INC feed DET dog
 Intended: ‘Someone, s/he fed the dog.’ (JR-20220704)

More strikingly, (57) shows that pre-verbal subjects can be truly non-referential. Since Nukuoro does not have DP-level negation (e.g., *no one*), the non-referential DP here is an indefinite subject embedded under matrix negation. This non-referential argument appears in pre-verbal position within the embedded clause.

- (57) Au e dee lodo [bolo **dahi dangada** e haangai de gaaduu].
 1SG IPFV NEG want COMP one person IPFV feed DET dog
 ‘I don’t want (for) one person to feed the dog.’ (JR-20220607)
 [$\neg > \exists$] ✓: I want nobody to feed the dog.
 [$\exists > \neg$] ✗: I want someone to feed the dog, but not Ruth.

The fact that pre-verbal subjects can have no reference suggests that the pre-verbal position is not a dedicated topic position.

In short, while Nukuoro subjects developed from hanging topics, it is clear that pre-verbal subject position no longer shows the syntactic or semantic hallmarks of a topic position. Subject movement to Spec,CP has the locality profile, resumption behavior, and interpretation consistent with A-movement.

4.3.3 Modeling subject movement

Thus far, we have seen that Nukuoro subjects occupy a higher position than typical subjects, namely Spec,CP₁, and that subjects undergo A-movement to this position. To capture these facts, I propose that subject movement is driven by a phi probe on C₁, which triggers movement of the closest nominal to its specifier (58).²⁰ In Interaction-Satisfaction terms (Deal 2015b, 2022), the probe on C₁ is satisfied by ϕ , which carries an additional instruction for movement (^M).

²⁰Crucially, I assume that multiple specifiers of the same head are not equidistant (contra, e.g., Chomsky 2000; Longenbaugh & Polinsky 2018).

(58) Movement to pre-verbal subject position

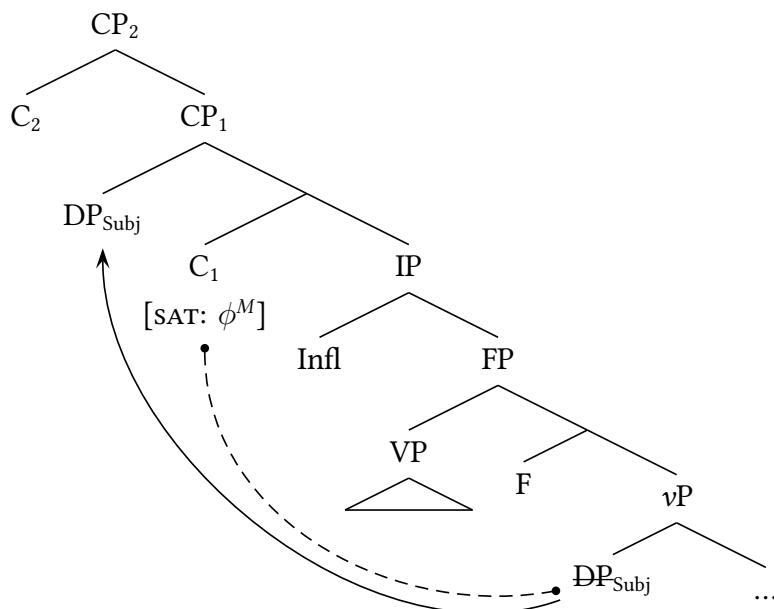

Modeling subject movement becomes less straightforward, however, when we consider a range of clauses: as foreshadowed in §4.1, the availability of pre-verbal subjects differs by clause type. In matrix clauses, SVO order is judged to be obligatory, or at least highly preferred (59).²¹

(59) Obligatory SVO in declarative clauses

- a. **Denga gaagoo** ne gai denga gaadinga.
 DET.PL chicken PFV eat DET.PL mature.coconut
 ‘The chickens ate the coconuts.’ (ML-20210709)
- b. *Ne gai **denga gaagoo** denga gaadinga.
 PFV eat DET.PL chicken DET.PL mature.coconut
 Intended: ‘The chickens ate the coconuts.’ (ML-20210709)

SVO order is also obligatory in complement clauses, where pre-verbal subjects appear after complementizers (60a). It is not possible to use VSO orders in finite complement clauses (60b).

(60) Obligatory SVO in complement clauses

- a. Soni ne tala mai [bolo **Mina** ne doo taagoli].
 Johnny PFV tell DIR.PROX COMP PFV plant Mina DET.taro
 ‘Johnny told me that Mina planted the taro.’ (JR-20230420)

²¹For several speakers I worked with, SVO order is truly obligatory in matrix contexts. A single speaker allows VSO orders in intransitive declaratives, but not in transitive declaratives; while this speaker allows VSO in these contexts, SVO is still highly preferred.

- b. *Soni ne tala mai [bolo ne doo **Mina** taagoli].
 Johnny PFV tell DIR.PROX COMP PFV plant Mina DET.taro
 Intended: 'Johnny told me that Mina planted the taro.' (JR-20230420)

In non-declarative clause types, such as adjunct clauses, questions, and relative clauses, both SVO and VSO orders are readily permitted (61-63). Note that in relative clauses, pre-verbal subjects must appear in genitive case; I provide an account of this pattern in Chapter 5.

(61) SVO and VSO in adjunct clauses

- a. **Koe** ga dugu maalie naa huu de galauna, gai e baba danuaa.
 2SG PRSP place slowly IRR when DET net then IPFV ready good
 'If you lay the net slowly, it will be prepared well.' (JR-20230309)
- b. Ga dugu maalie naa huu **goe** de galauna, gai e baba danuaa.
 PRSP place slowly IRR when 2SG DET net then IPFV ready good
 'If you lay the net slowly, it will be prepared well.' (JR-20230309)

(62) SVO and VSO in questions

- a. **Koe** ne llanga denga gede?
 2SG PFV weave DET.PL basket
 'Did you weave the baskets?' (JR-20200818)
- b. Ne llanga **goe** denga gede?
 PFV weave 2SG DET.PL basket
 'Did you weave the baskets?' (JR-20230504)

(63) SVO and VSO in relative clauses

- a. de masovaa [**olaadeu** ne kada ai]
 DET time 3PL.GEN.O PFV laugh OBL
 'the time that they laughed' (JR-20190620)
- b. de masovaa [ne kada ai **gilaadeu**]
 DET time PFV laugh OBL 3PL
 'the time that they laughed' (JR-20190620)

Finally, SVO order is impossible in certain clauses, such as chained clauses (as discussed previously in §4.3.1) and nominalized clauses. In these contexts, VSO order is obligatory.

(64) Strict VSO in chained clauses

- a. Gai **de kailuu laa** ga galo adu [gu gidee **ia** de gaaduu]...
 so DET frog DIST PRSP look to.MED INC see 3SG DET dog
 'So the frog looked around and he saw the dog.' (JR-20150624)
- b. *Gai **de kailuu laa** ga galo adu [**ia** gu gidee de gaaduu]...
 so DET frog DIST PRSP look to.MED 3SG INC see DET dog
 'So the frog looked around and he saw the dog.' (JR-20221006)

- (65) Strict VSO in nominalized clauses
- a. E duudagi i de [llanga a Ruth denga gede].
 IPFV continue PREP DET weave GEN.A Ruth DET.PL basket
 ‘Ruth continued to weave the baskets.’ (JR-20230906)
- b. *E duudagi i de [Ruth llanga denga gede].
 IPFV continue PREP DET Ruth weave DET.PL basket
 Intended: ‘Ruth continued to weave the baskets.’ (JR-20230427)

These word order patterns are summarized by clause type in Table 4.1.

Word order	Probe possibilities	Clause type
Obligatory SVO	C ₁ -Probe	Declarative clauses Complement clauses
Optional SVO	C ₁ -Probe C ₁ -NoProbe	Adjunct clauses Polar and content questions Relative clauses
No SVO	C ₁ -NoProbe	Nominalized clauses Chained clauses

Table 4.1: Summary of word order patterns

We can model this variation in word order by positing two versions of C₁: one that carries a phi probe, triggering subject movement, and one that has no probe. I will notate these two flavors as C₁-Probe and C₁-NoProbe, respectively. Assuming that clause type is determined by different flavors of C₂, I propose that the connection between subject movement and clause type is carried out via a selectional relationship between C₂ and C₁. Declarative C₂ always selects for probe-bearing C₁; other flavors of C₂, namely the interrogative, relative, and adjunct C₂ heads, can select for C₁ with or without the relevant probe (66).²²

- (66) Selectional properties of C₂
- a. C_{Decl}: Selects for C₁-Probe only
- b. C_{Adj}, C_{Int}, C_{Rel}: Select for C₁-Probe OR C₁-NoProbe

Finally, clauses that lack CP will have obligatory VSO word order, since they lack the projection that triggers subject movement. As I argued in §4.3.1, this is the case for chained clauses, which are IPs. Nominalized clauses cannot be SVO for the same reason: I argue in Chapter 7 that nominalized clauses are FPs, lacking both an IP and CP layer, meaning they are not large enough to host a pre-verbal subject.

²²Alternatively, we could capture the same behavior by proposing that C_{Adj}, C_{Int}, and C_{Rel} optionally select for a truncated clause, which lacks a C₁ head altogether. In the absence of evidence for this truncation, I opt for an implementation with different flavors of C₁ instead, but more research is needed to distinguish between the two possibilities.

In short, subject movement occurs if and only if C_1 carries a phi probe; there appear to be no further considerations that drive subject movement in Nukuoro. Traditionally, movement to subject position is associated with additional motivations, such as an EPP requirement (e.g., Chomsky 1982), which ensures that the specifier of some projection be filled with overt material, or a need for the subject to be (Case-)licensed (e.g., Chomsky 1981). Neither of these assumptions can be made for Nukuoro subject movement: C does not require its specifier to be filled, and subjects are licensed in the absence of C.

For instance, we can observe that Nukuoro C_1 does not require overt material in its specifier by looking at existential constructions and predicates that do not take any arguments. If there were an EPP requirement, we would expect Nukuoro to require an expletive subject if there was no contentful subject available, but this is not the case: existential predicates and zero-place predicates (e.g., weather predicates) do not require material to precede the TAM marker (67). We can tell that these clauses are CP-sized because they are preceded by complementizers in embedded environments (68).

- (67) a. E hanu stoosaa i hongaa Pohnpei.
 IPFV some car PREP top Pohnpei
 ‘There are cars on Pohnpei.’ (ML-20160621)
- b. E haga-vvela.
 IPFV CAUS-hot
 ‘It’s hot (outside).’ (JR-20211014)
- (68) Koisii e maanadu [**boloo** e deai donu stoosaa i Pohnpei].
 Kois IPFV think COMP IPFV no EMPH car PREP Pohnpei
 ‘Kois thinks there are no cars in Pohnpei.’ (JR-20230906)

Additionally, subjects can appear in post-verbal position when CP is absent, suggesting that movement to Spec,CP is not necessary for subject licensing.²³ In chained clauses, which do not contain a CP layer, overt post-verbal subjects are licensed.

- (69) Gai ia ga kave a Vave [_{IP} ga hai bodu **gilaau**].
 then 3SG PRSP take PN Vave PRSP make spouse 3DU
 ‘So she took Vave and they got married.’ (Gininga, 10-1, line 78)

These constructions show that subject movement to Spec,CP is simply triggered by the presence of the probe-bearing flavor of the C_1 head, rather than a more specific requirement of the subject or the C_1 head itself.

4.4 Conclusion

This chapter has established the structure of Nukuoro matrix clauses, which sets the stage for the rest of the dissertation. Nukuoro SVO order is derived via three steps of movement, some of

²³I argue in chapter 7 that Nukuoro is sensitive to Case licensing, but that licensing for subjects is carried out by Infl, not C. Agreement with Infl does not trigger movement, pulling apart subject licensing and subject position.

which are familiar from other Polynesian languages and some which are not. All Nukuoro objects undergo A-movement to an inner specifier of vP , except N^0 objects which have been incorporated; the remnant VP then undergoes fronting to the specifier of FP, a projection just below Infl (and optionally Neg). Finally, in SVO clauses, subjects move from their base position in the (outer) specifier of vP to Spec,CP.

The clause structural mechanisms described in this chapter have a several implications for theories of word order and movement. First, Nukuoro demonstrates that predicate fronting may occur in a language with basic SVO word order, which has also been described in the closely-related language Imere (van Urk 2022). Phrasal verb movement is sometimes framed as an operation which takes place in lieu of subject movement to satisfy the EPP requirement of T (Massam & Smallwood 1997; Alexiadou & Anagnostopoulou 1998; Massam 2000; Pearson 2001; Aldridge 2002); this framing of VP-fronting contrasts with what has been said about verbal head movement, which has been proposed for languages that show a variety of word orders, including SVO (see e.g., Harizanov & Gribanova 2018). The present work on Nukuoro shows that VP-fronting and subject movement are not two sides of the same coin, but rather two independent mechanisms which can occur alongside each other.

Additionally, the analysis that I put forth here breaks down the traditional division of labor between the T/Infl and C domains, where T/Infl is assumed to carry out A-operations and C is assumed to drive \bar{A} -movement (e.g., Rizzi 1997, *et seq.*). I propose an instance of movement to Spec,CP that does not involve any \bar{A} or discourse features.²⁴ While movement to Spec,CP has been argued to show A-properties in a variety of languages, such as Dinka (van Urk 2015), Khanty (Colley & Privoznov 2020), Khalkha Mongolian (Gong 2022) and Tira (Jenks 2023), among others, these A-properties are typically found alongside \bar{A} -properties, such as topical interpretations and non-local movement possibilities. The possibility of true A-movement to Spec,CP in Nukuoro supports a featural view of the A/ \bar{A} distinction (e.g., van Urk 2015) and shows that the C domain is not limited to discourse-sensitive phenomena. This conclusion dovetails nicely with claims that Spec,TP/IP can be associated with \bar{A} features in some languages (e.g., Yiddish, Diesing 1990; English, Mikkelsen 2005), which further divorces the A/ \bar{A} distinction from specific structural positions.

²⁴ Alternatively, one could pursue an analysis that involves a more articulated IP, along the lines of Pollock (1989); on such an analysis, Nukuoro pre-verbal subjects could move to the specifier of a higher IP projection, rather than a lower CP projection. I pursue the articulated CP analysis for consistency with analyses of other Polynesian languages, and to underscore the analysis of genitive subjects that I develop in Chapter 5.

Chapter 5

Genitive relative clauses and pseudoclefts

In this chapter, I provide an analysis of Nukuoro \bar{A} -extraction contexts, namely relative clauses, content questions, and focus constructions, all of which involve relativization. The structure of these contexts provides necessary background for the discussion of Nukuoro syntactic ergativity, which I analyze in the next chapter.

Like many Polynesian languages, Nukuoro uses a genitive relative clause (GRC) strategy, where the subject of the relative clause appears in genitive case. When an object or oblique argument is relativized, the pre-verbal subject of the relative clause is marked genitive, whether the subject is intransitive (1a) or transitive (1b).

- (1) a. de masoaa **oogu** ne seese ai
 DET time 1SG.GEN.O PFV walk
 ‘the time that I walked’ (JR-20190620)
- b. de hine **a togidaa** ne haga-ola laa
 DET woman GEN.A DET.doctor PFV CAUS-be.safe DIST
 ‘the woman that the doctor saved’ (JR-20211214)

The GRC construction is well-documented in Polynesian languages (Herd et al. 2011), including Niuean (Seiter 1980), Tongan (Otsuka 2010b), Maori (Bauer 1997), and Hawaiian (Hawkins 2000; Baker 2006, 2012). There is also a large body of work which analyzes GRCs outside of Polynesian, such as in Japanese (Miyagawa 2008, 2011), Turkish (Aygen 2007; Kornfilt 2008), Dagur (Hale 2002), and a number of other typologically-diverse languages (Krause 2001).

Genitive relative subjects show an interesting combination of properties: they receive genitive case, indicating a relationship with the higher nominal domain, yet they are interpreted thematically as arguments of the embedded clause. For this reason, analyses of GRCs vary as to whether the genitive subject remains within the relative clause (e.g., Hale 2002; Kornfilt 2008; Miyagawa 2008, 2011) or occupies a position outside of the relative clause, where it is related via movement or control to an element in embedded subject position (Otsuka 2010b; Herd et al. 2011). I will refer to these as *internal genitive* and *external genitive* analyses, respectively.

Polynesian GRCs are typically analyzed as having external genitive subjects, largely due to the fact that genitives appear in a position that is typically not available for subjects. Niuean, for

instance, has obligatorily post-verbal subjects; subjects may only occupy a pre-verbal position if they are discourse-differentiated (e.g., focused, topicalized) and preceded by the particle *ko* (Seiter 1980). Genitive subjects of relative clauses, on the other hand, appear pre-verbally without *ko* (2). Since subjects are typically not permitted in this position, it is inferred that genitive subjects are not within the relative clause.

- (2) Niuean relative clauses (Seiter 1980:97)
- a. e mena [ne tunu ai e koe e moa]
 ABS thing NFUT cook OBL ERG 2SG ABS chicken
 ‘the thing you cooked the chicken in’
- b. e mena haau [ne tunu ai e moa]
 ABS thing 2SG.GEN NFUT cook OBL ABS chicken
 ‘the thing you cooked the chicken in’

Crucially, though, Nukuoro differs from other Polynesian languages in having unmarked SVO word order, as established in Chapter 4. Subjects of matrix clauses typically precede the verb (3a), meaning that the pre-verbal position of genitive subjects is not as unusual in Nukuoro as it is in verb-initial languages. What is more striking in Nukuoro is that pre-verbal subjects of relative clauses are obligatorily genitive (3b): unmarked pre-verbal subjects, which are preferred in matrix clauses, are unavailable in relative clauses (3c).

- (3) a. **Ia** e daadaa dahi hoe.
 3SG IPFV carve.RED one paddle
 ‘S/he is carving a paddle.’ (JR-20230504)
- b. de masovaa **aana** ne daadaa ai dahi hoe
 DET time 3SG.GEN.A PFV carve.RED OBL one paddle
 ‘the time that s/he carved a paddle’ (JR-20230504)
- c. *de masovaa **ia** ne daadaa ai dahi hoe
 DET time 3SG PFV carve.RED OBL one paddle
 Intended: ‘the time that s/he carved a paddle’ (JR-20230504)

For Nukuoro GRCs, I propose that the genitive subject is internal to the relative clause, building on insights from Baker (2006, 2012) regarding Hawaiian GRCs and following much of the literature on GRCs outside of Polynesian. I propose that pre-verbal subjects of relative clauses occupy the same position as pre-verbal matrix subjects, namely the specifier of a lower CP₁ projection (as established in Chapter 4). In this position in the left periphery, I argue that pre-verbal subjects are outside of the CP phase; in relative clauses, pre-verbal subjects are thus accessible for genitive case assignment from the higher nominal domain. Note that the relative head is not eligible for Case assignment, which I discuss further in §5.1.3. The proposed structure for an object GRC is provided in (4), which assumes that the relative head moves from its base-generated position within the relative clause to its surface position (i.e., a raising analysis of relativization; Kayne 1994; Bianchi 1999).¹

¹For the purposes of this analysis and the rest of the dissertation, any analysis of relative clause formation will

(4) Object relative clause structure in Nukuoro

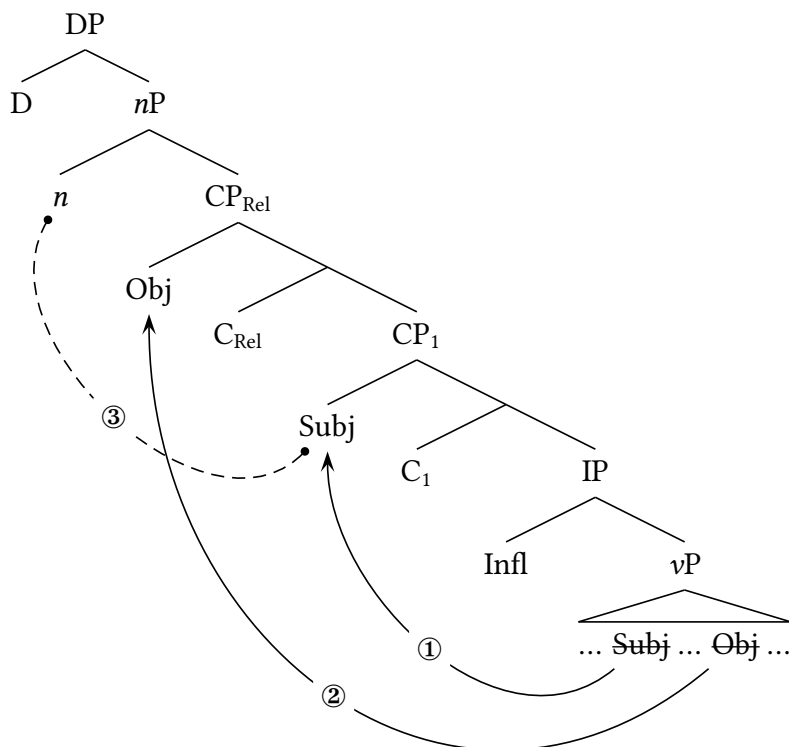

The primary takeaway from the structure in (4) is that relative clauses are structured similarly to matrix clauses: subjects undergo movement to Spec,CP₁. Relativization is not impeded in any way by the genitive subject, which is a canonical, clause-internal subject. This understanding provides a useful backdrop for the rest of the dissertation, which analyzes extraction restrictions in relative clauses. Relativization is found across all \bar{A} -movement constructions in Nukuoro, namely relative clauses themselves as well as *wh*-questions and focus constructions, which use a pseudocleft structure.

This chapter proceeds as follows. Section 5.1 introduces and analyzes Nukuoro genitive relative clauses. Specifically, I argue that genitive subjects of relative clauses are internal to the relative clause and occupy the same position as unmarked pre-verbal subjects, namely Spec,CP₁. Section 5.2 turns to the pseudocleft structure of focus and *wh*-questions, which consists of a predicate focus/*wh* element followed by a (headless) relative clause.

suffice. I adopt a raising analysis here for concreteness; however, my claims about the position of genitive subject are also compatible with a head-external analysis (Partee 1975; Chomsky 1977a) or a matching analysis (Chomsky 1965; Sauerland 1998, 2000, 2003). It is also possible (and perhaps likely) that Nukuoro utilizes multiple relativization strategies, as has been argued for a number of unrelated languages (e.g., Bhatt 2002; Hulsey & Sauerland 2006).

5.1 Genitive relative clauses

Nukuoro uses two strategies for relativization: an unmarked strategy and a genitive relative clause (GRC) strategy. Unmarked relative clauses have verb-initial word order, as shown in (5). GRCs, which are used for object and oblique relatives, have pre-verbal subjects which are marked with genitive case (5b). Neither strategy uses a relative pronoun or complementizer.²

- (5) a. de masovaa [ne kada ai **gilaadeu**]
 DET time PFV laugh OBL 3PL
 ‘the time that they laughed’ (JR-20190620)
- b. de masovaa [**olaadeu** ne kada ai]
 DET time 3PL.GEN.O PFV laugh OBL
 ‘the time that they laughed’ (JR-20190620)

In this section, I provide a description and structural analysis of the Nukuoro GRC, arguing that genitive subjects are internal to the relative clause. I propose that genitive subjects of relative clauses occupy the same position as matrix subjects, namely Spec,CP; in this position, they are accessible for genitive case assignment from the higher nominal domain.

5.1.1 GRC basics

Genitive marking in GRCs targets subjects, a pattern which can be observed in object relative clauses (6) as well as oblique relative clauses (7). The oblique relative clauses demonstrate that genitive marking appears on both intransitive and transitive subjects.

- (6) a. de gahudi [**aana** ne gidee]
 DET banana 3SG.GEN.A PFV see
 ‘the banana that he saw’ (JR-20190620)
- b. taagoli [**a de hine** ne daadaa laa]
 DET.taro GEN.A DET woman PFV peel DIST
 ‘the taro that the woman peeled’ (JR-20230504)
- (7) a. de masovaa [**o de gauligi** ne seese ai]
 DET time GEN.O DET child PFV walk OBL
 ‘the time that the child walked’ (JR-20190620)
- b. de masovaa [**aa**u ne saabai ai de gede]
 DET time 2SG.GEN.A PFV carry OBL DET basket
 ‘the time that you carried the basket’ (JR-20190620)

The GRC strategy is only used for object and oblique relatives (i.e., relatives that do not involve \bar{A} -movement of the subject). When the subject itself is relativized, no argument appears in genitive case (8a). Genitive marking cannot appear on the relativized subject (8b).

²Since the examples in (5) are oblique relative clauses, they require the oblique pronoun *ai* to appear immediately following the verb. Section 3.2.9 of Chapter 3 describes oblique relativization in more detail, and §6.3.2 of Chapter 6 provides an analysis of *ai* as a resumptive pronoun.

- (8) a. de **hine** [ne seese laa gi de hale goloa]
 DET woman PFV walk DIST to DET house goods
 ‘the woman who walked to the store’ (JR-20230427)
- b. *de a **de hine** [ne seese laa gi de hale goloa]
 DET GEN.A DET woman PFV walk DIST to DET house goods
 Intended: ‘the woman who walked to the store’ (JR-20230504)

The availability of genitive marking on relative subjects corresponds to the position of the subject: pre-verbal subjects must be genitive, while post-verbal subjects must be unmarked. As mentioned above, genitive marking is obligatory on pre-verbal subjects, as show in (9); this is surprising given that unmarked pre-verbal subjects are permitted in matrix clauses (cf. (3a)).

- (9) a. de masovaa [**olaadeu** ne kada ai]
 DET time 3PL.GEN.O PFV laugh OBL
 ‘the time that they laughed’ (JR-20190620)
- b. *de masovaa [**gilaadeu** ne kada ai]
 DET time 3PL PFV laugh OBL
 Intended: ‘the time that they laughed’ (JR-20230504)

The opposite is true of post-verbal subjects. When subjects appear post-verbally in relative clauses, they must be unmarked; genitive post-verbal subjects are not permitted (10).

- (10) a. de masovaa [ne kada ai **gilaadeu**]
 DET time PFV laugh OBL 3PL
 ‘the time that they laughed’ (JR-20190620)
- b. *de masovaa [ne kada ai **olaadeu**]
 DET time PFV laugh OBL 3PL.GEN.O
 Intended: ‘the time that they laughed’ (JR-20230504)

Finally, it is impossible to get genitive marking on arguments other than the subject: for instance, objects may not receive genitive marking, whether they appear in canonical object position (11a) or at the left edge of the relative clause (11b-c).³

- (11) a. *de masovaa [(a) Soni ne saabai ai **aagu**]
 DET time GEN.A Johnny PFV carry OBL 1SG.GEN.A
 Intended: ‘the time that Johnny carried me’ (JR-20220706)
- b. *de masovaa [**aagu** Soni ne saabai ai]
 DET time 1SG.GEN.A Johnny PFV carry OBL
 Intended: ‘the time that Johnny carried me’ (JR-20220706)
- c. *de masovaa [**aagu** ne saabai ai Soni]
 DET time 1SG.GEN.A PFV carry OBL Johnny
 Intended: ‘the time that Johnny carried me’ (JR-20220706)

³Note that the relative clause in (11c) is grammatical with the meaning ‘the time that I carried Johnny’.

The same is true of subject relativization contexts: even when objects are the only nominal remaining within the relative clause, they cannot receive genitive marking, regardless of their position (12). This data shows that genitive marking does not simply target the highest nominal remaining in the relative clause: it specifically targets subjects.

- (12) a. * de hine [ne llaanga ina **a/o denga gede**]
 DET woman PFV weave.CIA INA GEN DET.PL basket
 Intended: ‘the woman who wove the baskets’ (JR-20230504)
- b. * de hine [**a/o denga gede** ne llaanga ina]
 DET woman GEN DET.PL basket PFV weave.CIA INA
 Intended: ‘the woman who wove the baskets’ (JR-20230504)

The available positions and case marking of relative clause subjects and objects are summarized in Table 5.1.

	Pre-verbal	Post-verbal
Subject	Genitive	Unmarked
Object	*	Unmarked

Table 5.1: Case marking of arguments in relative clauses

The genitive marking found in relative clauses shares key properties with genitive marking found on canonical possessors. First, all genitives regardless of function fall into one of two morphological classes: in possession environments, *a*-class genitives are used for alienable possession, while *o*-class genitives are used for inalienable possession. This distinction is marked by a vowel alternation in the form of the genitive particle or pronoun. The same morphological alternation is found on genitive subjects of relative clauses, where *a*-class genitives are used for transitive/agentive subjects and *o*-class genitives are used for all other subjects.⁴

The two genitive environments also show parallel behavior in the position of the genitive argument. In canonical possession, there are two positions available for genitives: a post-nominal position, which is available to all genitive arguments, and a pre-nominal position, which is only available for pronouns. Full nominal and proper name possessors must follow the possessed noun, where they are introduced by a genitive particle *a/o* (13). Pronominal possessors, by contrast, typically appear between the determiner and the possessed noun (14).⁵

⁴The distinction between *a*- and *o*-class genitives has been attributed to agentivity of the genitive subject in Hawaiian (Baker 2012) as well as Nukuoro (Drummond 2016). In Nukuoro texts (Carroll 1980), however, the alternation appears to reflect ergativity, with *a*-class marking for ergative subjects and *o*-class marking for absolutive subjects. Modern speakers do not have consistent judgements on this alternation; for this reason, I do not account for this pattern here, though it may be a remnant of morphological ergativity in the language (cf. Chapter 7).

⁵In Nukuoro, it is possible, though marked, to use a post-nominal genitive when the possessor is a pronoun; interestingly, postposed genitive pronouns are perfectly natural in Nukuoro GRCs.

- (13) a. *de hale o Soni*
 DET house GEN.O Soni
 ‘Johnny’s house’ (JR-20230414)
- b. *de gaaduu a de hine laa*
 DET dog GEN.A DET woman DIST
 ‘that woman’s dog’ (JR-20230504)
- (14) a. *dahi olaau hale*
 one 3DU.GEN.O house
 ‘one of their (DU) houses’ (JR-20230414)
- b. *hanu agu vai*
 some 1SG.GEN.A water
 ‘some of my water’ (JR-20190705)

With certain determiners, namely definite singular *de* and indefinite singular *se*, pronominal possessors that appear before the possessed noun are morphologically fused with the preceding determiner (15).

- (15) a. *d-ogu stoosaa*
 DET-1SG.GEN.O car
 ‘my car’ (JR-20190628)
- b. *de-laadeu gaaduu*
 DET-3PL.GEN gai
 ‘their (PL) food’ (JR-20230504)

The same two positions are available for genitive subjects of relative clauses: genitive subject pronouns may appear after the relative head (16a) or before the relative head (16b), where they may morphologically fuse with the determiner of the relative head (16c).⁶

- (16) a. *taane [aagu ne gidee laa]*
 DET.man 1SG.GEN.A PFV see DIST
 ‘the man that I saw’ (JR-20190620)
- b. *luu agu daane [ne doolohi]*
 DET.DU 1SG.GEN.A man PFV chase
 ‘the two men that I chased’ (JR-20211214)
- c. *d-agu daane [ne gidee laa]*
 DET-1SG.GEN.A man PFV see DIST
 ‘the man that I saw’ (JR-20190620)

The pre-nominal position for genitive subject pronouns indicates some amount of shared syntactic structure between these two contexts. Furthermore, genitive subjects which appear before

⁶The difference in vowel length between (16a) and (16b) seems to indicate post-posed genitive pronouns have an additional genitive particle *a/o* before the genitive pronoun itself, which begins with a mutating vowel *a/o*.

the relative head are discontinuous with the rest of the relative clause (16b-c), a fact which needs to be captured on any analysis of the Nukuoro GRC.

To summarize, genitive marking only appears on pre-verbal subjects of relative clauses: objects and post-verbal subjects can never receive genitive marking. Furthermore, genitive subjects of relative clauses show the same syntactic behavior as genitive-marked possessors: pronominal genitive subjects can undergo preposing to a position adjacent to the determiner.

5.1.2 Genitive subjects are RC-internal

Analyses of GRCs seek to explain the position of the genitive-marked subject and the nature of its relationship with both the relative clause and the nominal domain. Existing analyses can be grouped into two broad classes: those which assume the genitive-marked subject is outside of the relative clause, and those which assume the genitive-marked subject is inside the relative clause. I refer to these as *external* and *internal* genitive analyses, respectively. Within the class of clause-external analyses, there are two analytic options: the genitive subject could be a true possessor, forming a constituent with the relative head, or the genitive subject could appear just above the relative clause, forming a constituent with the relative clause. These three possibilities are summarized in (17), with the relative head underlined and the genitive subject bolded, using the example GRC repeated here from (5b).

- (5b) de masovaa **olaadeu** ne kada ai
 DET time 3PL.GEN.O PFV laugh OBL
 ‘the time that they laughed’ (JR-20190620)
- (17) a. External genitive analyses
- i. *Genitive is a possessor* (= Seiter 1980)
 the [_{NP} time **they.GEN**] [_{RC} laughed]
 - ii. *Genitive forms a constituent with the RC* (= Herd et al. 2011)
 the time [**they.GEN** [_{RC} laughed]]
- b. Internal genitive analyses
- i. *Genitive is at the left edge of the RC* (= Baker 2006)
 the time [_{RC} **they.GEN** laughed]

On external genitive analyses, the genitive is construed with a null element in subject position of the relative clause either by movement (Clark 1976) or control (Otsuka 2010b; Herd et al. 2011).⁷

In Nukuoro, I will argue against the two external analyses in favor of the internal genitive analysis: genitive subjects occupy a position at the left edge of the relative clause. In fact, I propose that genitive subjects occupy the same position as pre-verbal matrix subjects, namely the specifier of CP, where they are assigned genitive case from a higher nominalizing *n*⁰.

⁷On the movement theory of control (e.g., Hornstein 2000; Boeckx & Hornstein 2004), these two alternatives would reduce to the same mechanism.

First, let us evaluate the possessor hypothesis (17ai). While genitive subjects share some syntactic properties with possessors, such as alienability marking and preposing, they do not have the syntactic distribution expected of possessors, a fact which has been noted by previous authors (Hawkins 2000; Baker 2006, 2012; Herd et al. 2011). Canonical possession structures disallow two genitive-marked nominals, as shown in (18a). This restriction fails to hold if one of the nominals is a genitive subject: the same string is grammatical in (18b), where one genitive nominal is the possessor of the relative head and the other is a genitive subject.

- (18) a. *Au gu kave de beebaa o **Jeschke a Emily**.
 1SG INC take DET book GEN.O Jeschke GEN.A Emily
 Intended: ‘I borrowed Emily’s book about Jeschke.’ (JR-20221215)
- b. Au gu kave de beebaa [o **Jeschke a Emily** ne dau laa].
 1SG INC take DET book GEN.O Jeschke GEN.A Emily PFV read DIST
 ‘I borrowed the book about Jeschke that Emily read.’ (JR-20221215)

The same behavior holds when one genitive would be preposed and the other would be postposed: possession structures do not permit two genitive nominals, while the same string is permitted if one of the genitive arguments is a genitive subject (19).

- (19) a. * [**D-ogu** ada a **Mary**] e molomolo.
 DET-1SG.GEN.O picture GEN.A Mary IPFV clear
 Intended: ‘Mary’s picture of me / My picture of Mary is clear.’ (JR-20221215)
- b. [**D-ogu** ada a **Mary** ne kave laa] e molomolo.
 DET-1SG.GEN.O picture GEN.A Mary PFV take DIST IPFV clear
 ‘The picture of me that Mary took was clear.’ (JR-20221215)

In this way, genitive subjects of relative clauses do not show all of the same behaviors as typical possessors, which speaks against an external genitive analysis in which the genitive subject is a nominal possessor (17ai).

Even though genitive subjects do not occupy the same position as possessors of the relative head, it is still possible that genitive subjects occupy a position outside of the relative clause (17a_{ii}), as argued by Herd et al. (2011). On their analysis, the genitive is introduced in a PossP projection above the relative clause, where it controls a null element in subject position. The relative head then (optionally) moves above PossP, deriving the postposed genitive word order.

(20) GRC analysis for (5b), following the proposal by Herd et al. (2011:1256, 1258)

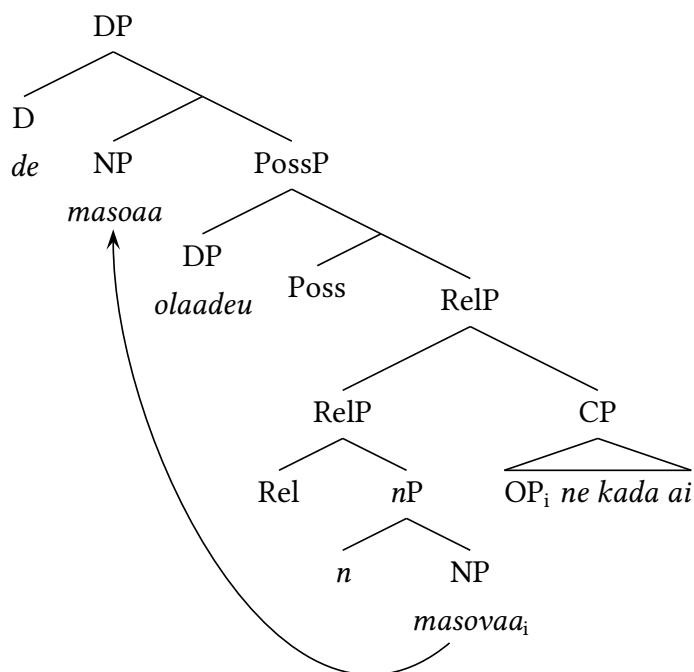

Unlike Herd et al. (2011), however, I argue that Nukuoro genitive subjects are within the relative clause, based on two diagnostics. First, I show that genitive subjects can appear lower than relative clause adverbs; second, I show that genitive subjects appear within relative clause coordinations. Assuming that these two diagnostics sufficiently delimit the relative clause boundary, these two facts suggest that genitive subjects occupy a position within the relative clause.

The first piece of evidence that genitive subjects are within the relative clause comes from adverb placement. Temporal adverbs like *anaahi* ‘yesterday’ typically appear clause-initially or clause-finally. Clause-initial temporal adverbs may precede the genitive subject in relative clauses, intervening between the genitive subject and the higher relative head (21a). The grammaticality of this word order persists when the adverb is forced to belong to the relative clause—for instance, if a conflicting temporal adverb is present in the matrix clause (21b).

- (21) a. Au ne basa ange gi de hine [**anaahi** a togidaa ne hagaola laa].
 1SG PFV talk DIR.DIST to DET woman yesterday GEN.A DET.doctor PFV save DEM
 ‘I talked to the woman that the doctor saved yesterday.’ (JR-20211214)
- b. Anailaanei au ne dau de beebaa [**anaahi** aaau ne dau laa ga odi].
 today.PST 1SG PFV read DET book yesterday 2SG.GEN.A PFV read DEM PRSP finish
 ‘Today I read the book that you finished yesterday.’⁸ (JR-20211214)

⁸The speaker readily accepted this sentence as grammatical; however, when he repeated the sentence back, he placed *anaahi* at the end of the relative clause.

The fact that genitive subjects may appear to the right of clause-internal modifiers suggests that genitive subjects remain clause-internal as well.

Additionally, we can observe that genitive subjects can appear within relative clause coordinations, suggesting that they remain within the relative clause. Relative clauses can be coordinated using the clausal coordinator *gai*: a single relative head can be modified by conjoined relative clauses. These coordinations can have genitive-marked subjects (22), suggesting that genitive subjects are contained within the relative clause itself.

- (22) Ruth ne dau de beebaa [oogu e vaasuu ai] gai [oou e kino ai].
 Ruth PFV read DET book 1SG.GEN.O IPFV like OBL and 2SG.GEN.O IPFV hate OBL
 ‘Ruth read the book that I like and you hate.’ (JR-20211214)

An alternative analysis of (22) is that the two conjuncts are larger than a clause: the two conjuncts could be nominals modified by relative clauses, with a null relative head in the second conjunct. On this analysis, the genitive subject contained within the coordination could still be outside of the relative clause, as shown in (23).

- (23) Ruth ne dau [_{DP} de beebaa oogu [_{RC} e vaasuu ai]] gai [_{DP} Ø oou [_{RC} e kino ai]].

However, if these were coordinated nominals, we would expect a different coordinator to appear, namely the nominal coordinator *ma*; we might also expect that the second null relative head could have a different referent than the first, implying that Ruth read two different books. Neither of these expectations is borne out: the two relative clauses cannot be coordinated with *ma* (24), and they cannot describe different referent(s) (25).

- (24) * Ruth ne dau de beebaa [oogu e vaasuu ai] **ma** [oou e kino ai].
 Ruth PFV read DET book 1SG.GEN.O IPFV like OBL and 2SG.GEN.O IPFV hate OBL
 Intended: ‘Ruth read the book that I like and you hate.’ (JR-20230302)
 JR: ‘The word *ma* makes the sentence awful.’

- (25) [Context: Ruth read *Persuasion* and *Emma*. I love *Persuasion*, and you hate *Emma*.]
 # Ruth ne dau de beebaa [oogu e vaasuu ai] gai [oou e kino ai laa].
 Ruth PFV read DET book 1SG.GEN.O IPFV like OBL and 2SG.GEN.O IPFV hate OBL DIST
 Intended: ‘Ruth read the book that I like and (the book) you hate.’ (JR-20230302)
 JR: ‘No, this means the book Ruth read, you like it and I hate it.’

5.1.3 An analysis of the Nukuoro GRC

In light of these facts, I propose that genitive subjects of relative clauses occupy a position inside the relative clause. Specifically, genitive subjects occupy the same position as matrix subjects, namely the specifier of CP₁. Assignment of genitive case to the subject arises due to the unusually high position for derived subjects: since subjects occupy Spec,CP, they are not contained within the CP spell-out domain, and are thus accessible for A-dependencies with higher structure.

I propose that relative clauses involve a different flavor of C_2 , namely C_{Rel} , which is responsible for carrying out \bar{A} -movement.⁹ The lower CP_1 layer carries out subject movement as normal. The entire CP_{Rel} is then nominalized by higher functional structure, including n^0 , which assigns genitive case to the pre-verbal subject, and D^0 , which hosts determiners. The proposed structure for an object GRC is provided in (26).

(26) Object GRC structure

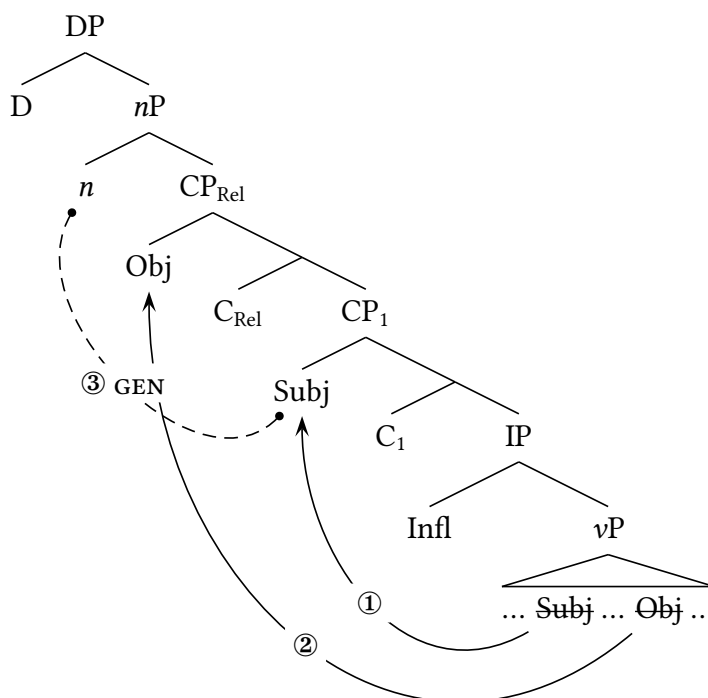

When the subject itself is the target of relativization, the \bar{A} -probe on C_{Rel} simply encounters and moves the pre-verbal subject in Spec,CP₁, as shown in (27).

(27) Subject relative clause structure

⁹I provide a more detailed specification for the \bar{A} -probe on C_{Rel} in Chapter 6, where I account for the Nukuoro ergative extraction restriction.

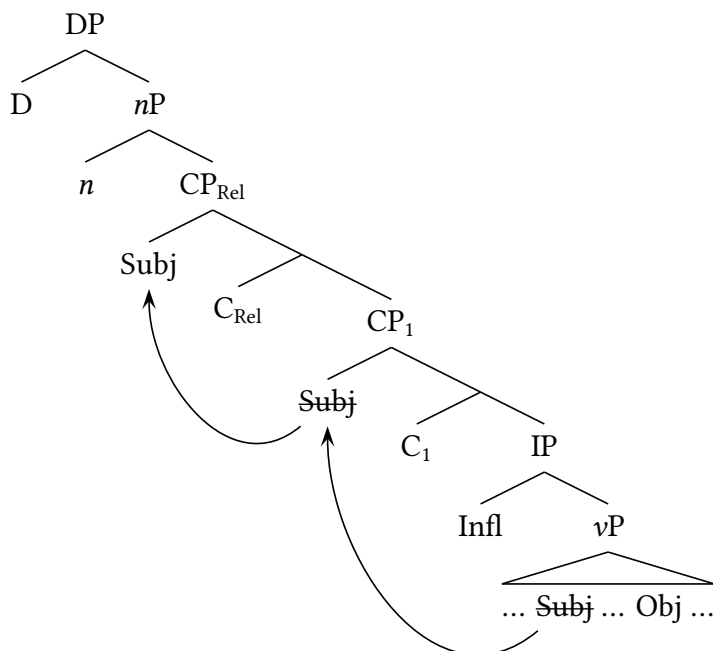

The key claims of this section concern the mechanism of genitive case assignment and the position of the subject DP. I propose that n^0 is responsible for assigning genitive case to the most local DP in its c-command domain. In canonical possession environments, this results in genitive assignment to the DP possessor (28). If the DP possessor is a pronoun, agreement with n^0 may also trigger movement to Spec, nP ;¹⁰ in this position, the pronominal possessor is syntactically adjacent to the determiner and may undergo morphological merger (29).

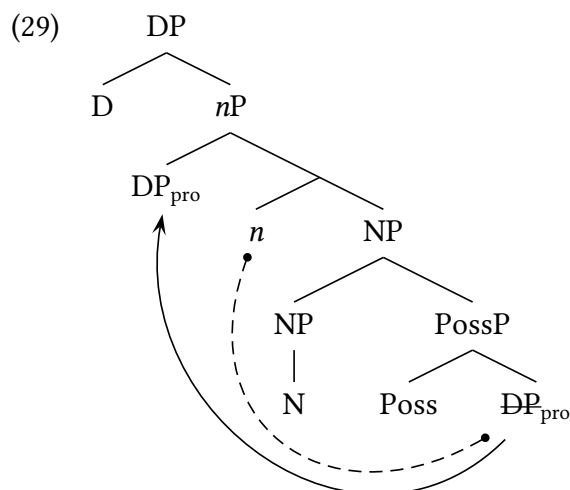
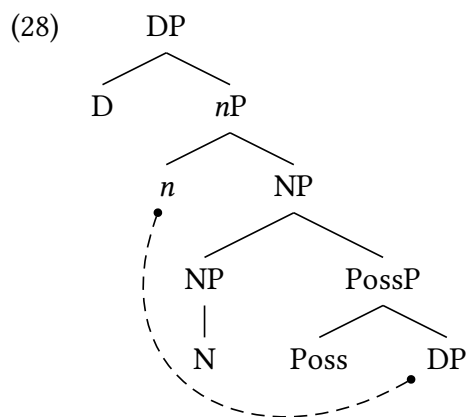

¹⁰In other words, n^0 assigns genitive to DPs of all kinds, but only moves pronominal DPs. We can model this movement pattern in an Interaction-Satisfaction framework (Deal 2015b, 2022) by stating that the probe on n^0 interacts with [D]—resulting in feature copying and Case assignment—but is satisfied by a feature specific to pronouns, such as [Index] (Jenks & Konate 2022). This satisfaction condition optionally carries an instruction to trigger movement, resulting in optional movement of genitive pronouns.

In relative clauses, I propose that pre-verbal subjects are positioned locally enough to receive genitive Case from n^0 , because they are in the left periphery and thus outside of the CP phase. In traditional phase theory (Chomsky 2000, 2001), certain projections like C demarcate domains which are impenetrable for further operations; only material in the specifier of these projections can be accessed by higher operations, constituting an “escape hatch” from the phase. One way to model escape hatch effects is to connect phasehood with phonological spell-out (e.g., Fox & Pesetsky 2004): upon completion of a phasal projection like CP, the C head spells out its complement, rendering all material below C^0 inaccessible for further movement. Only material in the specifier of CP may continue to move, since it is not contained within C’s spell-out domain.

In Nukuoro, I suggest that CP spell-out is delayed, allowing both pre-verbal subjects and \bar{A} -elements to escape the CP phase. Specifically, I propose that it is the complement of the lower C_1 head (namely, IP) that is spelled out, but that spell-out is only triggered once the *higher* CP_2 projection is completed.¹¹ This phase mechanism ensures that the probe on n^0 can access a subject in Spec, CP_1 —even after CP_2 has been created—but it cannot probe into the complement of C_1 . Delayed spell-out derives the correct genitive-marking pattern in GRCs: pre-verbal subjects receive genitive Case from n^0 , while all other arguments, including post-verbal subjects and objects, cannot receive genitive Case because they are contained within the CP phase (30).

(30) Genitive assignment to pre-verbal subjects

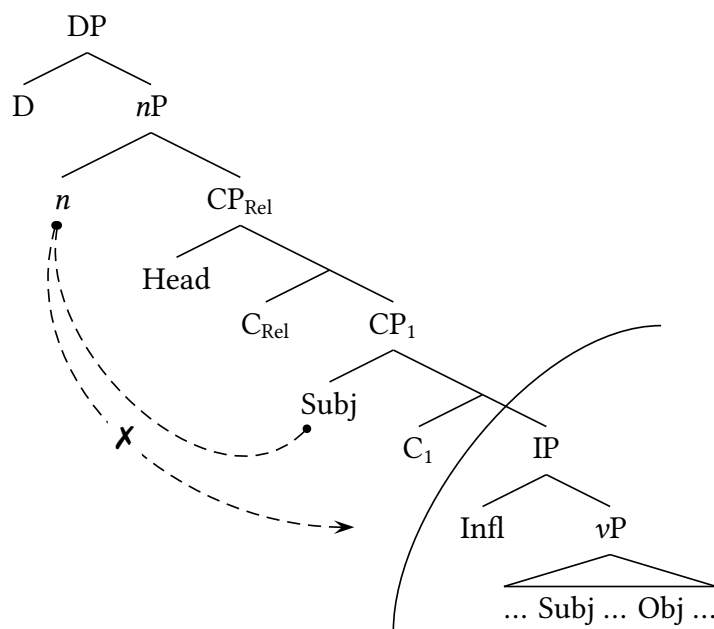

¹¹This proposal shares similarities with Deal’s (2017a) “delayed opacity” approach to hyperraising, where the CP phase is only rendered opaque upon Merge of the next higher phase head, namely v (Chomsky 2001; Grohmann 2009; Embick 2010). The present account differs from previous approaches in that the CP phase is only rendered opaque once all extended projections of the *same* phasal head have been completed.

In this way, the alternation between pre-verbal genitive subjects and post-verbal unmarked subjects in relative clauses can be attributed to optional subject movement. As described in Chapter 4, movement to pre-verbal position is obligatory in Nukuoro matrix clauses, but optional in other clause types, including questions, adjunct clauses, and relative clauses (§4.3.3). When the subject moves to Spec,CP₁, it obligatorily receives genitive case from n^0 ; if it remains in its base position in Spec,vP, it is inaccessible for genitive assignment and appears unmarked.

Two notes are in order regarding genitive case assignment to the pre-verbal subject. First, as with canonical possession, the agreement relationship between n and the subject may trigger movement to Spec,nP if the subject is a pronoun; this optional movement generates preposed orders like those in (16), where the pronominal genitive subject appears before the relative head. Second, it is important to note that the relative head itself cannot receive genitive case, despite being the most local nominal to n^0 . This behavior is unsurprising, given that \bar{A} -moved elements are generally opaque to Case assignment cross-linguistically (e.g., Chomsky 1981; Safir 2019). One way to model this behavior would be to claim that \bar{A} -elements are (or become) encased in some kind of functional “shell”, such as QP (Cable 2010) or PP (Safir 2019), which prevents them from being accessible goals for Case assignment. However this opacity is implemented, it prevents relative heads from being licit targets for Agree with n^0 .

Effectively, the phase mechanism described above creates two escape hatches from the CP phase: one from the lower Spec,CP (Spec,CP₁) and one from the higher Spec,CP (e.g., Spec,CP_{Rel}, Spec,CP₂).¹² As a result, we predict that both the relative head and the pre-verbal subject may enter into dependencies with higher structure. This prediction is borne out in finite complement clauses, where both \bar{A} -elements and pre-verbal subjects may undergo further movement into a matrix clause. For instance, Nukuoro allows successive cyclic \bar{A} -movement through finite clauses, confirming that \bar{A} -elements can escape the CP phase (31). This successive cyclicity is demonstrated below for both subjects (31a) and objects (31b).

- (31) a. Go ai_i aana ne maanadu laa [_{t_i} bolo t_i ne buuludi ina ange
 COP.FOC who 3SG.GEN.A PFV think DIST COMP PFV hug INA DIR.DIST
 Soni]?
 Johnny
 ‘Who does s/he think hugged Johnny?’ (JR-20190604)
- b. Go ai_i aana ne maanadu laa [_{t_i} bolo Mina ne buuludi ange t_i]?
 COP.FOC who 3SG.GEN.A PFV think DIST COMP Mina PFV hug DIR.DIST
 ‘Who does s/he think that Mina hugged?’ (JR-20190604)

¹²Another way to model the same behavior would be to claim that relativization and pre-verbal subject movement are carried out by two probes on the same head, along the lines of Jarvis (2022). This analysis would skirt the issue of phasehood, as both the A and \bar{A} elements would move to the specifier of a single CP, but it introduces other stipulations, particularly with regard to the double CP structure I lay out in Chapter 4. Assuming that the trigger for subject movement is always on the same head (namely C₁), \bar{A} -movement would need to be carried out by C₁ as well, effectively doubling the number of flavors of C₁. We would also need to assume that C₂ is not present in relative clauses, to avoid reintroducing the same phase-related challenges I address here.

More strikingly, however, pre-verbal subjects may *also* undergo movement out of a finite clause, supporting the idea that pre-verbal subjects may escape the CP phase.¹³ Nukuoro allows subjects to raise out of finite complement clauses (hyperraising to subject; e.g., Ura 1994; Halpert 2019), which use a complementizer *be* and fully finite inflectional marking; these subjects may optionally raise to subject position of a matrix predicate *dagodo* ‘seem’ or *duulagi* ‘appear’ (32).

- (32) a. E dagodo [be **Soni** e haga-duu dahi hale].
 IPFV seem COMP Johnny IPFV CAUS-stand one house
 ‘It seems like Johnny is building a house.’ (JR-20200617)
- b. **Soni**_i e dagodo [be *t*_i e haga-duu dahi hale].
 Johnny IPFV seem COMP IPFV CAUS-stand one house
 ‘It seems like Johnny is building a house.’ (JR-20200617)

Evidence that this construction involves A-movement, rather than base-generation and binding (i.e., prolepsis; Salzmann 2017a), comes from its locality profile and the persistence of idiomatic interpretations. First, only subjects of the embedded clause may appear in matrix subject position: objects of the embedded clause cannot be pronounced in the higher clause (33). If the matrix subject were controlling a syntactically independent pronoun in the embedded clause, we would expect that this construction would be available to any argument.

- (33) * **Dahi hale**_i e dagodo [be Soni e haga-duu *t*_i].
 one house IPFV seem COMP Johnny IPFV CAUS-stand
 Intended: ‘It seems like Johnny is building a house.’ (JR-20230414)

Secondly, idiomatic interpretations are retained when part of the idiom appears in the higher clause. Nukuoro has a subject idiom *vava de ngudu* (lit. ‘one’s mouth leaks’) which has the idiomatic reading ‘to be chatty’; this idiomatic reading is available whether the subject appears in the embedded clause (34a) or in the matrix clause (34b). Assuming that idioms must be base-generated as a unit to have non-compositional meanings (e.g., Chomsky 1993), the idiomatic reading in (34b) suggests that the matrix subject is base-generated in the embedded clause and moves to its surface position in the matrix clause.

- (34) a. E dagodo [be **de ngudu o Ruth** e vava].
 IPFV seem COMP DET mouth GEN.O Ruth IPFV leak
 Idiomatic: ‘It seems like Ruth is chatty.’
 Literal: ‘It seems like Ruth’s mouth is leaking.’ (JR-20230906)
- b. **De ngudu o Ruth**_i e dagodo [be *t*_i e vava].
 DET mouth GEN.O Ruth IPFV seem COMP IPFV leak
 Idiomatic: ‘It seems like Ruth is chatty.’
 Literal: ‘It seems like Ruth’s mouth is leaking.’ (JR-20230906)

¹³In fact, we’ve already seen an instance of subject movement out of a finite clause: genitive subject pronouns may undergo optional movement to Spec,*nP*, appearing before the relative head (16). These subjects cannot move any higher (i.e., into the matrix clause) because they are contained within the DP phase.

I attribute the existence of hyperraising in Nukuoro to the high position of the pre-verbal subject, along the lines of various other “high subject” approaches to hyperraising (Zyman 2017, 2018; Fong 2019). In its derived position in Spec,CP₁, the subject is outside of the CP phase and thus eligible for further A-movement, in the same way that pre-verbal subjects of relative clauses are eligible for genitive Case assignment.¹⁴

To summarize, genitive marking on subjects of relative clauses can be reduced to an independent property of Nukuoro clause structure, namely movement of subjects to Spec,CP₁. In this position, the subject is outside of the CP phase and thus accessible for genitive case assignment from *n*⁰, an accessibility which is corroborated by the existence of hyperraising in the language.

5.2 The structure of *wh*- and focus constructions

With the structure of relative clauses established, we can now turn to *wh*-questions and focus constructions. These structures in Nukuoro share key properties with relative clauses: when not relativized, *wh*, or in focus, the subject of both constructions appears in genitive case, and the *wh*/focus element is typically introduced by the particle *go* (35).

- (35) a. Go ai aau ne gidee?
 COP.FOC who 2SG.GEN.A PFV see
 ‘Who did you see?’ (JR-20190704)
- b. Go taane laa aagu ne gidee.
 COP.FOC DET.man DIST 1SG.GEN.A PFV see
 ‘THAT MAN is who I saw.’ (JR-20190621)

In this section, I argue that *wh*-questions and focus constructions use a pseudocleft structure, where the *wh* or focused item is a predicate which takes a (headless) relative clause as its subject. This construction is biclausal, involving both a matrix predicate and a subordinated relative clause predicate; this derivation contrasts with canonical structures for *wh*/focus movement, which involve movement of the \bar{A} -element to the left periphery of a single clause. Pseudocleft *wh*/focus constructions have been proposed throughout the Austronesian language family, including a number of Polynesian languages (Potsdam & Polinsky 2011). The pseudocleft structure

¹⁴Given the existence of hyperraising in the language, one might wonder whether pre-verbal subjects of embedded clauses are accessible for exceptional case marking from the matrix clause. Based on the non-finite clause data that I present in Chapter 7, the answer appears to be no: transitive subjects of non-finite clauses require a last-resort Case-licensing mechanism, even when they should be candidates for Case assignment from the higher predicate. In this way, licensing behavior in Nukuoro non-finite clauses is somewhat inconsistent with the claim I make here, that pre-verbal subjects escape the CP phase.

There are two ways that this inconsistency could be explained. First, it is possible that different kinds of clauses—or different flavors of C—have different phasal properties. In this case, Nukuoro finite clauses would have the delayed opacity properties outlined above, allowing pre-verbal subjects to form further A-dependencies, while non-finite clauses would be fully opaque. While this opacity profile is the opposite of English, similar facts have been reported in Zulu (Halpert 2019). Alternatively, it is possible that Case licensing requirements in Nukuoro are domain-sensitive: all arguments must be Case-licensed within their clause, preventing Case assignment from the matrix clause from salvaging a Case licensing failure in the embedded clause.

I propose for (35a) is provided in (36): the *wh*/focus element is a predicate—which undergoes standard predicate fronting to the specifier of FP (see Chapter 4, §4.1)—while the remainder is a relative clause that appears in subject position in Spec, *vP*.¹⁵ The relative clause of a pseudocleft is typically headless: I assume that in a headless relative, the nominal that undergoes \bar{A} -movement to Spec, *CP*_{Rel} is null.

(36) Pseudocleft structure for (35a)

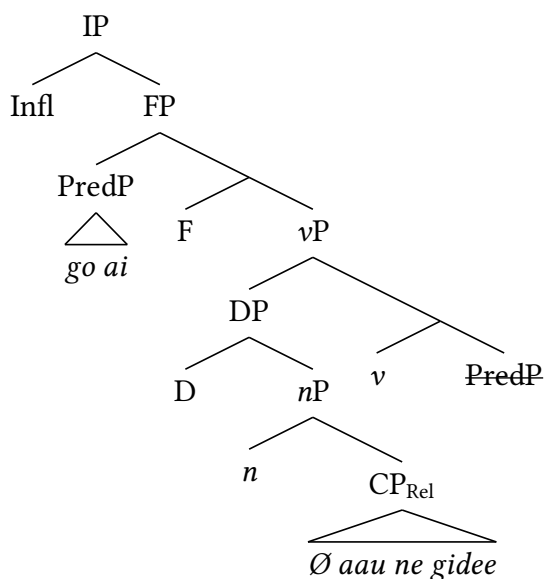

I briefly provide evidence for a pseudocleft analysis of Nukuoro *wh*-questions and focus constructions by showing that these structures are biclausal: (i) the fronted constituent is a predicate and (ii) the remainder of the clause is a headless relative clause.

The fronted constituent of a *wh*-question or focus construction is a predicate, as indicated by its similarity to non-verbal predication structures (see Chapter 3, §3.4.2) and its ability to host inflectional marking and predicate modifiers. As mentioned above, *wh*-words and focused nominals are typically preceded by the particle *go*, which also introduces definite nominal predicates in matrix clauses (37). I assume that *go* is a focus copula which forms predicates from DPs, as is consistent with descriptive characterizations of reflexes of Proto-Polynesian **ko* across the family (e.g., Clark 1976).

¹⁵In this way, pseudoclefts typically have post-verbal subjects (i.e., VSO order). As I laid out in Chapter 4, I assume that the interrogative *C*₂ in content questions only *optionally* selects for a *C*₁ that triggers subject movement. Pseudocleft questions can also have pre-verbal subjects, as shown in (i).

- (i) Tangada aau ne gidee laa go ai?
 DET.person 2SG.GEN.A PFV see DIST FOC who
 'The person that you saw is who?'

(JR-20200527)

- (37) a. Ia [**go** de meiolu o Nuguolu].
 3SG COP.FOC DET mayor GEN.O Nukuoro
 ‘S/he is the mayor of Nukuoro.’ (JR-RR-ML-20190627)
- b. [**Go** Soni] aagu ne gidee.
 COP.FOC Johnny 1SG.GEN.A PFV see
 ‘JOHNNY is who I saw.’ (JR-20190621)

Nominals marked by *go* are not the only predicative elements that can act as a *wh*-word or focus element: the fronted constituent may host any kind of predicate, including nominals preceded by the copula *se/ni* (38) and prepositional phrases (39).¹⁶

- (38) a. Ia [**se** doogidaa].
 3SG COP.SG doctor
 ‘S/he is a doctor.’ (JR-RR-ML-20190627)
- b. [**Se** aha] aau ne hagao?
 COP.SG what 2SG.GEN.A PFV buy
 ‘What did you buy?’ (JR-20190704)
- (39) a. Ia [**i** suguulu].
 3SG PREP school
 ‘S/he is at school.’ (JR-RR-ML-20190627)
- b. [**I** hee] olaadeu e hulo ai?
 PREP where 3PL.GEN.O IPFV go.PL OBL
 ‘Where are they going?’ (JR-20200527)

It is possible to get other predicative elements within the fronted constituent as well. Predicate modifiers like *angeange* ‘again’, which typically appear immediately after the verb (40a), can appear directly after the *wh*/focus constituent in a pseudocleft (40b). The fronted constituent can also include aspect marking, like perfective *ne* (41); note that the example in (41) shows two instances of aspect marking, clearly indicating that the structure is biclausal.

- (40) a. Soni gu llingi **angeange** de koovee.
 Johnny INC spill again DET coffee
 ‘Johnny spilled the coffee again.’ (JR-20200527)
- b. [**Go** ai **angeange**] ne llingia nei de koovee?
 COP.FOC who again PFV spill.CIA PROX DET coffee
 ‘Who spilled the coffee again?’ (JR-20200527)
- (41) [**Ne** hia] aau mamu **ne** hudi?
 PFV how.many 2SG.GEN.A fish PFV pull.in
 ‘How many fish did you pull in?’ (JR-20200527)

¹⁶See §3.4.2 of Chapter 3 for more details about non-verbal predication in Nukuoro, including a discussion of the status and function of the particles *se* and *ni*.

In addition to showing that the fronted constituent is a predicate, we can also observe that the remainder of the clause is a relative clause. A primary indicator of relative clause structure is the fact that pre-verbal subjects of *wh*- and focus constructions must appear in genitive case, indicating that they involve a GRC (42). Like GRCs, when subjects themselves are questioned or focused, no argument appears in genitive case (43).

- (42) a. Ni gulu aha [**a** Ruth ne hagabudu]?
 COP.PL breadfruit what GEN.A Ruth PFV gather
 ‘What kind of breadfruit did Ruth gather?’ (ML-20210820)
- b. Go denga gulu [**aana** ne gaiaa].
 COP.FOC DET.PL breadfruit 3SG.GEN.A PFV steal
 ‘BREADFRUIT is what she stole.’ (JR-20190704)
- (43) Go ai [ne daudali ange i de gaagoo]?
 FOC who PFV follow DIR.DIST PREP DET chicken
 ‘Who followed the chicken?’ (KR-20230609)

Relative clauses in *wh*- and focus constructions are typically headless, which is common for pseudocleft structures cross-linguistically (Potsdam & Polinsky 2011). Headless relative clauses are independently available in the language, as shown in (44), making it plausible that they exist in pseudoclefts as well.

- (44) E llanea [amaadeu ne gai].
 IPFV plenty 1PL.EXCL.GEN.A PFV eat
 ‘We ate plenty.’ (lit. ‘Plenty (what) we ate’) (JR-20200527)

It is also possible for the relative head of a pseudocleft to be overt; common overt heads for pseudoclefts include demonstratives (45a) and nouns like *mee* ‘thing’ or *dangada* ‘person’ (45b).

- (45) a. Go ai **dee-laa** aau ne gidee laa?
 COP.FOC who DET-PROX 2SG.GEN.A PFV see DIST
 ‘Who is that one that you saw?’ (JR-20230504)
- b. Go ai **tangada** aau ne gidee laa?
 COP.FOC who DET.person 2SG.GEN.A PFV see DIST
 ‘Who is the person that you saw?’ (JR-20200527)

Finally, *wh*-questions, focus constructions, and relative clauses all show the same restrictions on extraction, which is the focus of Chapter 6. The extraction of ergative arguments requires verbal morphology *-(C)ia/ina* to appear on the verb, as shown in (46); the extraction of oblique arguments requires resumption with the post-verbal oblique anaphor *ai*, as shown in (47).

- (46) a. tangada ne saabai ***(ina)** de gede
 DET.person PFV carry INA DET basket
 ‘the person who carried the basket’ (JR-20230504)

- b. Go au ne saabai ***(ina)** de gede.
 COP.FOC 1SG PFV carry INA DET basket
 ‘It’s ME who carried the basket.’ (ML-20210917)
- (47) a. de masovaa aagu ne gidee ***(ai)** taane laa
 DET time 1SG.GEN.A PFV see OBL DET.man DIST
 ‘the time that I saw that man’ (JR-20190621)
- b. Go anahee aau ne gidee ***(ai)** taane laa?
 COP.FOC when.PST 2SG.GEN.A PFV see OBL DET.man DIST
 ‘When did you see that man?’ (JR-20230504)

The shared restrictions on extraction between these three constructions is predicted by a shared relative clause structure.

5.3 Conclusion

In this chapter, I have demonstrated that relative clauses, *wh*-questions, and focus constructions all use the same underlying \bar{A} -mechanism, namely relativization. *Wh*-questions and focus constructions in Nukuoro are pseudoclefts, involving a fronted predicate *wh*/focus element and a (headless) relative clause. For this reason, I use relative clauses, *wh*-questions, and focus constructions interchangeably throughout the dissertation to investigate properties of \bar{A} -movement in the language: all three constructions involve \bar{A} -movement driven by C_{Rel} .

Most relative clauses in Nukuoro are genitive relative clauses (GRCs), where the subject of the relative clause appears in genitive case. Unlike what has been proposed for other Polynesian languages (e.g., Otsuka 2010b; Herd et al. 2011), I argue that genitive subjects in Nukuoro are internal to the relative clause and occupy the same position as pre-verbal matrix subjects, namely Spec,CP. In this position, pre-verbal subjects are outside of the CP phase and thus are accessible for further A-dependencies with higher structure, including genitive Case assignment as well as A-movement.

Chapter 6

Syntactic ergativity without inversion

A subset of ergative languages show ergative behavior in syntactic operations, a phenomenon known as syntactic ergativity (Dixon 1994). One particular type of syntactic ergativity that has garnered much attention is a restriction on the \bar{A} -extraction of ergative subjects, a phenomenon which has been identified in a number of genetically and areally diverse languages; for recent overviews, see Deal (2016b) and Polinsky (2017b). In such languages, the \bar{A} -movement strategy used for intransitive subjects and transitive objects (absolutives) cannot be used for transitive subjects (ergatives); instead, ergative extraction uses some kind of marked strategy, typically involving morphology on the verb or pronominal resumption of the ergative argument.

A large body of work has attempted to derive ergative extraction restrictions by appealing to case assignment and/or clause structure in syntactically ergative languages. Broadly speaking, analyses of ergative extraction restrictions can be divided into two categories: those that attribute the restriction to properties of the ergative subject itself (e.g., Polinsky 2016; Deal 2017b) and those that attribute the restriction to broader clause structural properties. The standard analysis of syntactic ergativity falls in the latter category, attributing restrictions on the \bar{A} -movement of ergatives to the systematic inversion of arguments in transitive clauses (Campana 1992; Ordóñez 1995; Bittner & Hale 1996a; Aldridge 2004, 2008; Coon et al. 2014; Assmann et al. 2015; Ershova 2019; Clemens & Tollan 2021; Coon et al. 2021; Tollan & Clemens 2022; Yuan 2022; Scott 2023). This view derives ergative extraction restrictions as a kind of intervention effect, where the subject cannot undergo movement past the intervening object. This configuration is schematized in (1).

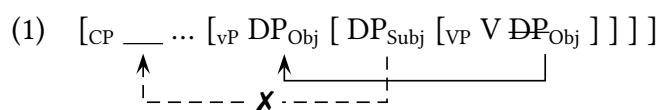

The inversion approach has become nearly ubiquitous in recent work, although the exact problem attributed to the configuration in (1) varies from account to account. Coon et al. (2014), for example, attribute the ergative extraction restriction to phasehood, arguing that object inversion effectively traps the transitive subject within the vP phase, preventing further subject movement. Other authors have attributed the restriction to a constraint on crossing dependencies (Campana 1992; Clemens & Tollan 2021; Tollan & Clemens 2022) or an \bar{A} -sensitivity to nominal

features, which leads to intervention by the high object (Aldridge 2004, 2008; Coon et al. 2021). Across these approaches, it is the presence of a nominal higher than the subject that yields a restriction on the movement of the transitive subject.

In this chapter, I describe and analyze a novel instance of syntactic ergativity in Nukuoro, a language which has basic SVO word order and shows no case marking on core arguments (2). \bar{A} -movement of intransitive subjects and transitive objects may proceed unhindered from basic clauses, as shown in (3a) and (3b); by contrast, transitive subjects may not undergo \bar{A} -movement from a regular transitive clause, as shown in (3c).

- (2) a. De gauligi ne gadagada.
 DET child PFV laugh.RED
 ‘The child laughed.’ (JR-20230106)
- b. De hine laa ne dau de beebaa.
 DET woman DIST PFV read DET book
 ‘That woman read the book.’ (JR-20230106)
- (3) a. Go ai ne gadagada?
 COP.FOC who PFV laugh.RED
 ‘Who laughed?’ (JR-20230106)
- b. Se aha a de hine laa ne dau?
 COP.SG what GEN.A DET woman DIST PFV read
 ‘What did the woman read?’ (JR-20230106)
- c. *Go ai ne dau de beebaa nei?
 COP.FOC who PFV read DET book PROX
 ‘Who read this book?’ (JR-20230106)

In order to \bar{A} -extract the transitive subject, an alternative construction must be used, which involves the verbal suffix *-(C)ia* plus the optional post-verbal particle *ina*, as shown in (4). This suffix-particle combination is the Nukuoro reflex of the well-known Polynesian voice/transitivity suffix *-Cia, which has a number of functions and morphological realizations across the family (Chung 1978; Cook 1996; Pawley 2001).

- (4) Go ai ne dau-**lia** (**ina**) de beebaa nei?
 COP.FOC who PFV read-CIA INA DET book PROX
 ‘Who read this book?’ (JR-20230106)

The Nukuoro extraction restriction is typologically and theoretically unusual as a result of two independent properties in the language. First, while it has been claimed that syntactic ergativity exclusively appears in morphologically ergative languages (e.g., Dixon 1994), Nukuoro shows no case marking on core arguments. In this way, Nukuoro severs classic ties between syntactically ergative behavior and ergative morphology. Second, I demonstrate that Nukuoro clauses do not involve object inversion: transitive subjects always occupy a position higher than transitive objects, as evidenced by word order and binding phenomena. Thus, the Nukuoro ergative extraction restriction cannot be analyzed using an inversion approach; instead, Nukuoro warrants

an analysis of syntactic ergativity that derives the restriction based on properties of the ergative argument itself, rather than properties of the absolutive object.

In light of these properties, I develop a case discrimination approach to syntactic ergativity, following Otsuka (2006, 2010a), Legate (2008a), and Deal (2016b, 2017b). I argue that syntactic ergativity arises when the probe responsible for triggering \bar{A} -movement is sensitive not only to $[\bar{A}]$ features, but also to Case features. Specifically, an ergative extraction restriction arises when an \bar{A} -probe is satisfied by two features, $[\bar{A}]$ and $[\text{ABS}]$, which must occur on the same head (i.e., a composite probe; Coon & Bale 2014; Colley & Privoznov 2020; Scott 2021). Since ergative subjects do not carry an $[\text{ABS}]$ feature, they are unable to satisfy the \bar{A} -probe and thus cannot undergo \bar{A} -movement. This mechanism is schematized in (5), using an Interaction-Satisfaction model of Agree (Deal 2015b, To appear).¹

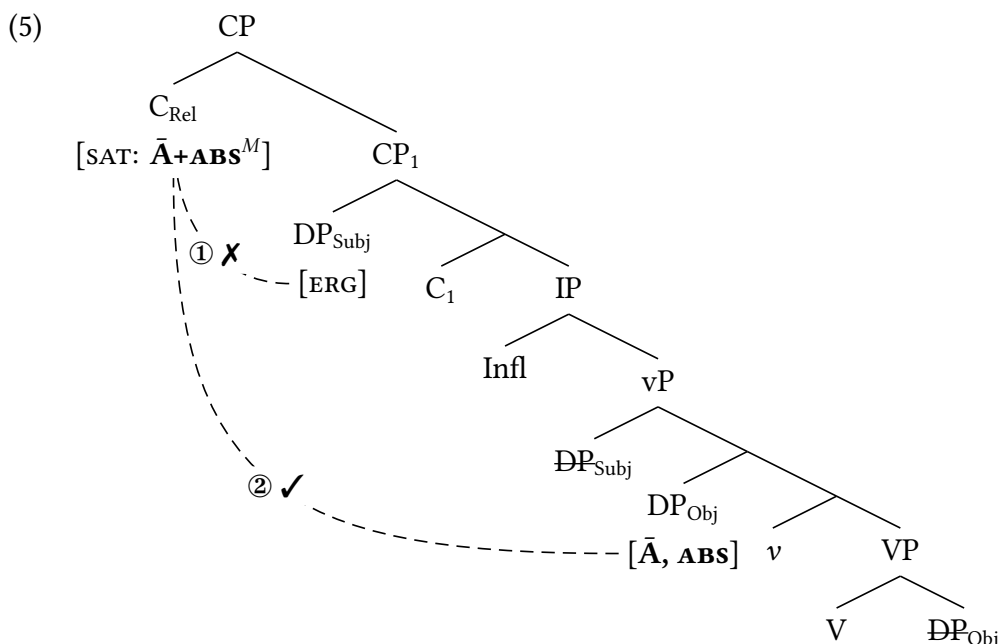

The present analysis is novel in that it formally implements case discrimination, but requires no case-specific or head-specific operations, such as “matching” (Otsuka 2006) or “bundling” (Legate 2012). Instead, case sensitivity is implemented using articulated probing, a mechanism which is independently necessary to capture highly-specified agreement patterns (e.g., the Person-Case Constraint; Coon & Keine 2021; Deal 2022) and instances of movement that have both A and \bar{A} properties (van Urk 2015; Erlewine 2018; Coon et al. 2021; Scott 2021).

To obviate the extraction restriction, I propose that $-(C)ia/ina$ realizes an additional v head, which I label v_{INA} , which appears above argument-introducing v and assigns an additional instance of absolutive Case to the transitive subject. This characterization of $-(C)ia/ina$ in Nukuoro

¹As I explain in more detail in §6.3.2, it is neither apparent nor relevant what the interaction condition of this probe is, since no features of the goal are ever realized on C. As in earlier chapters, I use a superscript M to indicate that satisfaction of the probe results in constituent movement (following Deal To appear).

accounts for the obviation of ergative extraction, as well as its appearance in transitive non-finite constructions and passive constructions. In other words, the Nukuoro repair strategy involves a bi-absolutive construction, where both arguments of a transitive clause receive absolutive Case. Such bi-absolutive constructions are attested in languages that show morphological case (e.g., Basque, Laka 2006; Lak and Tsez, Gagliardi et al. 2014) and have been likened to antipassive clauses, which are commonly used to obviate ergative extraction restrictions (Polinsky 2017a,b).

This work constitutes the first in-depth description of syntactic ergativity in Nukuoro, expanding our understanding of ergativity in Polynesian languages and cross-linguistically. A primary goal of this chapter is to expand the typology of (syntactic) ergativity, describing a novel case of an ergative extraction in a language that lacks both object inversion and overt morphological ergative case. This empirical pattern necessitates an account for syntactic ergativity which is independent of clause structure and morphological realization, as I provide here—a desirable result given the known heterogeneity of ergative systems (Johns 2000; Coon et al. 2017). An additional goal of this chapter is to unify work on ergative extraction restrictions with a recent body of literature on the articulation of Agree, which has shown that the Agree mechanism may be sensitive to properties that fall into both the A- and \bar{A} -domains. I show that case discrimination can be formalized using existing machinery, namely composite probing, which can be extended to account for a wide variety of extraction patterns cross-linguistically.

The rest of the chapter is organized as follows. Section 6.1 provides an overview of existing accounts of ergative extraction restrictions, including the large class of inversion-based analyses. In Section 6.2, I introduce the Nukuoro ergative extraction restriction and other uses of *-(C)ia/ina*; additionally, I provide evidence that Nukuoro clause structure does not involve object inversion to a position above the subject. The case discrimination analysis is fleshed out in Section 6.3, including an analysis of *-(C)ia/ina* as an absolutive Case licenser as well as extensions of this account to other languages. Section 6.4 addresses other non-inversion accounts, namely the accounts provided by Polinsky (2016) and Erlewine (2016). Section 6.5 concludes.

6.1 Analyses of ergative extraction restrictions

Existing accounts of ergative extraction restrictions fall into two broad categories, which I will call *inversion* accounts and *problematic ergative* accounts. Nearly all analyses in both classes connect ergative extraction restrictions to Case assignment, reflecting the generalization that such restrictions occur overwhelmingly in morphologically ergative languages (Dixon 1994).

6.1.1 Inversion accounts

The standard analysis of syntactic ergativity proposes that objects systematically move to a position higher than transitive subjects, resulting in the inversion of typical hierarchical relations. While this movement is sometimes claimed to be overt, resulting in word orders where the object precedes the subject (e.g., Clemens & Tollan 2021), for many languages object inversion is assumed to be covert (e.g., Bittner & Hale 1996a,b; Aldridge 2004; Coon et al. 2014, 2021). Move-

ment of the object is typically motivated by a need for the object to receive Case licensing from Infl, meaning that absolutive Case is effectively the same as nominative Case (e.g., Murasugi 1992; Bittner 1994; Bittner & Hale 1996a,b; Ura 2001; Legate 2008b). This configuration is schematized in (6).

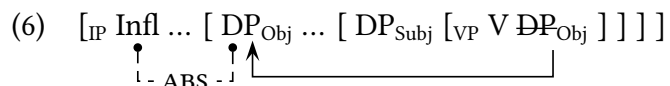

A Case motivation for object movement has two ramifications: first, object inversion is an instance of A-movement, since the object can receive Case in its derived position; and second, object inversion is obligatory, assuming that the object cannot be Case licensed in its base position. Even on analyses where object movement is not directly motivated by Case (e.g., Aldridge 2004; Coon et al. 2021; Scott 2023), these two properties hold: inversion is triggered by an [EPP] feature on *v*, resulting in obligatory A-movement of the object.

It is worth pointing out that object inversion alone does not derive syntactic ergativity: all analyses in this class require an additional mechanism to derive an ergative extraction restriction. After all, one of the core properties of \bar{A} -movement is that it can be non-local: nominals regularly \bar{A} -move over other nominals, a behavior which is standardly captured by the principle of relativized minimality (Rizzi 1990). In order to derive a movement restriction, movement of the object must prevent \bar{A} -movement of the subject in some other way: either because object movement and subject movement compete for the same position (e.g., Coon et al. 2014; Assmann et al. 2015), object movement creates a certain kind of dependency that cannot be crossed (e.g., Clemens & Tollan 2021) or because \bar{A} -movement is sensitive to nominal features, leading to a violation of minimality (e.g., Aldridge 2004; Coon et al. 2021). I briefly discuss these three kinds of explanations below.

A number of inversion accounts derive ergative extraction restrictions via competition for a single structural position, which allows for relationships with higher functional structure. This position tends to be characterized as an “escape hatch” from a clause-medial phase, such as Spec,vP (Coon et al. 2014), Spec,AspP (Ordóñez 1995), or Spec,TP (Assmann et al. 2015). On this style of account, ergative extraction contexts are ruled out because the subject and the object must both occupy this position: the object must move to this position in order to receive Case licensing from Infl, but the subject must move to this position in order to undergo further movement to Spec,CP. Note that on these accounts, \bar{A} -movement has no additional restrictions: subject \bar{A} -movement simply prevents object Case assignment, resulting in a licensing failure, or object movement for Case traps the subject within a lower phase, preventing subject \bar{A} -movement.

Alternatively, ergative extraction restrictions can be derived via constraints on \bar{A} -movement itself. Clemens & Tollan (2021) and Tollan & Clemens (2022) propose that movement in syntactically ergative languages is sensitive to a grammaticalized constraint on crossed dependencies: since the object moves over the subject to receive Case, \bar{A} -movement of the subject would result in an illicit crossed dependency. Other accounts propose that the syntactically ergative \bar{A} -probe is sensitive to nominal features as well as \bar{A} features (Aldridge 2004; Coon et al. 2021); as a result of inversion, the \bar{A} -probe will encounter the object first, preventing \bar{A} -movement of the lower sub-

ject. For Aldridge (2004), C carries an [EPP] feature which must be satisfied by the closest nominal, according to the principle of Attract Closest; for Coon et al. (2021), the probe on C searches for $[\bar{A}]$ and [D] simultaneously, resulting in an illicit configuration when the relevant features are found on two different goals (i.e., *feature gluttony*; Coon & Keine 2021). These accounts connect syntactic ergativity to a broader literature on mixed A/ \bar{A} -movement (e.g., Douglas 2018; Erlewine 2018; Branen & Erlewine 2022), a primary goal of the current chapter as well. My account follows in this vein, characterizing syntactic ergativity as an example of mixed A/ \bar{A} -movement, but without requiring an additional step of object inversion.

6.1.2 Problematic ergative accounts

While inversion-based accounts are considered to be standard, there are also several analyses which derive ergative extraction restrictions based on properties of the ergative argument itself. These accounts do not require object inversion to derive syntactic ergativity. I discuss three such analyses here: case discrimination accounts (Otsuka 2006, 2010a; Legate 2008a, 2012; Deal 2017b), prepositional ergative accounts (Polinsky 2016), and anti-locality accounts (Erlewine 2016).

Case discrimination accounts derive ergative extraction restrictions by proposing that the probe responsible for \bar{A} -movement is sensitive to Case distinctions. This sensitivity can be implemented in a wide variety of ways. Otsuka (2006) suggests that C carries a Case feature, which corresponds to the unmarked Case in the language (e.g., [NOM] or [ABS]); an argument which undergoes relativization must match the Case value borne by C. In a similar way, Legate (2008a, 2012) proposes that the relativization feature is bundled with Case, requiring Case and relativization to be checked together (i.e., by the same heads). While Otsuka (2006) and Legate (2008b) implement discrimination based on abstract Case, Deal (2017b) argues that accessibility is determined by a nominal's morphological form. Her proposal likens case-based extraction restrictions to case-discrimination in phi-agreement (e.g., Bobaljik 2008), arguing that Agree in general is mediated by a (morphological) case accessibility hierarchy, as in (7).

- (7) Case accessibility hierarchy (Otsuka 2006; Deal 2017b)
 unmarked case \ll marked case \ll lexical/oblique case

Deal's implementation captures Dixon's (1994) generalization that all languages which show syntactic ergativity also show morphological ergativity. However, as we will see, this correlation does not hold in Nukuoro, suggesting that a treatment based on morphological case cannot capture the Nukuoro restriction.

Aside from case discrimination, there are two other accounts of syntactic ergativity which do not rely on inversion, namely prepositional ergative accounts (Polinsky 2016) and anti-locality accounts (Erlewine 2016). Polinsky (2016) proposes that ergative extraction restrictions arise due to the prepositional nature of ergative case. On this view, ergative arguments are structurally PPs, introduced and case licensed by an overt or null P head. Ergative movement restrictions then result from simultaneous restrictions on preposition stranding and pied-piping: if the ergative preposition cannot move with the ergative argument or be stranded in its base position, the result is total ungrammaticality when movement is attempted.

Another analysis in the “problematic ergative” class developed by Erlewine (2016) does not actually take ergative *case* to be the problem, but rather the structural height of the ergative argument. On this account, ergative extraction restrictions can be attributed to anti-locality, a constraint which prevents movement from being too short (i.e., to the specifier of the next highest head). Concretely, Erlewine proposes that transitive subjects obligatorily move to Spec,TP; movement from this position to the next highest specifier position, Spec,CP, is not possible due to anti-locality principles. Intransitive subjects, on the other hand, occupy a position lower in the structure, circumventing anti-locality by moving to Spec,CP from a lower position.

The account that I adopt here for Nukuoro is an implementation of the case discrimination approach; in Section 6.4, I discuss the prepositional ergative and anti-locality accounts, concluding that these analyses fail to capture key aspects of the Nukuoro extraction restriction.

6.2 Syntactic ergativity without inversion

This section develops the primary empirical focus of the chapter, namely syntactic ergativity in Nukuoro. As previewed in the introduction, Nukuoro demonstrates a restriction on the extraction of ergative arguments (8a), which is “repaired” using the *-(C)ia* suffix and/or the post-verbal particle *ina* (8b).

- (8) a. * tangada ne saabai laa de gede
 DET.person PFV carry DIST DET basket
 Intended: ‘the person who carried the basket’ (JR-20230504)
- b. tangada ne saabai **ina** laa de gede
 DET.person PFV carry INA DIST DET basket
 ‘the person who carried the basket’ (JR-20230504)

While ergative extraction restrictions are typically analyzed as involving movement of the object over the subject, I demonstrate that Nukuoro clauses not involve object inversion: transitive subjects are the highest nominal in the clause, as evidenced by word order, subject-oriented A-dependencies, and binding patterns. The Nukuoro pattern thus requires us to develop a non-inversion analysis of syntactic ergativity, which I present in section 6.3.

6.2.1 Ergative extraction and *-(C)ia/ina*

-(C)ia/ina morphology appears in four contexts in Nukuoro: in ergative \bar{A} -movement contexts, as well as in passives, transitive imperatives, and transitive subjunctive clauses. The analysis that I present in this chapter aims to account for all four functions of *-(C)ia/ina*.

The Nukuoro *-(C)ia* suffix and the post-verbal particle *ina* are both reflexes of the well-known Polynesian *-Cia suffix (Chung 1978; Pawley 2001; Zanda 2023), whose functions and forms are well-studied but not yet well understood. *-Cia has a close relationship with case and alignment, though scholars do not agree on its original function or development: those who reconstruct Proto-Polynesian as ergative propose that *-Cia acted as a transitivity suffix (Clark 1973; Cook

1996), while those who reconstruct Proto-Polynesian as accusative propose that *-Cia acted as a passive suffix (Chung 1978; Seiter 1980; Ball 2007). In the modern languages, the functions of *-Cia vary widely, appearing in such disparate contexts as transitive subject displacement (i.e., \bar{A} -extraction, cliticization), passives, clauses with increased transitivity, imperatives, negated clauses, irrealis clauses, and perfective contexts.

6.2.1.1 Realizations of *-(C)ia/ina*

The morphological form of the Nukuoro *-(C)ia* suffix is highly idiosyncratic and lexically determined by the verb root to which it attaches. The C represents a so-called “thematic” consonant, which originated as the final consonant of the verb root and has been reanalyzed as part of the suffix (Pawley 2001). As a result, the thematic consonant cannot be predicted from the identity of the base, and has undergone a large amount of morphological leveling. Verb roots that are affixed with *-(C)ia* may undergo a number of morphological changes in Nukuoro: the suffix may take the form *-Cia*, *-ia*, or *a*, the root may undergo vowel lengthening, and some roots do not change at all, as exemplified in Table 6.1.

VERB MEANING	BARE FORM	CIA FORM	MORPHOLOGICAL CHANGE
‘catch’	<i>poo</i>	<i>boogia</i>	[add underlying C + <i>ia</i>]
‘pull in (fish)’	<i>hudi</i>	<i>huudia</i>	[lengthen V + <i>ia</i>]
‘weave’	<i>llanga</i>	<i>llaanga</i>	[lengthen V]
‘slap’	<i>hagaili</i>	<i>hagailia</i>	[add <i>a</i>]
‘clear debris’	<i>velevele</i>	<i>velevele</i>	[no change]

Table 6.1: Idiosyncratic forms of verbs marked by *-(C)ia*

In nearly all Polynesian languages, an invariant form of *-Cia has developed as a distinct, debonded particle, which may be used in addition to the verbal suffix (Cook 1996:59; Chung 1978:57, 284; Mosel & Hovdhaugen 1992:198, 743; Ota 2000:130-131; Zanda 2023). The identity of the thematic consonant in the invariant form varies widely across languages, even in those which are closely related: in Hawai’ian, for instance, the invariant form is *’ia* (Elbert & Pukui 1979), while in Maori, the invariant form is *tia* (Harlow 2007). In Nukuoro, the invariant particle is *ina*, a metathesized form of *-(C)ia* (Pawley 2001:194, Zanda 2023).² *Ina* is not a suffix, but a post-verbal particle: it may be separated from the verb root, typically appearing after manner adverbs but before directionals (9).

²While some recent analyses have taken *-Cia to be a resumptive pronoun (e.g., Hopperditzel 2020), Pawley (2001) argues convincingly that *-Cia arose from the combination of the transitivizing suffix *-Ci plus the stative suffix *-a. Even if *-Cia had a historical connection to pronominalization, all diachronic accounts agree that reflexes of *-Cia in Nuclear Polynesian are no longer synchronically pronominal (e.g., Churchward 1951:74; Clark 1973:593).

- (9) Go ai ne huudia maalie **ina** mai de mamu?
 COP.FOC who PFV pull.in.CIA slowly INA DIR.PROX DET fish
 ‘Who pulled in the fish slowly?’ (JR-20230302)

The *-(C)ia* suffix and the invariant particle *ina* are exponents of the same syntactic category in Nukuoro, which often co-occur in a pattern of multiple exponence (Zanda 2023).³ When the verb root has a suffixed *-(C)ia* form, the addition of *ina* is optional; however, if the verb root does not have a suffixed *-(C)ia* form, *ina* is obligatory (10). The following examples show *-(C)ia/ina* in its passive function (see §6.2.1.3).

- (10) a. Soni ne **boogia (ina)** mai i denga biliisimani.
 Soni PFV catch.CIA INA DIR.PROX PREP DET.PL police
 ‘Johnny was caught by the police.’ (JR-20190628)
- b. De gaadinga gu **velevele *(ina)** i de goe.
 DET coconut INC clean INA PREP DET 2SG
 ‘The coconut was cleaned by you.’ (JR-20190628)

6.2.1.2 The ergative extraction restriction

In Nukuoro relativization, the \bar{A} -movement of transitive subjects is unlike the \bar{A} -movement of other core arguments. In *wh*-questions, for example, intransitive subjects and transitive objects are relativized using an unmarked gap in base position (11).

- (11) a. Go ai e anu naa?
 COP.FOC who IPFV dance IRR
 ‘Who is dancing?’ (JR-20190605)
- b. Go ai a denga biliisimani ne doolohi laa?
 COP.FOC who GEN.A DET.PL police PFV chase DIST
 ‘Who did the police chase?’ (JR-20230504)

Transitive subjects, however, cannot be relativized using the same unmarked strategy (12a). Instead, relativizing a transitive subject requires *-(C)ia/ina* to appear on the verb (12b).

- (12) a. *Go ai ne doolohi Soni?
 COP.FOC who PFV chase Soni
 ‘Who chased Johnny?’ (JR-20230504)
- b. Go ai ne **dolohia (ina)** Soni?
 COP.FOC who PFV chase.CIA INA Soni
 ‘Who chased Johnny?’ (JR-20230504)

³The morphological realization of *-(C)ia/ina* can be implemented in a number of different ways. For concreteness, I propose that the functional head associated with *-(C)ia/ina* may be realized as a null morpheme (\emptyset) or the overt particle *ina*. Verbal allomorphy (i.e., the verb’s *-(C)ia* form) is then conditioned by the presence of this functional head. The choice of whether or not to pronounce *ina* comes down to economy of realization: if the presence of *ina* conditions overt verbal allomorphy, pronouncing *ina* is redundant, and thus is only optionally realized.

This relativization strategy occurs in all transitive clauses where the subject is extracted: *wh*-questions, as seen above, as well as relative clauses (13) and focus constructions (14).

- (13) Au ne gidee [tangada ne **unu ina** denga vai].
 1SG PFV see DET.person PFV drink INA DET.PL water
 'I saw the person who drank the water.' (JR-20190706)
- (14) Go Sigi ne **dolohia (ina)** denga gaagoo.
 COP.FOC Sigi PFV chase.CIA INA DET.PL chicken
 'It was Sigi who chased the chickens.' (JR-20210628)

-(C)ia/ina appears when the subject is extracted from all and only syntactically transitive constructions, defined as constructions that take (at least) two DP arguments. Aside from basic transitives, *-(C)ia/ina* is also obligatory when the subject DP is extracted from ditransitive constructions (15) and derived transitive constructions (16), which are formed by adding the causative prefix *haga-* to an intransitive verb.

- (15) Go ai ne gaavange **ina** de beebaa gi Soni?
 COP.FOC who PFV give INA DET book to Soni
 'Who gave the book to Johnny?' (JR-20190605)
- (16) Go ai e haga-baguu **ina** ia?
 COP.FOC who IPFV CAUS-fall INA 3SG
 'Who tripped him?' (JR-20190605)

By contrast, *-(C)ia/ina* cannot appear when the subject of an intransitive verb is extracted (17a), nor can it appear under extraction of subjects of middles (17b). This contrast suggests that the extraction restriction is sensitive to transitivity, rather than thematic roles.

- (17) a. Go ai e gadagada (*ina) naa?
 COP.FOC who IPFV laugh INA IRR
 'Who is laughing?' (JR-20190605)
- b. Go ai ne daudali (*ina) ange gi taane laa?
 COP.FOC who PFV follow INA DIR.DIST to DET.man DIST
 'Who followed that man?' (ML-20210709)

Long-distance \bar{A} -extraction of an embedded transitive subject requires *-(C)ia/ina* on the embedded verb, but does not allow this morphology on the matrix verb. This is shown for complements of belief verbs (18), which use the complementizer *bolo*, as well as complements of perception verbs (19), which do not use a complementizer.

- (18) Go ai aana ne maanadu (*ina) laa [bolo ne **buuludi ina** ange Johnny]?
 COP.FOC who 3SG.GEN.A PFV think INA Q that PFV hug INA DIR.DIST Johnny
 'Who does s/he think hugged Johnny?' (JR-20190604)

- (19) Go ai aau ne gidee (*ina) laa [e **dolohia (ina)** Soni]?
 COP.FOC who 2SG.GEN.A PFV see INA Q IPFV chase.CIA INA Johnny
 ‘Who did you see chasing Johnny?’ (JR-20210628)

In other words, the ergative extraction restriction affects only those transitive verbs whose subjects are extracted, not all clauses that \bar{A} -movement proceeds through. This behavior demonstrates that the appearance of $-(C)ia/ina$ cannot be analyzed as a reflex of successive-cyclic movement (e.g., Georgi 2014, 2017) and instead reflects the relationship between the \bar{A} -extracted element and its own clause.

Finally, there is one additional way to obviate the extraction restriction: incorporation of the object as a bare noun. When the object is a DP, ergative extraction requires $-(C)ia/ina$, a fact that is replicated in (20a). However, if the object is a bare noun that has been incorporated, the subject can undergo extraction without the use of $-(C)ia/ina$, as shown in (20b).⁴

- (20) a. tamaa gauligi laa e [_{VP} gai*(-na)] denga gahudi i masoaa alodahi.
 DET.child young DIST IPFV eat-CIA DET.PL banana PREP time all
 ‘that kid who eats the bananas all the time.’ (JR-20210604)
- b. tamaa gauligi laa e [_{VP} gai gahudi] i masoaa alodahi.
 DET.child young DIST IPFV eat banana PREP time all
 ‘that kid who eats bananas all the time.’ (JR-20210604)

The fact that object incorporation contexts no longer require $-(C)ia/ina$ further emphasizes the conclusion that $-(C)ia/ina$ is restricted to syntactically transitive verbs (i.e., those with two DP arguments).

6.2.1.3 Other uses of $-(C)ia/ina$

In addition to ergative extraction, Nukuoro $-(C)ia/ina$ appears in three other contexts: (i) passive constructions; (ii) transitive imperatives; and (iii) transitive subjunctive clauses. These three additional functions better contextualize the appearance of $-(C)ia/ina$ in ergative extraction.

First, $-(C)ia/ina$ appears in passive constructions, where the patient is promoted to pre-verbal subject position and the agent is demoted to an optional oblique phrase marked with the general preposition *i*. Passivization with $-(C)ia/ina$ is only possible for predicates that take two DP arguments, including canonical transitives (21) and derived transitives (22).

- (21) a. De gauligi ne doolohi de gaagoo.
 DET child PFV chase DET chicken
 ‘The child chased the chicken.’ (ML-20210723)

⁴It is still possible to add $-(C)ia/ina$ to the example in (20b); I assume that this behavior reflects the fact that bare objects in Nukuoro may optionally undergo movement out of VP, as argued in Chapter 4 §4.2. In other words, it is ambiguous whether the object in (20b) is inside or outside of the fronted VP. When the object is incorporated, it obviates the extraction restriction, as demonstrated here; however, if the object undergoes movement, the restriction remains and $-(C)ia/ina$ is obligatory, similar to (20).

- b. De gaagoo gu doolohi **ina** (i de gauligi).
 DET chicken INC chase INA PREP DET child
 ‘The chicken was chased (by the child).’ (ML-20210723)
- (22) a. Gilaadeu gu haga-duu d-ogu hale.
 3PL INC CAUS-stand DET-1SG.GEN.O house
 ‘They built my house.’ (JR-20190628)
- b. D-ogu hale ne haga-duu-**lia** (**ina**) (i de gau laa).
 DET-1SG.GEN.O house PFV CAUS-stand-CIA INA PREP DET people DIST
 ‘My house was built (by those people).’ (JR-20190628)

It is impossible to passivize verbs that do not have DP objects, such as middle verbs (23) or intransitive verbs (24).

- (23) a. Denga biliisimani ne daudali ange i taane laa.
 DET.PL police PFV follow DIR.DIST PREP DET.man DIST
 ‘The police followed that man.’ (JR-20230106)
- b. *Taane laa ne daudali **ina** ange (i denga biliisimani).
 DET.man DIST PFV follow INA DIR.DIST PREP DET.PL police
 Intended: ‘That man was followed (by the police).’ (JR-20230106)
- (24) a. De gauligi ne seni i hongade hagahala.
 DET child PFV sleep PREP top DET sleeping.mat
 ‘The child slept on the mat.’ (JR-20230106)
- b. *De hagahala ne seni **ina** (i de gauligi).
 DET mat PFV sleep INA PREP DET child
 Intended: ‘The mat was slept on (by the child).’ (JR-20230106)

One might assume that passive is the basic function of *-(C)ia/ina*, as has been claimed for Eastern Polynesian languages like Māori (Bauer 1993; Harlow 2007) and Hawai’ian (Elbert & Pukui 1979). On this analysis, *-(C)ia/ina* morphology would realize passive voice itself, which could obviate ergative extraction by demoting the transitive subject to an oblique phrase. However, it is important to note that ergative extraction contexts show markedly different behavior than \bar{A} -extraction from passivized clauses. When the demoted agent of a passive undergoes \bar{A} -movement, it must undergo resumption using the resumptive pronoun *ai*, which is true of all oblique \bar{A} -movement.⁵ Additionally, the promoted patient argument is marked with genitive case, identifying it as the subject of the relative clause (25).

- (25) Go ai o **Soni** ne duugia ina **ai** laa?
 COP.FOC who GEN.O Johnny PFV hit.CIA INA OBL Q
 ‘Who was Johnny hit by?’ (JR-20200507)

⁵I discuss resumption under oblique extraction further in section 4.2.

By contrast, ergative extraction clauses cannot show either of these properties. Extracted ergative arguments cannot undergo resumption with *ai* (26a), and the patient argument cannot appear pre-verbally in genitive case, suggesting that it has not been promoted to subject (26b).⁶

- (26) a. *Go ai ne duugia ina **ai** laa Soni?
 COP.FOC who PFV hit.CIA INA OBL Q Soni
 Intended: ‘Who hit Johnny?’ (JR-20200507)
 JR: “The *ai* should not be in there.”
- b. *Go ai o **Soni** ne duugia ina?
 COP.FOC who GEN.O Soni PFV hit.CIA INA
 Intended: ‘Who hit Johnny?’ (JR-20200507)

These differences show that *-(C)ia/ina* cannot be characterized as a passive in all contexts.

There are two additional constructions where *-(C)ia/ina* is found, namely transitive imperatives and transitive subjunctive clauses. These constructions can be grouped together as non-finite contexts: they lack canonical aspect marking, which I take to indicate a lack of finite Infl. Like ergative extraction contexts with *-(C)ia/ina*, transitive non-finite clauses do not appear to be passivized in any way: neither argument is demoted or promoted.

Imperative constructions in Nukuoro lack aspect marking and have a null or implied 2nd person subject. Intransitive and middle imperatives use a standard unmarked verb form, while transitive imperatives cannot appear in their bare form and instead appear with *-(C)ia/ina* (27).

- (27) a. Anu (*ina) matali au.
 dance INA with me
 ‘Dance with me.’ (ML-20210723)
- b. Daudali (*ina) ange gi taane laa.
 follow (ina) DIR.DIST to DET.man DIST
 ‘Follow that man.’ (ML-20210723)
- c. Hao **(ina)** de hoe gi lote moni.
 put.in INA DET paddle to inside.DET canoe
 ‘Put the paddle inside the canoe.’ (JR-20190624)

Similar facts hold of subjunctive clauses, which are marked by the subjunctive particle *gi* and are optionally introduced by the complementizer *bolo* (28).

- (28) a. Ia e lodo (bolo) Mina **gi** anu.
 3SG IPFV want COMP Mina SBJV dance
 ‘S/he wants Mina to dance.’ (JR-20210628)
- b. Au gu dugu Mea **gi** gai-na denga mee maimai.
 1SG INC allow Mea SBJV eat-CIA DET.PL thing sweet
 ‘I allowed Mea to eat candy.’ (JR-20211005)

⁶Thanks to Michelle Yuan for pointing out these key differences between passivization and ergative extraction.

Gi-clauses are also non-finite, in the sense that they are invariant for tense/aspect and cannot appear with aspect markers (30).

- (29) a. Au **e** lodo (bolo) [Mina **gi** hano (daiao)].
 1SG IPFV want COMP Mina SBJV go.SG tomorrow
 ‘I want Mina to leave (tomorrow).’ (JR-20210923)
- b. Au **ne** lodo (bolo) [Mina **gi** hano (anaahi)].
 1SG PFV want COMP Mina SBJV go.SG yesterday
 ‘I wanted Mina to leave (yesterday).’ (JR-20210923)
- (30) a. Au **ne** lodo (bolo) [Mina **gi** {*e / *ne / *nogo} seni anaahi].
 1SG PFV want COMP Mina SBJV IPFV / PFV / PROG sleep yesterday
 ‘I wanted Mina to { sleep / be sleeping / have slept } yesterday.’ (JR-20210923)
- b. Au **ne** lodo (bolo) [Mina {*e / *ne / *nogo} **gi** seni anaahi].
 1SG PFV want COMP Mina IPFV / PFV / PROG SBJV sleep yesterday
 ‘I wanted Mina to { sleep / be sleeping / have slept } yesterday.’ (JR-20210923)

In Chapter 4, I argued that subjunctive *gi* is a low complementizer which is incompatible with finite Infl: material in Infl typically undergoes T-to-C movement (Massam 2000, 2001; Custis 2004; Otsuka 2005; Collins 2017; Middleton 2021), which is blocked by the presence of *gi* in C. As a result, clauses with *gi* select for a non-finite form of Infl, which has no morphological realization.

Like imperative clauses, intransitive and middle clauses with *gi* require an unmarked verb form (31), while transitive clauses with *gi* require the verb to appear with *-(C)ia/ina* (32). Note that the subject does not appear to be displaced or raised into the matrix clause in (32), as it can appear to the right of the complementizer *bolo*.

- (31) a. Au **ne** dugu ange (bolo) Mina **gi** anu (*ina).
 1SG PFV allow DIR.DIST COMP Mina SBJV dance INA
 ‘I allowed Mina to dance.’ (JR-20230106)
- b. Au **ne** dugu ange (bolo) Mina **gi** daudali ange (*ina) i taane laa.
 1SG PFV allow DIR.DIST COMP Mina SBJV follow DIR.DIST INA PREP DET.man DIST
 ‘I allowed Mina to follow that man.’ (JR-20230106)
- (32) a. * Au **ne** dugu (bolo) Mina **gi** hudi dahi mamu.
 1SG PFV allow COMP Mina SBJV pull.in one fish
 ‘I allowed Mina to catch a fish.’ (JR-20210923)
- b. Au **ne** dugu (bolo) Mina **gi** **huudia** (**ina**) dahi mamu.
 1SG PFV allow COMP Mina SBJV pull.in.CIA INA one fish
 ‘I allowed Mina to catch a fish.’ (JR-20210923)

In all of these contexts, including ergative extraction, *-(C)ia/ina* only appears when the verb selects for two DP arguments: it is incompatible with intransitives and middles, suggesting that its function is related to transitivity in some way.

6.2.2 Nukuoro lacks inversion

As mentioned in §6.1, a large class of analyses relies on systematic inversion of the object to derive ergative extraction restrictions (Campana 1992; Aldridge 2004; Coon et al. 2014, 2021; Clemens & Tollan 2021; Tollan & Clemens 2022). For this reason, the position of the transitive object in Nukuoro is crucial to developing an analysis of syntactic ergativity in the language.

Like many Polynesian languages, Nukuoro clause structure involves object shift followed by fronting of the remnant VP (as discussed in Chapter 4). However, the landing site of object movement could in principle be above the transitive subject, as has been argued for Tongan (Clemens & Tollan 2021), or below the transitive subject, as has been argued for Samoan (Collins 2017; Tollan 2018) and Niuean (Massam 2001; Longenbaugh & Polinsky 2018). These two analytic possibilities can be schematized as follows. In an object inversion structure (e.g., Clemens & Tollan 2021), shown in (33), the DP object vacates the VP and moves to an outer specifier of *v*P, above the base position of the transitive subject. For simplicity, these schemas do not include VP fronting, which occurs after the object has vacated the VP.

(33) *Inversion analysis*

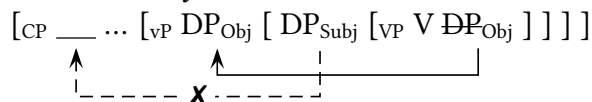

If the structure in (33) holds in Nukuoro, we could adopt any number of inversion-based analyses to account for the ergative extraction restriction.

The inversion structure should be contrasted with a non-inversion alternative (e.g., Massam 2001; Collins 2017; Longenbaugh & Polinsky 2018; Tollan 2018), where the DP object vacates the VP and moves to an *inner* specifier of *v*P, “tucking in” below the transitive subject (34). In this structure, the subject remains higher than the object throughout the derivation.

(34) *Non-inversion analysis*

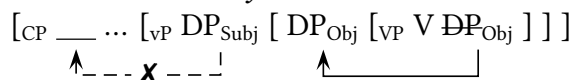

I argue in favor of the non-inversion analysis for Nukuoro: transitive subjects remain higher than objects throughout the course of the derivation, as evidenced by word order, subject A-dependencies, and binding patterns. This claim precludes us from adopting one of the many inversion-based analyses for the Nukuoro extraction restriction, and leads us to focus instead on properties of the transitive subject to derive the restriction.

First and foremost, we can observe that all permissible Nukuoro word orders place the subject linearly before the object; this behavior falls out straightforwardly if subjects occupy a position higher than transitive objects at all stages of the derivation. As described in Chapter 4, Nukuoro clauses are typically SVO: subjects surface most naturally in the pre-verbal position, where they appear unmarked (35). This position can be used for subjects of (unergative and unaccusative) intransitive verbs (35a-b), middle verbs (35c), and transitive verbs (35d).

- (35) a. **De gauligi** ne baguu.
 DET child PFV fall
 ‘The child fell.’ (JR-20230504)
- b. **De gauligi** ne anu.
 DET child PFV dance
 ‘The child danced.’ (JR-20230504)
- c. **De gauligi** ne daudali ange i de gaaduu.
 DET child PFV follow DIR.DIST PREP DET dog
 ‘The child followed the dog.’ (JR-20230504)
- d. **De gauligi** ne gai de gahudi.
 DET child PFV eat DET banana
 ‘The child ate the banana.’ (JR-20220627)

It is not possible for any other elements, such as objects (36a) or adjuncts (36b), to appear in the pre-verbal position.

- (36) a. *De gahudi ne gai **de gauligi**.
 DET banana PFV eat DET child
 Intended: The child ate the banana.’ (JR-20220627)
 JR: ‘No. When you say it this way, it’s the banana that’s eating the baby.’
- b. *Anaahi ne hai **gimaadeu** dahi daonga.
 yesterday PFV do 1PL.EXCL one party
 Intended: ‘Yesterday we had a party.’ (JR-20220627)

Verb-initial orders are also possible in the language, such as in relative clauses, polar questions, and adjunct *when*- and *if*-clauses. In these clauses, VSO word orders are permitted but VOS orders are prohibited, as shown in (37) and (38).⁷

- (37) a. Ne llanga **goe** denga gede?
 PFV weave 2SG DET.PL basket
 ‘Did you weave the basket?’ (JR-20230504)
- b. *Ne llanga denga gede **goe**?
 PFV weave DET.PL basket 2SG
 Intended: ‘Did you weave the basket?’ (JR-20230504)
- (38) a. Ga gai naa huu **de gauligi** de gahudi, gai ia ga magi.
 PRSP eat IRR when DET child DET banana then 3SG PRSP sick
 ‘If the child eats the banana, s/he will be sick.’ (JR-20220627)

⁷VOS orders are only possible if the object is an N⁰ that has been incorporated into the verb; as explained in Chapter 4, this order is derived via fronting of the entire VP, including the incorporated object, to a position above the base position of the subject. VOS word order is impossible with two DP arguments.

- b. *Ga gai naa huu de gahudi **de gauligi**, gai ia ga magi.
 PRSP eat IRR when DET banana DET child then 3SG PRSP sick
 Intended: ‘If the child eats the banana, s/he will be sick.’ (JR-20220607)
 JR: This is more improper, because it’s like saying “If the banana eats the baby...”

On a simplistic view of object inversion, the fact that objects cannot linearly precede subjects suggests that there is no inversion in the language. However, languages argued to have inversion do not always reflect this movement straightforwardly through word order: there are languages with basic VOS word order that do not show evidence of inversion, such as Ch’ol (Mayan; Clemens & Coon 2018), as well as languages with basic VSO/SOV word orders that *do* show evidence of inversion, such as Kalaallisut (Inuit; Bittner 1994; Bittner & Hale 1996b) and Chuj (Mayan; Royer 2022). In this second group of languages, object inversion is assumed to be covert: the object always undergoes A-movement to a position higher than the subject, but only the lower copy of the object is pronounced. A covert inversion analysis is schematized in (39), where an unpronounced copy of the object c-commands the subject, preventing further \bar{A} -movement of the subject.

- (39) *Covert inversion of the object*
- $$[CP \text{ --- } \dots [_{vP} \overline{DP}_{Obj} [DP_{Subj} [_{VP} V DP_{Obj}]]]]$$
-

Even so, positing covert inversion in Nukuoro does not get around the fact that subjects appear most often in a high, pre-verbal position, which I argue in Chapter 4 to be Spec,CP. Even if objects undergo covert movement like that schematized in (39), subjects must still be able to A-move over the unpronounced copy of the object to this position, resulting in SVO word order. The availability of SVO word order speaks against even a covert inversion account for two reasons. First, it is puzzling why subject \bar{A} -movement should be hindered by a high object, but subject A-movement would not. Additionally, if subjects regularly end up in a high pre-verbal position, there should be a derivation available where the probe that triggers \bar{A} -movement considers the subject first—even if there is inversion lower in the structure.

There are two additional pieces of evidence that covert object inversion is not occurring in Nukuoro. While covert inversion would not create new word order possibilities, it should still have syntactic and/or interpretive effects. For instance, we might expect higher A-dependencies to target transitive objects but not transitive subjects; furthermore, we predict that covert object inversion would reverse Condition C effects (Royer 2022), allowing objects to bind into subjects, but not vice versa. In what follows, I show that neither of these predictions is borne out in Nukuoro, suggesting that Nukuoro clauses do not involve covert object inversion.

First, A-dependencies in Nukuoro regularly target intransitive and transitive subjects to the exclusion of objects. One such A-dependency is movement to pre-verbal subject position; another is genitive case assignment to subjects in clausal nominalizations. Nominalized clauses in Nukuoro are large enough to include predicate fronting, which targets the specifier of a projection FP just above *vP*. As such, nominalized clauses are large enough to involve object movement to Spec,*vP*. A schema of a nominalized clause is provided in (40).

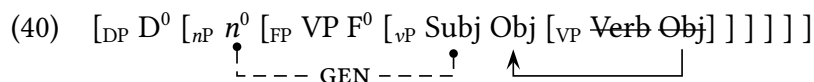

In Chapters 5 and 7, I show that subjects of relative clauses and nominalized clauses are assigned genitive case (41a-b), which I argue is assigned by the higher nominalizing n^0 to the closest DP. Crucially, objects can never be genitive-marked in these contexts (41c), providing further evidence that objects are not the highest nominal in a transitive clause.

- (41) a. de seesee ange o luu daane nei
 DET walk DIR.DIST GEN.O DET.DU man PROX
 ‘the walking of these two men’ (Otto, 11-5, line 24)
- b. de tala ange a de bodu muna nei
 DET tell DIR.DIST GEN.A DET spouse word PROX
 ‘the spouse’s telling of these words’ (Haini, 12-1, line 81)
- c. *de hai ange de hine laa a/o de hada
 DET fix DET woman DIST GEN DET car
 Intended: ‘the woman’s fixing of the car’ (JR-20230504)

Second, covert object inversion should affect binding patterns in the language, since the higher unpronounced copy of the object c-commands the subject. Assuming that object inversion is an instance of A-movement (e.g., Coon et al. 2021), which does not reconstruct for Condition C (see e.g., Chomsky 1995; Fox 1999; Lasnik 1999; Takahashi 2010; Legate 2014), object inversion should yield a reversal of Condition C effects in transitive clauses (Royer 2022). This prediction is not borne out in Nukuoro, which shows standard Condition C effects in transitive clauses, including those which are verb-initial. Nukuoro does not have a dedicated reflexive pronoun; instead, basic pronouns that are c-commanded by an R-expression may be interpreted as disjoint or reflexive depending on context. Example (42a) shows that an R-expression in subject position can bind a pronoun in object position, which can also be interpreted as disjoint. However, as (42b) shows, a pronoun in subject position cannot be bound by an R-expression in object position, and only the disjoint reading remains.

- (42) a. Ga gidee naa huu Ruth_i ia_{i/j} i lote ada nei...
 PRSP see IRR when Ruth 3SG PREP inside.DET picture PROX
 ‘If Ruth sees her/herself in this picture...’ (JR-20220727)
- b. Ga gidee naa huu ia_{*i/j} Ruth_i i lote ada nei...
 PRSP see IRR when 3SG Ruth PREP inside.DET picture PROX
 ‘If she/*herself sees Ruth in this picture...’ (JR-20220727)

If the object covertly A-moved above the subject in Nukuoro, we would predict the facts to be reversed: the co-referential interpretation in (42a) should yield a Condition C violation, since the object pronoun would A-move to a position c-commanding the transitive subject, while the violation in (42b) should be ameliorated by inversion of the object R-expression. In order to salvage the covert inversion view, one could claim that object A-movement optionally reconstructs

in (42a) in order to avoid a Condition C violation. However, note that in (42b), reconstruction would need to be *obligatory* to rule out the co-referent interpretation, forcing a Condition C violation; it is difficult to understand why the object R-expression in (42b) would need to reconstruct, when interpretation in its higher position would allow the co-referent reading.

Similar facts hold of pronouns that are not reflexively interpreted: an R-expression in the subject can bind a possessive pronoun contained within the object (43a), but a pronoun contained within the subject cannot be bound by an object R-expression (43b).⁸

- (43) a. Ga gidee naa huu **Soni_i** d-ono_{i/j} dinana i lote ada...
 PRSP see IRR when Soni DET-3SG.GEN.O mother PREP inside.DET picture
 ‘If Johnny_i sees his_{i/j} mother in the picture, he will cry.’ (JR-20220727)
- b. Ga gidee naa huu **d-ono_{i/j}** **dinana** Soni_i i lote ada...
 PRSP see IRR when DET-3SG.GEN.O mother Soni PREP inside.DET picture
 ‘If his_{i/j} mother sees Johnny_i in the picture...’ (JR-20220727)

Again, these facts suggest that the object does not undergo covert A-movement in Nukuoro; otherwise, we predict that a bound reading of the possessive pronoun should be possible in (43b).

In sum, the Nukuoro word order and binding facts make it difficult to adopt an analysis with object inversion, which would need to be phonologically, syntactically, and semantically covert—and thus effectively untestable. It is rather straightforward, on the other hand, to assume that objects move to a position *below* the transitive subject, namely an inner specifier of ν P. Importantly, this structural claim means that inversion-based analyses of syntactic ergativity are simply untenable for Nukuoro: the object never intervenes between the transitive subject and a higher \bar{A} -position. Instead, a subject-highest syntax in Nukuoro requires us to capture the ergative extraction restriction using an alternative analysis which does not rely on the position of the object.

6.2.3 Interim summary

Nukuoro shows a restriction on the \bar{A} -movement of transitive subjects (i.e., ergative arguments), which may be obviated by the use of *-(C)ia/ina* or incorporation of the object. Furthermore, the Nukuoro ergative extraction restriction does not occur alongside object inversion. The core desiderata for an analysis of Nukuoro syntactic ergativity are summarized in (44).

- (44) Properties related to Nukuoro syntactic ergativity
- a. Subjects of transitive verbs (i.e., those with two DP arguments) may not undergo unmarked \bar{A} -movement.

⁸In theory, it should be possible to get accidental co-reference between the possessor pronoun and the object R-expression in (43b), since there is no c-command between the two, and thus no possible Condition C violation. The speakers that I worked with did not accept co-referential readings here, but it’s possible that they would be accepted with enough contextual support; further research is needed to determine whether this is the case. Regardless of whether co-reference is possible, the examples in (43) still provide evidence against covert object inversion.

- b. This restriction can be obviated if:
 - i. *-(C)ia/ina* appears on the verb (without detransitivizing the clause), or
 - ii. The object is an incorporated bare noun that fronts with the predicate.
- c. *-(C)ia/ina* also appears in passives and transitive non-finite clauses.
- d. Subjects occupy a higher structural position than objects throughout the derivation.

6.3 Case discrimination as composite probing

I propose that syntactic ergativity in Nukuoro is derived via case discriminating \bar{A} -movement, building on previous case discrimination approaches developed by Otsuka (2006, 2010a), Legate (2008a), and Deal (2016b, 2017b). \bar{A} -movement is standardly assumed to target the closest element that carries the relevant \bar{A} -feature, following the principle of Relativized Minimality (Rizzi 1990); in Nukuoro, however, I argue that the \bar{A} -movement operation may only target \bar{A} -elements with particular case values, preventing the extraction of ergative arguments. Specifically, I argue that the probe responsible for \bar{A} -movement is a composite probe (e.g., Coon & Bale 2014; Colley & Privoznov 2020), which searches for two different features on the same goal: an $[\bar{A}]$ feature and an $[\text{ABS}]$ feature. As a result, \bar{A} -movement is restricted to absolutive arguments in Nukuoro: I will show that \bar{A} -movement is impossible for both ergative arguments and oblique arguments.

The idea that the Agree operation may reference Case is not a new one; for instance, it is well-known that phi-agreement may be sensitive to a nominal's case value (Bhatt 2005; Bobaljik 2008), and previous authors have applied Case-sensitive operations to account for extraction restrictions as well (Otsuka 2006; Legate 2008a; Deal 2016b, 2017b; Collins & Schuelke 2020). In previous accounts of syntactic ergativity, Case-sensitivity has been implemented via ad-hoc mechanisms, such as a “matching” operation between C and the goal (Otsuka 2006) or a “bundling” operation of \bar{A} and Case features (Legate 2008a), and others have simply stated an overarching accessibility requirement for \bar{A} -goals (Deal 2016b, 2017b; Collins & Schuelke 2020). Here, I aim to implement this accessibility requirement using existing theoretical machinery, namely the articulation of the mechanism of Agree. In this way, \bar{A} -movement that shows a syntactically ergative pattern can be viewed as a type of mixed A/\bar{A} -movement (e.g., van Urk 2015; Bossi & Diercks 2019; Colley & Privoznov 2020), an insight that factors into a number of existing analyses of syntactic ergativity (Aldridge 2004, 2008; Coon et al. 2021; Branen & Erlewine 2022). While inversion accounts suggest that syntactically ergative \bar{A} -movement is sensitive to $[\text{D}]$ features, such that intervening nominals prevent the extraction of ergatives, I make the narrower claim that such movement is sensitive to specific Case features on nominals.

6.3.1 Clause structural assumptions

The analysis that I present here relies on a number of assumptions about Nukuoro clause structure and Case assignment, which I develop in Chapters 4 and 7, respectively. I restate necessary details of these assumptions here.

As developed in Chapter 4, I assume that Nukuoro SVO clauses are derived via three steps of movement. First, the object undergoes A-movement to Spec,vP; second, the remnant VP undergoes predicate fronting to the specifier of a functional projection F, which lies just below Infl; and third, the subject undergoes A-movement to Spec,CP. The derivation of a Nukuoro clause is schematized in (45). In VSO clauses, I assume that the CP₁ does not carry a probe and subject movement does not occur (as discussed in §4.3.3 of Chapter 4); as a result, the subject surfaces in its base position in Spec,vP.

(45) Derivation of a Nukuoro SVO clause

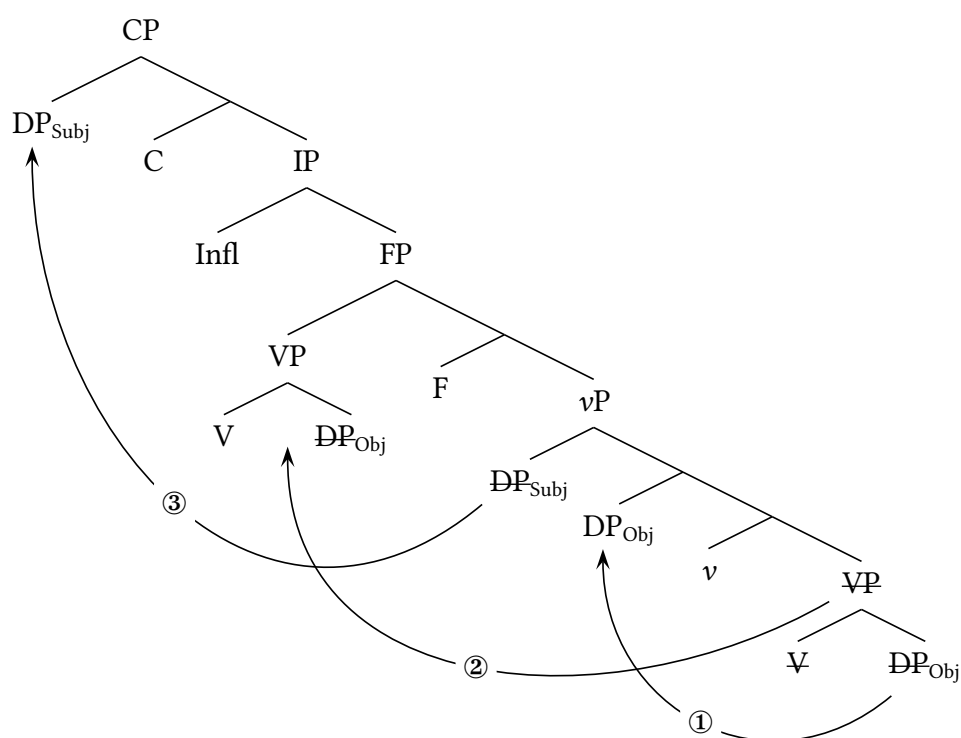

Ergative extraction restrictions arise in relativization contexts, which include relative clauses, *wh*-questions, and focus constructions. As argued in Chapter 5, I assume that genitive subjects of relative clauses occupy the same position as matrix subjects, namely Spec,CP. The C head responsible for relativization carries two probes, a phi probe and an \bar{A} -probe, which first moves the highest nominal to its specifier, and then moves the relativized argument to an outer specifier (46). Genitive case is then assigned by the higher n^0 to the pre-verbal subject, which is high enough to escape the CP phase; all other arguments, including post-verbal subjects and objects, are inaccessible for genitive assignment because they are contained within the CP phase.⁹

⁹Note that despite being structurally closest to the probe, the relative head itself cannot receive genitive case. As I mention in Chapter 5, this inability to receive Case is a property of \bar{A} -moved elements more broadly (e.g., Chomsky 1981; Safir 2019), and may suggest that \bar{A} -elements are encased in some kind of functional “shell” (Cable 2010; Safir 2019).

(46) Object relative clause structure in Nukuoro

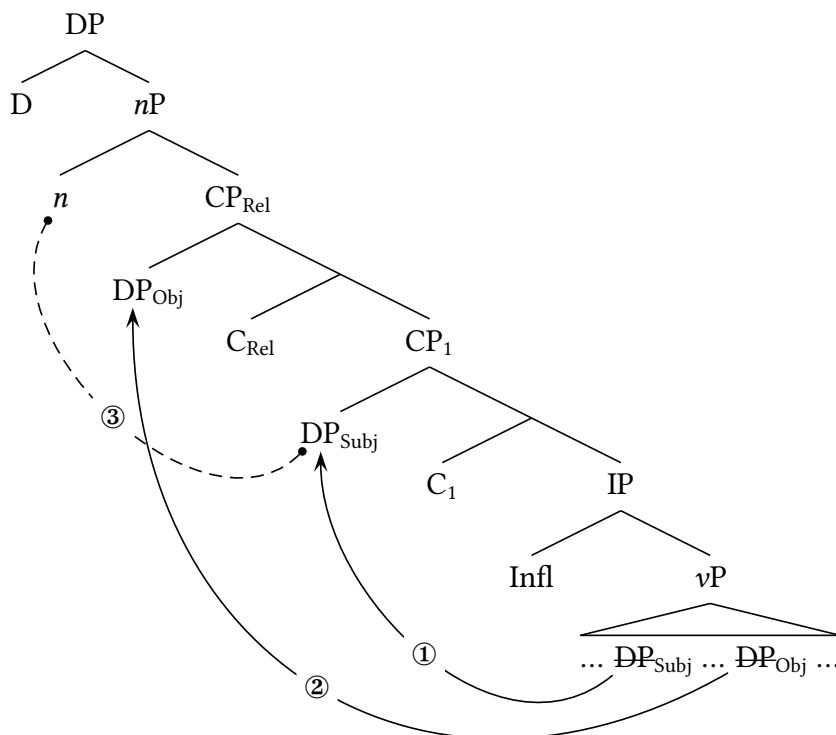

The crucial takeaway from the structure in (46) is that genitive marking on the subject does not affect relativization in any way: at the point of relativization, the subject has not yet received genitive Case from n^0 .

Finally, while Nukuoro does not show morphological ergative or absolutive case, I argue in Chapter 7 that the language is sensitive to abstract Case distinctions. This proposal aligns with the literature on ergative extraction restrictions, where analyses overwhelmingly rely on abstract ergative Case and its assignment to derive such restrictions.¹⁰ Specifically, I provide evidence that ergative Case in Nukuoro is assigned by Infl, while absolutive Case is assigned by v (e.g., Levin & Massam 1985; Bobaljik 1993; Laka 1993; Rezac et al. 2014); I assume that the same Agree relationship between v and the object underlies both absolutive Case assignment and movement to the inner specifier of vP . Case assignment in a transitive clause is schematized in (47).

¹⁰One notable exception is Erlewine (2016), who argues that ergative extraction restrictions arise as a result of the position of the transitive subject, not its Case value. I argue in §6.4 that Erlewine's (2016) anti-locality analysis cannot be adopted for Nukuoro.

(47) Structural ergative and absolutive Case assignment in Nukuoro

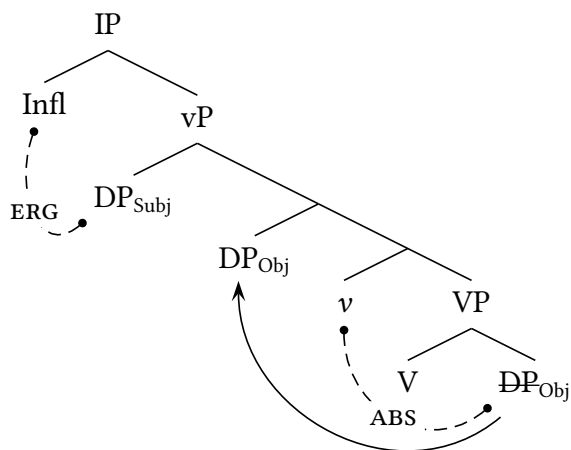

However, it is important to note that for the purposes of case discrimination, the exact mechanism of ergative Case assignment is irrelevant: any system which assigns ergative and absolutive Case prior to \bar{A} -movement will allow those Cases to be referenced by a case-discriminating composite probe.

6.3.2 Composite probing for $[\bar{A}]$ and $[ABS]$

I argue that the relative C head in Nukuoro carries a composite probe, which is articulated to halt when it encounters a goal that carries both an \bar{A} feature and an absolutive Case feature. The satisfaction condition for the probe on C_{Rel} is specified in (48).¹¹

- (48) Nukuoro \bar{A} -probe
 C_{Rel} : $[SAT: \bar{A}+ABS]$

The ergative extraction restriction allows unmarked \bar{A} -movement of absolutive arguments, but prevents the same movement for ergatives. This pattern is captured by articulating the probe on C to seek an $[\bar{A}]$ feature and an $[ABS]$ feature on the same element, allowing Agree to succeed only for absolutive arguments. Consider, for example, relativization of a transitive object DP, as schematized in (49).¹² Upon merge of the relative C head, the composite probe on C searches its c-command domain and considers the transitive subject first, which has neither of the features that will satisfy the probe; the probe then considers the transitive object, which carries an $[\bar{A}]$ feature as well as an $[ABS]$ Case feature. These two features together satisfy the probe, resulting in successful \bar{A} -movement of the transitive object.

¹¹In an Interaction-Satisfaction model of Agree (Deal 2015a, To appear), probes are also specified for the features they interact with (i.e., copy back to the probe). For the purposes of this analysis, however, it is not apparent or particularly relevant what the interaction condition of the probe on C_{Rel} is, since no features of the goal are ever realized on C. For concreteness, we can assume that the interaction condition is empty; only the satisfaction condition is relevant here because satisfaction of the probe results in movement.

¹²Throughout this section, I do not represent VP-fronting in schematic trees for readability.

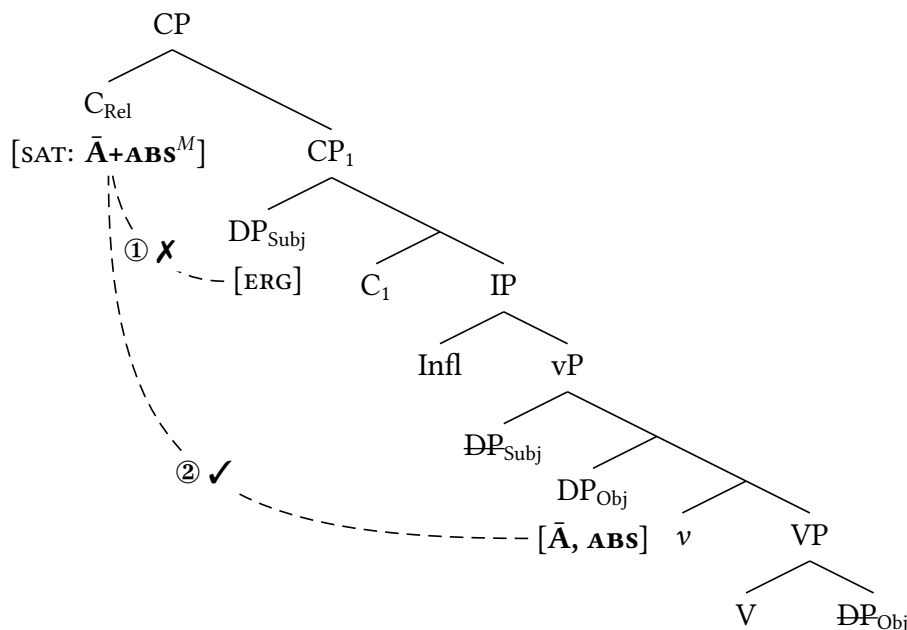
(49) Successful \bar{A} -movement of absolutive argument

The same facts hold of a relativized intransitive subject, which carries both an $[\bar{A}]$ and an $[ABS]$ feature. The probe on C_{Rel} will find both of these features on a single argument, thus satisfying the probe and moving the intransitive subject to Spec, CP.

What happens when an ergative subject carries an $[\bar{A}]$ feature, as in (50)? When the relative C head is introduced, its probe will again consider with the transitive subject first, which carries an $[\bar{A}]$ feature but no $[ABS]$ feature. Crucially, the $[\bar{A}]$ feature alone is not sufficient to satisfy the probe, which will halt only upon finding *both* $[\bar{A}]$ and $[ABS]$ on the same goal. As a result, the probe continues to search and finds the transitive object, which carries an $[ABS]$ feature but no $[\bar{A}]$ feature. Having found no element which carries both features, the probe does not Agree and fails to move anything, meaning that no relative clause is created. In other words, the string in (50) simply cannot be derived, resulting in a restriction on ergative extraction.¹³

- (50) * Go ai ne dau de beebaa laa?
 COP.FOC who PFV read DET book DIST
 Intended: 'Who read that book?'

(JR-20230504)

¹³ Assuming that Agree may fail (Béjar & Rezac 2003; Preminger 2014), the ungrammaticality of ergative extraction does not result from a derivational crash, but rather the inability to generate the intended string. The structure in (51) is able to be generated, but it cannot create the intended ergative \bar{A} -dependency.

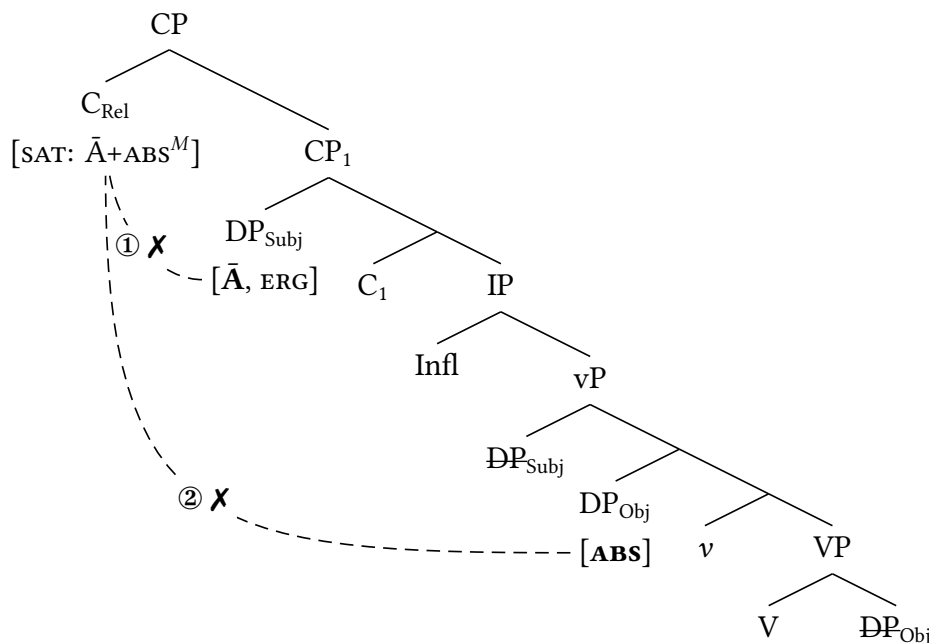
(51) Unsuccessful \bar{A} -movement of ergative subject

Note that in the derivations above, I assume that the satisfaction condition must be met on a single goal, or not at all; in other words, the $[\bar{A}]$ feature on its own cannot “partially satisfy” the probe.¹⁴ In Scott’s (2021) terms, the probe I propose for a syntactically ergative language is *conjunctively* satisfied, requiring both features to appear on the same goal.

The formalization of case discrimination as composite probing for $[\bar{A}]$ and $[ABS]$ characterizes syntactic ergativity as ‘absolute-only’ agreement. This implementation rules out \bar{A} -movement for any non-absolute argument: not just ergatives, but also adjuncts and prepositional phrases. In other words, we predict that all oblique arguments should be banned from participating in \bar{A} -movement as well. This prediction is borne out in Nukuoro: all non-core arguments are introduced by prepositional structure and cannot be relativized using an unmarked strategy. Instead, all oblique arguments involved in \bar{A} -dependencies, including high and low adjuncts (52a-b), instruments (52c), and goals (52d), require the oblique anaphor *ai* to appear in their base position.

- (52) a. Go anaahi aana ne gaavange *(**ai**) dahi beebaa gi a Ruth.
 COP.FOC yesterday 3SG.GEN.A PFV give OBL one book to PN Ruth
 ‘It was yesterday that he gave a book to Ruth.’ (JR-20190605)
- b. Go hee a Soni ne maga ange *(**ai**) de buu?
 COP.FOC where GEN.A Soni PFV throw DIR.DIST OBL DET ball
 ‘Where did Johnny throw the ball (to)?’ (JR-20220704)

¹⁴Specifically, I do not adopt a feature gluttony approach (Coon & Keine 2021; Coon et al. 2021), where an illicit configuration arises when the probe interacts with—and finds one relevant feature on—two distinct goals.

- c. Se aha aana ne tuu *(**ai**) de huaamee?
 COP.SG what 3SG.GEN.A PFV cut OBL DET coconut
 ‘What did he cut the coconut with?’ (JR-20220704)
- d. Go ai a Soni e gaav-ange *(**ai**) de beebaa?
 COP.FOC who GEN.A Soni IPFV give-DIST.DIR OBL DET book
 ‘Who will Johnny give the book to?’ (JR-20220704)

I propose that *ai* is base-generated within the VP and syntactically bound by the fronted argument; in other words, *ai* is not the result of movement, and appears because true movement of obliques is impossible. Evidence that *ai* does not realize the lower copy of a movement chain comes from idiom reconstruction, which shows an asymmetry between an \bar{A} -dependency that leaves a gap (i.e., absolutive movement) and an \bar{A} -dependency that leaves a resumptive anaphor (i.e., oblique movement). \bar{A} -dependencies with absolutive arguments allow idiomatic interpretations to be retained. For example, the idiom *vava de ngudu* (lit. ‘one’s mouth leaks’) has the idiomatic meaning ‘to be chatty’ (53a); this idiomatic meaning is maintained even when the absolutive subject of the idiom is focused.

- (53) a. E vava de ngudu o Ruth.
 IPFV leak DET mouth GEN.O Ruth
 ‘Ruth is chatty.’ (lit. ‘Ruth’s mouth leaks.’)
- b. Go de ngudu o Ruth_i nogo vava ____i laa.
 COP.FOC DET mouth GEN.O Ruth IPFV leak DIST
 ‘It’s Ruth who was chatty.’ (lit. ‘It’s Ruth’s mouth that was leaking.’) (JR-20221006)

Assuming that idiomatic interpretations require all subparts of an idiom to be base-generated as a constituent (e.g., Chomsky 1993), this behavior suggests that absolutive \bar{A} -dependencies involve constituent movement.

By contrast, idioms that are formed with obliques do not retain their idiomatic readings when the oblique argument is an \bar{A} -element. The idiom *hulo gi lunga ma lalo* (lit. ‘to go up and down’) has the idiomatic meaning ‘to argue’ (54a); however, when the prepositional phrase *gi lunga ma lalo* is focused and the anaphor *ai* is used, only the literal meaning remains (54b).

- (54) a. Gimaau ne hulo **gi lunga ma lalo**.
 1DU.EXCL PFV go to above and below
 ‘We argued.’ (lit. ‘We went up and down.’)
- b. *Go lunga ma lalo omaau ne hulo **ai**.
 COP.FOC above and below 1DU.EXCL.GEN.O PFV go.PL OBL
 ‘It’s up and down that we went.’
 *‘We argued.’ (JR-20200511)

The inability of oblique arguments to undergo true \bar{A} -movement in Nukuoro is consistent with the characterization of \bar{A} -movement as being restricted to absolutive arguments.

6.3.3 Repairs and other functions of *-(C)ia/ina*

Recall that transitive subject extraction in Nukuoro succeeds in two contexts: (i) when the verb appears with *-(C)ia/ina* morphology; and (ii) when the object is incorporated. I argue that both of these contexts allow exceptional absolutive Case assignment to the transitive subject, which then allows the transitive subject to be a licit goal for composite \bar{A} -movement.

I propose that *-(C)ia/ina* realizes the head of an additional *vP* layer, which I label v_{INA} , which assigns an additional instance of absolutive Case.¹⁵ In ergative extraction contexts, I propose that v_{INA} appears as a type of ‘last resort’ strategy (e.g., Ordóñez 1995; Coon et al. 2014; Assmann et al. 2015; Rezac 2011), assigning absolutive Case to the transitive subject to allow transitive subject extraction, as shown in (55).¹⁶

(55) Case assignment in transitive clauses with *-(C)ia/ina*

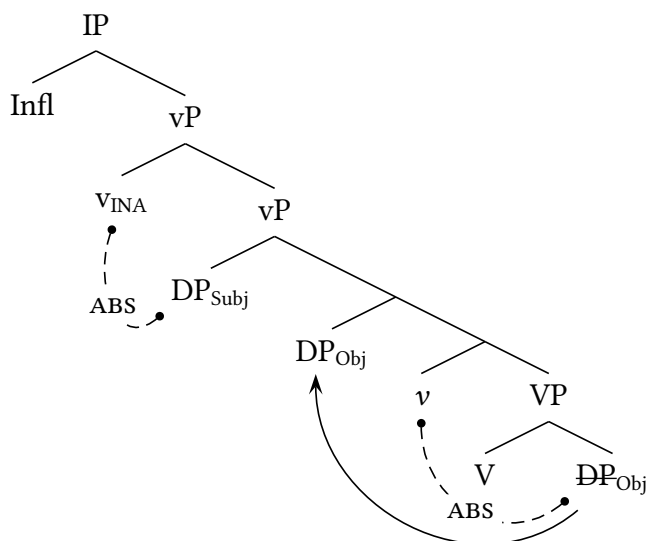

Since the transitive subject has been assigned absolutive Case, it now has both of the features required to satisfy the composite $[\bar{A}+\text{ABS}]$ probe on C_{Rel} . As a result, when *-(C)ia/ina* is present, transitive subjects are eligible for \bar{A} -movement.

This analysis of *-(C)ia/ina* has precedent in the broader Polynesian literature, while also capturing the idiosyncratic uses of *-(C)ia/ina* in Nukuoro. While the function of **-Cia* differs across Polynesian languages, it is well-accepted to have a function related to transitivity and voice (Chung 1978; Pawley 2001). As a result, **-Cia* is typically placed in the *v*/Voice domain (e.g., Tollan 2018), consistent with the analysis I propose here. Furthermore, as I argue in Chapter 7, the interpretation of *-(C)ia/ina* as an additional Case licenser explains its presence in subjunctive

¹⁵The exact characterization of this head is not crucial for the analysis: *-(C)ia/ina* could realize *v*, Voice, or an auxiliary verb. It is only necessary that the head realized by *-(C)ia/ina* assigns absolutive to the transitive subject.

¹⁶In addition to receiving an $[\text{ABS}]$ feature from v_{INA} , the transitive subject may also receive an $[\text{ERG}]$ feature as well. In Chapter 7, I develop a theory of Case assignment where nominals can receive two Case values, one corresponding to $[\text{ABS}]$ and one corresponding to $[\text{ERG}]$.

and imperative clauses in Nukuoro, where the ergative subject otherwise lacks licensing due to the absence of Infl.¹⁷ In these clauses, *-(C)ia/ina* appears to license the transitive subject.

Interestingly, this function can also account for the appearance of *-(C)ia/ina* in passive constructions, where the external argument has been demoted to an oblique. In this function, I propose that *-(C)ia/ina* serves to license the *internal* argument. I suggest that the Nukuoro passive is a flavor of *v*, namely v_{PASS} , which introduces an optional PP agent in its specifier, but carries no agreement probe and does not assign a Case value. In other words, v_{PASS} results in a configuration where the DP internal argument remains within the VP and fails to receive Case, resulting in a licensing failure (56).

(56) Nukuoro passive without *-(C)ia/ina*

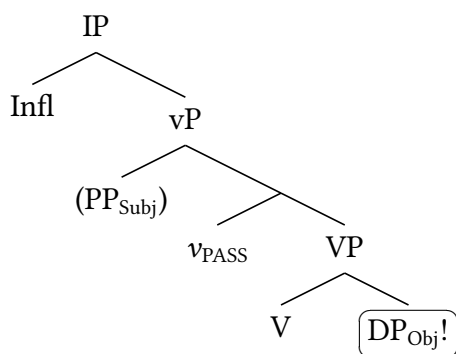

The derivation only converges if v_{INA} is present to Agree with the object and assign it absolutive Case, satisfying the Case Filter (57). v_{INA} also moves the object to its specifier, allowing it to vacate the VP before it fronts.¹⁸

¹⁷This analysis predicts that transitive subjects of non-finite clauses should be able to extract, since they receive [ABS] from v_{INA} . Unfortunately, it is not possible to test this prediction because the indication of marked subject extraction is itself *-(C)ia/ina*, which appears in transitive non-finite clauses independent of extraction.

¹⁸ If v_{INA} triggers movement, it would presumably also trigger movement of the subject in ergative extraction clauses. This movement would be vacuous, and does not affect any of the proposals made here.

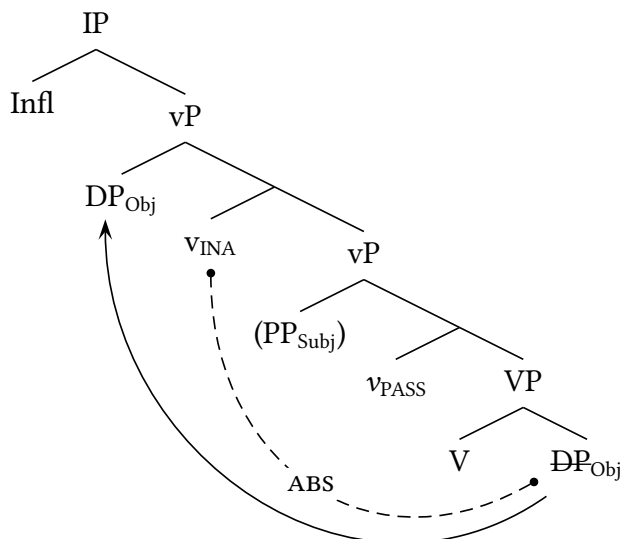
(57) Nukuoro passive with *-(C)ia/ina*

The analysis of *-(C)ia/ina* as a last-resort absolutive Case licenser allows us to understand why it seems to license the transitive subject in non-finite clauses, but the transitive object in passives.

In addition to *-(C)ia/ina*, the ergative extraction restriction can be obviated by incorporating the transitive object, a strategy which crops up in other syntactically ergative languages, such as K'iche' (Coon et al. 2021). In Nukuoro, bare noun objects may incorporate into the verbal head, remaining within the VP as it fronts and allowing unmarked subject extraction. I suggest that incorporated bare noun objects are contained within a complex verbal head, and thus are not visible for absolutive Case assignment. Without an object to agree with, the *v* probe then reprojects and Agrees with the external argument in its specifier, which receives absolutive Case. The transitive subject is thus an eligible target for \bar{A} -movement by relative C. This configuration is schematized in (58).

(58) Case assignment in the context of an incorporated object

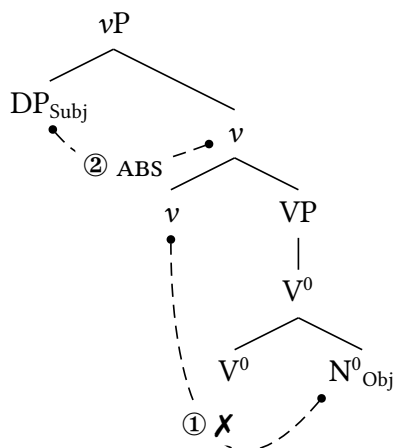

Along similar lines, we predict that object incorporation should affect the appearance of *-(C)ia/ina* in transitive non-finite clauses. A typical transitive non-finite clause is provided in (59a), where *-(C)ia/ina* is obligatory. However, if the object of a subjunctive clause is incorporated, the current analysis predicts that *-(C)ia/ina* will not appear because *v* will reproject and agree with the transitive subject, assigning it absolutive Case and satisfying the Case Filter without the need for an additional licenser.¹⁹ This prediction is borne out, as shown in (59b).

- (59) a. Au e lodo Ruth gi [llaanga *(ina)] denga gede ailaanei.
 1SG IPFV want Ruth SBJV weave.CIA INA DET.PL basket today.FUT
 ‘I want Ruth to weave the baskets today.’ (JR-20220727)
- b. Au e lodo Ruth gi [llanga gede] ailaanei.
 1SG IPFV want COMP Ruth SBJV weave basket today.FUT
 ‘I want Ruth to weave baskets today.’ (JR-20220727)

Obviation strategies like antipassivization or object incorporation are often used as key evidence in support of an object inversion analysis of syntactic ergativity (e.g., Coon et al. 2021), given that ergative extraction appears to be sensitive to the position of the transitive object. On the present view, however, this apparent sensitivity to object position is an epiphenomenon: ergative extraction is actually sensitive to the Case value of the *subject*, which may change if the object is not a licit target for Agree and Case assignment. In this way, the Case assignment mechanism proposed here could be seen as a structural implementation of dependent Case (e.g., Marantz 1991; Baker 2015), which allows object Case assignment to affect further Case assignment to the subject. The object remains in its base position only in circumstances where it does not require licensing, or has been licensed through non-Case mechanisms, such as verbal adjacency (Baker 2014; Levin 2015); in such cases where the object is not a target for licensing, *v* is able to Agree with and license the external argument.

6.3.4 Comparison with inversion accounts

Compared with object inversion accounts, the case discrimination mechanism requires fewer moving parts: syntactic ergativity can be attributed to a single probe specification, and thus is not tied to one particular clause structural configuration or case assignment mechanism. This is the primary strength of the case discrimination account, given the amount of cross-linguistic variation among ergative languages.

¹⁹It is possible to add *-(C)ia/ina* when there is a bare noun object:

- (i) Au e lodo Ruth gi llaanga ina gede ailaanei.
 1SG IPFV want Ruth SBJV weave.CIA INA basket today.FUT
 ‘I want Ruth to weave the baskets today.’ (JR-20220727)

However, since bare noun objects may optionally undergo object shift (see Chapter 4), it is difficult to tell whether *-(C)ia/ina* may freely appear in an incorporation structure, or if it is obligatory in cases where the bare noun has shifted and impossible where the bare noun is incorporated.

For instance, case discrimination can account for ergative extraction restrictions in languages with and without evidence of object inversion, as long as they assign ergative and absolutive Case. On the present view, inversion of the object is only related to extraction behavior insofar as it relates to ergative and absolutive Case assignment. Since many inversion-based analyses attribute object inversion to absolutive Case assignment from Infl (Campana 1992; Bittner & Hale 1996a; Coon et al. 2014; Clemens & Tollan 2021; Coon et al. 2021), it is very straightforward to extend the current analysis to languages with inversion. In fact, a case discrimination analysis can derive syntactic ergativity on any syntactic theory of Case assignment: only the resulting Case values are relevant to the \bar{A} -extraction restriction, so the exact mechanism of Case assignment can vary from language to language. Inversion-based analyses, by contrast, cannot account for languages like Nukuoro, where subjects remain higher than objects throughout the derivation.

Case discrimination accounts also succeed in capturing languages where only a subset of \bar{A} -movement types show syntactic ergativity, since the restriction is built into the structure of the \bar{A} -probe. Polinsky (2016) shows that in Chukchi (Chukotko-Kamchatkan), relativization shows an ergative extraction restriction, while *wh*-movement can freely apply to ergatives (60).

- (60) a. Mikəne milger kun-nin?
 who.ERG gun.ABS buy-AOR.3SG.SUBJ.3SG.OBJ
 ‘Who bought a/the gun?’
- b. * [milger kənnə-lʔ-ən] ənpənaçg-ən
 gun.ABS buy-PTCP-ABS old.man-ABS
 Intended: ‘the old man who bought the gun’ (Polinsky 2017b:7)

Since both of these clause types are fully finite, both would ostensibly involve object inversion—yet only one clause type shows an extraction restriction. If ergative extraction restrictions are attributed to probe specifications, however, there is a natural explanation for clause splits like those in Chukchi, as Deal (2017b) notes: the probes responsible for relativization and *wh*-movement simply have different properties. On the current analysis, the probe responsible for relativization is a composite probe, searching for both [\bar{A}] and absolutive Case features, while the *wh*-probe only searches for [\bar{A}] features.

6.4 Against alternative accounts

While the previous section developed a case discrimination account of Nukuoro, there are two other existing analyses which derive ergative extraction restrictions without inversion: namely, the prepositional ergative account (Polinsky 2016) and the anti-locality account (Erlewine 2016). In this section, I show that both of these accounts miss key generalizations about the Nukuoro ergative extraction restriction.

Polinsky (2016) proposes that in syntactically ergative languages, ergative Case is prepositional: the ergative argument is introduced in a PP, where the overt or null P head assigns ergative Case to its complement. Restrictions on ergative extraction can be reduced to dual restrictions on stranding and pied-piping of prepositions: if the ergative preposition cannot be stranded or

pied-piped, the ergative argument cannot extract. In Nukuoro, the preposition that introduces the ergative argument would be null; *-(C)ia/ina* would perhaps alleviate the restriction by introducing or licensing the ergative subject as a DP, rather than a PP.

At first glance, this account seems applicable to Nukuoro: the prepositions *i* and *gi*, which introduce most oblique arguments, cannot be stranded (61a) and typically do not undergo pied-piping (61b). However, Nukuoro has a productive resumption strategy to resolve these restrictions. All prepositional elements under \bar{A} -extraction must be resumed by the oblique anaphor *ai*, which appears in the post-verbal position (61c).

- (61) a. *Go ai a Soni ne dau ange **gi**?
 COP.FOC who GEN.A Johnny PFV collide DIR.DIST OBL to
 Intended: ‘Who did Johnny run into?’ (JR-20230427)
- b. ***Gi hee** olaadeu e hulo nei?
 to where 3SG.GEN.O IPFV go.PL OBL PROX
 Intended: ‘Where are they going?’ (JR-20200527)
- c. Go ai a Soni ne dau ange **ai**?
 COP.FOC who GEN.A Johnny PFV collide DIR.DIST OBL
 ‘Who did Johnny run into?’ (JR-20230427)

Resumption with *ai* must also be used for objects of middle constructions under \bar{A} -extraction (62), showing that *ai* can even resume an oblique argument which is selected for and thematically licensed by the verb.

- (62) a. De biliisimani gu daudali ange gi taane laa.
 DET police INC follow DIR.DIST to DET.man DIST
 ‘The police followed that man.’ (ML-20210709)
- b. Go ai o de biliisimani ne daudali ange *(ai)?
 COP.FOC who GEN.O DET police PFV follow DIR.DIST OBL
 ‘Who did the police follow?’ (ML-20210709)

If the ergative extraction restriction were reduced to independent stranding and pied-piping restrictions in the language, we would expect that the language would recruit existing machinery to obviate these restrictions: namely, resumption with the anaphor *ai*. This is not possible: \bar{A} -extracted ergative arguments cannot be resumed by *ai* (63a), and in fact, cannot be resumed by any anaphor, whether that anaphor appears in preverbal or postverbal position (63b).

- (63) a. *tangada ne maga **ai** de buu
 DET.person PFV throw OBL DET ball
 Intended: ‘the person who threw the ball’ (JR-20230504)
- b. *Go ai **aana** ne gidee laa Soni?
 COP.FOC who 3SG.GEN.A PFV see DIST Johnny
 Intended: ‘Who saw Johnny?’ (ML-20210917)

- c. *Go ai ne gidee laa **ia** Soni?
 COP.FOC who PFV see DIST 3SG Johnny
 Intended: ‘Who saw Johnny?’ (JR-20230906)

The fact that *-(C)ia/ina* is used to repair ergative extraction contexts, rather than the canonical repair for stranding/pied-piping restrictions, suggests that the problem with extracting ergatives should not be attributed to prepositional structure.

Alternatively, one could argue that the Nukuoro extraction restriction has nothing to do with abstract Case, but rather can be attributed to an anti-locality condition on subject extraction (Erlewine 2016). On this view, transitive subjects obligatorily occupy a position higher than intransitive subjects, which is too close to the landing site of \bar{A} -movement. If this analysis were tenable for Nukuoro, claims about abstract Case in the language would be significantly weakened.

This analysis also does not get much traction in Nukuoro, as it makes incorrect predictions regarding word order.²⁰ A key prediction of the anti-locality account is that ergative extraction should be possible if the subject can move directly from its base position in Spec, ν P. On the assumption that post-verbal subjects remain in their base position, we predict that extraction should be possible for any subject argument that can remain post-verbal. This prediction is not borne out in Nukuoro: word order flexibility for subjects has no effect on the extraction restriction. The availability of post-verbal subjects in relative clauses varies across speakers and constructions; consider the judgements of one speaker, who allows post-verbal subjects in intransitive clauses (64a) but not in middles (64b) or transitives (64c).

- (64) a. Gu kada **denga gauligi**.
 INC laugh DET.PL child
 ‘The children laughed.’ (JR-RR-20190624)
- b. *E aloha **denga gauligi** i de gaaduu.
 IPFV love DET.PL child PREP DET dog
 Intended: ‘The children love the dog.’ (JR-RR-20190624)
- c. *Ne llanga **goe** denga gede.
 PFV weave DET.PL child DET.PL basket
 Intended: ‘The children wove the baskets.’ (JR-20220627)

The anti-locality account predicts that since a post-verbal position is not available for middle or transitive subjects, these subjects should show a restriction on extraction. This is not the case: subjects of middles may freely \bar{A} -extract without the use of *-(C)ia/ina* (65b), while transitive subjects are barred from undergoing \bar{A} -movement (65c).

²⁰Another of Erlewine’s (2016) core pieces of evidence for anti-locality in Kaqchikel comes from the placement of adverbs: placing a high adverb between the subject and the complementizer appears to obviate the ergative extraction restriction. Unfortunately, this diagnostic is not testable in Nukuoro, because there are no known adverbs which intervene between pre-verbal subjects and the landing site of \bar{A} -movement. As I argued in Chapter 4, pre-verbal subjects occupy a relatively high position in Spec,CP₁. I know of no adverbs in the language which attach to a position higher than that: meanings that are communicated using CP-level adverbs in other languages (e.g., *definitely*, *luckily*) are matrix embedding predicates in Nukuoro.

- (65) a. Go ai e aloha (*ina) i de gaaduu?
 COP.FOC who IPFV love INA PREP DET dog
 Intended: ‘Who loves the dog?’ (JR-20190607)
- b. Go koe ne llaanga ina de gede anaahi.
 COP.FOC 2SG PFV weave.CIA INA DET.PL basket yesterday
 ‘It’s you who wove the baskets yesterday.’ (JR-20220627)

A similar argument can be made for the word order patterns of a different speaker, who allows post-verbal transitive subjects in some relative clauses but not others (66).

- (66) a. de masoaa [ne saabai ai **de gauligi** de gede]
 DET time PFV carry OBL DET child DET basket
 ‘the time that the child carried the basket’ (ML-20210917)
- b. *de masoaa [ne hagaili ai **de gauligi** Soni]
 DET time PFV hit OBL DET child Johnny
 ‘the time that the child hit Johnny’ (ML-20210917)

Based on these judgements, we predict that extraction of the transitive subject should be possible in (66a), where post-verbal subjects are licit for this speaker, but not in (66b). However, the transitive subject is unable to extract in either construction, as indicated by the presence of *-(C)ia/ina* morphology (67).

- (67) a. Go de gauligi ne **saabai ina** de gede.
 COP.FOC DET child PFV carry INA DET basket
 ‘It’s the child who carried the basket.’ (ML-20210917)
- b. Go de gauligi laa ne hagaili-**a (ina)** Soni.
 COP.FOC DET child DIST PFV hit-CIA INA Johnny
 ‘It’s the child who hit Johnny.’ (ML-20210917)

I conclude that the extraction restriction is not sensitive to a lower position for the subject, but rather to transitivity: only transitive subjects fail to \bar{A} -extract, which I attribute to the presence of abstract ergative Case.

6.5 Conclusions

This chapter provides a novel implementation of case discrimination as composite probing, re-framing a long-held insight that syntactic ergativity arises due to case requirements of the heads that drive \bar{A} -movement (Otsuka 2006, 2010a; Legate 2008a; Deal 2017b; Collins & Schuelke 2020). On the view developed here, ergative extraction restrictions arise as a result of a composite probe on C, which seeks an [\bar{A}] feature and an absolutive Case feature on the same goal. Ergative arguments are thus prevented from entering into \bar{A} -movement dependencies. This restriction is obviated by creating a structure where the transitive subject is assigned absolutive, either by adding

an additional absolutive Case licenser, like v_{INA} , or by incorporating the object and removing it from the Case calculation.

The composite probe account follows naturally from two distinct literatures on Agree. The first strand of literature argues that Agree relations can be sensitive to case, as evidenced by phenomena such as case-sensitive phi-agreement (e.g., Bhatt 2005; Bobaljik 2008) and case-sensitive switch reference (e.g., Clem 2019). With \bar{A} -dependencies carried out by Agree, the fact that these can be case-sensitive as well is unsurprising. A second strand of literature shows that probes can be sensitive to more than one feature at the same time (e.g., Coon & Bale 2014), including features that cross the A/\bar{A} divide (e.g., van Urk 2015; Bossi & Diercks 2019; Colley & Privoznov 2020; Erlewine 2018; Coon & Keine 2021). Case discrimination in \bar{A} -movement is another example of mixed A/\bar{A} -movement, which goes beyond sensitivity to phi-features or [D] and involves more specific features of nominals, namely Case features.

In addition to this theoretical contribution, this paper provides novel description of an ergative extraction restriction in Nukuoro, an understudied Polynesian Outlier language. From an empirical standpoint, Nukuoro is an important case study because it demonstrably lacks object inversion, unlike many well-studied syntactically-ergative languages in the Inuit and Mayan language families (e.g., Bittner & Hale 1996a; Coon et al. 2014, 2021). Furthermore, Nukuoro lacks morphological case, which violates the widely-held generalization that syntactic ergativity only exists in the presence of morphological ergativity (Dixon 1994). However, I argue that Nukuoro assigns abstract ergative and absolutive Case in the syntax. Contra previous case-discrimination approaches, the Nukuoro pattern shows that \bar{A} -movement must be able to reference syntactic Case features, rather than morphological case values (cf. Deal 2016b, 2017b).

A natural question arises concerning the typological predictions of a composite probe account. The formalization that I have presented here places no restrictions on which Case features may be present in the satisfaction condition of an \bar{A} -probe. Meanwhile, we know that extraction restrictions show relatively constrained behavior cross-linguistically: restrictions typically target marked cases (i.e., ergative and accusative) rather than unmarked cases (i.e., absolutive and nominative). Given that composite probes may be articulated in any number of ways, how do we prevent the current account from overgenerating?

I note first that case discrimination via composite probing is built upon independently motivated and pre-existing machinery, namely abstract Case features and the articulation of Agree to search for \bar{A} and nominal features simultaneously. The problem of overgeneration, then, falls on these two mechanisms: ruling out unattested instances of composite probing for Case requires us to constrain the assignment of Case features or the mechanism of Agree more broadly.

That being said, the fact that composite probing can derive different Case-based extraction restrictions may actually be a welcome consequence of this account. While ergative extraction restrictions are widely known and studied, there is a wide range of documented extraction restrictions cross-linguistically. Table 6.2 provides a number of possible composite probe specifications, along with a language that instantiates the predicted empirical pattern.

For instance, on the current view, it is possible to articulate a probe which searches for $[\bar{A}]$ and [ERG] on the same goal, effectively generating an *absolutive* extraction restriction. While this kind of restriction violates Keenan and Comrie's (1977) well-established case accessibility hierarchy,

Predicted pattern	Potential attested example
[SAT: \bar{A} +NOM]: only subjects may \bar{A} -move	Māori (Polynesian; Douglas 2018)
[SAT: \bar{A} +ACC]: only objects may \bar{A} -move	Kinande (Bantu; Schneider-Zioga 2007)
[SAT: \bar{A} +ERG]: only ergatives may \bar{A} -move	Roviana (Oceanic; Collins & Schuelke 2020)
[SAT: \bar{A} +OBL]: only obliques may \bar{A} -move	Tagalog (Austronesian; Aldridge 2002)

Table 6.2: Predicted vs. attested Case-based extraction restrictions

Collins & Schuelke (2020) describe exactly one such extraction restriction in Roviana (Oceanic; Solomon Islands), where ergative arguments—but not absolutive arguments—may participate in an unmarked fronting operation (68).²¹

- (68) a. **asa** tigisi=ia sa huneke
 3SG weave=3SG.OBJ ART hand.bag
 ‘S/he weaves the basket.’
- b. * **asa** puta
 3SG sleep
 ‘S/he slept.’
- c. * **sa siki** taka=ia Bili
 ART dog kick=3SG.OBJ Bill
 ‘Bill kicked the dog.’

(Collins & Schuelke 2020:5)

Restrictions of the Roviana type demonstrate that while languages follow general typological tendencies, behavior that runs against such tendencies is still attested in the world’s languages. As such, it is necessary for the syntactic mechanism to generate a wide variety of patterns, despite some patterns being more frequent than others.

²¹Interestingly, dative arguments may also undergo null fronting in Roviana, while oblique arguments cannot. To capture this behavior, Collins & Schuelke (2020) propose that rather than targeting Case features, unmarked fronting targets a broader set of features, which they call Grammatical Relations (GR) features, which group ergatives and datives to the exclusion of absolutes and obliques. It is possible to adopt this feature structure on the current proposal as well. If certain Case features pattern together cross-linguistically, it may also be possible to develop a hierarchical ontology of Case features, similar to ontologies that have been developed for person features (e.g., Harley & Ritter 2002).

Chapter 7

Abstract ergative Case assignment

A large body of work has been dedicated to understanding the connection between nominal form and nominal distribution, two properties which are subsumed under traditional Case Theory (Chomsky 1981). Case is first and foremost a morphological property: nominals appear in different forms depending on their grammatical role, a phenomenon known as morphological case. Beyond this observable property, it is traditionally assumed that nominals also possess abstract syntactic values, known as abstract Case, which serves to license nominal arguments and provide the basis for morphological case realization.¹

In recent years, the existence of abstract Case has come into question, particularly in the absence of overt case morphology. For instance, some have argued that abstract Case exists in some languages but not in others (Harford Perez 1985; Markman 2009; Diercks 2012), while other authors reject the existence of abstract Case altogether, reducing case to a purely morphological phenomenon (Marantz 1991; McFadden 2004; Landau 2006b; Bobaljik 2008). Despite these challenges, recent work has argued that abstract Case does, indeed, exist in languages that show no morphological case (van der Wal 2015; Sheehan & van der Wal 2016; Sheehan & van der Wal 2018; Halpert 2016). So far, these languages are all nominatively-aligned, however, raising the question of whether languages with fully covert Case systems show the same range of patterns as languages with morphological case.

The existence of abstract Case is particularly relevant for ergative languages, where Case is thought to account for a third property: participation in certain syntactic operations, such as \bar{A} -movement. Syntactic ergativity has long been attributed to abstract ergative and absolutive Case, either directly (e.g., Otsuka 2010a; Polinsky 2016; Deal 2017b) or as a by-product of the syntax through which Case is assigned (e.g., Campana 1992; Ordóñez 1995; Aldridge 2004, 2008; Bittner & Hale 1996a; Coon et al. 2014; Assmann et al. 2015). At the same time, it has been claimed that syntactically ergative behavior only appears in languages that show morphological ergativity (Dixon 1994). This generalization, which I will refer to as “Dixon’s generalization”, is mysterious from the point of view of Case Theory: if abstract ergative Case exists and is subject to general morphological principles which allow for the possibility of null realization (e.g., Legate 2008a),

¹Following standard convention, I use Case (capitalized) to refer to the syntactic phenomenon, and case (lowercase) to refer to the morphological phenomenon.

we expect to find a language that shows syntactic ergativity without morphological ergativity (as noted by, e.g., Polinsky 2017b:30). If no such language exists, Dixon's generalization calls abstract Case into question, implying instead that syntactic operations must instead be sensitive to morphological case distinctions directly.

In light of these debates, this chapter argues for the existence of abstract ergative Case without morphological case in Nukuoro. I demonstrate that core arguments do not show any morphological case marking and there is no verbal agreement, yielding a morphologically neutral alignment in the language. Despite lacking case morphology, non-finite clauses show an ergative licensing pattern: when finite Infl is absent, transitive subjects alone fail to be licensed. This ergative distribution in non-finite contexts appears alongside an ergative extraction restriction, which is attributable to abstract Case directly, as I argued in Chapter 6. In other words, a theory of Case in Nukuoro is responsible for capturing the distribution of nominals and their participation in syntactic operations, even though they lack the forms typically associated with case.

I propose that Nukuoro clause structure involves abstract ergative and absolutive Case licensing, which underlies the ergative extraction restriction and restricts the distribution of DPs in non-finite clauses. Specifically, I argue that Infl is the locus of ergative Case in Nukuoro, while *v* is the locus of absolutive Case. This proposal builds on a strand of literature which takes ergative to be a structural Case, assigned (at least in part) via Agree with Infl (Levin & Massam 1985; Bobaljik 1993; Laka 1993; Otsuka 2000, 2006; Deal 2010; Rezac et al. 2014; Clem 2019). Case assignment in Nukuoro transitive clauses is schematized in (1).

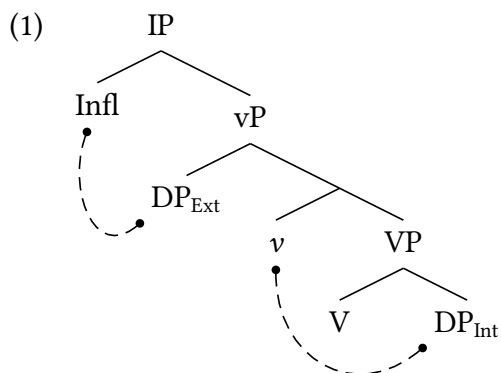

The present account differs from previous structural ergative proposals in the treatment of intransitive clauses. Accounts of ergative Case assignment typically impose a transitivity condition on the functional head that assigns ergative, restricting ergative assignment to transitive clauses and thus preventing intransitive subjects from receiving ergative Case (e.g., Levin & Massam 1985; Bobaljik 1993; Legate 2008b). Here, I present an alternative analysis where intransitive subjects enter into two Case dependencies, one with Infl and one with *v*. The Case assignment configuration for intransitive subjects is schematized in (2a).

(2) a. Unergative intransitive

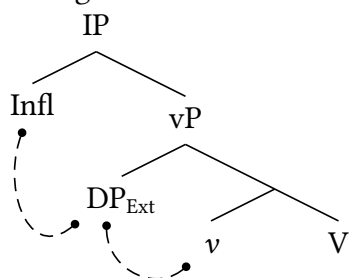

b. Unaccusative intransitive

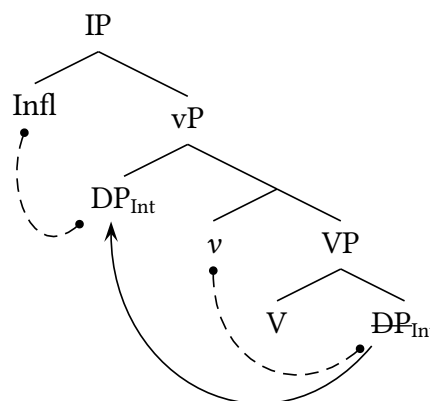

As I will show, the Case assignment mechanisms in (1) and (2a) suffice to capture the Case behavior of Nukuoro, which does not mark case distinctions in the morphology. In languages with overt morphological case, I propose that Case values on intransitive subjects can then undergo morphological *impoverishment* (Bonet 1991; Noyer 1992; Halle & Marantz 1993), where one of the two Case values is deleted post-syntactically; this impoverishment will yield either an ergative or accusative alignment, depending on which value is deleted. If the Case value from Infl is impoverished, the resulting alignment is ergative; if the Case value from *v* is deleted, the resulting alignment is accusative. For this reason, I will refer to this proposal as a *flexible intransitive* account, since intransitive subjects may flexibly pattern with transitive subjects or objects.

The treatment of ergative as a structural Case contrasts with other standard mechanisms of ergative Case assignment, including inherent and configurational analyses. Inherent approaches (e.g., Woolford 1997, 2006; Aldridge 2004; Anand & Nevins 2006; Legate 2004, 2008b, 2012; Mahajan 2012) typically take ergative to be assigned in its base position by the head that introduces it, while configurational approaches (e.g., Baker 2014, 2015; Baker & Bobaljik 2017; Ershova 2019; Yuan 2022) take ergative to be assigned when there is another eligible nominal in the same domain. I show that both of these approaches struggle to capture the ergative licensing pattern in Nukuoro non-finite clauses, as well as the connection between non-finite clauses and ergative extraction. Furthermore, I demonstrate that the flexible intransitive account not only captures the extraction and licensing behavior of Nukuoro, but also extends to a number of other well-known properties of case systems, including morphological and syntactic splits as well as phenomena related to multiple case assignment.

The chapter is laid out as follows: Section 7.1 provides an overview of morphological case and agreement phenomena in Nukuoro, showing that (i) there is no overt ergative or absolutive case in the language; and (ii) there is no true verbal phi-agreement. With this backdrop in mind, Section 7.2 provides evidence for abstract ergative Case in the language from the distribution of nominals in non-finite clauses. I develop a concrete proposal for ergative and absolutive Case assignment in Section 7.3, namely that ergative is a structural Case assigned by Infl and absolutive is a structural Case assigned by *v*, with intransitive arguments receiving Case from both loci. Section 7.4 lays out potential extensions of this proposal to other languages. Section 7.5 concludes.

7.1 Morphological case and agreement in Nukuoro

Nukuoro has a morphologically neutral alignment in case and agreement, which is a feature of some Polynesian Outlier languages (e.g., Luangiua; Salmond 1974) but is relatively uncommon for the broader Polynesian family. Most Polynesian languages have been described as either morphologically ergative (e.g., Samoan, Niuean, Tongan) or morphologically accusative (e.g., Māori, Hawai‘ian). In Samoan, for example, ergative arguments are marked by the preceding particle *e*, while absolutive arguments typically appear in an unmarked form (3).²

(3) Samoan ergative-absolutive alignment (Tollan 2018:2)

- a. Sā fau **e le tamāloa** le fale.
 PST build ERG DET man DET house.ABS
 ‘The man built the house.’
- b. Sā siva le teine.
 PST dance DET girl.ABS
 ‘The girl danced.’

In morphologically accusative Polynesian languages, like Māori, nominative subjects are unmarked, while accusative objects are marked by the preceding particle *i* (4).

(4) Māori nominative-accusative alignment (Harlow 2007:119, 151)

- a. Ka hoko te matua **i ngā tīkiti**.
 PRS buy DET parent.NOM ACC DET ticket
 ‘The parent buys the tickets.’
- b. E tangi ana te tamaiti.
 IPFV weep IPFV DET child.NOM
 ‘The child is/was crying.’

Unlike in these languages, all core arguments in Nukuoro use the same unmarked nominal forms. In this section, I demonstrate the lack of overt morphological case or agreement for core arguments; only genitive case is morphologically marked in the language. I also address several case-like and agreement-like phenomena, showing that these are not true realizations of case or agreement, and thus are not indicative of the language’s alignment. This empirical foundation sets the stage for a discussion of abstract ergative Case in §7.2.

7.1.1 Case and case-like phenomena

Nukuoro nominals have two morphological forms: an unmarked form, which is used for most arguments as well as oblique and focused/topicalized nominals, and a genitive form, which is used

²Yu (2021) argues that absolutive case in Samoan is tonally-marked, realized as a preceding high tone. Absolutive DPs can also be marked by a preceding particle *ia* (Mosel & Hovdhaugen 1992:143; Yu and Ozyildiz 2016), which most commonly appears with proper names.

for possessors, subjects of relative clauses, and subjects of nominalized clauses.³ Full unmarked and genitive pronominal paradigms are provided in Chapter 3 §3.2.1.

Unmarked forms are used for all three core grammatical roles, namely subjects of intransitive verbs (S), subjects of transitive verbs (A), and objects of transitive verbs (O). The use of unmarked forms in these roles is demonstrated for pronouns (5) as well as full nominal arguments (6).

- | | |
|--|---|
| <p>(5) a. Au ne seni.
1SG PFV sleep
'I slept.'</p> <p>b. Soni ne doolohi au.
Johnny PFV chase 1SG
'Johnny chased me.'</p> <p>c. Au ne doolohi Soni.
1SG PFV chase Johnny
'I chased Johnny.'</p> | <p>(6) a. De gauligi ne seni.
DET child PFV sleep
'The child slept.'</p> <p>b. Soni ne doolohi de gauligi.
Johnny PFV chase DET child
'Johnny chased the child.'</p> <p>c. De gauligi ne doolohi Soni.
DET child PFV chase Johnny
'The child chased Johnny.'</p> |
|--|---|

Unmarked forms are also used in oblique, focused, and topicalized contexts: objects of prepositions appear in an unmarked form (7), as do focused nominals, which are fronted and preceded by the focus marker *go* (8). Topicalized nominals, which are fronted and followed by a prosodic break, also appear in an unmarked form (9).

- (7) Objects of prepositions
- | | |
|--|---|
| <p>a. Anu matali au!
dance with 1SG
'Dance with me!'</p> <p>b. Anu matali de gauligi!
dance with DET child
'Dance with the child!'</p> | <p>(ML-20210723)</p> <p>(JR-20230504)</p> |
|--|---|
- (8) Focused nominals
- | | |
|---|---|
| <p>a. Go au e maua i de hudi mai de mamu naa.
COP.FOC 1SG IPFV be.able PREP DET pull.in DIR.PROX DET fish MED
'It's [me]_{FOC} who can pull in that fish.'</p> <p>b. Go de mamu nei aagu e maua i de hudi.
COP.FOC DET fish PROX 1SG.GEN.A IPFV be.able PREP DET pull.in
'It's [this fish]_{FOC} that I can pull in.'</p> | <p>(JR-RR-20190627)</p> <p>(JR-RR-20190627)</p> |
|---|---|

³Genitive marking in relative clauses and nominalized clauses yields a nominative pattern: intransitive and transitive subjects receive genitive case in these environments, while transitive objects are unmarked. I argue in this chapter that this pattern is independent of the broader alignment of the language, which assigns abstract ergative and absolutive Case in the syntax.

(9) Topicalized nominals

- a. Gai **de gauligi**, de gaaduu ga osooso (ia).
 then DET child, DET dog PRSP nuzzle 3SG
 ‘(As for) the child, the dog nuzzled him/her.’ (JR-20220704)
- b. Gai **au**, de gaaduu ga kadi au.
 then 1SG DET dog PRSP bite 1SG
 ‘But (as for) me, the dog bit me.’ (JR-20220704)

In short, there is no alignment marked by case in matrix clauses: core intransitive and transitive arguments share the same unmarked form as oblique and focused/topicalized arguments.⁴

Before moving on, I will address two additional phenomena in the language which are reminiscent of case: namely, *i*-marking on objects of pseudo-transitive constructions and *a*-marking on human proper names. While cognate morphemes have been analyzed as case marking in other Polynesian languages, I will argue here that neither constitutes morphological case in Nukuoro, and instead can be analyzed as a preposition and a preproprial article, respectively.

Recall that Nukuoro shows a class of middle constructions, which are pseudo-transitive constructions that take an unmarked subject argument and an object introduced by *i* or *gi* (10).⁵

(10) Middle constructions

- a. De gauligi laa e vaasuu **i de gaaduu**.
 DET child DIST IPFV like PREP DET dog
 ‘That child likes the dog.’ (ML-20210709)
- b. Denga biliisimani e daudali ange **i/gi denga stoosaa**.
 DET.PL police IPFV follow DIR.3 PREP DET.PL car
 ‘The police are following the cars.’ (JR-20210604)

On the surface, middle constructions in Nukuoro look similar to accusative constructions in other Polynesian languages, which we saw in Māori in (4). In fact, middle constructions in ergative Polynesian languages have been analyzed as instances of split ergativity: Tollan (2018), for instance, argues that Samoan middle constructions are transitive, taking two DP arguments, and assign structural accusative case to their objects which is realized by the particle *i*.

Despite this precedent, I argue that objects of Nukuoro middles are not case-marked DPs, but rather PP arguments which are lexically selected by a subclass of verbs.⁶ In other words, Nukuoro middle constructions are syntactically intransitive, with one DP argument and one prepositional phrase containing the patient argument. Initial evidence for this view comes from the fact that *i*

⁴It is also worth noting that Nukuoro does not appear to use tonal marking to distinguish absolutive arguments, as has been argued by Yu (2021) for Samoan: core arguments in Nukuoro are all marked by a LH* contour on the primary stressed, penultimate mora.

⁵I discuss this use of the term “middle” in Chapter 3, §3.3.1.1.

⁶I assume that case markers and prepositions are structurally distinct: case marking is a realization of a Case feature on a DP, while prepositions head their own projection, namely PP. In this way, case-marked arguments are syntactically nominal, while prepositional arguments are syntactically oblique.

and *gi* are also prepositions in Nukuoro, with *gi* encoding a path of motion and *i* used for nearly all other prepositional relations. Prepositional phrases marked by *i* and *gi* are provided in (11).

(11) Prepositional phrases

- a. Au ne seni **i de hagahala.**
 1SG PFV sleep PREP DET sleeping.mat
 ‘I slept on the sleeping mat.’ (JR-20190603)
- b. Au ga gage nei **gi tua de hale.**
 1SG PRSP climb PROX to DET.top DET house
 ‘I will climb to the top of the house.’ (JR-20190604)

Additionally, objects of middles in Nukuoro show syntactic behavior that aligns with prepositional phrases rather than objects of transitives with respect to passivization, object incorporation, and resumption. First, unlike transitive objects, objects of middle verbs cannot undergo passivization with *-(C)ia/ina*, as shown in (12); the constructed example in (12b) uses passive *ina* and places the agent in an optional by-phrase.

(12) Objects of middles cannot passivize

- a. Denga biliisimani ne daudali ange **i taane laa.**
 DET.PL police PFV follow DIR.DIST PREP DET.man DIST
 ‘The police followed that man.’ (JR-20230106)
- b. ***Taane laa** ne daudali ina ange (i denga biliisimani).
 DET.man DIST PFV follow INA DIR.DIST PREP DET.PL police
 Intended: ‘That man was followed (by the police).’ (JR-20230106)

This behavior distinguishes middle objects from transitive objects, which may be promoted to subject position using the passive (13), and makes them look more similar to prepositional arguments, which also cannot undergo passivization (14).

(13) Transitive objects can passivize

- a. De gauligi ne doolohi **de gaagoo.**
 DET child PFV chase DET chicken
 ‘The child chased the chicken.’ (ML-20210723)
- b. **De gaagoo** gu doolohi ina i de gauligi.
 DET chicken INC chase INA PREP DET child
 ‘The chicken was chased by the child.’ (ML-20210723)

(14) Prepositional phrases cannot passivize

- a. De gauligi ne seni **i de hagahala.**
 DET child PFV sleep PREP DET sleeping.mat
 ‘The child slept on the sleeping mat.’ (JR-20230106)
- b. ***De hagahala** ne seni ina i de gauligi.
 DET sleeping.mat PFV sleep INA PREP DET child
 ‘The sleeping mat was slept on by the child.’ (JR-20230106)

Second, objects of middles cannot undergo noun incorporation, which is typically possible for transitive objects. As shown in (15), an *i*-marked object cannot appear bare within the VP, whose edge is marked by the directional *ange*.⁷

(15) Objects of middles cannot incorporate

- a. Denga biliisimani e [VP daudali ange] i **dangada** i masoaa alodahi.
 DET.PL police IPFV follow DIR.DIST PREP person PREP time all
 ‘The police are following people all the time.’ (JR-20210607)
- b. *Denga biliisimani e [VP daudali (**i**) **dangada** ange] i masoaa alodahi.
 DET.PL police IPFV follow PREP person DIR.DIST PREP time all
 Intended: ‘The police are following people all the time.’ (JR-20210607)

Transitive objects typically can undergo noun incorporation, as in (16), while prepositional phrases cannot (17). Again, objects of middles pattern more closely with prepositional phrases rather than DP objects.

(16) Transitive objects can incorporate

- a. De-laa de hale oogu e [VP llanga ai] **denga gede**.
 DET-DIST DET house 1SG.GEN.O IPFV weave OBL DET.PL basket
 ‘That’s the house where I weave the baskets.’ (JR-20200505)
- b. De-laa de hale oogu e [VP llanga **gede** ai].
 DET-DIST DET house 1SG.GEN.O IPFV weave basket OBL
 ‘That’s the house where I weave baskets.’ (JR-20200505)

(17) Prepositional phrases cannot incorporate

- a. de masoaa oogu ne [VP seni ai] i **de hagahala**
 DET time 1SG.GEN.O PFV sleep OBL PREP DET sleeping.mat
 ‘the time that I slept on the sleeping mat’ (JR-20230209)
- b. *de masoaa oogu ne [VP seni **hagahala** ai]
 DET time 1SG.GEN.O PFV sleep sleeping.mat OBL
 Intended: ‘the time that I slept on sleeping mats’ (JR-20230209)

Finally, objects of middles behave like prepositional phrases with regard to \bar{A} -movement: objects of middles undergo obligatory resumption with the oblique pronoun *ai* when they are questioned or relativized (18).

- (18) Go ai o de biliisimani ne daudali ange *(**ai**)?
 COP.FOC who GEN.O DET police PFV follow DIR.DIST OBL
 ‘Who did the police follow?’ (ML-20210709)

This resumption pattern is also obligatory for prepositional phrases under \bar{A} -extraction (19), whereas resumption with *ai* is impossible for extracted objects of transitives (20).

⁷This behavior in Nukuoro differs from Samoan, where objects of middles can undergo pseudo noun incorporation (Tollan 2018:14), supporting an analysis of Samoan middle objects as case-marked DPs.

- (19) Go hee oou ne hano ***(ai)**?
 COP.FOC where 2SG.GEN.O PFV go.SG OBL
 ‘Where did you go?’ (JR-RR-20190701)
- (20) Go ai o de biliisimani ne doolohi ***(ai)**?
 COP.FOC who GEN.O DET police PFV chase OBL
 ‘Who did the police chase?’ (JR-20230504)

These three diagnostics show that objects of middles in Nukuoro behave syntactically like oblique arguments, rather than DP arguments, as summarized in Table 7.1. Based on these diagnostics, we can conclude that *i*-marking on objects of middles is a preposition, rather than an overt accusative case marker.

	Transitive objects	Prepositional phrases	Objects of middles
Passivization	✓	✗	✗
Object incorporation	✓	✗	✗
Resumption	✗	✓	✓

Table 7.1: Behavior of middle objects in Nukuoro

There is one additional nominal marker to mention, namely the ‘personal article’ *a* (Carroll 1965a:210), which precedes proper names that refer to humans. This form and function of the particle has been reconstructed to Proto-Polynesian (Clark 1976); in Tongic languages, however the personal article has been reanalyzed as an absolutive marker (e.g., Clark 1976; Chung 1978; Seiter 1980). The same reanalysis has not occurred in Nukuoro: the personal article can appear on proper names in any grammatical role, including (in)transitive subject, transitive object, and oblique (21). For this reason, I analyze *a* as a preproprial article which appears before proper names (e.g., Matushansky 2008), and use the gloss PN ‘proper name’.

- (21) a. **A Ruth** ne dalodalo.
 PN Ruth PFV pray
 ‘Ruth prayed.’ (JR-20210426)
- b. **A Ruth** ne gaa-mai hanu mamu pelaaini.
 PN Ruth PFV bring-DIR.PROX some fish fry
 ‘Ruth brought some fried fish.’ (JR-20200610)
- c. De gauligi ne buuludi ange **a Ruth**.
 DET child PFV hug DIR.DIST PN Ruth
 ‘The child hugged Ruth.’ (JR-20200520)
- d. Soni e gaav-ange naa de beebaa gi **a Ruth**.
 Johnny IPFV give-DIR.DIST IRR DET book to PN Ruth
 ‘Johnny will give the book to Ruth.’ (JR-20220704)

In short, while genitive case is overt in the language, Nukuoro does not show any marking on core arguments which can be construed as morphological ergative, absolutive, or accusative case. In the next section, I turn to agreement, showing that verbal inflection in the language is scarce and shows a similarly neutral alignment.

7.1.2 Agreement-like phenomena

In addition to lacking morphological case on core arguments, Nukuoro also does not show morphological alignment via agreement. In general, verbal inflection in the language is highly limited. Nukuoro verbs do not show agreement with subjects or objects; for instance, verbs never inflect for person, as shown in (22): the form of the verb is the same regardless of the grammatical roles of the 1st and 2nd person arguments.

- (22) a. Au gu **gidee** goe.
 1SG INC see 2SG
 ‘I saw you.’ (JR-20230504)
- b. Koe gu **gidee** au.
 2SG INC see 1SG
 ‘You saw me.’ (JR-20230504)

While the language lacks true phi-agreement, a subclass of Nukuoro verbs show inflection for number. The verbs in this class are typically intransitive verbs of motion or position, which mark the plurality of their sole argument via suppletion or reduplication of the initial segment (23). A handful of transitive verbs inflect for number, marking the plurality of the object via the same mechanism (24). In these examples, I underline the plural argument that is reflected by verbal number marking.

- (23) a. Ia gu dangi.
 3SG INC cry
 ‘He cried.’ (JR-20230209)
- b. Gilaadeu gu **tangi**.
 3PL INC cry.PL
 ‘They cried.’ (JR-20230209)
- (24) a. Au ne hudi mai dahi mamu.
 1SG PFV pull.in DIR.PROX one fish
 ‘I pulled in a fish.’ (JR-20230209)
- b. Au ne **hudi** mai hanu mamu lagolago.
 1SG PFV pull.in.PL DIR.PROX some fish many
 ‘I pulled in many fish.’ (JR-20230209)

Based on the above examples alone, one might assume that Nukuoro shows an absolutive alignment in agreement, which only marks number distinctions. However, additional properties

reveal that the pattern in (23) and (24) is more fruitfully analyzed as participant number (or “number accord”; Durie 1986; Mithun 1988; Corbett 2000), a cross-linguistically robust phenomenon whereby verbs reflect the plurality of absolutive arguments.⁸ In fact, Haji-Abdolhosseini et al. (2002) describe a similar pattern of number reduplication in Niuean, which they attribute to participant number rather than true phi-agreement.

Participant number shows various cross-linguistic properties that are unexpected of canonical agreement. Some key properties of participant number are summarized in (25), drawing on the overview in Haji-Abdolhosseini et al. (2002).

- (25) Characteristic properties of participant number
- a. exhibits an absolutive pattern, regardless of the case system of the language
 - b. use of suppletion/reduplication
 - c. only a restricted set of verbs show participant number marking
 - d. where grammatical number and notional number differ (e.g., *pluralia tantum*), participant number reflects notional number
 - e. in syntactic contexts where agreement is characteristically absent (e.g., in infinitives), stems still show participant number
 - f. participant number is often preserved in derivational word formation, whereas agreement is not

We have already observed that Nukuoro shows properties (25a) and (25b): number marking shows an absolutive pattern and uses reduplication. Number marking can also be suppletive: the verb root ‘come’ appears as *hu* with a singular subject, but *loo* with a plural subject (26).

- (26) a. Ia gu **hu**-mai.
 3SG INC come.SG-DIR.PROX
 ‘He came.’ (JR-20190603)
- b. Gilaadeu gu **loo**-mai.
 3PL INC come.PL-DIR.PROX
 ‘They came.’ (JR-20190603)

These two properties show that the Nukuoro pattern could plausibly be analyzed as participant number. The properties in (25c-f), however, show more concretely that number marking in Nukuoro should not be analyzed as canonical phi-agreement. First, number marking is limited to a particular subclass of verbs, which is unexpected if agreement is carried out by functional structure (Haji-Abdolhosseini et al. 2002). For instance, there are intransitive verbs, like *midi* ‘dream’ (27), and transitive verbs, like *saabai* ‘carry’ (28), which do not reflect the plurality of the subject or object: the verb appears in the same form even when all arguments are plural.

⁸Traditionally, participant number is described as affecting only internal arguments, namely unaccusative subjects and transitive objects. I refrain from characterizing the pattern this way because Nukuoro does not show a clear distinction between unaccusative and unergative predicates. Some classically unergative predicates (e.g., *seni* ‘sleep’, *savini* ‘run’) show participant number in Nukuoro, while others don’t (e.g. *seesee* ‘walk’). As far as I know, all classically unaccusative predicates show participant number in Nukuoro.

- (27) a. Ia ne **midi**.
3SG PFV dream
'He dreamed.' (JR-20190607)
- b. Gilaadeu ne **midi**.
3PL PFV dream
'They dreamed.' (JR-20190607)
- (28) a. Ia ne **saabai** de gede.
3SG PFV carry DET basket
'He carried the basket.' (JR-20190607)
- b. Gilaadeu ne **saabai** denga gede.
3PL PFV carry DET.PL basket
'They carried the baskets.' (JR-20190607)

Second, number marking is sensitive to notional or semantic number, rather than grammatical number, suggesting that it is not carried out by a syntactic operation like Agree. This property only becomes visible with a noun whose grammatical number differs from its notional number. One such noun in Nukuoro is the noun *gau*, which refers to a group of 3 or more people; despite being notionally plural, this noun may only appear with the singular determiner *de*, reflecting its singular grammatical status (29).

- (29) a. de gau
DET.SG people
'the (grouping of) people' (JR-20190603)
- b. *denga gau
DET.PL people
Intended: 'the people' (JR-20190603)

If number marking were true agreement, we would expect *gau* to appear with singular verbal marking; however, *gau* obligatorily triggers plural inflection on the verb, as shown in (30), demonstrating that plural inflection tracks notional number, rather than grammatical number.

- (30) a. *De gau ne **hu**-mai.
DET.SG people PFV come.SG-DIR.PROX
'The people came.' (JR-20190603)
- b. De gau ne **loo**-mai.
DET.SG people PFV come.PL-DIR.PROX
'The people came.' (JR-20190603)

Third, participant number persists in non-finite environments, which often lack agreement cross-linguistically. In §7.2.1, I argue that Nukuoro has two non-finite constructions: subjunctive *gi*-clauses and nominalized clauses. Verbs in both of these constructions preserve participant number marking, as shown in (31a) and (31b), respectively.

- (31) a. Agai e dahi dangada ga haga-ago luu daagami [gi
 then IPFV one person PRSP CAUS-learn/teach DET.DU guard SBJV
loo-mai gi velo-sia a Logo].
 come.PL-DIR.PROX SBJV stab-CIA PN Logo
 ‘Then someone instructed two guards to come and stab Logo.’ (Haini, 12-1, line 32)
- b. Dangada gu dee maua i de [**hulo** gi ngaiho].
 person INC NEG be.able PREP DET go.PL to north
 ‘People couldn’t go north.’ (Otto, 11-4, line 5)

Finally, participant number is preserved on stems that have undergone derivational word formation, a behavior which is typically not observed for canonical phi-agreement. When Nukuoro verbs are causativized, for example, the verb stem may still mark participant number (32).⁹

- (32) Gai gilaadeu ga haga-**baakuu** gi lalo.
 then 3PL PRSP CAUS-fall.PL to below
 ‘So they made (themselves) fall down below.’ (Otto, 11-4, line 36)

These hallmark properties of participant number have led many authors to analyze participant number as a semantic phenomenon, which could be considered a subtype of pluractionality or event number (e.g., Lasersohn 1995; Mithun 1988; Corbett 2000; Bar-El et al. 2001; Haji-Abdolhosseini et al. 2002; Veselinova 2006; Drummond 2020).¹⁰ On this view, a verb with plural number indicates a particular type of plural event, namely one that involves action by more than one individual; in Drummond (2020), I argue that participant number can be formalized as a cardinality presupposition, which targets the first argument to compose with the verb. I follow these semantic analyses of participant number here, meaning that number reduplication reveals nothing in particular about the morphological alignment of Nukuoro.

7.2 Evidence for abstract ergative Case

So far, we have seen that Nukuoro matrix clauses do not show any morphological alignment in case or agreement. Without overt case distinctions, it is not immediately apparent that Case is assigned in the language at all.

The existence of an ergative extraction restriction is itself a piece of evidence that the language is ergative in the syntax: formal analyses of syntactic ergativity overwhelmingly rely on abstract Case to derive ergative extraction restrictions (e.g., Campana 1992; Bittner & Hale 1996a; Coon et al. 2014). In the previous chapter, I ruled out the two existing types of analyses that would allow us to avoid positing abstract ergative Case, namely object inversion accounts (e.g., Aldridge 2004;

⁹Although as I note in Chapter 3, §3.3.3.1, causativized stems do not obligatorily show participant number.

¹⁰An alternative class of accounts treats participant number as a syntactic phenomenon, such as verbal suppletion triggered by a plural feature on the internal argument (Toosarvandani 2016; Bobaljik & Harley 2017) or an Agree relation between the internal argument and a verb-internal number node (Thornton 2020). I reject this class of accounts based on data like (30), where participant number clearly does not reference syntactic number features.

Coon et al. 2021) and anti-locality accounts (e.g., Erlewine 2016). With these alternatives ruled out, we are left with a set of analyses that take syntactic ergativity to be fundamentally linked to ergative Case assignment. The analysis presented in the previous chapter is no different, casting ergative extraction restrictions as an \bar{A} -sensitivity to abstract Case features on DP goals.

In this section, I provide additional evidence from nominal licensing that Nukuoro is sensitive to abstract Case distinctions. In clauses that lack finite inflectional marking—namely clausal nominalizations, subjunctive clauses, and imperative clauses—transitive subjects fail to be licensed, while other core arguments, including transitive objects, may appear freely. This licensing pattern suggests that finite Infl is responsible for assigning abstract ergative Case to the transitive subject. The loss of ergative licensing in non-finite clauses is a key prediction of structural ergative accounts, and non-finite clauses have been integral to understanding licensing in ergative systems in general (e.g., Johns 1992; Bobaljik 1993; Coon et al. 2014; Rezac et al. 2014). I develop an implementation of structural ergative Case assignment in §7.3, building on insights from Levin & Massam (1985), Bobaljik (1993), Laka (1993), and Rezac et al. (2014).

7.2.1 Nukuoro non-finite constructions

There are three kinds of non-finite clauses in Nukuoro, which lack aspect morphology: (i) subjunctive clauses, which use the invariant particle *gi*; (ii) imperative clauses; and (iii) clausal nominalizations. Assuming that aspect morphology realizes finite Infl, these constructions either involve a deficient form of Infl (e.g., subjunctive clauses) or lack an Infl projection altogether (e.g., imperatives and nominalizations), and thus lack the Case value typically assigned by Infl.

The first class of non-finite clauses are subjunctive clauses, which use the subjunctive particle *gi* and appear most often in embedded contexts. Predicates like *lodo* ‘want’, *hili* ‘choose’, and *dugu* ‘allow’ can take two kinds of embedded complements in Nukuoro. One type of complement, which I take to be fully finite, can appear with the full range of aspect markers (33a). In the second type of complement (33b), aspect marking is absent, and the subjunctive particle *gi* (> Proto-Polynesian **ke*) follows the pre-verbal subject. Both types of complements can optionally use the complementizer *bolo*.

- (33) a. Ia e lodo (bolo) Soni e anu.
 3SG IPFV want COMP Johnny IPFV dance
 ‘S/he wants Johnny to dance.’ (JR-20230504)
- b. Ia e lodo (bolo) Soni **gi** (*e) anu.
 3SG IPFV want COMP Johnny SBJV IPFV dance
 ‘S/he wants Johnny to dance.’ (JR-20230504)

I have argued that subjunctive *gi*-clauses are formally non-finite, selecting for a deficient form of Infl. In Chapter 4, I analyzed subjunctive *gi* as a low complementizer, which occupies the C_1 projection that is responsible for moving the pre-verbal subject to its specifier (following Middleton 2021). The subjunctive complementizer *gi* is incompatible with finite inflectional marking, which typically undergoes T-to-C movement (Massam 2000, 2001; Custis 2004; Otsuka

2005; Collins 2017; Middleton 2021); for this reason, *gi* may only combine with non-finite Infl, which has no overt exponence and (as I show below) does not assign Case. Evidence that subjunctive clauses lack finite Infl comes from the fact that they are invariant for tense/aspect (34) and cannot be combined with other aspect markers (35), suggesting that *gi* cannot co-occur with finite Infl.

- (34) a. Au **e** lodo (bolo) [Mina **gi** hano (daiao)].
 1SG IPFV want COMP Mina SBJV go tomorrow
 ‘I want Mina to leave (tomorrow).’ (JR-20210923)
- b. Au **ne** lodo (bolo) [Mina **gi** hano (anaahi)].
 1SG PFV want COMP Mina SBJV go yesterday
 ‘I wanted Mina to leave (yesterday).’ (JR-20210923)
- (35) a. Au ne lodo (bolo) [Mina **gi** {*e / *ne / *nogo} seni].
 1SG PFV want COMP Mina SBJV IPFV / PFV / PST.IPFV sleep
 ‘I wanted Mina to { sleep / be sleeping / have slept }.’ (JR-20210923)
- b. Au ne lodo (bolo) [Mina {*e / *ne / *nogo} **gi** seni].
 1SG PFV want COMP Mina IPFV / PFV / PST.IPFV SBJV sleep
 ‘I wanted Mina to { sleep / be sleeping / have slept }.’ (JR-20210923)

It is worth noting that subjects of subjunctive clauses may optionally be preceded by the complementizer *bolo*, showing that subjects may remain inside the lower clause.¹¹ Furthermore, we can note that subjects of *gi*-clauses do not (always) receive Case licensing from outside of the embedded clause: subjunctive clauses can stand on their own as matrix clauses, where they receive a deontic interpretation (36).

- (36) a. Koe **gi** anu.
 2SG SBJV dance
 ‘You should dance (according to some authority).’ (JR-20230504)
- b. Soni **gi** dolohia taane laa.
 2SG SBJV follow.CIA DET.man DIST
 ‘Johnny should follow that man (according to some authority).’ (JR-20230504)

Since there is no embedding verb in these constructions, licensing for both arguments must be coming from within the non-finite clause itself.

A second class of non-finite constructions are imperative clauses, which lack aspect marking (37a). It is impossible to add aspect morphology to imperatives, including the generic aspect marker *e* or the prospective aspect marker *ga* (37b); I take this to indicate that imperatives lack an Infl projection altogether.

¹¹When *bolo* is absent, it is not clear whether the subject remains within the embedded clause or raises to object position of the matrix clause. Regardless, the arguments that I present below hold whether or not there is a raising-to-object derivation for these constructions.

- (37) a. Dele gi de bido laa!
 sail to DET side DIST
 ‘Sail to the other side!’ (JR-20190624)
- b. *{E / Ga } dele gi de bido laa!
 IPFV PRSP sail to DET side DIST
 Intended: ‘Sail to the other side!’ (JR-20230504)

Since the following discussion investigates nominal licensing in non-finite clauses, I note that while subjects of imperative clauses are generally covert, I assume that null subjects of imperatives are syntactically represented 2nd persons (e.g., Schmerling 1975; Platzack & Rosengren 1997; Zanuttini 2008).

The final type of non-finite clauses are clausal nominalizations, which lack inflectional marking as well. Nominalized clauses are used for complements of predicates thought to involve restructuring (Wurmbrand 2001), such as ‘want’, ‘be able’, ‘stop’, and ‘begin’. These nominalizations are introduced by the singular determiner *de* and assign genitive to the highest nominal argument, namely the subject (38).

- (38) a. Ga daamada i **de** [savini o **de** gauligi laa].
 PRSP begin PREP DET run GEN.O DET child DIST
 ‘The child began to run.’ (JR-20210604)
- b. Ga lava huu **de** [hua ange a **de** gau laa de mee]...
 PRSP finish when DET sing DIR.3 GEN.A DET people DIST DET thing
 ‘When those people finished singing it...’ (Haini, 12-1, line 81)

Clausal nominalizations in Nukuoro are structurally reduced compared to matrix clauses. First, they are obligatorily verb-initial, showing that they are large enough to host predicate fronting but too small to host a pre-verbal subject (following the clause structure developed in Chapter 4); second, they cannot host aspect marking, suggesting that they are not large enough to contain an Infl projection (39).

- (39) Ga daamada i de [{*e / *ga} savini o de gauligi laa].
 PRSP begin PREP DET IPFV PRSP run GEN.O DET child DIST
 Intended: ‘The child began to run.’ (JR-20230504)

The lack of aspect marking combined with obligatory VSO order suggests that nominalization targets FP, the projection just below Infl which hosts the fronted predicate, as argued in Chapter 4. I assume that these FP-sized constituents are nominalized via a higher *n* projection, which also assigns genitive to the most local nominal; this mechanism of genitive assignment is akin to that found in genitive relative clauses (see Chapter 5). This structure is schematized in (40).

- (40) Infl V [PP *i* [DP *de* [nP ^{n⁰} [FP VP Subj Obj VP]]]]
 └── GEN ─┘

All of these contexts, which either show invariant TAM marking or lack TAM marking, can be characterized as formally non-finite: they lack the inflectional structure present in canonical finite clauses. In what follows, I demonstrate that these contexts also show licensing failures associated with the absence of finite Infl, which display an ergative pattern.

7.2.2 Ergatively-aligned licensing behavior

Without case morphology, Case assignment can be identified only in its absence: assuming that there is a nominal licensing requirement (i.e., the Case Filter), the derivation fails when a nominal does not receive Case. Thus, in order to diagnose the abstract alignment of Nukuoro, it is necessary to identify which arguments—if any—fail to be licensed non-finite clauses, which lack finite Infl and therefore lack a potential Case assigner.

The licensing predictions can be laid out as follows. The null hypothesis is that there are no licensing effects in the language, which means that all arguments will appear as expected in non-finite environments with no additional morphology. If there are licensing effects, however, there are three potential Cases that have been attributed to Infl, which would fail to be assigned in non-finite clauses: nominative (Chomsky 2000, 2001), absolutive (Murasugi 1992; Bittner 1994; Bittner & Hale 1996a; Ura 2001), or ergative (Levin & Massam 1985; Bobaljik 1993; Laka 1993; Rezac et al. 2014). Each of these analyses makes different empirical predictions for non-finite clauses, leaving a different argument or pair of arguments unlicensed when finite Infl is absent. These predictions are summarized in Table 7.2; I use S, A, and O as a shorthand to represent intransitive subjects, transitive subjects, and objects, as is standard in the ergativity literature.

	Licensing for S?	Licensing for A?	Licensing for O?
No licensing effects	✓	✓	✓
Infl assigns [NOM]	✗	✗	✓
Infl assigns [ABS]	✗	✓	✗
Infl assigns [ERG]	✓	✗	✓

Table 7.2: Predictions for licensing in non-finite clauses

If an argument fails to be licensed, we expect that the standard non-finite construction containing that argument will be ungrammatical. Given other cases of “repair” for Case licensing failures, we might expect to find an alternative grammatical construction which inserts additional structure, such as a preposition or non-canonical verbal morphology, to provide licensing for the argument in question.

In Nukuoro non-finite clauses, I will now show that transitive objects and intransitive subjects are licensed normally, ruling out an analysis where Infl assigns nominative or absolutive Case. Rather, it is the transitive subject which requires an additional source of licensing in non-finite clauses. In nominalizations, the transitive subject is licensed by a functional head in the nominal

domain, receiving genitive marking which provides alternative licensing in the absence of Infl; in subjunctives and imperatives, transitive clauses require the addition of *-(C)ia + ina*, the same repair found in ergative extraction environments.

First, let us consider the pattern in nominalizations. Since the nominal structure of these clauses always assigns genitive to intransitive and transitive subjects, these clauses do not present an opportunity to discover any particular licensing behavior for subjects. We can observe, however, that transitive objects may appear unmarked within clausal nominalizations (41), showing that objects are licensed in the absence of Infl.

- (41) Gu lava i [de hai ange a de hine laa **de hada**].
 INC finish PREP DET fix GEN.A DET woman DIST DET car
 ‘The woman finished fixing the car.’ (JR-20211118)

The fact that transitive objects may appear unmarked in these clauses rules out the possibility that Infl is responsible for assigning absolutive Case: if it were, we would expect objects to require additional licensing in contexts like (41). Instead, objects appear to be licensed by a functional projection low enough to be present in a structurally reduced clause, such as *v*.

With licensing for objects established, we can now turn to the behavior of subjects, which can be observed in *gi*-clauses and imperatives. Beginning with *gi*-clauses, we can observe that subjects of intransitive (42a) and middle verbs (42b) may appear freely.

- (42) a. Au e lodo (bolo) [Mina gi hano daiao].
 1SG IPFV want COMP Mina SBJV go tomorrow
 ‘I want Mina to leave tomorrow.’ (JR-20210923)
- b. Au ne dugu ange (bolo) [Mina gi daudali ange i taane laa].
 1SG PFV allow DIR.DIST COMP Mina SBJV follow DIR.DIST PREP DET.man DIST
 ‘I allowed Mina to follow that man.’ (JR-20230106)

Since intransitive subjects can appear without any additional morphology, finite Infl cannot be responsible for licensing the intransitive subject. This rules out an analysis where Infl assigns nominative Case.

The last remaining question is whether Infl is responsible for licensing the transitive subject. In fact, we find that it is not possible to create an unmarked subjunctive transitive clause, as shown in (43), suggesting that *gi*-clauses cannot license both arguments of a transitive verb. Instead, transitive subjunctive clauses require *-(C)ia/ina* morphology on the verb, the same morphology that appears in ergative extraction contexts (43b).

- (43) a. *Ruth e lodo (bolo) [au gi buuludi ange Soni].
 Ruth IPFV want COMP 1SG SBJV hug DIR.DIST Johnny
 ‘Ruth wants me to hug Johnny.’ (JR-20210923)
- b. Ruth e lodo (bolo) [au gi **buuludi ina** ange Soni].
 Ruth IPFV want COMP 1SG SBJV hug INA DIR.DIST Johnny
 ‘Ruth wants me to hug Johnny.’ (JR-20210923)

Similar behavior holds in imperative clauses: intransitive imperatives (44a) and middle imperatives (44b) use an unmarked verb form, while transitive imperatives cannot appear in their unmarked form. Instead, transitive imperatives obligatorily appear with *-(C)ia/ina* (44c).

- (44) a. Savini (*ina) gi kilaa.
run INA to there
‘Run over there.’ (JR-20190624)
- b. Gahu (*ina) i ssingilidi nei.
wear INA PREP DET.tshirt PROX
‘Wear this t-shirt.’ (JR-20190624)
- c. Hao *(ina) de hoe gi lote moni.
put.in INA DET paddle to inside.DET canoe
‘Put the paddle inside the canoe.’ (JR-20190624)

The ungrammaticality of unmarked transitive non-finite clauses suggests that one of the two transitive arguments fails to be licensed in the absence of Infl. We already know from clausal nominalizations that transitive objects may appear freely in the absence of Infl; we can deduce, then, that it is the transitive subject which fails to be licensed in these contexts. As a result, *(C)ia/ina* morphology must appear in order to provide alternative licensing for the transitive subject, which is consistent with the analysis of *(C)ia/ina* as an absolutive Case licenser developed in the previous chapter. The same repair is not necessary for nominalized clauses, where transitive subjects receive genitive Case instead.

To summarize, intransitive subjects and transitive objects are licensed in non-finite clauses, while transitive subjects alone require alternative licensing strategies. This behavior indicates that Infl is responsible for assigning ergative Case in Nukuoro, as summarized in Table 7.3.

	Licensing for S?	Licensing for A?	Licensing for O?
No licensing effects	✓	✓	✓
Infl assigns [NOM]	✗	✗	✓
Infl assigns [ABS]	✗	✓	✗
Infl assigns [ERG]	✓	✗	✓
Nukuoro	✓	✗	✓

Table 7.3: Licensing in Nukuoro non-finite clauses

The connection between ergativity and licensing in non-finite clauses has been reported elsewhere in the literature, but has been used to draw very different conclusions from those drawn here. For instance, similar behavior has been reported for Q’anjob’al, where Agent Focus morphology appears in both ergative extraction contexts and transitive non-finite clauses. Coon et al.

(2014) take this distribution to suggest that Infl is responsible for licensing the transitive *object*, supporting a view where Infl assigns absolutive Case.¹²

While it may be tempting to extend this analysis to Nukuoro, the licensing behavior across all three types of non-finite clauses render it impossible to maintain this view. First and foremost, licensing for the transitive object survives in Nukuoro nominalized clauses, despite lacking Infl altogether. If Infl were responsible for assigning absolutive Case to objects, we would expect transitive nominalized clauses to require *(C)ia/ina* morphology for object licensing. Additionally, if Infl were an absolutive Case assigner, we would expect to see a licensing failure for intransitive subjects of non-finite clauses as well. This prediction is not borne out: intransitive *gi*-clauses and imperatives appear unmarked and require no additional licensing structure, suggesting that intransitive subjects receive Case from a functional head other than Infl.

Nukuoro licensing behavior shows that the language is sensitive to ergativity in the syntax outside of extraction, and furthermore, that licensing for the ergative subject is tied to Infl. In the next section, I adopt and flesh out a structural view of ergative Case assignment, and describe how it extends to cover the range of Nukuoro patterns in \bar{A} -extraction and non-finite clauses.

7.3 A model of structural ergative and absolutive Case

In this section, I lay out a model of ergative and absolutive Case assignment which captures the range of empirical patterns in Nukuoro. Based on the extraction and licensing patterns described previously, we can identify two classes of arguments in Nukuoro, which correspond to ergative and absolutive arguments cross-linguistically. The defining properties of these two classes in Nukuoro, along with the arguments that fall into each class, are summarized in Table 7.4.

	PROPERTIES	TYPES OF ARGUMENTS
ERGATIVES	Cannot \bar{A} -extract Require licensing from Infl	Transitive subjects
ABSOLUTIVES	Can \bar{A} -extract Remain licensed without Infl	Intransitive subjects Subjects of middles Transitive objects Transitive subjects with incorporated objects

Table 7.4: Empirical characteristics of ergatives and absolutives in Nukuoro

There are two crucial aspects of the distribution in Table 5 that our model of Case seeks to capture. First, ergative arguments show a dependency with Infl, which absolutive arguments lack; this dependency motivates a structural view of ergative Case from Infl, while absolutive

¹²On their account, non-finite clauses fail to license transitive objects and intransitive subjects, and Agent Focus appears in transitive contexts to license the transitive object. A different repair is used for intransitive subjects: they are unexpectedly co-indexed using Set A agreement, which is used for ergatives and possessors.

arguments have another source of Case assignment. Second, by looking at the types of arguments that fall into each class, the class of ergatives can be characterized dependently: external arguments fall into the ergative class only when there is a standard nominal object. By contrast, external arguments behave like absolutes when there is no object, or when the object is structurally non-standard in some way. Specifically, subjects are absolute in middles, where objects are couched within prepositional structure, and in clauses with incorporated objects, where the object is an N^0 adjoined to the verbal head. While the dependent nature of ergative has often been used to support a configurational approach to Case assignment (e.g., Baker 2015), I develop an account that captures this dependency between ergativity and object behavior using a structural analysis, which attributes this dependency to probe-goal intervention effects.

To account for the non-finite clause data described in Section 7.2, I posit a nominal licensing requirement in Nukuoro, such as the Case Filter (Chomsky 1981), which states that the derivation crashes if a nominal fails to receive Case. I adopt the version of the Case Filter provided in (45).

(45) *Case Filter*

Every nominal must receive Case.

I propose that ergative in Nukuoro is a structural Case, assigned via Agree with Infl (Levin & Massam 1985; Bobaljik 1993; Laka 1993; Otsuka 2000; Rezac et al. 2014), while v is the locus of structural absolute Case (Aldridge 2004; Legate 2008b). As both Cases are assigned via Agree, I characterize Case assignment as bidirectional feature exchange (Pesetsky & Torrego 2001; Clem 2019), where agreement probes copy back features from a goal, and in return, pass on their category feature to that goal (Deal To appear). As a result, Case features can be understood not as featural primitives, but rather as the existence of a category feature on a nominal: ergative arguments are characterized by the presence of an [Infl] feature alone, while all absolute arguments possess a [v] feature. This implementation of Case assignment can be considered “goal flagging”, to use terminology from Deal To appear): goals are assigned a feature which indicates their agreement with a particular probe.

The classic challenge for structural ergative approaches arises in intransitive constructions: intransitive subjects are presumably licit goals for Agree with Infl, yet they are not ergative. Previous structural ergative accounts have proposed that only transitive Infl assigns ergative, to prevent the assignment of ergative in intransitive contexts (Levin & Massam 1985; Bobaljik 1993; Laka 1993; Rezac et al. 2014). Here, I propose a model of Case assignment where intransitive subjects do, in fact, agree with Infl, in addition to agreeing with v . In languages with overt morphological case, the case form of the intransitive subject is determined after the application of a morphological impoverishment rule, which deletes one category feature in the context of the other. In the syntax, however, intransitive subjects carry two category features, and thus show the syntactic behavior associated with both relationships. I will refer to this system as a *flexible intransitive* account, since intransitives may be grouped with either the transitive subject or the object for the purposes of the syntax and/or morphology.

After introducing this proposal in more detail, I first apply the Case assignment mechanism to Nukuoro, showing how the account captures the ergative extraction behavior as well as the licensing pattern in non-finite clauses. I then discuss alternative proposals for ergative Case

assignment, namely inherent and configurational approaches, and show that these proposals face challenges in accounting for the Nukuoro data.

7.3.1 The proposal: Flexible intransitives

There are two functional heads which may agree with arguments in Nukuoro, namely Infl and v . The novel proposal put forth here is that intransitives are “flexible” in the sense that they agree with *both* Infl and v , receiving category features from both heads. Thus, in the syntax, ergative arguments are characterized by agreement *only* with Infl; absolutive arguments, on the other hand, are characterized by agreement with v , whether or not they also agree with Infl. This characterization of traditional Case categories is summarized in (46).

- (46) Correspondences between Agreement and Case
- a. Ergative subjects: [Infl]
 - b. Absolutive arguments: [v , (Infl)]

To flesh out the proposal, I propose that v carries a phi probe, which Agrees with the single most local nominal in its c-command domain; in Deal’s (2015b) terms, the probe on v interacts with and is satisfied by phi, halting after it copies back a single set of phi features. This agreement with v characterizes the goal argument as absolutive, according to the correspondence principles in (46). In Chapter 4, I showed that internal arguments in Nukuoro always vacate the VP prior to predicate fronting. I propose that this Agree relationship with v triggers movement of a goal to its (inner) specifier, notated here by M in the satisfaction condition, after Deal (To appear).¹³ In other words, v carries the following probe: [INT: ϕ , SAT: ϕ^M].

In intransitive clauses, v Agrees with intransitive subjects regardless of their base position. In unaccusative constructions, v agrees with the internal argument, passing on its category feature, and moves it to its specifier. In unergative constructions, where the intransitive subject is merged in Spec, v P, v will fail to find a nominal in its c-command domain. I assume, however, that an unsatisfied probe may undergo *cyclic expansion* (Rezac 2003, 2004; Béjar & Rezac 2009), where the probe may reproject to the immediately dominating node along with its category feature. In this position, the probe searches its expanded c-command domain and may Agree with the nominal in its specifier, allowing v to Agree with the unergative subject. v -agreement with intransitive subjects of unaccusatives and unergatives is demonstrated in (47) and (48), respectively.

¹³In Chapters 4 and 6, I argue that movement of the internal argument “tucks in” below the external argument.

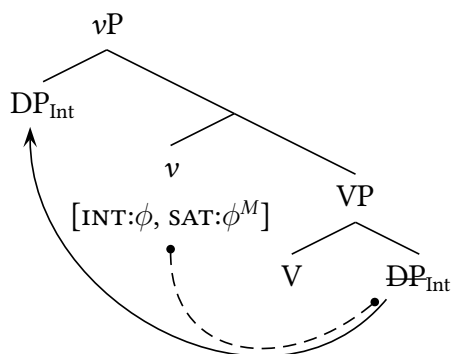
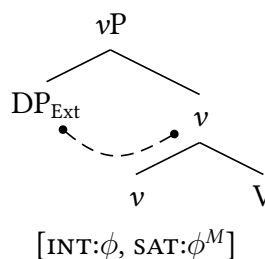
(47) *v*-agreement in unaccusatives(48) *v*-agreement in unergatives

Turning to transitive clauses, I propose that Infl Agrees with the most local nominal in its c-command domain, with a probe specification of $[\text{INT}:\phi, \text{SAT}:\phi]$. Unlike *v*, Infl in Nukuoro does not trigger movement of the goal to its specifier.¹⁴ In clauses with two DP arguments, *v* will Agree with the internal argument and move it to its (inner) specifier; Infl will Agree with the external argument, as shown in (49).

(49) Agreement in transitive clauses

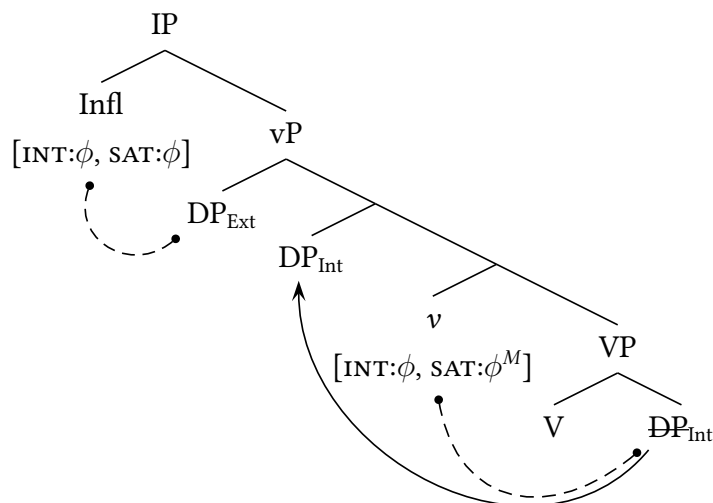

In this way, the present account likens ergative to nominative (ERG = NOM), as both involve Agree with Infl, and absolutive is akin to accusative (ABS = ACC), as both involve Agree with *v*. This approach stands in contrast to other approaches, which liken absolutive to nominative (ABS = NOM; Murasugi 1992; Bittner & Hale 1996b; Ura 2001; Legate 2008b) and/or take ergative to be

¹⁴Since Infl is above the landing site of the fronted predicate (see Chapter 4), movement to Spec,IP would result in SVO word order. I argue in §4.3.1 of Chapter 4 that Spec,IP is not a possible landing site of movement because maximal IPs cannot be SVO.

an inherent Case (Woolford 1997, 2006; Legate 2004, 2008b). I address other approaches to ergative/absolutive Case assignment and their challenges for Nukuoro in Section 7.3.3.

The proposal that I have laid out so far has not addressed the role of Infl in intransitive clauses. As stated above for transitive contexts, Infl carries a probe which Agrees with the closest nominal and assigns it ergative Case; in intransitive clauses, the sole argument should act as a goal for Infl as well as *v*, receiving two category features. This configuration is schematized in (50).

(50) Agreement in intransitive clauses

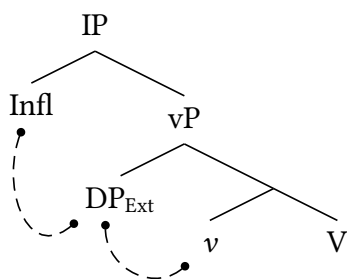

The kind of configuration in (50) has traditionally been deemed problematic for structural ergative approaches, since intransitive subjects end up showing morphological absolutive case rather than ergative. As such, structural ergative approaches have typically added an additional condition on Case assignment that prevent ergative from being assigned to intransitive subjects. These conditions have been called “default” or “obligatory” Case parameters (Levin & Massam 1985; Bobaljik 1993), which claim that only one Case may be assigned in intransitive clauses. If Infl assigns its Case value in intransitives, a nominative pattern results; if *v* assigns its Case value in intransitives, the result is absolutive. These two transitivity parameters are formalized in (51).

- (51) “Default” or “obligatory” Case parameters (e.g., Levin & Massam 1985; Bobaljik 1993)
- a. *Nominative-accusative systems*: Infl assigns Case in intransitives
 - b. *Ergative-absolutive systems*: *v* assigns Case in intransitives

Unlike previous accounts, I do not adopt (51), and do not try to prevent the configuration in (50): instead, I claim that intransitive subjects *do* enter into two relationships, one with Infl and one with *v*.¹⁵ For the purposes of the syntax, intransitive subjects bear two category features; this system will suffice to capture Nukuoro, for instance, where there is no morphological realization of these features. I show in section 4.2 that this mechanism correctly derives the Nukuoro extraction and non-finite clause behavior.

For languages that show overt morphological case, I propose that the morphological case borne by intransitive subjects can be determined by the application of a morphological impoverishment rule, which eliminates one of the two category features assigned to the intransitive subject. In morphologically ergative languages, the impoverishment rule eliminates the [Infl]

¹⁵In other words, I assume that nominals in Nukuoro are not subject to any kind of Activity Condition (cf. Chomsky 2000, 2001), and can enter into A-dependencies with multiple functional heads (e.g., Baker 2008; Oxford 2017).

feature in the context of a [*v*] feature on the same head (52a). This rule allows the intransitive subject to bear the same morphology as the transitive object, yielding an ergative-absolutive morphological alignment. By contrast, in morphologically accusative languages, the impoverishment rule eliminates the [*v*] feature in the context of an [Infl] feature on the same head (52b). The intransitive subject will thus only retain [Infl], the same feature as the transitive subject, yielding a nominative-accusative morphological alignment.

(52) Case impoverishment rules

- a. *Morphologically ergative systems*: [Infl] → ∅ / __[*v*]
 b. *Morphologically accusative systems*: [*v*] → ∅ / __[Infl]

In the syntax, ergative subjects can be characterized as arguments that have *only* Agreed with Infl. Any argument that has Agreed with *v*—whether or not it Agrees with other functional heads as well—can be characterized as absolutive. One advantage of this system is that it captures the dependent nature of ergative: an argument is only ergative if there is an internal argument to Agree with *v*. This mechanism ensures that *v* will Agree with the external argument under two conditions: (i) there is no internal argument; or (ii) there is an internal argument, but it is not an appropriate target for Agree. This second condition applies in instances where the internal argument is an incorporated N⁰, where it is inaccessible for Agree because it is contained within a complex head (53), or where the internal argument is a PP (i.e., in middle constructions), preventing *v* from Agreeing with the phi features contained within prepositional structure (54).

(53) Case assignment with an N⁰ object

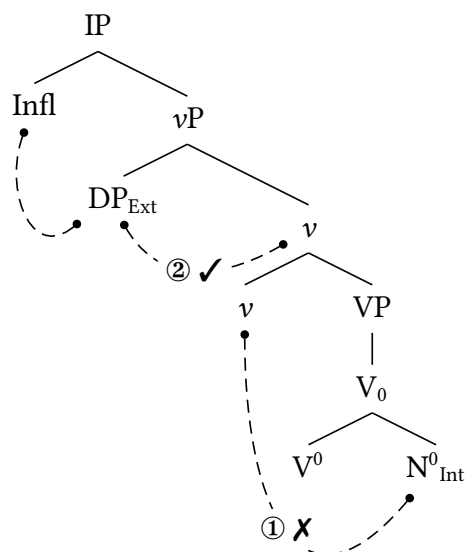

(54) Case assignment with a PP object

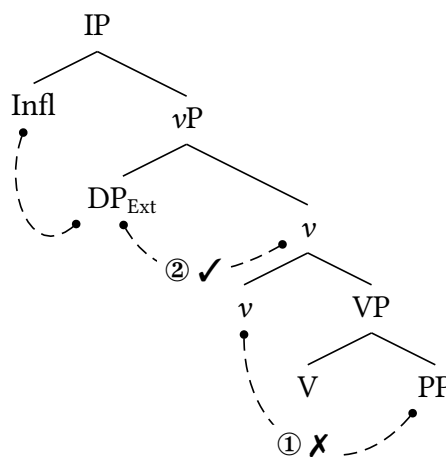

In other words, this account implements the well-known insight that ergativity is dependent on the presence of an (agreeing) object (e.g., Baker & Vinokurova 2010; Deal 2010; Coon et al. 2014; Baker & Bobaljik 2017; Clem 2019; Coon et al. 2021; Yuan 2022) while still maintaining a structural

view of Case assignment. I discuss configurational alternatives to ergative assignment, and their drawbacks, in section 7.3.3.

7.3.2 Accounting for Nukuoro

With the basic nominal licensing mechanisms established, let us explore how this mechanism accounts for Nukuoro \bar{A} -extraction and non-finite clauses.

The previous chapter develops an analysis of extraction restrictions in which an \bar{A} -probe may be sensitive to Case features on potential \bar{A} -goals. For ergative extraction restrictions, I claim that the relevant \bar{A} -probe is a composite probe which seeks an $[\bar{A}]$ feature and an $[\text{ABS}]$ feature on the same goal, restricting licit \bar{A} -movement to absolutive arguments. In the present system, where Case assignment is implemented via bidirectional feature exchange, we can replace $[\text{ABS}]$ with the category feature $[\nu]$, resulting in the composite probe specified in (55).

- (55) *Syntactically ergative \bar{A} -probe (revised)*
 $[\text{SAT: } \bar{A} + \nu^M]$, where $[\nu]$ is borne by absolutive arguments

In other words, all arguments that have Agreed with ν and received its category feature will be eligible for unmarked \bar{A} -extraction. Thus, this probe will pick out all and only absolutive arguments, but fail to be satisfied by transitive subjects, which only agree with Infl.

In transitive clauses, the Case mechanism described above will achieve the correct result for \bar{A} -extraction. Transitive objects agree with ν , and thus are licit targets for Agree with the composite \bar{A} -probe. Transitive subjects, on the other hand, do not agree with ν and do not possess a $[\nu]$ feature: the possibility for agreement with ν has been “absorbed” by the transitive object, leading transitive subjects to only possess features from $[\text{Infl}]$. As a result, transitive subjects cannot satisfy the composite \bar{A} -probe, correctly deriving the restriction on ergative extraction. This state of affairs is summarized in (56).

- (56) \bar{A} -extraction from transitive clauses

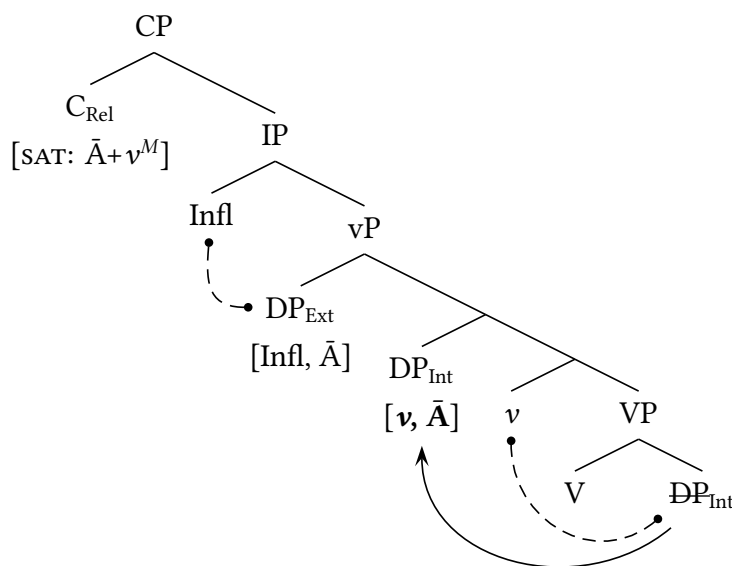

What about intransitive subjects? On the present model, intransitive subjects agree with both Infl and v , possessing two category features [Infl] and [v]. For the purposes of \bar{A} -extraction, this means that intransitive subjects meet the satisfaction conditions of the probe, which only requires that the goal possess a [v] feature. The fact that intransitive subjects also possess an [Infl] feature is irrelevant for the composite probe, which will encounter a number of features on the goal (e.g., phi features) that do not affect the outcome of \bar{A} -movement. The presence of an [\bar{A}] feature and a [v] feature on the goal are sufficient to satisfy the probe, allowing \bar{A} -movement of intransitive arguments to proceed unhindered (57).

(57) \bar{A} -extraction from intransitive clauses

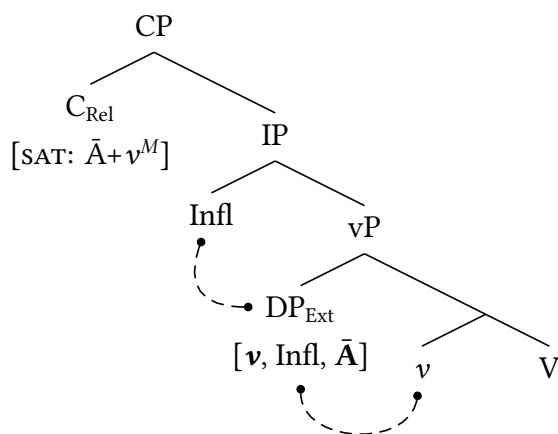

The present account also captures the appearance of *-(C)ia/ina* in non-finite clauses using the same machinery. In the previous chapter, I proposed that *-(C)ia/ina* realizes the head of an additional vP layer, which I label v_{INA} , that appears above the vP projection that introduces the external argument. This v_{INA} head functions as an additional absolutive licenser, which appears to assign exceptional absolutive Case to the transitive subject. In present terms, this additional v projection carries an additional phi-probe which will Agree with the transitive subject, passing on its v category feature and thereby effectively assigning absolutive Case. This configuration is schematized in (58). Crucially, agreement with v_{INA} allows the transitive subject to possess a [v] feature and be a goal for the composite \bar{A} -probe, even though it also agrees with Infl.

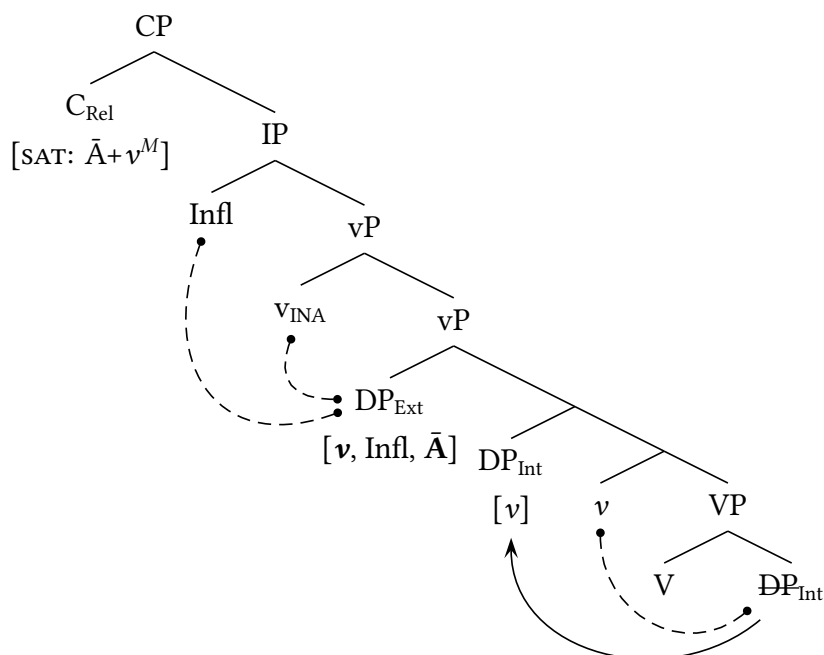
(58) \bar{A} -extraction from transitive clauses with $-(C)ia/ina$ 

In other words, transitive subjects in $-(C)ia/ina$ clauses end up with the same category features as intransitive subjects, namely $[v]$ and $[Infl]$, and thus participate in \bar{A} -movement like intransitive subjects do.

In addition to the $-(C)ia/ina$ repair, extraction of ergatives is also repaired by incorporating the object; in these contexts, it is not necessary to add an additional licenser for the transitive subject. This pattern is captured by the dependent nature of ergative on the present account: incorporated objects are not licit goals for Agree with v , since they are contained within a complex head (e.g., Matushansky 2006), allowing the probe on v to reproject and Agree with the transitive subject (59). Having agreed with v , the transitive subject possesses the correct feature to undergo composite \bar{A} -movement.

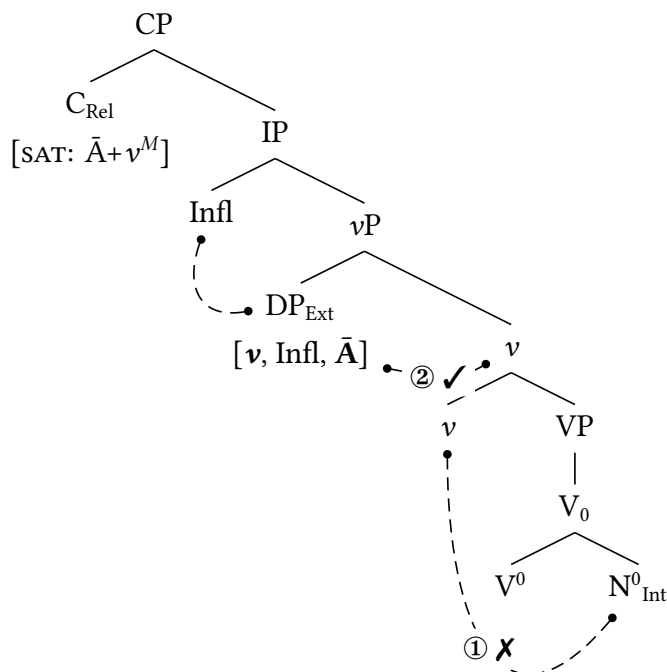
(59) \bar{A} -movement of a subject with an incorporated object

The final pattern to account for concerns licensing in non-finite clauses. The three types of non-finite clauses discussed in §7.2 either lack Infl or contain a deficient form of Infl; as a result, there will be no agreement with Infl in non-finite clauses, reducing the number of Case licensers. Since v is still present, it will continue to agree with transitive objects and intransitive subjects, as shown in (60) and (61).¹⁶ Transitive subjects, however, which undergo Agree with only Infl in finite clauses, will not enter into any Agree relations when Infl is absent (61). As a result of the Case Filter, the structure in (61) will be ruled out.

(60) Intransitive non-finite clauses

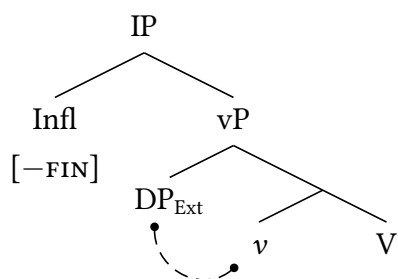

(61) Transitive non-finite clauses

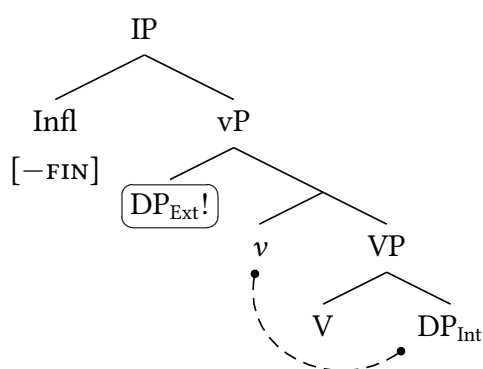

¹⁶In non-finite contexts, v will also agree with external arguments when the internal argument is incorporated, akin to (59), and when the internal argument is contained within a PP (i.e., in middles). These facts parallel the ergative extraction contexts laid out above.

The licensing failure for transitive subjects is remedied in two different ways across the non-finite contexts. In subjunctive clauses and imperatives, *-(C)ia/ina* appears and provides alternative licensing for the transitive subject, preventing a violation of the Case Filter (62).

(62) Transitive non-finite clauses with *-(C)ia/ina*

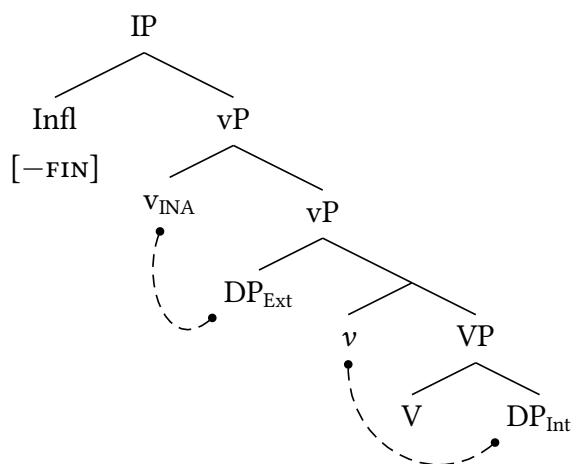

Meanwhile, in nominalized clauses, the higher nominalizing *n* agrees with the transitive subject, assigning genitive Case (i.e., an *n* feature) and preventing a Case Filter violation (63). Since a genitive Case assigner is already present, nominalized clauses do not require the addition of a *v* head (e.g., *-(C)ia/ina*) to license the transitive subject.¹⁷

(63) Case licensing in nominalized clauses

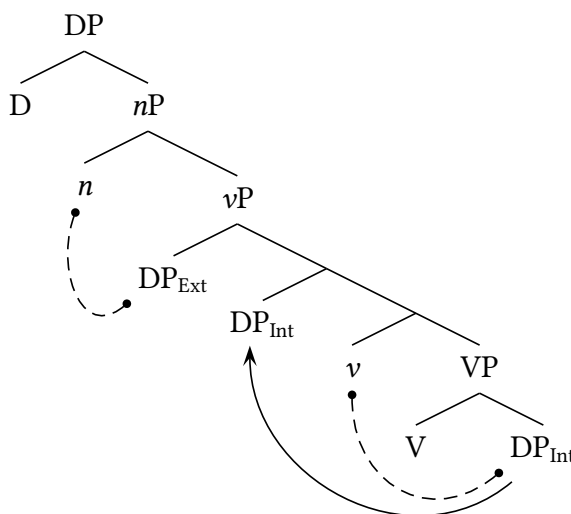

¹⁷In theory, nothing should prevent *-(C)ia/ina* from appearing in these clauses; however, this doesn't seem to be freely possible. I suggest that *-(C)ia/ina* may only be inserted as a last resort, similar to characterizations of Mayan Agent Focus (Ordóñez 1995; Coon et al. 2014; Assmann et al. 2015).

In sum, the fact that intransitives Agree with both Infl and v ensures that they can participate in composite \bar{A} -probing, and ensures that they do not lose licensing in non-finite contexts. Only ergatives, which Agree solely with Infl, will show these behaviors.

7.3.3 Challenges for inherent and configurational accounts

The structural ergative approach that I develop here builds on existing proposals, but two alternative approaches to ergative are more standardly used. The first proposes that ergative is an *inherent case*, assigned by the head that introduces the external argument (Woolford 1997, 2006; Aldridge 2004; Anand & Nevins 2006; Legate 2008b, 2012; Mahajan 2012); the second proposes that ergative is assigned *configurationally*, via a non-structural rule which evaluates the number of eligible DPs in the same domain (Marantz 1991; Baker 2014, 2015; Baker & Bobaljik 2017; Yuan 2022).

I show that these two standard approaches face challenges in accounting for the Nukuoro data. The inherent view fails to capture the pattern in non-finite clauses, where ergative arguments fail to be licensed in the absence of Infl; an inherent approach also struggles to capture the dependency between ergative assignment and properties of the object. Meanwhile, a configurational ergative view easily captures the dependent nature of ergative, but needs some revisions to capture the licensing facts in non-finite clauses. I outline how revisions to the nature of unmarked Case assignment could potentially capture the Nukuoro pattern.

7.3.3.1 Inherent approaches

Approaches that take ergative to be an inherent case assume that ergative is assigned via a specifier-head configuration by the same head that introduces the external argument, typically v (e.g., Woolford 1997, 2006; Legate 2004, 2008b). Inherent ergative accounts leave open different possibilities for absolutive assignment: perhaps all absolutive arguments are licensed by Infl (the ABS = NOM approach; Murasugi 1992; Bittner & Hale 1996a,b; Ura 2001; Legate 2008b), or perhaps absolutive is a morphological default Case (e.g., Legate 2008b), subsuming the Case value assigned by v to the transitive object (= ACC) and the Case value assigned by Infl to the transitive subject (= NOM).

The crucial claim of inherent ergative accounts is that ergatives are always licensed, simply by virtue of being introduced, hence its characterization as “inherent”. It is impossible to introduce a transitive external argument that lacks Case licensing, because Case is assigned by the same head that introduces it. Meanwhile, licensing for intransitive subjects—and potentially transitive objects as well—is dependent on the presence of Infl. As such, non-finite contexts should lead to a licensing failure for (at least some) absolutive arguments: intransitive subjects are predicted to lose licensing in non-finite contexts, and transitive objects may also lose licensing depending on the account.

These predictions are clearly at odds with what we find in Nukuoro non-finite clauses, making an inherent approach difficult to adopt. Ergative subjects in Nukuoro lose Case licensing in structurally-reduced clauses, meaning that ergatives cannot be licensed in situ by the same head

that introduces them—they must be licensed by higher functional structure. Furthermore, intransitive subjects and transitive objects never lose licensing in these contexts, showing that neither of these arguments is licensed by Infl. These contradictions alone paint an unattractive picture for the inherent approach in Nukuoro.

These licensing challenges arise in addition to known challenges for the inherent view with respect to the dependent nature of ergative. For example, in Nukuoro, external arguments of predicates that take two arguments behave like absolutes when the object is structurally non-canonical: for instance, if the object is an incorporated N^0 or couched within prepositional structure (i.e., middles). This generalization holds cross-linguistically as well, and can be seen in morphologically ergative languages like Samoan. In transitive clauses with two DP objects, the transitive subject is marked with ergative case (64a); when the object is an incorporated NP, however, the transitive subject cannot be ergative and instead receives absolutive case (64b).

(64) Samoan pseudo noun incorporation (Collins 2017:13)

- a. E [VP su'e pea] e le teine le ta'ifau ula.
 PRES search continuously ERG DET girl DET dog.ABS mischievous
 'The girl continuously searches for the mischievous dog.'
- b. E [VP su'e ta'ifau ula pea] (*e) le teine.
 PRES search dog mischievous continuously ERG DET girl.ABS
 'The girl continuously searches for mischievous dogs.'

The inherent view on its own does not account for behavior like in (64), since ergative assignment arises as a result of merging the transitive subject—this Case assignment should not be affected by behavior of the object. In order to derive the pattern in (64) on an inherent ergative view, one must encode an additional contingency between properties of the object and properties of v and/or the external argument. Tollan (2018), for instance, encodes such a contingency by proposing that external arguments may be introduced by a lower v head—which assigns no inherent Case value—or a higher, ergative-assigning Voice head, based on their semantic properties. In object incorporation clauses, she claims that the external argument always has the semantic properties of a “low” agent, and thus will be introduced by the lower v head which does not assign ergative Case.

The present view, on the other hand, captures the behavior under object incorporation with no further stipulation. Since absolutive Case is assigned by v to the most local accessible nominal, an incorporated object will not be a licit target for absolutive Case assignment. The probe on v will then undergo cyclic expansion to agree with the argument in its specifier, namely the external argument. The transitive subject of a clause with object incorporation thus receives exactly the same Case values as an intransitive subject: it will receive absolutive from v , followed by ergative from Infl. In languages with overt morphological case, the ergative impoverishment rule will apply at the interface with morphology, deleting the [ERG] feature on the external argument in the context of [ABS], resulting in absolutive morphology on the transitive subject.

7.3.3.2 Configurational approaches

Another possibility for ergative assignment comes from configurational theories of case, where case is assigned to a nominal only when there is another eligible nominal in the same domain (Yip et al. 1987; Marantz 1991; Baker 2015). On this view, case is assigned within particular domains by a set of configurational rules, which tell the algorithm what case value to assign, and whether it should be assigned to the higher or lower of two nominals. There is also an unmarked case, which is assigned to any nominal that remains caseless in that domain after all configurational rules apply. Crucially, functional heads are not directly responsible for Case assignment in configurational theories; functional structure is only relevant insofar as it delimits a Case assignment domain.

Configurational theories of ergative/absolutive case assignment have been developed for a number of languages, including Shipibo (Baker 2014), West Circassian (Ershova 2019), and Inuit languages (Yuan 2022), with some variation as to whether ergative is assigned to the higher or lower of two nominals. Ergative is assigned “upward” in languages which preserve the base-generated hierarchy of subject over object (e.g., Shipibo), while ergative is assigned “downward” in languages that move the object to a position higher than the transitive subject (e.g., West Circassian, Inuit). Two configurational ergative rules are provided in (65) and (66).

(65) *Upward assignment of ergative* (Baker 2014:343)

If there are two distinct argumental NPs in the same phase such that NP₁ c-commands NP₂, then value the case feature of NP₁ as ergative unless NP₂ has already been marked for case.

(66) *Downward assignment of ergative* (Yuan 2022:524)

Ergative case is dependent, assigned to the lower of two arguments in the vP-external domain.

After ergative Case has been assigned configurationally, any remaining argument in the same domain receives absolutive Case. Put another way, absolutive acts as a catch-all for any argument that has not been targeted by a more specific rule.

Unlike the inherent view, a configurational ergative analysis has no trouble accounting for the dependency between ergative assignment and properties of the object. On this style of account, ergative in Nukuoro would be assigned to the *higher* of two arguments in the vP-external domain, since objects do not undergo inversion in Nukuoro (as argued in Chapter 6). As a result, ergative Case would only be assigned to the transitive subject if the object moved to the (inner) specifier of vP, as schematized in (67).

(67)
$$\begin{array}{c} [{}_{vP} DP_{Subj} [DP_{Obj} [v [{}_{vP} V DP_{Obj}]]] \\ \uparrow \quad \uparrow \quad \uparrow \\ \text{-- ERG --} \end{array}$$

The main challenge for an off-the-shelf configurational theory concerns the nominal licensing behavior in non-finite clauses, where ergative licensing is clearly tied to the presence/absence of a functional head. On configurational approaches, functional structure like Infl does not actually

assign Case, but rather only serves to delimit Case domains. For this reason, ergative should be assigned in all clauses where the object acts as a valid competitor: assuming that objects move to Spec, vP in non-finite clauses, as they do in matrix clauses, ergative Case should continue to be assigned in non-finite contexts. Furthermore, there is always a Case that can be assigned to leftover nominals on configurational accounts: even if ergative were not assigned in non-finite clauses, transitive subjects and objects would both receive the unmarked Case, namely absolutive. The only way to implement a licensing failure on this view, then, would be to restrict the application of the unmarked Case.

The configurational approach becomes more tenable for Nukuoro if unmarked Cases are keyed to particular domains, just like configurational rules.¹⁸ For example, consider the possible configurational rules laid out in (68), where each domain is specified for the unmarked Case that it assigns.¹⁹

- (68) Possible configurational rules for Nukuoro
- a. *Domain delimited by v*
Assign ABS to any DP that does not have a Case value.
 - b. *Domain delimited by finite Infl*
Assign ERG to the higher of two DPs.
Assign ABS to any DP that does not have a Case value.

These rules capture the basic pattern of ergative assignment in the following ways. The rule in (68a) ensures that ABS will be assigned to internal arguments, which are base-generated below v . If the object undergoes shift to Spec, vP , the rule in (68b) allows ERG to be assigned to the higher external argument. If object shift does not occur—for instance, if there is no object, or if the object is incorporated—(68b) ensures that the external argument receives the unmarked Case within the IP domain, namely ABS.

In a non-finite clause, which lacks finite Infl, the two rules in (68b) fail to apply because the functional head that delimits the domain is absent. As a result, ergative Case cannot be assigned—*but neither can unmarked absolutive Case*. Thus, even though the object may shift to Spec, vP , no Case will be assigned to the external argument, resulting in a Case licensing failure. Since *-(C)ia/ina* realizes a flavor of v^0 , the addition of *-(C)ia/ina* rescues the derivation by introducing an additional v -domain that contains the external argument, providing an unmarked Case rule that assigns ABS to the transitive subject.

¹⁸An alternative way to get around this challenge is to divorce nominal licensing from Case assignment altogether; this is the route taken by Ershova (2019), for instance, who argues that nominal licensing in West Circassian is carried out via Agree, while Case assignment is handled configurationally. It would be possible to adopt a similar approach for Nukuoro: the ergative extraction restriction would refer to configurationally-assigned Case values, while the non-finite clause data would arise as a result of nominal licensing mechanisms. However, this approach misses a key connection between the extraction restriction and the non-finite clause facts, namely that they share the same *-(C)ia/ina* repair. If Case and nominal licensing are two independent mechanisms, it is unclear why the same morphology would salvage a Case-licensing issue as well as a licensing issue.

¹⁹Note that this machinery is independently useful to ensure that verbal domains and nominal domains assign different unmarked Cases, namely ABS/NOM vs. GEN (Marantz 1991:24, Baker 2015, ch. 4).

These modifications aside, I adopt a structural view of Case assignment in this dissertation to maintain a straightforward connection between nominal licensing and functional structure. However, it's important to note that with small changes to unmarked Case assignment, a configurational Case assignment mechanism could be adapted to capture the Nukuoro pattern.

7.4 Extensions and predictions of the account

As the previous section shows, the flexible intransitive account captures the syntactic correlates of Case in Nukuoro, namely the extraction and non-finite clause behavior. Unfortunately, Nukuoro does not show morphological evidence for case or agreement, meaning that the more specific predictions of the flexible intransitive account cannot be tested. To do this, we can extend the account to a wider range of languages and develop a set of predictions for what morphological patterns we can and cannot account for.

I discuss two classes of extensions and predictions here. First, the flexible intransitive approach does well in accounting for mixed alignment systems (i.e., “splits”), where languages show some behavior that is nominatively-aligned and other behavior that is ergatively-aligned. I discuss implications for morphological splits first, outlining predictions for the realization of case and agreement on the present account. Next, I discuss the implications for syntactic splits: instances where the syntactic behavior of a language does not align with its morphological case system. The flexible intransitive account predicts that both morphologically ergative and accusative languages should show syntactic splits, a prediction that does not align with established typological patterns (e.g., Anderson 1976, 1977; Dixon 1994; Coon et al. 2017). Nevertheless, I provide some reason to suspect that the typology of splits is more varied than has previously been claimed. Finally, I show that the account neatly captures instances of multiple case assignment and generates some predictions for case “overwriting” effects, showing that additional machinery is needed to capture overwriting patterns on more traditional Case theories as well.

Ergative systems are known to be quite heterogeneous, with a wide range of patterns and behaviors associated with them cross-linguistically (Johns 2000; Bittner & Hale 1996b,a; Deal 2015a). For this reason, I maintain that the flexible intransitive account is just one of the many ways to derive an ergative system, which can coexist alongside alternative ergative Case mechanisms in other languages. With that said, one of the advantages of the flexible intransitive approach is that it can capture a range of empirical patterns with a few basic parameters, which I discuss below.

7.4.1 Morphological splits

In the previous section, I have outlined the possibility that impoverishment rules may apply to nominals that possess two Case features, namely intransitive subjects. These impoverishment rules are reproduced in (69).

(69) Case impoverishment rules

- a. *Morphologically ergative systems*: [Infl] → ∅ / __[v]
 b. *Morphologically accusative systems*: [v] → ∅ / __[Infl]

Crucially, given the rules in (69), the phi-features of the intransitive subject that have been copied back to Infl and *v* are *not* targeted by impoverishment: these features survive into the morphological component and may be realized as agreement, even if their corresponding category feature has been impoverished on the nominal goal. Concretely, this means that morphological case and agreement may show different alignments: one system could be ergative/absolute, even if the other is nominative/accusative.

This is a welcome prediction for ergative languages, which are well-known to show morphological splits of this type (Anderson 1977; Dixon 1994; Johns 2000; Coon et al. 2017). Languages with morphological ergative case often show nominative/accusative agreement. Such is the case in Warlpiri (Pama-Nyungan), for instance, which marks overt ergative case but shows agreement with all subjects (70).

(70) Warlpiri ERG/ABS case and NOM/ACC agreement (Hale 1983:18)

- a. Ngaju ka-**rna** wangka-mi
 1 PRS-1SBJ speak-IPFV
 'I am speaking.'
- b. Ngaju-**rlu** ka-**rna**-ngku nyuntu nya-nyi
 1-ERG PRS-1SBJ-2OBJ 2 see-IPFV
 'I see you.'

We also find splits in the kinds of arguments that participate in different alignments. For instance, nominal arguments in Dyirbal typically show ergative/absolute case marking, while pronouns are marked for nominative/accusative case (71).

(71) Dyirbal ERG/ABS case, but NOM/ACC pronouns (Legate 2008a:7)

- a. **ngadya** nyinanyu
 1.NOM sit.NFUT
 'I sat down.'
- b. **ngadya** bayi yaɾa balgan
 1.NOM NC1.there.ABS man.ABS hit.NFUT
 'I hit the man.'
- c. ngayguna banggul yaɾa-**nggu** balgan
 1.ACC NC1.there.ERG man-ERG hit.NFUT
 '(A/the) man is hitting me.'

Both kinds of patterns can be derived straightforwardly on the flexible intransitive account. In languages like Warlpiri, where case is ergatively-aligned but agreement is accusative, there is a mismatch between the intransitive impoverishment rule, which deletes the [Infl] feature on the

intransitive subject (72), and agreement morphology, which only realizes the phi features of the intransitive subject on Infl. The configuration which leads to this kind of mismatch is schematized in (74), where only the phi features on Infl are realized.²⁰

(72) Warlpiri impoverishment rules
[Infl] → ∅ / [v]

(73) Warlpiri vocabulary items
[v] / [D] ↔ -∅
[Infl] / [D] ↔ -*rlu*
[SPKR] / [Infl] ↔ -*rna*
[ADDR] / [v] ↔ -*ngku*

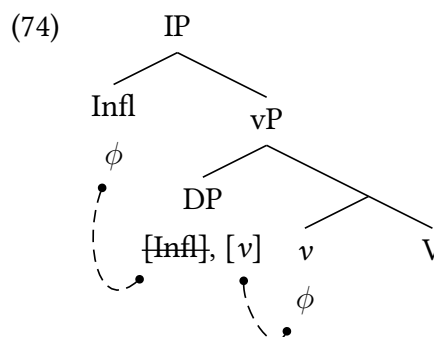

The realization of case morphology is determined by the first two rules in (73): in the context of [D] (i.e., on a DP), a [v] feature is realized by a null affix, meaning that absolutive arguments are unmarked, and [Infl] is realized by the suffix *-rlu*, which marks only ergatives. Agreement morphology then realizes phi features found on Infl and v, resulting in subject and object agreement, respectively. For example, the last two rules in (73) determine the verbal agreement found in the transitive clause in (70): the suffix *-rna* realizes the [SPKR] feature of the subject that has been copied to Infl, while the suffix *-ngku* realizes the [ADDR] feature of the object that has been copied to v.

The type of case split found in Dyrirbal, on the other hand, can be captured via conditions on impoverishment: there are two impoverishment rules, one for pronouns and one for all other nominals.²¹ The first impoverishment rule deletes [v] in the context of [Infl] as well as a feature specific to pronouns, such as a syntactically-represented index feature (Idx; e.g., Hanink 2021; Jenks & Konate 2022) (75a); the second rule applies in all other instances, deleting [Infl] in the context of a [v] feature (75b).

²⁰In order to prevent multiple instances of agreement with the intransitive subject (e.g., one on Infl and one on v), there must be a more global calculation of agreement exponence. In Warlpiri, I suggest that the higher instance of the subject's phi features is realized on Infl, rather than the lower instance on v. This perhaps parallels mechanisms of chain reduction (e.g., Nunes 2004), which also prioritize pronunciation of the higher of two identical sets of features.

²¹In a way, this analysis is not unlike what Legate (2008a, 2012) proposes for Dyrirbal, which she argues is underlyingly tripartite, assigning abstract NOM, ACC, and ERG. For her, pronouns show syncretism for NOM and ERG, resulting in a nominative morphological alignment; all other nominals show syncretism for NOM and ACC, resulting in an absolutive morphological alignment. The Case assignment mechanism I propose could also be seen as a kind of underlying tripartite alignment, differentiating nominals that receive only [v], only [Infl], and both [v] and [Infl]. The impoverishment rules accomplish a similar goal as Legate's syncretism by deleting different features on different kinds of intransitive subjects; these different types of impoverishment allow the intransitive subject to pattern either with the transitive subject (surface NOM-ACC) or with the transitive object (surface ERG-ABS).

(75) Dyirbal impoverishment rules

- a. *Pronouns*: $[v] \rightarrow \emptyset / _ [Infl, Idx]$
 b. *Other nominals*: $[Infl] \rightarrow \emptyset / _ [v]$

As a result of this impoverishment, intransitive subject pronouns will be left with only an [Infl] feature, grouping them with transitive subject pronouns, which also Agree with Infl. Meanwhile, intransitive subject full nominals will be left with only a [v] feature, grouping them with transitive object pronouns, which agree with *v*. These two rules result in a morphological case split between pronouns and other nominals without changing the underlying syntax or agreement configurations for these nominals.

Interestingly, the flexible intransitive account allows for splits not just in ergative languages, but also in accusative languages. Morphological splits in nominative/accusative languages have been claimed not to exist: Anderson (1977) famously generalized that there are no languages which show nominative behavior in case marking but ergativity in agreement. However, it is worth noting that there are known exceptions to Anderson's generalization (e.g., Moravcsik 1978). To cite one example, Patel (2007) notes that in Kutchi Gujarati past perfectives, verbal agreement has an ergative alignment, only targeting intransitive subjects and transitive objects; case marking is nominative-accusative, with overt accusative marking on transitive objects and unmarked nominative subjects (76).²²

(76) Kutchi Gujarati NOM/ACC case and ERG/ABS agreement (Patel 2007)

- a. Reena aav-**i**.
 Reena.NOM came-F.SG
 'Reena came.'
- b. Reena chokra-**ne** mar-**ya**.
 Reena.NOM boys-ACC hit-PFV.M.PL
 'Reena hit the boys.'

The pattern instantiated by Kutchi Gujarati, where case marking is nominative/accusative but agreement is ergative/absolute, is just as easily derived as the reverse pattern found in Warlpiri. This time, it is the [v] feature which is impoverished on the intransitive subject, leaving only an [Infl] feature and allowing intransitive subjects to pattern with transitive subjects. However, the phi features of the intransitive subject are still realized on *v*, as schematized in (79), leading to an absolute agreement pattern.

²²Bobaljik & Harley (2017) argues that case marking on the object in (76b) is an instance of differential object marking (DOM), which should not be considered true accusative case. However, I note that there are many analyses of DOM which *do* characterize this marking as accusative case, whose assignment or realization is dependent on other features of the object (e.g., Baker & Vinokurova 2010). On the view put forth here, accusative agreement in Kutchi Gujarati would only be realized if the object also carried a particular feature such as [SPECIFIC] or [DEFINITE].

(77) Kutchi Gujarati impoverishment rules
 $[v] \rightarrow \emptyset / _ [Infl]$

(78) Kutchi Gujarati vocabulary items
 $[Infl] / _ [D] \leftrightarrow -\emptyset$
 $[v] / _ [D] \leftrightarrow -ne$
 $[F, SG] / _ [v] \leftrightarrow -i$

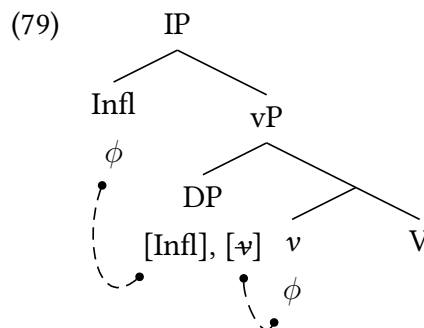

As a result, intransitive subjects pattern like transitive subjects for the purposes of case morphology, but agreement with v will index intransitive subjects and transitive objects.

The fact that intransitive subjects agree with both Infl and v generates one additional prediction: in principle, intransitive subjects should be able to show two instances of agreement morphology on the verb. One potential example of dual intransitive agreement is described by Bobaljik & Wurmbrand (2002) in Itelmen (Chukotko-Kamchatkan), where intransitive subjects control both prefixal and suffixal agreement (80a). In transitive clauses, prefixal agreement indexes features of the transitive subject, while suffixal agreement often indexes features of the transitive object (80b).²³

(80) Double agreement with intransitive subjects in Itelmen

a. kma t-k'ot-kičen

I 1SG-come-1SG.SUB

'I came/arrived.'

(Bobaljik & Wurmbrand 2002:6)

b. kma t'-əlčqu-[y]in

I 1SG-see-2SG.OBJ

'I saw you.'

(Bobaljik & Wurmbrand 2002:6)

Assuming that prefixal agreement reflects Agree with Infl, while suffixal agreement reflects Agree with v , the fact that intransitive subjects control both slots suggests that they enter into dependencies with both heads, as the present account proposes.

Aside from this example, it seems like languages where intransitive subjects systematically control two agreement slots are somewhat rare. One reason these systems might be rare is due to transitivity flagging: if intransitive subjects always agreed twice, it would be harder to distinguish between intransitive and transitive verbs. This would be especially true in languages with *pro*-drop, where agreement can be the only overt exponent of an argument. Another reason would be to reduce redundancy: obviously agreement introduces redundancy, allowing key features of arguments to be more recoverable, but perhaps two instances of redundancy is dispreferred given competing constraints on economy.

²³Suffixal agreement may also index a combination of subject and object features when the object is third person. This fact can easily be understood in the present framework if third person arguments Agree but fail to satisfy the probe responsible for suffixal agreement (i.e. v), resulting in a second instance of Agree with the transitive subject.

7.4.2 Syntactic splits

In addition to morphological splits, the flexible intransitive account makes similar predictions for syntactic splits. The crucial claim of the present analysis is that intransitive subjects receive two Case values in the narrow syntax, one from Infl and one from *v*; Case impoverishment applies later, at the interface with morphology. As a result of being involved in two A-dependencies, intransitive subjects should be able to show syntactic behavior associated with either Case within a single language, even if they only show the morphological form of one.

It is clear from the typological literature that this is the case for morphologically ergative languages: nearly every ergative language shows some syntactic behavior that is nominatively-oriented (Anderson 1976; Dixon 1994). For instance, many ergative languages show a nominative pattern of raising or control (e.g., Basque; Ortiz de Urbina 1989; Oyharçabal 1992); others show nominative behavior in A-dependencies within a single clause, such as clitic formation in Tongan (Otsuka 2000, 2002). Pre-verbal pronominal clitics in Tongan may be used for intransitive and transitive subjects, but objects may not cliticize to the same position (81).

(81) Nominative clitic pronouns in Tongan

- a. Na'a **ku** kata.
PST 1SG laugh
'I laughed.'
- b. Na'a **ku** langa 'a e fale.
PST 1SG build ABS REF house
'I built a house.'
- c. *Na'a **ku** taa'i 'e Sione.
PST 1SG hit ERG John
Intended: 'John hit me.'

(Otsuka 2010a:319)

Some nominative patterns could simply arise due to the relative structural positions of subject and object: if subjects remain higher than objects (i.e., if there is no object inversion), they would be targeted by operations that are sensitive to locality, regardless of the mechanism of ergative assignment. However, other patterns are clearly tied to Agree with Infl: in Tongan, for instance, pronominal subject clitics are argued to occupy Spec,TP (Otsuka 2000, 2002). These kinds of patterns are straightforwardly derived on the flexible intransitive account, where all subjects Agree with Infl regardless of the morphological case they show.

In a similar way, the present account also allows for syntactic splits in morphologically accusative languages: since intransitive subjects always agree with *v*, we could, in principle, find instances of syntactic ergativity in languages with nominative-accusative case. This combination of properties has been argued to be unattested: it is often claimed that syntactic ergativity is limited to languages that have morphological ergative case (Dixon 1994:172).

While Dixon's generalization holds in many languages, it is not universal: there are documented cases of syntactic ergativity with a nominative-accusative case system, as predicted by the flexible intransitive account. Donohue & Brown (1999) describe Oirata as a counterexample, an SOV Austronesian language spoken in Indonesia. Oirata uses a marked nominative case

system, where nominative is marked only on pronouns using the suffix *-te* and accusative case is generally unmarked, aside from the 1st person singular (82). Full nominal arguments in the language show no case marking, and verbs do not index person or number of any arguments.

(82) Nominative/accusative alignment in Oirata (Donohue & Brown 1999:66–67)

- a. Woina'a in-**te** Ahum na'a ma'u.
 yesterday 1PL.EX-NOM Ambon OBL come
 'We arrived from Ambon yesterday.'
- b. Ee-**te** in asi-ho.
 2SG.POL-NOM 1PL.EXCL see-NEG
 'You didn't see us.'

Despite having morphological nominative case, Oirata also shows an ergative extraction restriction in relativization: intransitive subjects (83a) and transitive objects (83b) may act as the head of a relative clause, while transitive subjects (83c) may not.

(83) Ergative extraction restriction in Oirata (Donohue & Brown 1999:68–69)

- a. In-te ihar [____S mara-n] asi
 1PL.EX-NOM dog go-REL see
 'We saw the dog that had left.'
- b. Ihar [in-te ____O asi-n] tipare.
 dog 1PL.EX-NOM see-REL flee
 'The dog that we saw fled.'
- c. *Ihar [____A ani asi-n] mara.
 dog 1SG.ACC see-REL go
 Intended: 'The dog that saw me left.'

The Oirata pattern can easily be derived on the flexible intransitive system: relativization is sensitive to [*v*] features, deriving an absolutive-only pattern of relativization, but [Infl] is realized on all subjects, yielding morphological nominative case.

In a similar vein, the flexible intransitive approach predicts that a language could show an accusative morphological alignment, but an ergative licensing pattern in non-finite clauses. This is because intransitive subjects, which usually show morphology from Infl, would continue to agree with *v* in non-finite clauses; as a result, non-finite contexts will fail to license transitive subjects, and intransitive subjects will show the same morphology as transitive objects, realizing their shared [*v*] feature. As far as I know, there is no documented language where this has been argued to be the case.

One phenomenon that may be related to this prediction is the connection between ergativity and nominalization (e.g., Johns 1992; Alexiadou 2001, 2017; Salanova 2007; Imanishi 2014), which holds even in languages that are not ergative elsewhere in their grammar. Consider the pattern found in Greek nominalizations, for instance. Intransitive subjects, whether unaccusative or unergative, receive genitive marking in nominalizations, as shown in (84a) and (84b), respectively. Transitive objects are also marked using the genitive; by contrast, transitive subjects

appear within a prepositional *by*-phrase, the same prepositional structure which is used to introduced demoted agents of passives (84c).

(84) Ergativity in Greek nominalization (Alexiadou 2017: 356)

- a. *i afiksi ton pedion*
the arrive the children.GEN
'the arrival of the children'
- b. *to treksimo tu athliti*
the running the athlete.GEN
'the running of the athlete'
- c. *i katastrofi tis polis* [_{PP} *apo tus varvarus*] *mesa se tris meres*
the destruction the city.GEN by the barbarians within three days
'the destruction of the city by the barbarians within three days'

In other words, case marking in these nominalizations shows an ergative alignment: genitive case is limited to intransitive subjects and transitive objects, while transitive subjects appear in a prepositional structure. This behavior appears in a number of languages which are otherwise nominative-accusative, including Greek, English, and a number of Romance languages; for an overview of these effects, see Alexiadou (2001) and Alexiadou (2017).

Nominalizations may be one context that shows exactly the kind of syntactic split that is predicted on the flexible intransitive account, particularly since nominalizations generally lack Infl. In this light, one could argue that transitive subjects appear within prepositional structure in (84) as a repair for a licensing failure due to the absence of Infl, while other arguments, including intransitive subjects, are licensed by Agree with *v*. In fact, Coon & Salanova (2009) argue that ergativity in nominalizations results from the separation of the nominalized predicate from Infl. However, Alexiadou (2017) points out that cross-linguistically, only a subset of nominalizations show an ergative pattern: other nominalizations, including some which lack Infl, show a nominative-accusative pattern. In order to attribute ergativity in nominalizations to the absence of Infl, one would need to show that nominatively-aligned nominalizations include Case-assigning functional structure that ergatively-aligned nominalizations do not.

7.4.3 Multiple case assignment and “overwriting” effects

A final prediction of the flexible intransitive account concerns multiple case assignment. On the current view, intransitive arguments systematically receive two Case values; this configuration is permitted on a view of Case assignment as bidirectional feature exchange, but challenging for the more traditional view of Case assignment as feature valuation and deletion (e.g., Chomsky 1995, 2000, 2001). The idea that a single nominal may receive two Case values has precedent elsewhere, such as in “case stacking” phenomena, where two case values are realized on the same nominal (McCreight 1988; Nordlinger 1998; Merchant 2006; Richards 2013; Pesetsky 2014; Assmann et al. 2014), “multiple case assignment” phenomena, where two copies of a single movement chain receive different case values (Bejar & Massam 1999; Polinsky & Potsdam 2002), and theories which

implement Case as the realization of agreement with multiple functional heads (Deal 2010; Clem 2019). The fact that intransitive subjects receive multiple Case values on the present account is not a drawback of the account, but rather an extension of a known phenomenon.

The intransitive impoverishment account makes an additional prediction concerning case overwriting effects, which occur when a nominal that has received multiple Case values over the course of the derivation only shows the morphology of one (e.g., Bejar & Massam 1999). Due to the nature of impoverishment, the current account predicts that case overwriting will only proceed in one direction: the more marked case can be “overwritten” by the unmarked case, but an unmarked case can never be overwritten. In ergative and accusative systems, this yields the following two concrete predictions (85):

- (85) Predictions for Case “overwriting”
- a. $ERG \rightarrow ABS$, but $*ABS \rightarrow ERG$
 - b. $ACC \rightarrow NOM$, but $*NOM \rightarrow ACC$

To see why these predictions hold, let us revisit the impoverishment rule that applies in morphologically ergative languages. The ergative/absolutive impoverishment rule states that if a single nominal carries features from both [Infl] and [*v*], the [Infl] feature will be deleted, yielding only [*v*]. This rule ensures that intransitive subjects end up being morphologically absolutive, despite agreeing with both functional heads. However, this rule will also apply to nominals that agree with both [Infl] and [*v*] as a result of cross-clausal movement: [Infl] will always be impoverished on these nominals, meaning that all nominals that have undergone multiple Case assignment will be marked absolutive.

We can observe that the positive half of the prediction is borne out, namely that arguments should be able to receive a marked Case first (e.g., ergative) followed by an unmarked Case (e.g., absolutive). Raising from ergative to absolutive is attested in Niuean, for instance (86).

- (86) Niuean raising from ergative to absolutive
- a. Teitei [ke fakatau **e** **Sione** taha fale].
 nearly SBJV buy ERG Sione one house
 ‘It nearly happened that Sione bought a house.’
 - b. Teitei **a** **Sione**_i [ke fakatau *t*_i taha fale].
 nearly ABS Sione SBJV buy one house
 ‘Sione nearly bought a house.’

(Bejar & Massam 1999:72)

The negative half of the prediction—that arguments should not be able to gain a more marked Case via movement—is harder to test. In ergative languages, for instance, raising from absolutive to ergative may be ruled out independently via constraints on the locality of A-movement: cross-clausal raising to an ergative-marked position may not be possible over, say, an intervening absolutive argument. In accusative languages, where raising from nominative to accusative would be sufficiently local, clausal boundaries and finiteness introduce a different confound: in many languages, raising to object is only possible from non-finite clauses, where finite Infl is absent and nominative would not be assigned. Canonical raising, then, would not actually involve

any case overwriting effects: the raised nominal would only receive accusative Case in the higher position.

The clearest instance of raising to a marked Case position is found in hyperraising to object constructions, where an argument raises from the nominative-marked position of a finite embedded clause to an accusative-marked position of the matrix clause. Zyman (2017) describes such a construction in P'urhepecha (87); note that nominative case in P'urhepecha is unmarked.

(87) P'urhepecha hyperraising from nominative to accusative

- a. Ueka-sin-ø-di=sī [eska **Xumo** u-a-ø-ka ma k'umanchikua].
 want-HAB-PRS-IND3=pS that Xumo make-FUT-PRS-SBJV a house
 'They want Xumo to build a house.'
- b. Ueka-sin-ø-di=sī **Xumu-ni** [eska u-a-ø-ka ma k'umanchikua].
 want-HAB-PRS-IND3=pS Xumo-ACC that make-FUT-PRS-SBJV a house
 'They want Xumo to build a house.' (Zyman 2017:2)

On the present account, it is impossible to derive accusative case marking on the raised argument without additional machinery: the nominal has agreed with Infl in the embedded clause, which yields nominative case in (87a); if the same nominal were then to agree with *v* in the matrix clause, the presence of both category features should trigger the accusative impoverishment rule, deleting [*v*] and bleeding the possibility of accusative case realization.

How can we account for this? The generalization appears to be that nominals show the Case that they receive in their pronounced position. For instance, Polinsky & Potsdam (2002) describe an instance of backward control in Tsez, where the lower copy of a movement chain is pronounced, rather than the higher copy. Since agreement is limited to absolutive arguments in Tsez, the higher copy of the argument in the matrix clause is shown to be absolutive based on its ability to agree with the matrix verb *y-oq-si* 'II-begin-PAST.EVID'; despite the higher copy being absolutive, the lower pronounced copy of the nominal shows ergative morphology, reflecting its ergative status in the embedded clause (88).

- (88) <kid>_i [**kid-bā**_i ziya b-išr-a] y-oq-si
 girl.II.ABS girl.II-ERG COW.II.ABS III-feed-INF II-begin-PAST.EVID
 'The girl began to feed the cow.' (Polinsky & Potsdam 2002: 248)

Any theory of Case thus needs to explain the effect of pronunciation position on case realization. One way to do this would be to say that nominals "shed" their case features upon moving across clauses (e.g., Bejar & Massam 1999), resulting in an entirely new set of dependencies in the higher clause. Alternatively, we could propose that morphological realization is domain-specific: a case value may only be pronounced if its Case assigner is in the same clause. However this phenomenon is accounted for, it seems to require additional explanation for all Case mechanisms, including the flexible intransitive account.

7.5 Conclusion

In this chapter, I have demonstrated that Nukuoro lacks morphological ergative case and agreement, yet shows syntactic correlates of ergative Case in non-finite clauses as well as extraction. The Nukuoro data thus supports a theory where Case is syntactically represented (i.e., abstract Case) and obligatory on nominals (i.e., the Case Filter). In this way, Nukuoro provides evidence against accounts which argue that case is a purely morphological phenomenon (e.g., Marantz 1991; McFadden 2004; Landau 2006b), or that Case is not present if it is not morphologically realized (Harford Perez 1985; Markman 2009; Diercks 2012). Instead, Nukuoro supports a view where all languages have abstract Case distinctions, even if they do not mark these distinctions through head or dependent marking (e.g., van der Wal 2015; Halpert 2016; Sheehan & van der Wal 2016; Sheehan & van der Wal 2018).

Within this literature, Nukuoro constitutes a novel example of a language with abstract *ergative* Case without morphological case, suggesting that languages with fully covert Case systems can show the same alignment distinctions that are found in languages with morphological case. In this way, I argue that licensing failures as a phenomenon should be implemented in terms of abstract Case, rather than more general, non-Case mechanisms (cf. Levin 2015; Sheehan & van der Wal 2016). Additionally, I note that accounts which attempt to reduce the scope of the Case Filter to structurally reduced nominals, such as Levin (2015), fail to capture the licensing behavior found in Nukuoro non-finite clauses.

The Nukuoro pattern highlights the connection between (syntactic) ergativity and licensing in non-finite clauses, which use the same *-(C)ia/ina* morphology. While non-finite contexts in other ergative languages appear to lack absolutive licensing, suggesting that absolutive Case is assigned by Infl (e.g., Dixon 1972; Coon et al. 2014), Nukuoro non-finite clauses clearly lack ergative licensing, warranting an account where ergative is assigned by Infl (Levin & Massam 1985; Bobaljik 1993; Laka 1993; Otsuka 2000; Rezac et al. 2014). This model contrasts with other, more widely-adopted theories of ergative Case assignment, namely that ergative is an inherent Case (Woolford 1997, 2006; Aldridge 2004; Anand & Nevins 2006; Legate 2008b, 2012; Mahajan 2012) or that ergative is a configurational Case (Marantz 1991; Baker 2014, 2015; Baker & Bobaljik 2017; Yuan 2022); I showed in section 7.3.3 that neither of these alternative accounts sufficiently capture the Nukuoro pattern. I take variation in this domain to be indicative of the heterogeneity of ergative systems in general, which suggest that no single analysis of ergative Case assignment will be able capture all ergative systems.

The account that I develop for Nukuoro maintains the insight that ergative Case is assigned by Infl, but does so without imposing a transitivity condition on Case assignment (e.g., Levin & Massam 1985; Bobaljik 1993; Legate 2008b). The result is a system where intransitive arguments undergo agreement with both *v* and Infl, effectively receiving two Case values and allowing both of these Case relationships to be expressed simultaneously, even within the same language. Combined with the possibility of morphological impoverishment (e.g., Halle & Marantz 1993; Bonet 1991; Noyer 1992), a flexible intransitive account can capture a wide range of morphological case and agreement patterns, as demonstrated in section 7.4. On a broader level, the proposed theory of Case assignment demonstrates the versatility of characterizing Agree as bidirectional feature

exchange (Pesetsky & Torrego 2001; Deal To appear) and in turn, reformulating Case as agreement with one or more functional heads (Deal 2010; Clem 2019).

Chapter 8

Conclusion

This dissertation has explored clause structural mechanisms and theories of case and movement through the lens of Nukuoro. First, I provided an in-depth study of the grammar and clause structure of Nukuoro, including an analysis of matrix and relative clause structure. Building on this foundation, I then investigated aspects of Nukuoro ergativity, including an ergative extraction restriction and abstract ergative Case licensing, and brought these phenomena to bear on theories of movement restrictions and Case assignment. Here, I summarize the empirical, areal, and typological contributions of this work, followed by the broader implications of this case study for theories of clause structure, case, and syntactic ergativity.

8.1 Empirical, areal, and typological contributions

8.1.1 Nukuoro documentation and revitalization

The Polynesian Outlier languages are endangered and understudied, and Nukuoro is no exception. Aside from my own research on the language (Drummond 2016, 2022a, To appear; Drummond et al. 2019; Drummond & Rudolph 2021), documentation of the Nukuoro language prior to this dissertation was limited to several word lists (Christian 1898; Kubary 1900; Jeschke 1913; Elbert 1946) a Nukuoro-English lexicon (Carroll & Soulik 1973), a cursory description of Nukuoro phonology and morphology (Carroll 1965a), a translated Nukuoro narrative (Carroll 1965b), and a book of monolingual Nukuoro narratives (Carroll 1980). The overview of Nukuoro grammar in Chapter 3 thus provides novel description of many aspects of Nukuoro syntax, supplemented by description and analysis of more specific clause structural and ergative properties throughout the dissertation. The appendices to this dissertation also include 14 glossed and translated Nukuoro narratives, which allow for deeper study of Nukuoro grammar, discourse, culture, and mythology.

Additionally, Chapter 2 provides a guide to existing work on Nukuoro and a description of the methodologies of language documentation and revitalization that collaborators and I have undertaken over the past eight years. This description aims to provide a certain transparency about

the information presented throughout the dissertation, but it also aims to demonstrate how the scope of the current project goes well beyond language documentation and analysis, encompassing cultural documentation, repatriation of legacy materials, language resource development, and community events. These tasks have not been unrelated to linguistic documentation: in fact, there are many linguistic domains that we have only been able to document through these other areas, including lexical domains related to the environment and material culture, but also certain discursive domains, such as mnemonic chant. But also, these are areas that have been identified by community members as the primary needs of a documentation project, and which benefit Nukuoro people most directly. While the linguistic documentation and analysis will primarily be used by academics, these other products of my research provide usable tools for community members to engage with their culture and language.

8.1.2 Polynesian syntax

The description and analysis of Nukuoro clause structure and ergativity in this dissertation increases our understanding of the syntax of Polynesian languages more broadly. In Chapter 4, I provided an in-depth look at the derivation of SVO order in a language family that is largely verb-initial. I have shown that while other Polynesian languages require unmarked pre-verbal elements to be topical, Nukuoro pre-verbal elements do not require a topical interpretation and thus have undergone full reanalysis as subjects, as predicted by Chung (1978). Despite having a different basic word order, it is clear from the investigation in Chapter 4 that Nukuoro shares key phenomena with other Polynesian languages, such as object shift and predicate fronting. Further research on other Polynesian Outlier languages may reveal similar word order derivations, although it is likely that the other Outliers show different degrees of reanalysis of pre-verbal elements, as suggested by Drummond (2022a). Additional description of these phenomena will shed light on the historical development of SVO order in the Outliers, which will expand our understanding of word order change more broadly.

The description of Nukuoro ergative extraction in Chapter 6 demonstrates another instance of syntactic ergativity in Polynesian, in addition to the well-known ergative extraction restriction in Tongan (Otsuka 2000, 2006, 2010a; Clemens & Tollan 2021). While Tongan ergative extraction requires a resumptive pronoun to appear in subject position, Nukuoro ergative extraction requires the verbal morphology *-(C)ia/ina*. These two types of syntactic ergativity are found elsewhere in Polynesian as well: the resumptive type is also found in Tokelauan (Hooper 1993) and the *-(C)ia* type is also found in Samoan (Mosel & Hovdhaugen 1992; Collins 2013; Muāgututi'a 2018; Hopperdietzel 2020). The case discrimination account that I propose aligns with Otsuka's (2006; 2010a) analysis of the Tongan pattern, suggesting that a unified analyses of the resumptive and *-(C)ia* types may be possible; however, other authors have proposed contradicting accounts as well, with Clemens & Tollan (2021) attributing Tongan syntactic ergativity to object inversion and Hopperdietzel (2020) attributing Samoan syntactic ergativity to the prepositional nature of ergative (Polinsky 2016). This wide range of accounts for syntactic ergativity within a single language family (compared to the largely unified accounts of syntactic ergativity in Mayan, for

instance) suggests that further study of Polynesian languages may shed new light on the causes and implications of syntactically ergative patterns.

8.1.3 Ergative typology

Nukuoro shows several unusual combinations of properties, which bear on theories of ergative typology. As I showed in Chapters 6 and 7, Nukuoro shows ergative properties in the absence of morphological case marking. This combination is interesting in two respects. First, Nukuoro provides a clear case of syntactic ergativity without morphological ergativity, which was claimed to be unattested by Dixon (1994) and has since been reproduced in various typological overviews of ergativity (Johns 2000; Deal 2016b; Polinsky 2017b; Coon et al. 2017). With the addition of Nukuoro to the typology, there is no longer a need to posit a direct relationship between syntactic operations and morphological forms; I propose instead that this correlation is mediated via abstract ergative alignment, which often yields ergative morphology but may also exist independently of morphological realization. In this vein, Nukuoro also provides evidence that abstract ergative Case relationships may exist in the absence of ergative morphology, complementing the many examples of languages that show abstract nominative Case without morphological case (e.g., Sheehan & van der Wal 2016).

Nukuoro also provides a counterexample to the well-known generalization by Mahajan (1994, 1997) that ergative languages do not exhibit verb-medial orders (e.g., SVO). Several authors, including Mahajan, have attempted to derive this correlation via mechanisms of case assignment and movement (Bittner & Hale 1996b; Lahne 2008); however, the Nukuoro system shows that SVO orders are derivable even in the context of ergative Case assignment. Interestingly, though, there is a way in which Nukuoro does abide by Mahajan's generalization: until the final step of subject movement to Spec,CP, which is completely unrelated to Case assignment, the language otherwise has the clausal derivation of a VSO language. If Mahajan's generalization could be explained by the mechanisms involved in the creation of a verb-initial clause, rather than the final surface word order, Nukuoro would no longer pose a challenge to this generalization.

8.2 Theoretical implications

8.2.1 Clause structure

Chapters 4 and 5 investigated the clause structure of Nukuoro, including the structure of matrix clauses as well as the structure of genitive relative clauses. The mechanisms at play in the derivations of these clauses shed light on word order derivation, the division of labor between C and Infl, and the appearance of genitive case in clausal environments.

Chapter 4 argued that SVO order in Nukuoro does not simply reflect the base-generated order of arguments, but rather is derived via three steps of movement: movement of the object to Spec,vP, predicate fronting to a clause-medial position, and movement of the subject to Spec,CP. In this way, Nukuoro SVO is derived using a mechanism typically proposed for the derivation of

verb-initial languages; while verb-initial orders do appear in structurally reduced contexts in the language, Nukuoro (along with Imere; van Urk 2022) demonstrates that predicate fronting can appear in SVO clauses as well.

One of the key claims of Chapter 4 is that Nukuoro pre-verbal subjects occupy Spec,CP, a position which is canonically associated with \bar{A} -elements. Unlike other examples of A-movement to Spec,CP (e.g., van Urk 2015; Colley & Privoznov 2020; Gong 2022; Jenks 2023), Nukuoro subject movement does not have any clear hallmarks of \bar{A} -movement, suggesting that CP can be a subject position without being tied to \bar{A} phenomena. Subject movement to Spec,CP is especially unusual given the proposal in Chapter 7 that ergative Case is assigned by Infl; this proposal contrasts with standard models of Case assignment from Infl, which propose that the same Agree relation underlies subject movement and Case assignment (e.g., Chomsky 2000, 2001). Nukuoro clause structure shows that Case assignment need not co-occur with movement, and that clausal movement need not be associated with Case assignment. It also challenges notions of Activity (Chomsky 2000, 2001), showing that nominals that have received Case are not “inactive” for further movement.

Chapter 5 provided a structure for genitive relative clauses (GRCs) in Nukuoro, which analyzes genitive as a kind of exceptional case marking. I argued that subjects of GRCs occupy Spec,CP, the same position occupied by matrix subjects, which happens to be outside of the CP phase and thus is accessible to higher operations. A phase-based account allows us to understand why only pre-verbal subjects of relative clauses appear in genitive case in Nukuoro, while post-verbal subjects don't: post-verbal subjects remain in their base position in Spec,vP, and are contained within the CP phase. This kind of analysis, which relies on existing notions of phasehood (e.g., Chomsky 2000), allows us to explain why some languages employ genitive marking in clausal contexts but others don't. Languages that have a phase boundary between the genitive assigner and the subject will not allow genitive subjects; however, if subjects are unusually high, as in Nukuoro, or if the clause in question is structurally reduced and lacks a phase head (e.g., Hale 2002; Miyagawa 2008, 2011), the subject will be accessible for genitive assignment. This prediction connects the Nukuoro GRC construction with GRCs in other languages, such as Dagur and Japanese, which are argued to be maximally AspPs and TPs, respectively.

8.2.2 Syntactic ergativity

Chapter 6 showed that Nukuoro has a restriction on the \bar{A} -extraction of ergative arguments: relativization of transitive subjects requires additional voice morphology on the verb. Utilizing machinery developed to capture patterns of phi agreement and mixed A/ \bar{A} -movement (Coon & Bale 2014; Colley & Privoznov 2020), I develop a composite probe account of case discrimination, where a probe seeks an [\bar{A}] feature and an absolutive Case feature on the same goal. This analysis of ergative extraction thus captures the insights of earlier case discrimination accounts (Otsuka 2006, 2010a; Legate 2008a; Deal 2017b) using independently motivated mechanics.

As I present it here, the composite probe analysis characterizes the restriction as an *absolutive-only* restriction: only arguments which carry absolutive Case may undergo extraction, while other arguments, including ergatives as well as obliques, will fail to undergo extraction. Not all

syntactically ergative systems behave this way; for instance, some systems allow the extraction of (certain) obliques, despite banning the extraction of ergatives. As such, one way to extend the composite probe account would be to see how known parameterizations of probe structure or feature hierarchies could capture this variation. For instance, work by Deal (2015b, 2022, To appear) and Scott (2021) develops the idea that probes may utilize Boolean operators in their specifications, including intersection (i.e., conjunctive satisfaction) and union (i.e., disjunctive satisfaction)—one could imagine satisfaction conditions that include the negation operator, such as [SAT: \neg ERG], satisfied by any element which does not have the specified feature. Alternatively, one could explore the possibility that Case features have shared subcomponents, which allow certain Cases to be targeted to the exclusion of others (e.g., Caha 2009; Collins & Schuelke 2020), or that Case features should be organized into a feature geometry, as has been argued for phi-features (Harley & Ritter 2002) and \bar{A} -features (Aravind 2018). Tools like these may help us reframe and develop a theory of case accessibility hierarchies.

Nukuoro syntactic ergativity has several novel characteristics, which shed light on the ways that syntactically ergative systems should be analyzed cross-linguistically. First, the Nukuoro ergative extraction restriction appears in the absence of morphological case, which was previously thought to be unattested (Dixon 1994). However, such a system bears out the predictions of subsequent literature on the topic, because it follows from the combination of two standard assumptions: first, that abstract Case may exist without morphological realization (e.g., van der Wal 2015; Sheehan & van der Wal 2016) and second, that abstract Case is what underlies syntactic ergativity (e.g., Campana 1992; Bittner & Hale 1996a; Coon et al. 2014; Assmann et al. 2015; Deal 2017b). In this way, Nukuoro fills out the expected typology of syntactic ergativity and reaffirms the relationship between syntactic ergativity and abstract ergative Case assignment.

Nukuoro also provides a clear instance of syntactic ergativity in the absence of object inversion: subjects in Nukuoro are demonstrably higher than objects at all stages of the derivation. Object inversion is by far the standard analysis of ergative extraction restrictions (Campana 1992; Bittner & Hale 1996a; Aldridge 2004; Coon et al. 2014; Assmann et al. 2015; Coon et al. 2021; Clemens & Tollan 2021; Tollan & Clemens 2022), deriving a restriction on ergative \bar{A} -movement as a kind of intervention effect; some have gone so far as to say that object inversion is the defining characteristic of syntactic ergativity (Yuan & Ershova 2020). Nukuoro shows us that object inversion may be a frequent cause of syntactic ergativity, but it cannot be the only cause. I suggest that like ergativity itself, syntactic ergativity may be derived in multiple ways: as a result of inversion in some languages, as a result of case discrimination in others, and in other ways as well. These analyses have different hallmarks and different predictions, allowing them to capture a variety of patterns in testable ways.

8.2.3 Case assignment and representation

In Chapter 7, I explored ergative licensing phenomena in Nukuoro non-finite clauses, arguing that Nukuoro assigns abstract ergative Case in the absence of morphological case. The existence of abstract Case has been a subject of debate, with several proposals to eliminate abstract Case and the Case Filter from syntactic theory altogether (e.g., Marantz 1991; McFadden 2004; Landau

2006a; Bobaljik 2008; Levin 2015). However, Nukuoro provides evidence that Case is syntactically represented and required for nominal licensing (e.g., van der Wal 2015; van der Wal 2016; Halpert 2016), particularly given that the same morphological repair is used for syntactic ergativity contexts (which ostensibly involve Case; §8.2.2) and non-finite contexts, which lack a Case assigner. These facts also demonstrate the central role that non-finite clauses play in our understanding of abstract Case and ergativity.

The pattern of licensing in Nukuoro non-finite clauses supports the claim that ergative Case may be associated with T/Infl, which is found in theories of structural ergative Case (Levin & Massam 1985; Bobaljik 1993; Laka 1993; Otsuka 2000, 2006; Rezac et al. 2014) as well as models which characterize Case assignment as agreement with multiple functional heads (Deal 2010; Clem 2019). The Case assignment mechanism that I propose builds on both of these strands of literature by proposing that transitive subjects only agree with Infl, transitive objects only agree with *v*, but intransitive subjects enter into two Case dependencies with Infl and *v*. I further develop the view that Case representations are not featural primitives, but rather reflect the presence of a functional category feature on a nominal (Pesetsky & Torrego 2001; Deal 2010; Clem 2019). This representation of Case allows for a much more flexible understanding of how Case is assigned and referenced by other operations: for instance, I suggest that multiple category features on a nominal can be targeted by impoverishment rules (e.g., Halle & Marantz 1993; Bonet 1991; Noyer 1992), which alters the morphological expression of Case without changing any structural Case relationships.

The account that I propose for Nukuoro also reflects the core insight of dependent case theory (Marantz 1991; Baker 2015; Baker & Bobaljik 2017), which notes that accusative and ergative are assigned only when there are two arguments in the same Case assignment domain. While many have used this fact to develop configurational analyses of Case assignment (Baker 2015; Baker & Bobaljik 2017; Yuan 2022), the mechanism that I propose demonstrates that this dependence can also be captured on a more traditional view of structural Case assignment: ergative Case can be viewed as Agree with only Infl, which will only arise when *v* is able to Agree with another goal, namely the object. By attributing dependent Case to general intervention effects between probes and goals, we can reconcile configurational approaches with phenomena like nominal licensing, which link Case to particular functional structure.

Bibliography

- Abusch, Dorit. 1994. The scope of indefinites. *Natural Language Semantics* 2(2). 83–136.
- Akmajian, Adrian. 1975. More evidence for an NP cycle. *Linguistic Inquiry* 6(1). 115–130.
- Aldridge, Edith. 2002. Nominalization and wh-movement in Seediq and Tagalog. *Language and Linguistics* 3. 393–427.
- Aldridge, Edith. 2004. *Ergativity and word order in Austronesian languages*. Ithaca, NY: Cornell University dissertation.
- Aldridge, Edith. 2008. Generative approaches to ergativity. *Language and Linguistics Compass* 2(5). 966–995.
- Alexiadou, Artemis. 2001. *Functional structure in nominals: Nominalization and ergativity*. Amsterdam, Philadelphia: John Benjamins.
- Alexiadou, Artemis. 2017. Ergativity in nominalization. In Jessica Coon, Diane Massam & Lisa deMena Travis (eds.), *The Oxford Handbook of Ergativity*, 355–372. Oxford: Oxford University Press.
- Alexiadou, Artemis & Elena Anagnostopoulou. 1998. Parametrizing Agr: Word order, V-movement and EPP-checking. *Natural Language and Linguistic Theory* 16(3). 491–539.
- Anand, Pranav & Andrew Nevins. 2006. The locus of Ergative case assignment: Evidence from scope. In Alana Johns, Diane Massam & Juvénal Ndayiragije (eds.), *Ergativity: Emerging issues*, 3–25. Springer.
- Anderson, Stephen. 1976. On the notion of subject in ergative languages. In Charles N. Li (ed.), *Subject and topic*, 1–24. New York: Academic Press.
- Anderson, Stephen. 1977. On the mechanisms by which languages become ergative. In Charles Li (ed.), *Mechanisms of syntactic change*, Austin: University of Texas Press.
- Aravind, Athulya. 2018. Licencing long-distance wh-in-situ in malayalam. *Natural Language and Linguistic Theory* 36. 1–43.
- Assmann, Anke, Svetlana Edygarova, Doreen Georgi, Timo Klein & Philipp Weisser. 2014. Case stacking below the surface: On the possessor case alternation in Udmurt. *The Linguistic Review* 31(3-4). 447–485.
- Assmann, Anke, Doreen Georgi, Fabian Heck, Gereon Müller & Philipp Weisser. 2015. Ergatives move too early: On an instance of opacity in syntax. *Syntax* 18(4). 343–387.
- Aygen, Gülşat. 2007. Syntax and semantics of genitive subject case in Turkish. *California Linguistic Notes* XXXII, vol. 2. Spring.

- Baker, C. M. Kaliko. 2006. Hawaiian relative clause structure. In *Working Papers in Linguistics*, vol. 37, Honolulu: University of Hawai'i at Manoa.
- Baker, C. M. Kaliko. 2012. *A-class genitive subject effect: A pragmatic and discourse grammar approach to a- and o-class genitive subject selection in Hawaiian*: University of Hawai'i dissertation.
- Baker, Mark. 2008. *The syntax of agreement and concord*. Cambridge: Cambridge University Press.
- Baker, Mark. 2014. Pseudo-noun incorporation as covert noun incorporation: linearization and crosslinguistic variation. *Language and Linguistics* 15. 5–46.
- Baker, Mark. 2015. *Case: Its principles and its parameters*. Cambridge University Press.
- Baker, Mark & Jonathan David Bobaljik. 2017. On inherent and dependent theories of ergative case. In Jessica Coon, Diane Massam & Lisa deMena Travis (eds.), *The Oxford Handbook of Ergativity*, 111–134. Oxford: Oxford University Press.
- Baker, Mark & Nadya Vinokurova. 2010. Two modalities of Case assignment: case in Sakha. *Natural Language and Linguistic Theory* 28. 593–642.
- Baker, Mark C. 1988. *Incorporation: A theory of grammatical function changing*. Chicago: University of Chicago Press.
- Ball, Douglas. 2007. On ergativity and accusativity in Proto-Polynesian and Proto-Central Pacific. *Oceanic Linguistics* 46. 128–153.
- Baltin, Mark. 1978. *Toward a theory of movement rules*: Massachusetts Institute of Technology dissertation.
- Baltin, Mark. 1981. Strict bounding. In C. Lee Baker & John McCarthy (eds.), *The logical problem of language acquisition*, Cambridge, Massachusetts: MIT Press.
- Baltin, Mark. 2017. Extraposition. In Martin Everaert & Henk C. van Riemsdijk (eds.), *The Wiley Blackwell Companion to Syntax*, New York, NY: John Wiley & Sons, Inc.
- Bar-El, Leora, Peter Jacobs & Martina Wiltschko. 2001. A [+interpretable] number feature on verbs: Evidence from Squamish Salish. Paper presented at the West Coast Conference on Formal Linguistics 20, University of Southern California.
- Bauer, Winnifred. 1991. Maori *ko* again. *Te Reo* 34. 3–14.
- Bauer, Winnifred. 1993. *Maori Descriptive Grammar Series*. London: Routledge.
- Bauer, Winnifred. 1997. *The Reed Reference Grammar of Maori*. Auckland: Reed.
- Béjar, Susana. 2003. *Phi-syntax: A theory of agreement*. Toronto, Canada: University of Toronto dissertation.
- Bejar, Susana & Diane Massam. 1999. Multiple case checking. *Syntax* 2(2). 65–79.
- Béjar, Susana & Milan Rezac. 2003. Person licensing and the derivation of PCC effects. In Ana Teresa Perez-Leroux & Yves Roberge (eds.), *Romance linguistics: Theory and acquisition*, John Benjamins Publishing Company.
- Béjar, Susana & Milan Rezac. 2009. Cyclic agree. *Linguistic Inquiry* 40(1). 35–73.
- Besnier, Niko. 1986. Word order in Tuvaluan. In Paul Geraghty, Lois Carrington & S. A. Wurm (eds.), *FOCAL I: Papers from the Fourth International Conference on Austronesian Linguistics*, 245–268. Canberra: Pacific Linguistics.

- Besnier, Niko. 2000. *Tuvaluan: A Polynesian language of the Central Pacific*. London: Routledge.
- Bhatt, Rajesh. 2002. The raising analysis of relative clauses: evidence from adjectival modification. *Natural Language Semantics* 10(1). 43–90.
- Bhatt, Rajesh. 2005. Long distance agreement in Hindi-Urdu. *Natural Language and Linguistic Theory* 23(4). 757–807.
- Bianchi, Valentina. 1999. *Consequences of antisymmetry: headed relative clauses*. Berlin: Mouton de Gruyter.
- Bittner, Maria. 1994. Cross-linguistic semantics. *Linguistics and Philosophy* 17(1). 53–108.
- Bittner, Maria & Ken Hale. 1996a. Ergativity: Toward a theory of a heterogeneous class. *Linguistic Inquiry* 27(4). 531–604.
- Bittner, Maria & Ken Hale. 1996b. The structural determination of case and agreement. *Linguistic Inquiry* 27(1). 1–68.
- Bobaljik, Jonathan D. & Heidi Harley. 2017. Suppletion is local: Evidence from Hiaki. In Heather Newell, Maire Noonan, Glyne Piggott & Lisa deMena Travis (eds.), *The structure of words at the interfaces*, Oxford University Press.
- Bobaljik, Jonathan David. 1993. Ergativity and ergative unergatives. In Collin Phillips (ed.), *MIT Working Papers in Linguistics 19: Papers on case and agreement II*, 45–88. MITWPL.
- Bobaljik, Jonathan David. 2008. Where's Phi? Agreement as a postsyntactic operation. In Daniel Harbour, David Adger & Susana Béjar (eds.), *Phi theory*, 295–328. Oxford: Oxford University Press.
- Bobaljik, Jonathan David & Susi Wurmbrand. 2002. Notes on Itelmen agreement. *Linguistic Discovery* 1(1).
- Bochnak, Ryan. 2016. Past time reference in a language with optional tense. *Linguistics and Philosophy* 39. 247–294.
- Bochnak, Ryan & Lisa Matthewson. 2015. *Methodologies in semantic fieldwork*. Oxford, UK: Oxford University Press.
- Boeckx, Cedric & Norbert Hornstein. 2004. Movement under control. *Linguistic Inquiry* 35(3). 431–452.
- Bonet, Eulália. 1991. *Morphology after syntax: Pronominal clitics in Romance*. Cambridge, MA: Massachusetts Institute of Technology dissertation.
- Bossi, Madeline & Michael Diercks. 2019. V1 in Kipsigis: Head movement and discourse-driven scrambling. *Glossa: a journal of general linguistics* 4(1). 1–65.
- Bowern, Claire. 2008. *Linguistic fieldwork: A practical guide*. New York: Palgrave MacMillan.
- Branan, Kenyon & Michael Yoshitaka Erlewine. 2022. Ā-probing for the closest DP. *Linguistic Inquiry* 1–27.
- Broadwell, George Aaron. 1997. Binding theory and switch reference. In Hans Bennis, Pierre Pica & Johan Rooryck (eds.), *Atomism and binding*, 31–49. Dordrecht: Foris.
- Cable, Seth. 2010. *The grammar of Q: Q-particles, Wh-movement, and pied piping*. Oxford: Oxford University Press.
- Caha, Pavel. 2009. *The nanosyntax of Case*. Tromsø, Norway: The University of Tromsø disserta-

tion.

- Campana, Mark. 1992. *A movement theory of ergativity*: McGill University dissertation.
- Carnie, Andrew. 1995. *Head movement and non-verbal predication*: MIT dissertation.
- Carroll, Raymonde. 1980. *Nukuoro Stories*. Ann Arbor: University of Michigan Press.
- Carroll, Vern. 1964. *Place names on Nukuoro Atoll*, vol. 107 Atoll Research Bulletin. Washington, D.C.: The Pacific Science Board, National Academy of Sciences.
- Carroll, Vern. 1965a. An outline of the structure of the language of Nukuoro: Part I. *Journal of the Polynesian Society* 74(2). 192–226.
- Carroll, Vern. 1965b. An outline of the structure of the language of Nukuoro: Part II. *Journal of the Polynesian Society* 74(4). 451–472.
- Carroll, Vern. 1966. *Nukuoro kinship*: University of Chicago dissertation.
- Carroll, Vern. 1970. Adoption on Nukuoro. In Vern Carroll (ed.), *Adoption in Oceania*, 121–157. Honolulu: University of Hawai‘i Press.
- Carroll, Vern & Tobias Soulik. 1973. *Nukuoro lexicon*. Honolulu: University of Hawai‘i Press.
- Chomsky, Noam. 1965. *Aspects of the theory of syntax*. Cambridge, Massachusetts: M.I.T. Press.
- Chomsky, Noam. 1977a. Conditions on transformations. In *Essays on form and interpretation*, 81–162. New York, New York: Elsevier North-Holland, Inc.
- Chomsky, Noam. 1977b. On wh-movement. In P. Culicover, T. Wasow & A. Akmajian (eds.), *Formal syntax*, New York, New York: Academic Press.
- Chomsky, Noam. 1981. *Lectures on government and binding*. Dordrecht, The Netherlands: Foris Publications.
- Chomsky, Noam. 1982. *Some concepts and consequences of the theory of government and binding*. Cambridge, Massachusetts: MIT Press.
- Chomsky, Noam. 1993. A minimalist program for linguistic theory. In Ken Hale & Jay Keyser (eds.), *The view from Building 20*, 1–52. Cambridge, Massachusetts: MIT Press.
- Chomsky, Noam. 1995. *The Minimalist Program*. Cambridge, MA: MIT Press.
- Chomsky, Noam. 2000. Minimalist inquiries: The framework. In Roger Martin, David Michaels & Juan Uriagereka (eds.), *Step by step: Essays on minimalist syntax in honor of Howard Lasnik*, 89–156. MIT Press.
- Chomsky, Noam. 2001. Derivation by phase. In Michael Kenstowicz (ed.), *Ken Hale: A life in linguistics*, 1–52. Cambridge, MA: MIT Press.
- Christian, F. W. 1898. Nuku-oro vocabulary. *Journal of the Polynesian Society* 7(4). 224–232.
- Chung, Sandra. 1978. *Case Marking and Grammatical Relations in Polynesian*. Austin: University of Texas Press.
- Chung, Sandra. 2005. What fronts? On the VP-raising account of verb-initial word order. In Andrew Carnie, Heidi Harley & S.A. Dooley (eds.), *Verb first: On the syntax of verb initial languages*, 9–30. Amsterdam: John Benjamins.
- Chung, Sandra & William A. Ladusaw. 2004. *Restriction and saturation*. MIT Press.
- Cinque, Guglielmo. 1999. *Adverbs and functional heads: A cross-linguistic perspective*. New York, NY: Oxford University Press.

- Clark, Ross. 1973. Transitivity and case in Eastern Oceanic languages. *Oceanic Linguistics* 12. 559–605.
- Clark, Ross. 1976. *Aspects of Proto-Polynesian Syntax*. Auckland: Linguistic Society of New Zealand.
- Clem, Emily. 2019. *Agreement, case, and switch-reference in Amahuaca*: University of California, Berkeley dissertation.
- Clemens, Lauren. 2019. Prosodic noun incorporation: The relationship between prosody and argument structure in Niuean. *Syntax* 22(4). 337–377.
- Clemens, Lauren & Rebecca Tollan. 2021. Syntactic ergativity as absolutive movement in Tongic Polynesian. In Lauren Clemens & Diane Massam (eds.), *Polynesian Syntax and its Interfaces*, 89–112. Oxford: Oxford University Press.
- Clemens, Lauren Eby. 2014. *Prosodic noun incorporation and verb-initial syntax*. Cambridge, MA: Harvard University dissertation.
- Clemens, Lauren Eby & Jessica Coon. 2018. Deriving verb-initial word order in Mayan. *Language* 94(2). 237–280.
- Colley, Justin & Dmitry Privoznov. 2020. On the topic of subjects: Composite probes in Khanty. In Mariam Asatryan, Yixiao Song & Ayana Whitmal (eds.), *Proceedings of NELS 50*, 111–124. Amherst, MA: GLSA.
- Collins, James. 2013. The morphosyntax of ergativity in Samoan. Invited talk at *Syntax and Semantics Circle*. University of California, Berkeley.
- Collins, James. 2017. Samoan predicate initial word order and object positions. *Natural Language & Linguistic Theory* 35. 1–59.
- Collins, James. 2019. Definiteness determined by syntax: A case study in Tagalog. *Natural Language and Linguistic Theory* 37. 1367–1420.
- Collins, James & Peter Schuelke. 2020. Roviana fronting and the relationship between syntactic and morphological ergativity. In Ileana Paul (ed.), *Proceedings of AFLA 26*, University of Western Ontario.
- Cook, Kenneth W. 1996. The *Cia* suffix as a passive marker in Samoan. *Oceanic Linguistics* 35. 57–76.
- Coon, Jessica. 2010. VOS as predicate fronting in Chol. *Lingua* 120. 354–378.
- Coon, Jessica, Nico Baier & Theodore Levin. 2021. Mayan Agent Focus and the Ergative Extraction Constraint: Facts and fictions revisited. *Language* 97(2). 269–332.
- Coon, Jessica & Alan Bale. 2014. The interaction of person and number in Mi'gmaq. *Nordlyd* 40(1). 85–101.
- Coon, Jessica & Stefan Keine. 2021. Feature gluttony. *Linguistic Inquiry* 52(4). 655–710.
- Coon, Jessica, Diane Massam & Lisa deMena Travis. 2017. Introduction. In Jessica Coon, Diane Massam & Lisa deMena Travis (eds.), *The Oxford Handbook of Ergativity*, 1–18. Oxford University Press.
- Coon, Jessica, Petro Mateo Pedro & Omer Preminger. 2014. The role of case in A-bar extraction asymmetries: Evidence from Mayan. *Linguistic Variation* 14(2). 179–242.

- Coon, Jessica & Andrés Salanova. 2009. Nominalization and predicate-fronting: Two sources of ergativity. *Proceedings of the 32nd Annual Penn Linguistics Colloquium* 15(1). 45–54.
- Corbett, Greville G. 2000. *Number*. Cambridge University Press.
- Custis, T. 2004. *Word order variation in Tongan: a syntactic analysis*: University of Minnesota dissertation.
- Davidson, Janet. 1992. New evidence about the date of colonisation of Nukuoro Atoll, a Polynesian Outlier in the eastern Caroline Islands. *The Journal of the Polynesian Society* 101(3). 293–298.
- Dawson, Virginia. 2020. *Existential quantification in tiwa: Disjunction and indefinites*: University of California, Berkeley dissertation.
- Dayal, Veneeta. 2004. Number marking and (in)definiteness in kind terms. *Linguistics and Philosophy* 27(4). 393–450.
- Deal, Amy Rose. 2010. Ergative case and the transitive subject: a view from Nez Perce. *Natural Language and Linguistic Theory* 28. 73–120.
- Deal, Amy Rose. 2015a. Ergativity. In Artemis Alexiadou & Tibor Kiss (eds.), *Syntax - theory and analysis. An international handbook*, vol. 1 20, 654–708. Mouton de Gruyter.
- Deal, Amy Rose. 2015b. Interaction and satisfaction in ϕ -agreement. In T. Bui & D. Ozyildiz (eds.), *NELS* 45, 1–14.
- Deal, Amy Rose. 2016a. Plural exponence in the Nez Perce DP: a DM analysis. *Morphology* 26. 313–339.
- Deal, Amy Rose. 2016b. Syntactic ergativity: Analysis and identification. *Annual Review of Linguistics* 2. 165–185.
- Deal, Amy Rose. 2017a. Covert hyperraising to object. In Andrew Lamont & Katerina Tetzloff (eds.), *Proceedings of NELS* 47, 257–270. Amherst, MA: GLSA.
- Deal, Amy Rose. 2017b. Syntactic ergativity as case discrimination. In Aaron Kaplan et al. (ed.), *Proceedings of WCCFL* 34, 141–150. Somerville, MA: Cascadilla Proceedings Project.
- Deal, Amy Rose. 2022. Interaction, Satisfaction, and the PCC. *Linguistic Inquiry* 1–56.
- Deal, Amy Rose. To appear. Current models of Agree. In James Crippen, Rose-Marie Dechaine & Hermann Keupdjio (eds.), *Move and Agree: Towards a formal typology*, John Benjamins.
- Deal, Amy Rose & Julia Nee. 2018. Bare nouns, numbers, and definiteness in Teotitlán del Valle Zapotec. In Robert Truswell, Chris Cummins, Caroline Heycock, Brian Rabern & Hannah Rohde (eds.), *Proceedings of Sinn und Bedeutung* 21, 317–334. University of Edinburgh.
- Déchaine, Rose-Marie & Martina Wiltschko. 2002. Decomposing pronouns. *Linguistic Inquiry* 33(3). 409–442.
- Delsing, Lars-Olof. 1993. *The internal structure of Noun Phrases in the Scandinavian languages*: University of Lund dissertation.
- Diercks, Michael. 2012. Parameterizing case: Evidence from Bantu. *Syntax* 15(3).
- Diesing, Molly. 1990. Verb movement and the subject position in Yiddish. *Natural Language and Linguistic Theory* 8(1). 41–80.
- Dixon, R. M. W. 1972. *The Dyirbal language of North Queensland*. Cambridge University Press.
- Dixon, R. M. W. 1994. *Ergativity*. Cambridge University Press.

- Donner, William W. 2012. Sikaiana dictionary. Unpublished manuscript.
- Donohue, Mark & Lea Brown. 1999. Ergativity: Some additions from Indonesia. *Australian Journal of Linguistics* 19. 57–76.
- Douglas, Jamie. 2018. Māori subject extraction. *Glossa* 3. 1–34.
- Drummond, Emily. 2016. Possession and agentivity in Nukuoro. BA thesis, Bryn Mawr College.
- Drummond, Emily. 2020. A compositional semantic analysis of participant number. Poster presentation at the 92nd Annual Meeting of the LSA.
- Drummond, Emily. 2022a. Abstract ergative Case without morphological case. In Özge Bakay, Breanna Pratley, Eva Neu & Peyton Deal (eds.), *Proceedings of NELS 52*, 259–272. Amherst, MA: GLSA.
- Drummond, Emily. 2022b. The decline of ergativity in the Polynesian Outliers. Presentation at the Conference on Oceanic Linguistics 12, University of French Polynesia.
- Drummond, Emily. To appear. Maintaining syntactic identity under sluicing: Pseudoclefts and voice (mis)matches. In *Proceedings of WCCFL 39*, .
- Drummond, Emily & Johnny Rudolph. 2021. Nukuoro (Nukuoro Atoll, Pohnpei State, Federated States of Micronesia) - Language Snapshot. *Language Documentation & Description* 20. 145–153.
- Drummond, Emily & Johnny Rudolph (eds.). In prep. *Denga daalanga ma denga kai o nukuoro*. Manuscript, University of California, Berkeley.
- Drummond, Emily, Johnny Rudolph & K. David Harrison. 2019. A Nukuoro origin story. *Pacific Asia Inquiry* 10(1). 141–171.
- Durie, Mark. 1986. The grammaticalization of number as a verbal category. In Vassiliki Nikiforidou, Mary VanClay, Mary Niepokuj & Deborah Feder (eds.), *Proceedings of Berkeley Linguistics Society 12*, 355–370. Berkeley Linguistics Society Publications.
- Eilers, Anneliese. 1934. Islands around Ponape: Kapingamarangi, Nukuoro, Ngatik, Mokil, Pingelap. In Georg Thilenius (ed.), *Results of the South Sea expedition 1908–1910*, Hamburg: Friederichsen De Gruyter.
- Elbert, Samuel. 1946. Kapingamarangi and Nukuoro word list, with notes on linguistic position, pronunciation and grammar. Manuscript, United States Naval Military Government.
- Elbert, Samuel & Mary Kawena Pukui. 1979. *Hawaiian grammar*. Honolulu: University of Hawai‘i Press.
- Embick, David. 2010. *Localism versus globalism in morphology and phonology*. Cambridge, Massachusetts: MIT Press.
- Emonds, Joseph. 1972. Evidence that indirect object movement is a structure-preserving rule. *Foundations of Language* 8(4). 546–561.
- Erlewine, Michael Yoshitaka. 2016. Anti-locality and optimality in Kaqchikel Agent Focus. *Natural Language & Linguistic Theory* 34. 429–479.
- Erlewine, Michael Yoshitaka. 2018. Extraction and licensing in Toba Batak. *Language* 94(3). 662–697.
- Ershova, Ksenia. 2019. *Syntactic ergativity in West Circassian*: University of Chicago dissertation.
- Evans, Nicholas. 2008. Reciprocal constructions: Towards a structural typology. In Ekkehard

- König & Volker Gast (eds.), *Reciprocals and reflexives*, 33–104. Berlin: De Gruyter Mouton.
- Farkas, Donka. 1981. Quantifier scope and syntactic islands. In Randall Hendrick, Carrie Masek & Mary Frances Miller (eds.), *Papers from the 17th regional meeting of the Chicago Linguistic Society*, 59–66. University of Chicago: Chicago Linguistics Society.
- Feinberg, Richard & Richard Scaglione (eds.). 2012. *Polynesian Outliers: The state of the art* Ethnology Monographs 21. Pittsburgh, PA: University of Pittsburgh Press.
- Finer, Daniel. 1984. *The formal grammar of switch reference*: University of Massachusetts, Amherst dissertation.
- Finer, Daniel L. 1985. The syntax of switch-reference. *Linguistic Inquiry* 16(1). 35–55.
- Fodor, Janet Dean & Ivan Sag. 1982. Referential and quantificational indefinites. *Linguistics and Philosophy* 5. 355–398.
- Fong, Susanna. 2019. Proper movement through spec-cp: An argument from hyperraising in Mongolian. *Glossa* 4(1). 1–30.
- Fox, Danny. 1999. Reconstruction, binding theory, and the interpretation of chains. *Linguistic Inquiry* 30(2). 157–196.
- Fox, Danny & David Pesetsky. 2004. Cyclic linearization of syntactic structure. *Theoretical Linguistics* 31(1-2). 1–46.
- Freeze, Ray. 1992. Existentials and other locatives. *Language* 68(3). 553–595.
- Gagliardi, Annie, Michael Goncalves, Maria Polinsky & Nina Radkevich. 2014. The biabsolutive construction in Lak and Tsez. *Lingua* 150. 137–170.
- Georgi, Doreen. 2014. *Opaque Interactions of Merge and Agree: On the Nature and Order of Elementary Operations*: Universität Leipzig dissertation.
- Georgi, Doreen. 2017. Patterns of movement reflexes as the result of the order of Merge and Agree. *Linguistic Inquiry* 48(4). 585–626.
- Gong, Zhiyu Mia. 2022. A/Ā operations at the clausal periphery: Agree, movement, and the interpretation of chains. Manuscript, University of California, Santa Cruz.
- Grohmann, Kleanthes K. 2009. Exploring interfaces. In Kleanthes K. Grohmann (ed.), *Explorations of Phase Theory: Interpretation at the interfaces*, De Gruyter.
- Haji-Abdolhosseini, Mohammad, Diane Massam & Kenji Oda. 2002. Number and events: verbal reduplication in Niuean. *Oceanic Linguistics* 41(2). 475–492.
- Hale, Ken. 1983. Warlpiri and the grammar of non-configurational languages. *Natural Language and Linguistic Theory* 1(1). 5–48.
- Hale, Ken. 2002. On the Dagur object relative: Some comparative notes. *Journal of East Asian Linguistics* 11(2). 109–122.
- Halle, Morris & Alec Marantz. 1993. Distributed morphology and the pieces of inflection. In Kenneth Hale & Samuel Jay Keyser (eds.), *The view from building 20*, 111–176. Cambridge, Massachusetts: MIT Press.
- Halpert, Claire. 2016. *Argument licensing and agreement*. New York: Oxford University Press.
- Halpert, Claire. 2019. Raising, unphased. *Natural Language and Linguistic Theory* 37. 123–165.
- Hanink, Emily. 2021. DP structure and internally headed relatives in Washo. *Natural Language*

- and *Linguistic Theory* 39. 505–554.
- Harford Perez, Carolyn. 1985. *Aspects of complementation in three Bantu languages*. Madison, WI: University of Wisconsin-Madison dissertation.
- Harizanov, Boris & Vera Gribanova. 2018. Whither head movement? *Natural Language & Linguistic Theory* 1–62.
- Harley, Heidi & Rolf Noyer. 1998. Mixed nominalizations, short verb movement and object shift in English. In Pius N. Tamanji & Kiyomi Kusumoto (eds.), *Proceedings of the north east linguistic society*, 143–158. University of Toronto: Graduate Linguistic Student Association.
- Harley, Heidi & Elizabeth Ritter. 2002. Person and number in pronouns: A feature-geometric analysis. *Language* 78(3). 482–526.
- Harlow, Ray. 2007. *Maori: A linguistic introduction*. Cambridge: Cambridge University Press.
- Hawkins, Emily. 2000. Relative clauses in Hawaiian. In S. R. Fischer & W. B. Sperlich (eds.), *Leo pasifika: Proceedings of the fourth international conference on oceanic linguistics*, 127–141. Auckland: Institute of Polynesian Languages and Literatures.
- Herd, Jonathon, Catherine Macdonald & Diane Massam. 2011. Genitive subjects in relative constructions in Polynesian languages. *Lingua* 121. 1252–1264.
- Hohaus, Vera & Anna Howell. 2015. Alternative semantics for focus and questions: Evidence from Sāmoan. In *Proceedings of the meeting of the Austronesian Formal Linguistics Association (AFLA) 21*, 69–86.
- Holmberg, Anders. 1986. *Word order and syntactic features*: Stockholm dissertation.
- Homer, Vincent. 2009. Backward control in Samoan. In Sandra Chung, Daniel Finer, Ileana Paul & Eric Potsdam (eds.), *Proceedings of AFLA 16*, 45–59. University of California, Santa Cruz.
- Hooper, Robin. 1993. *Studies in Tokelauan syntax*: University of Auckland dissertation.
- Hopperditzel, Jens. 2020. *Resultatives: A view from Oceanic verb serialization*: Humboldt-University of Berlin dissertation.
- Hornstein, Norbert. 2000. Control in GB and minimalism. In Lisa L.-S. Cheng & Rint Sybesma (eds.), *The first glot international state-of-the-article book*, 27–45. New York: Mouton de Gruyter.
- Hulsey, Sarah & Uli Sauerland. 2006. Sorting out relative clauses. *Natural Language Semantics* 14(2). 111–137.
- Imanishi, Yusuke. 2014. *Default ergative*. Cambridge, MA: Massachusetts Institute of Technology dissertation.
- Jarvis, Rebecca. 2022. Raising and head-external relatives in Atchan. Manuscript, University of California, Berkeley.
- Jenks, Peter. 2023. Topic and focus in Tira. Presented at Syntax and Semantics Circle (SSCircle), UC Berkeley.
- Jenks, Peter & Rassidatou Konate. 2022. Indexed definiteness. *Glossa* 7. 1–44.
- Jeschke, Carl. 1913. Geschichte der Nukuoro Insulaner (Ost-Karolinen) aufgezeichnet in den Jahren 1910–13 während mehrmaligen Aufenthaltes dort [History of the Nukuoro Islanders (eastern Caroline Islands), recorded during several sojourns between 1910 and 1913]. Cologne: Rautenstrauch-Joest Museum – Kulturen der Welt, Archives.

- Johns, Alana. 1992. Deriving ergativity. *Linguistic Inquiry* 23. 57–88.
- Johns, Alana. 2000. Ergativity: a perspective on recent work. In Lisa L.-S. Cheng & Rint Sybesma (eds.), *The first glot international state-of-the-article book*, 47–73. New York: Mouton de Gruyter.
- Kalin, Laura. 2014. The syntax of OVS word order in Hixkaryana. *Natural Language and Linguistic Theory* 32. 1089–1104.
- Kaufmann, Christian & Oliver Wick (eds.). 2013. *Nukuoro: Sculptures from Micronesia*. Berlin: Hirmer.
- Kayne, Richard S. 1994. *The antisymmetry of syntax*. Cambridge, Massachusetts: MIT Press.
- Keenan, Edward L. & Bernard Comrie. 1977. Noun phrase accessibility and universal grammar. *Linguistic Inquiry* 8(1). 63–99.
- Kornfilt, Jaklin. 2008. Subject case and Agr in two types of Turkic RCs. In Boeckx, Cedric & Ulutaş, S. (eds.), *Proceedings of WAFL 4*, vol. 56 MITWPL, 145–168.
- Krause, Cornelia. 2001. *On reduced relatives with genitive subjects*. Cambridge, MA: Massachusetts Institute of Technology dissertation.
- Krupa, Viktor. 1994. Possession in Polynesian languages (cognitive basis of a linguistic category). *Asian and African Studies* 3(2). 176–182.
- Kubary, Johann Stanislaus. 1900. Beitrag zur Kenntnis der Nukuoro oder Monteverde Inseln [Contributions to the knowledge about the Nukuoro or Monteverde Islands]. In *Mitteilungen der Geographischen Gesellschaft in Hamburg*, vol. 16, 71–138. Hamburg: L. Frederischen & Co.
- Lahne, Antje. 2008. *Where There is Fire There is Smoke: Local Modelling of Successive-Cyclic Movement*: Leipzig University dissertation.
- Laka, Itziar. 1993. Unergatives that assign ergative, unaccusatives that assign accusative. In Jonathan David Bobaljik & Collin Phillips (eds.), *MIT Working Papers in Linguistics 18: Papers on case and agreement I*, 149–172. MITWPL.
- Laka, Itziar. 2006. Deriving split ergativity in the progressive: the case of Basque. In Alana Johns, Diane Massam & Juvenal Ndayiragije (eds.), *Ergativity: Emerging issues*, 173–196. Dordrecht: Springer.
- Landau, Idan. 2006a. Chain resolution in Hebrew V(P)-fronting. *Syntax* 9(1). 32–66.
- Landau, Idan. 2006b. Severing the distribution of PRO from case. *Syntax* 9(2). 153–170.
- Lasnik, Peter. 1995. *Plurality, conjunction and events*. Dordrecht, The Netherlands: Kluwer Academic Publishers.
- Lasnik, Howard. 1999. Chains of arguments. In Samuel Epstein & Norbert Hornstein (eds.), *Working minimalism*, 189–215. Cambridge, Massachusetts: MIT Press.
- Legate, Julie Anne. 2004. *Warlpiri: Theoretical implications*. Cambridge, MA: Massachusetts Institute of Technology dissertation.
- Legate, Julie Anne. 2008a. Dyirbal ergativity. Presented at the 82nd annual meeting of the Linguistic Society of America.
- Legate, Julie Anne. 2008b. Morphological and abstract case. *Linguistic Inquiry* 39(1). 55–101.
- Legate, Julie Anne. 2012. Types of ergativity. *Lingua* 112. 181–191.
- Legate, Julie Anne. 2014. Split ergativity based on nominal type. *Lingua* 148. 183–212.

- Levin, Juliette & Diane Massam. 1985. Surface ergativity: Case/theta relations explained. In *Proceedings of NELS 15*, Amherst, MA: GLSA.
- Levin, Theodore. 2015. *Licensing without Case*. Cambridge, MA: Massachusetts Institute of Technology dissertation.
- Lichtenberk, Frantisek. 2000. Inclusory pronominals. *Oceanic Linguistics* 39(1). 1–32.
- Little, Carol-Rose. 2020. *Mutual dependencies of nominal and clausal syntax in Ch'ol*. Ithaca, NY: Cornell University dissertation.
- Longenbaugh, Nicholas & Maria Polinsky. 2018. Equidistance returns. *The Linguistic Review* 35(3). 413–461.
- Lu, Jiayi. 2023. An adjunction analysis of clause chaining in Turkish. Presented at Syntax and Semantics Circle (SSCircle), University of California, Berkeley.
- Lynch, John. 1997. On the origin of the possessive markers in Polynesian languages. *Oceanic Linguistics* 36(2). 227–246.
- Mahajan, Anoop. 1997. Rightward scrambling. In Dorothee Beerman, David LeBlanc & Henk van Riemsdijk (eds.), *Rightward movement*, 185–213. Amsterdam: John Benjamins Publishing Company.
- Mahajan, Anoop. 2012. Ergatives, antipassives, and the overt light v in hindi. *Lingua* 122. 204–214.
- Mahajan, Anoop K. 1994. Against the relevance of subjacency at LF: the case of Hindi wh. *Linguistic Inquiry* 25(1). 171–179.
- Marantz, Alec. 1991. Case and licensing. In Germán Westphal, Benjamin Ao & Hee-Rahk Chae (eds.), *Eastern states conference on linguistics*, 234–253. Cornell University, Ithaca, NY: Cornell Linguistics Club.
- Marck, Jeffrey. 2000. *Topics in Polynesian language and culture history*. Canberra: Pacific Linguistics.
- Markman, Vita G. 2009. On the parametric variation of case and agreement. *Natural Language and Linguistic Theory* 27. 279–426.
- Massam, Diane. 2000. VSO and VOS: Aspects of Niuean word order. In Andrew Carnie & Eithne Guilfoyle (eds.), *The syntax of verb initial languages*, 97–116. Oxford University Press.
- Massam, Diane. 2001. Pseudo noun incorporation in Niuean. *Natural Language and Linguistic Theory* 19(1). 153–197.
- Massam, Diane. 2010. V1 or V2? On the left in Niuean. *Lingua* 120. 284–302.
- Massam, Diane, Josephine Lee & Nicholas Rolle. 2006. Still a preposition: The category of *ko*. *Te Reo* 49. 3–37.
- Massam, Diane & Carolyn Smallwood. 1997. Essential features of predication in English and Niuean. In Kiyomi Kusumoto (ed.), *Proceedings of north east linguistic society*, 263–272. McGill University: Graduate Linguistic Student Association.
- Matthewson, Lisa. 1999. On the interpretation of wide-scope indefinites. *Natural Language Semantics* 7(1). 79–134.
- Matthewson, Lisa. 2004. On the methodology of semantic fieldwork. *International Journal of American Linguistics* 70(4).

- Matushansky, Ora. 2006. Head movement in linguistic theory. *Linguistic Inquiry* 37(1). 69–109.
- Matushansky, Ora. 2008. On the linguistic complexity of proper names. *Linguistics and Philosophy* 31. 573–627.
- McCreight, Katherine. 1988. *Multiple case assignments*. Cambridge, MA: Massachusetts Institute of Technology dissertation.
- McFadden, Thomas. 2004. *The position of morphological case in the derivation: A study on the syntax-morphology interface*. Philadelphia, PA: University of Pennsylvania dissertation.
- Medeiros, D. 2013. Hawaiian VP-remnant movement: A cyclic linearization approach. *Lingua* .
- Merchant, Jason. 2006. Polyvalent case, geometric hierarchies, and split ergativity. *Chicago Linguistics Society (CLS)* 42. 47–67.
- Middleton, John. 2021. Revisiting the clause periphery in Polynesian languages. *Glossa: a journal of general linguistics* 6(1). 1–87.
- Mikkelsen, Line. 2005. *Copular clauses: Specification, predication and equation*. Amsterdam and Philadelphia: John Benjamins.
- Mithun, Marianne. 1984. The evolution of noun incorporation. *Language* 60. 847–894.
- Mithun, Marianne. 1988. Lexical categories and the evolution of number marking. In Michael Hammond & Michael Noonan (eds.), *Theoretical morphology*, 211–234. San Diego, California: Academic Press, Inc.
- Miyagawa, Shigeru. 2008. Genitive subjects in altaic. In Ulutaş, S. & Boeckx, Cedric (eds.), *Proceedings of the workshop on altaic formal linguistics (WAFL4)*, Cambridge, MA: MIT Working Papers in Linguistics 56.
- Miyagawa, Shigeru. 2011. Genitive subjects in Altaic and specification of phase. *Lingua* 121. 1265–1282.
- Moravcsik, Edith A. 1978. On the distribution of ergative and accusative patterns. *Lingua* 45. 233–279.
- Moroney, Mary. 2021. Updating the typology of definiteness: Evidence from bare nouns in Shan. *Glossa* 6. 1–56.
- Mosel, Ulrike & Even Hovdhaugen. 1992. *Samoan reference grammar*. Oslo: Scandinavian Press.
- Moyse-Faurie, Claire. 2010. (dé)Grammaticalisation d'expressions spatiales dans les langues océaniques. In Injoo Choi-Jonin, Marc Duval & Olivier Soutet (eds.), *Typologie et comparatisme: Hommages offerts à Alain Lemaréchal*, 295–314. Leuven: Peeters.
- Moyse-Faurie, Claire. 2019. Existential and locative predication in some eastern Oceanic languages. *Te Reo* 62(1). 49–74.
- Muāgututi'a, Grant. 2018. *Recovering ergativity in heritage Samoan*: University of Hawai'i at Mānoa dissertation.
- Murasugi, Kumiko. 1992. *Crossing and nested paths: NP movement in accusative and ergative languages*: Massachusetts Institute of Technology dissertation.
- Neeleman, Ad & Fred Weerman. 1993. The balance between syntax and morphology: Dutch particles and resultatives. *Natural Language and Linguistic Theory* 11(3). 433–476.
- Nordlinger, Rachel. 1998. *Constructive case: Evidence from Australian languages*. Stanford: CSLI.

- Nordlinger, Rachel. 2023. The typology of reciprocal constructions. *Annual Review of Linguistics* 9. 71–91.
- Noyer, Rolf. 1992. *Features, positions, and affixes in autonomous morphological structure*. Cambridge, MA: Massachusetts Institute of Technology dissertation.
- Nunes, Jairo. 2004. *Linearization of chains and sideward movement* Linguistic Inquiry Monographs. Cambridge, Massachusetts: MIT Press.
- Ordóñez, Francisco. 1995. The antipassive in Jacaltec: a last resort strategy. *CatWPL* 4(2). 329–343.
- Ortiz de Urbina, Jon. 1989. *Parameters in the grammar of Basque*. Dordrecht: Foris.
- Ota, Katsuhiko. 2000. *Aspects of case-marking and transitivity in Polynesia*: University of Hawai'i dissertation.
- Otsuka, Yuko. 2000. *Ergativity in Tongan*. Oxford: Oxford University dissertation.
- Otsuka, Yuko. 2002. Split ergativity and the nature of pronouns in Tongan. *Proceedings of AFLA 8, MIT Working Papers in Linguistics* 44. 197–210.
- Otsuka, Yuko. 2005. Two derivations of VSO: a comparative study of Niuean and Tongan. In Andrew Carnie, Heidi Harley & Sheila Ann Dooley (eds.), *Verb first: On the syntax of verb-initial languages*, 65–90. Amsterdam/Philadelphia: John Benjamins.
- Otsuka, Yuko. 2006. Syntactic ergativity in Tongan: Resumptive pronouns revisited. In Alana Johns, Diane Massam & Juvenal Ndayiragije (eds.), *Ergativity*, 79–107. Springer.
- Otsuka, Yuko. 2010a. DP ellipsis in Tongan: Is syntactic ergativity real? *Natural Language & Linguistic Theory* 28(2). 315–342.
- Otsuka, Yuko. 2010b. Genitive relative constructions and agent incorporation in tongan. In Raphael Mercado, Eric Potsdam & Lisa deMena Travis (eds.), *Austronesian and theoretical linguistics*, 117–140. John Benjamins.
- Oxford, Will. 2017. The Activity Condition as a microparameter. *Linguistic Inquiry* 48(4). 711–722.
- Oyharçabal, Beñat. 1992. Structural Case and inherent case marking: ergaccusativity in Basque. In Joseba A. Lakarra & Jon Ortiz de Urbina (eds.), *Syntactic theory and Basque syntax*, 309–342. Donostia: Gipuzkoako Diputazioa.
- Partee, Barbara Hall. 1975. Montague grammar and transformational grammar. *Linguistic Inquiry* 6(2). 203–300.
- Patel, Pritty. 2007. *Split ergativity and the nature of agreement*: University College London MA thesis.
- Pawley, Andrew. 2001. Proto Polynesian *-CIA. In Joel Bradshaw & Kenneth L. Rehg (eds.), *Issues in Austronesian morphology: a focusshrift for Byron W. Bender*, 193–216. Pacific Linguistics, The Australian National University.
- Payne, Doris & Immanuel Barshi (eds.). 1999. *External possession*. Amsterdam: John Benjamins.
- Payne, Thomas E. 1997. *Describing morphosyntax: A guide for field linguists*. Cambridge: Cambridge University Press.
- Pearce, Elizabeth. 1999. Topic and focus in a head-initial language: Maori. In Carolyn Smallwood & Catherine Kitto (eds.), *Proceedings of AFLA VI: The sixth meeting of the Austronesian Formal Linguistics Association*, 249–263. Toronto: University of Toronto.

- Pearson, Matthew. 2001. *The clause structure of Malagasy: A Minimalist approach*. Los Angeles, CA: University of California, Los Angeles dissertation.
- Pesetsky, David. 2014. *Russian case morphology and the syntactic categories* Linguistic Inquiry Monograph. Cambridge, MA: MIT Press.
- Pesetsky, David & Esther Torrego. 2001. T-to-C movement: Causes and consequences. In Michael Kenstowicz (ed.), *Ken Hale: A life in language*, 355–426. MIT Press.
- Platzack, Christer & Inger Rosengren. 1997. On the subject of imperatives: A minimalist account of the imperative pronoun and negated imperative. *Journal of Comparative Germanic Linguistics* 1. 177–224.
- Pohnpei State Department of Education. 2022. *Pohnpei studies reader: Nukuoro history*. Pohnpei, Federated States of Micronesia.
- Polinsky, Maria. 2016. *Deconstructing ergativity: Two types of ergative languages and their features*. Oxford: Oxford University Press.
- Polinsky, Maria. 2017a. Antipassive. In Jessica Coon, Diane Massam & Lisa deMena Travis (eds.), *The Oxford Handbook of Ergativity*, 308–331. Oxford University Press.
- Polinsky, Maria. 2017b. Syntactic ergativity. In Martin Everaert & Henk C. van Riemsdijk (eds.), *The Wiley Blackwell Companion to Syntax*, John Wiley & Sons, Inc.
- Polinsky, Maria & Eric Potsdam. 2002. Backward control. *Linguistic Inquiry* 33(2). 245–282.
- Pollock, Jean-Yves. 1989. Verb movement, UG and the structure of IP. *Linguistic Inquiry* 20. 365–424.
- Postal, Paul. 1974. *On raising*. Cambridge, Massachusetts: MIT Press.
- Potsdam, Eric & Maria Polinsky. 2011. Questions and word order in Polynesian. In Claire Moyse-Faurie & Joachim Sabel (eds.), *Topics in Oceanic Morphosyntax*, 121–153. Berlin: Mouton de Gruyter.
- Preminger, Omer. 2014. *Agreement and its failures* (Linguistic Inquiry Monograph 68). Cambridge, MA: MIT Press.
- Rackowski, Andrea & Lisa Travis. 2000. V-initial languages: X or XP movement and adverbial placement. In Andrew Carnie & Eithne Guilfoyle (eds.), *The syntax of verb initial languages*, 117–142. Oxford: Oxford University Press.
- Ramchand, Gillian & Peter Svenonius. 2002. The lexical syntax and lexical semantics of the verb-particle construction. In Line Mikkelsen & Christopher Potts (eds.), *Proceedings of WCCFL 21*, 387–400. Somerville, MA: Cascadilla Press.
- Ramchand, Gillian & Peter Svenonius. 2014. Deriving the functional hierarchy. *Language Sciences* 46. 152–174.
- Reinhart, Tanya. 1981. Pragmatics and linguistics: An analysis of sentence topics. *Philosophica* 1. 53–94.
- Reinhart, Tanya. 1997. Quantifier scope: How labor is divided between QR and choice functions. *Linguistics and Philosophy* 20(4). 335–397.
- Rezac, Milan. 2003. The fine structure of Cyclic Agree. *Syntax* 6. 156–182.
- Rezac, Milan. 2004. *Elements of cyclic syntax: Agree and Merge*. Toronto, Canada: University of

- Toronto dissertation.
- Rezac, Milan. 2011. *Phi-features and the modular architecture of language*. Dordrecht: Springer.
- Rezac, Milan, Pablo Albizu & Ricardo Extepare. 2014. The structural ergative of Basque and the theory of Case. *Natural Language & Linguistic Theory* 32. 1273–1330.
- Richards, Norvin. 2001. *Movement in language: interactions and architectures*. Oxford: Oxford University Press.
- Richards, Norvin. 2013. Lardil “case stacking” and the timing of case assignment. *Syntax* 16(1). 42–76.
- Rizzi, Luigi. 1990. *Relativized minimality*. Cambridge, Massachusetts: MIT Press.
- Rizzi, Luigi. 1997. The fine structure of the left periphery. In Liliane Haegeman (ed.), *Elements of grammar*, 281–337. Dordrecht: Kluwer Academic Publishers.
- Rosen, Sara. 1989. Two types of noun incorporation: A lexical analysis. *Language* 65(2). 294–317.
- Rosenbaum, Peter S. 1967. *The grammar of English predicate complement constructions*. Cambridge, MA: MIT Press.
- Ross, John. 1967. *Constraints on variables in syntax*: Massachusetts Institute of Technology dissertation.
- Royer, Justin. 2022. *Elements of (in)definiteness and binding: A Mayan perspective*. Montreal: McGill University dissertation.
- Sadock, Jerrold. 1980. Noun incorporation in Greenlandic: A case of syntactic word formation. *Language* 56. 300–319.
- Safir, Ken. 2019. The A/Ā distinction as an epiphenomenon. *Linguistic Inquiry* 50(2). 285–336.
- Salanova, Andrés. 2007. *Nominalizations and aspect*. Cambridge, MA: Massachusetts Institute of Technology dissertation.
- Salmond, Anne. 1974. *A generative syntax of Luangiua*. Berlin: De Gruyter Mouton.
- Salzmann, Martin. 2017a. Prolepsis. In Martin Everaert & Henk van Riemsdijk (eds.), *The Wiley-Blackwell Companion to Syntax*, vol. 5, 3203–3245. Wiley-Blackwell.
- Salzmann, Martin. 2017b. *Reconstruction and resumption in indirect A'-dependencies: On the syntax of prolepsis and relativization in (Swiss) German and beyond*. Berlin: De Gruyter Mouton.
- Sauerland, Uli. 1998. *The meaning of chains*. Cambridge, Massachusetts: Massachusetts Institute of Technology dissertation.
- Sauerland, Uli. 2000. The content of pronouns: Evidence from focus. In Brendan Jackson & Tanya Matthews (eds.), *Proceedings of SALT X*, 167–184. Cornell University, Ithaca, NY: CLC Publications.
- Sauerland, Uli. 2003. Unpronounced heads in relative clauses. In Kerstin Schwabe & Susanne Winkler (eds.), *The interfaces: Deriving and interpreting omitted structures*, 205–226. Amsterdam: John Benjamins.
- Schmerling, Susan. 1975. Imperative subject deletion and some related matters. *Linguistic Inquiry* 6. 501–511.
- Schneider-Zioga, Patricia. 2007. Anti-agreement, anti-locality and minimality. *Natural Language and Linguistic Theory* 25(2). 403–446.

- Scott, Tessa. 2021. Formalizing two types of mixed A/Ā movement. Manuscript, University of California, Berkeley.
- Scott, Tessa. 2023. *Pronouns and agreement in san juan atitán mam*: University of California, Berkeley dissertation.
- Seiter, William J. 1980. *Studies in Niuean Syntax*. New York: Garland Publishing Company.
- Sheehan, Michelle & Jenneke van der Wal. 2018. Evidence for nominal licensing in caseless languages. *Journal of Linguistics* 54. 527–589.
- Sheehan, Michelle & Jenneke van der Wal. 2016. Do we need abstract Case? In Kyeong min Kim et. al (ed.), *Proceedings of WCCFL 33*, Somerville, MA: Cascadilla Proceedings Project.
- Stone, Benjamin. 1966. Some vernacular names of plants from Kapingamarangi and Nukuoro Atolls, Caroline Islands. *Micronesia* 2. 131–132.
- Taboroši, Danko, Betty Amon, Emily Drummond, Benjamin Ludwig & Johnny Rudolph. In prep. *Muna Nuguolo: A Nukuoro phrasebook*. Pohnpei, Federated States of Micronesia: Island Research and Education Initiative (iREi).
- Takahashi, Shoichi. 2010. Traces or copies, or both: Part I: Characterizing movement properties. *Language and Linguistics Compass* 4. 1091–1103.
- Theode-Arora, Hilke. 2013. German sources on Nukuoro and the ancestor statues: Kubary, Jeschke, and the Hamburg South Seas Expedition. In Christian Kaufmann & Oliver Wick (eds.), *Nukuoro: Sculptures from micronesia*, 44–59. Berlin: Hirmer.
- Thornton, Abigail. 2020. *Morphophonological and morphosyntactic domains*. Storrs, CT: University of Connecticut dissertation.
- Tollan, Rebecca. 2018. Unergatives are different: Two types of transitivity in Samoan. *Glossa* 3(1). 1–41.
- Tollan, Rebecca & Lauren Clemens. 2022. Syntactic ergativity as a constraint on crossing dependencies: The perspective from Mayan. *Linguistic Inquiry* 53(3). 459–499.
- Toosarvandani, Maziar. 2016. Vocabulary insertion and locality: Verb suppletion in Northern Paiute. In *Proceedings of NELS 46*, .
- Ura, Hiroyuki. 1994. *Varieties of raising and the feature-based bare phrase structure theory*: MIT dissertation.
- Ura, Hiroyuki. 2001. Case. In Mark Baltin & Chris Collins (eds.), *The Handbook of Contemporary Syntactic Theory*, 334–373. Blackwell Publishers.
- van Urk, Coppe. 2015. *A uniform syntax for phrasal movement: A case study of Dinka Bor*. Cambridge, MA: Massachusetts Institute of Technology dissertation.
- van Urk, Coppe. 2022. Constraining predicate fronting. *Linguistic Inquiry* 1–68.
- van der Wal, Jenneke. 2015. Evidence for abstract Case in Bantu. *Lingua* 165. 109–132.
- Vassilieva, Masha & Richard K. Larson. 2005. The semantics of the plural pronoun construction. *Natural Language Semantics* 13(2). 101–124.
- Veselinova, Ljuba. 2006. *Suppletion in verb paradigms: Bits and pieces of the puzzle*. Amsterdam: John Benjamins.
- van der Wal, Jenneke. 2016. Diagnosing focus. *Studies in Language* 40(2). 259–301.

- Walworth, Mary & Albert Davletshin. 2019. New perspectives on Eastern Polynesian subgrouping. Paper presented at the 11th Conference on Oceanic Linguistics (COOL11), University of New Caledonia, Noumea, New Caledonia.
- Walworth, Mary, Simon Greenhill, Aymeric Hermann & Russell Gray. in prep. Polynesian language phylogenies reveal multiple migrations to the Outlier islands.
- Wilson, William H. 1976a. *The o and a possessive markers in Hawaiian*. Honolulu: University of Hawai'i at Mānoa dissertation.
- Wilson, William H. 1976b. The o/a distinction in Hawaiian possessives. *Oceanic Linguistics* 15(1). 39–50.
- Wilson, William H. 2012. Whence the East Polynesians? Further evidence for a Northern Outlier source. *Oceanic Linguistics* 51(2). 289–359.
- Wilson, William H. 2014. Pukapukan and the NO-EPn Hypothesis: Extensive late borrowing by Pukapukan. *Oceanic Linguistics* 53(2). 392–442.
- Wilson, William H. 2018. The Northern Outliers-East Polynesian Hypothesis expanded. *Journal of the Polynesian Society* 127(4). 389–423.
- Wilson, William H. 2021. East Polynesian subgrouping and homeland implications within the Northern Outlier-East Polynesian Hypothesis. *Oceanic Linguistics* 60(1). 36–71.
- Wiltschko, Martina. 2014. *The universal structure of categories: Towards a formal typology*. Cambridge University Press.
- Woolford, Ellen. 1997. Four-way case systems: Ergative, nominative, objective and accusative. *Natural Language and Linguistic Theory* 15(1). 181–227.
- Woolford, Ellen. 2006. Lexical case, inherent case, and argument structure. *Linguistic Inquiry* 37(1). 111–130.
- Wurmbrand, Susi. 2001. *Infinitives: Restructuring and clause structure*. Mouton de Gruyter.
- Yip, Moira, Joan Maling & Ray Jackendoff. 1987. Case in tiers. *Language* 63. 217–250.
- Yu, Kristine. 2021. Tonal marking of absolutive case in Samoan. *Natural Language & Linguistic Theory* 39. 291–365.
- Yuan, Michelle. 2022. Ergativity and object movement across Inuit. *Language* 98(3). 510–551.
- Yuan, Michelle & Ksenia Ershova. 2020. Dependent case in syntactically ergative languages: Evidence from Inuit and West Circassian. Paper presented at the 94th annual meeting of the LSA.
- Zanda, Cor. 2023. Morphosyntactic changes in the Polynesian thematic suffixes. BA thesis, University of California, Berkeley.
- Zanuttini, Raffaella. 2008. Encoding the addressee in the syntax: Evidence from English imperative subjects. *Natural Language and Linguistic Theory* 26. 185–218.
- Zhang, Niina Ning. 2010. *Coordination in syntax*. Cambridge University Press.
- Zyman, Erik. 2017. P'urhepecha hyperraising to object: An argument for purely altruistic movement. In Patrick Farrell (ed.), *Proceedings of the Linguistic Society of America*, vol. 2, Washington, D.C.: Linguistic Society of America.
- Zyman, Erik. 2018. *On the driving force for syntactic movement*: University of California, Santa

Cruz dissertation.

Appendix A

Glossed texts

A.1 Introduction

This appendix contains 11 glossed and translated narratives told by Nukuoro speakers on Nukuoro Atoll in the spring of 1966. These texts were recorded and transcribed by anthropologist Raymonde Carroll, with the assistance of speaker Tobias Soulik, and subsequently published as a monolingual book of Nukuoro stories (Carroll 1980). The publication indicates that there are corresponding reel-to-reel tapes, but so far it is not clear where these tapes are located.

Johnny Rudolph and I glossed and translated these texts between June 2022 and June 2023. We made minor changes to spelling and word boundaries to reflect modern orthographic conventions where possible, and lightly edited the stories to omit repetitions and false starts. Line breaks are preserved from the original publication.

Here, I provide a brief summary and metadata for each text, including the name of the speaker and the unique two-numeral story code assigned to the text in Carroll (1980). The first number indicates the reel on which the story was recorded; the second is the sequence of the story on that reel. While the reels have not been located, the story code provides a way to disambiguate narratives told by the same speaker on different days.

A.2 Taalanga o Vave (10-1) – Gininga

Speaker: Gininga

Date recorded: Spring 1966

Location: Nukuoro Atoll, Pohnpei State, Federated States of Micronesia

Recording information: Reel 10, story 1

Gininga tells the story of Vave, the son of the king of Samoa who is the first settler of Nukuoro Atoll. Gininga describes the discovery of Nukuoro by Gaeuli, Vave's son-in-law, the fate of a woman named Inahia on Samoa, the death of Vave's son Iaidemalo, and Vave's quest to avenge his son's death, resulting in Vave sacrificing himself and becoming a deity named Ssamoulidaane.

- (1) Ga noho laa huu a Gaeuli. Ia se balia.
 PRSP live DIST when PN Gaeuli 3SG COP.SG navigator
 ‘There lived a man named Gaeuli. He was a navigator.’
- (2) Dahi laangi huu gai ia ga maanadu age i Saamoā bolo ia ga humai e
 one day when then 3SG PRSP think up PREP Samoa COMP 3SG PRSP come IPFV
 sala henua.
 search island
 ‘One day, he decided in Samoa that he would go and look for islands.’
- (3) Ia e hai bodu ange gi luu damaa hine a Vave.
 3SG IPFV make spouse DIR.DIST to DET.DU child woman GEN.A Vave
 ‘He was married to the two daughters of Vave.’
- (4) Ingoō luu damaa hine a Vave go Gauna ma Hagalolo.
 name DET.DU child woman GEN.A Vave COP.FOC Gauna and Hagalolo
 ‘The names of Vave’s two daughters were Gauna and Hagalolo.’
- (5) Gai ia ga basa ange gi lu-oono bodu
 then 3SG PRSP talk DIR.DIST to DET.DU-3SG.GEN.O spouse
 ‘So he talked to his two wives’
- (6) gai ia ga humai ai loo.
 then 3SG PRSP come.SG OBL EMPH
 ‘and he came here (to Nukuoro).’
- (7) Gai ia ga humai ga hagadaahao mai i de moana ga humai ai
 then 3SG PRSP come.SG PRSP play DIR.PROX PREP DET ocean PRSP come.SG OBL
 ‘So he came and was sightseeing on the open sea and he came’
- (8) ga humai humai humai humai huu ia gi ono henua ne dau ai laa
 PRSP come.SG come.SG come.SG come.SG when 3SG to 3SG.GEN.O island PFV reach OBL DIST
 ga humai gu dae mai gi de henua nei.
 PRSP come.SG INC arrive DIR.PROX to DET island PROX
 ‘and he sailed and sailed and sailed to the island that he reached, he came and arrived at
 this island.’

- (9) Ga dae mai huu ia gi de henua nei e deai donu dangada aana
 PRSP arrive DIR.PROX when 3SG to DET island PROX IPFV no EMPH person 3SG.GEN.A
 e gide ai.
 IPFV see OBL
 'When he arrived on this island, he found no people there.'
- (10) Ia ne dau i de henua nei se boo.
 3SG PFV reach PREP DET island PROX COP.SG night
 'He reached this island at night.'
- (11) Gai ia ga sele d-ana libo i dua ssugi i ngaage
 then 3SG PRSP cut DET-3SG.GEN.A jack PREP back DET.tail PREP south
 'So he cut his jack on the left side of the channel where the waves break,'
- (12) ga gaa-mai ga hhao gi lot-ono moni ga hano iho ai gi
 PRSP bring-DIR.PROX PRSP put.into to inside.DET-3SG.GEN.O canoe PRSP go.SG down OBL to
 dai i de ava
 lagoon PREP DET channel
 'he put the fish back into the canoe and sailed into the lagoon through the channel'
- (13) ga humai ga han-age gi uda i dai de Laovage
 PRSP come.SG PRSP go.SG-up to inland PREP lagoon DET Laovage
 'and came and went ashore on the lagoon-side of Laovage'
- (14) ga daula ai d-ono moni gai ia ga doo ga han-age gi uda
 PRSP anchor OBL DET-3SG.GEN.O canoe so 3SG PRSP fall PRSP go.SG-up to inland
 'and he anchored his canoe there and he got off and went inland'
- (15) ga siga d-ana ahi ga hakaa ai d-ana ahi ga dunu ai
 PRSP start.fire DET-3SG.GEN.A fire PRSP build.fire OBL DET-3SG.GEN.A fire PRSP cook OBL
 d-ana libo
 DET-3SG.GEN.A jack
 'and started his fire and built his fire and cooked his jack'
- (16) ga gai gu odi gai ia ga humai e dagodo iho e seni.
 PRSP eat INC finish so 3SG PRSP come.SG IPFV lay down IPFV sleep
 'and ate it and then he went and laid down to sleep.'

- (17) Gai a Sogo ga haga-ago ono eidu go denga gai-bea
 then PN Sogo PRSP CAUS-teach 3SG.GEN.O ghost COP.FOC DET.PL crab
 ‘Then Sogo commanded his ghosts, the crabs’
- (18) gilaadeu gi loomai gi daalaa de moni o Gaeuli gi dahea gi hano
 3PL SBJV come.PL SBJV untie.CIA DET canoe GEN.O Gaeuli SBJV drift SBJV go.SG
 ‘to come and untie Gaeuli’s canoe so that it would drift away’
- (19) gi dee iloo ai e Gaeuli de noho i de henua nei.
 SBJV NEG know OBL ERG Gaeuli DET live PREP DET island PROX
 ‘so that Gaeuli could not stay on this island.’
- (20) Gai Gaeuli ga dolu huu be haa hanonga aana ne gide ai de dahea
 then Gaeuli PRSP three when or four times 3SG.GEN.A PFV see OBL DET drift
 d-ono moni gai ia gu dee lodo e noho i de henua nei.
 DET-3SG.GEN.O canoe then 3SG INC NEG want IPFV live PREP DET island PROX
 ‘And Gaeuli, after three or four times that he saw his canoe drift away, he no longer
 wanted to stay on this island.’
- (21) Ia gu goso ma de dalea gai ia ga ahe
 3SG INC bothered and DET tired then 3SG PRSP return
 ‘He was bothered and tired so he went back’
- (22) ga gage ange gi hongaa d-ono moni ga ahe ai ga hano.
 PRSP climb DIST.DIR to top DET-3SG.GEN.O canoe PRSP return OBL PRSP go.SG
 ‘and climbed back on his canoe and left.’
- (23) Gai ia ga hano hano huu gu dae gi Saamoa
 then 3SG PRSP go.SG go.SG when INC reach to Samoa
 ‘So he went and went until he reached Samoa’
- (24) gai ia ga tala ange gi lu-oono bodu
 so 3SG PRSP tell DIST.DIR to DET.DU-3SG.GEN.O spouse
 ‘and he told his two wives’
- (25) go luu damaa hine a Vave
 COP.FOC DET.DU child woman GEN.A Vave
 ‘Vave’s two daughters’

- (26) bolo ia gu gidee dahi henua hoou deai donu dangada e nnoho ai.
 COMP 3SG INC see one island new no EMPH person IPFV live.PL OBL
 ‘that he found a new island that nobody lived on.’
- (27) Go Sogo donu huu sogosogo e noho ai ma ono eidu.
 COP.FOC Sogo only alone IPFV live OBL with 3SG.GEN.O ghost
 ‘Only Sogo lived there with his ghosts.’
- (28) Gai a Vave ga maanadu age bolo gilaadeu ga loomai loo ma d-ono
 then PN Vave PRSP think up COMP 3PL PRSP come.PL EMPH and DET-3SG.GEN.O
 huaa bodu gi de henua gide hoou a d-ono saulaba go Gaeuli.
 family to DET island see new GEN.A DET-3SG.GEN.O in.law COP.FOC Gaeuli
 ‘And Vave decided that he would go with his family to this new island that his son-in-law
 Gaeuli found.’
- (29) Gilaadeu ga haga-baba olaadeu mee ga do-ange bolo gilaadeu ga loomai
 3PL PRSP CAUS-ready 3PL.GEN.O thing PRSP drop-DIST.DIR COMP 3PL PRSP come.PL
 loo
 EMPH
 ‘They would prepare their things and pack them and they would leave’
- (30) gi de henua gide hoou.
 to DET island see new
 ‘for this new found island.’
- (31) Gai e dahi daane e hai bodu ange gi de hine danuaa i Saamoa
 then IPFV one man IPFV make spouse DIST.DIR to DET woman beautiful PREP Samoa
 i de masavaa laa d-ono ingoo laa go Inahia.
 PREP DET time DIST DET-3SG.GEN.O name DIST COP.FOC Inahia
 ‘And there was a man who was married to the most beautiful woman in Samoa at that
 time, whose name was Inahia.’
- (32) Gai de ingoo o de bodu o Inahia go Buasalai.
 then DET name GEN.O DET spouse GEN.O Inahia COP.FOC Buasalai
 ‘The name of Inahia’s husband was Buasalai.’

- (33) Gai Buasalai ga hai ange ga hano ga hai ange gi d-ono bodu
 then Buasalai PRSP say DIR.DIST PRSP go.SG PRSP say DIR.DIST to DET-3SG.GEN.O spouse
 go Inahia,
 COP.FOC Inahia
 ‘So Buasalai said, he went and said to his wife Inahia.’
- (34) Inahia gidaau ga loo-age loo ma dali a Vave ma d-ono huaa bodu gi
 Inahia 1DU.INCL PRSP go.PL-up EMPH with PN Vave and DET-3SG.GEN.O family to
 de henua gide houa a d-ono saulaba.
 DET island see new GEN.A DET-3SG.GEN.O in-law
 ‘Inahia, let’s go up with Vave and his family to this new island that his son-in-law found.’
- (35) Gai Inahia ga maanadu age i ono lodo i de masavaa laa bolo e
 then Inahia PRSP think up PREP 3SG.GEN.O inside PREP DET time DIST COMP IPFV
 deai ange donu se mee a Buasalai e kave laa ogu elunga
 no DIST.DIR EMPH COP.SG thing GEN.A Buasalai IPFV take DIST 1SG.GEN.O high.position
 i hongade masavaa nei i hidinga d-ogu danuaa.
 PREP top DET time PROX PREP reason DET-1SG.GEN.O beautiful
 ‘And Inahia thought at that moment, there’s nothing that Buasalai will put before me,
 because of my beauty.’
- (36) Buasalai ga dee hano naa huu au gai ia e dee hano hogi.
 Buasalai PRSP NEG go IRR when 1SG then 3SG IPFV NEG go.SG also
 ‘If I don’t go, Buasalai won’t go either.’
- (37) Gu lava ai loo gai Inahia ga noho ga hai ana lau hala e hai
 INC finish OBL EMPH then Inahia PRSP sit PRSP make 3SG.GEN.A leaf pandanus IPFV make
 ai ana hagahala.
 OBL 3SG.GEN.A sleeping.mat
 ‘So Inahia stayed and made her pandanus leaves and wove her sleeping mat.’
- (38) Gai Buasalai ga ahe mai huu i de-laau hale gu baba mee i
 then Buasalai PRSP return DIR.PROX when PREP DET-3DU.GEN house INC ready thing PREP
 de moni o Vave ma d-ono huaa bodu gai ia ga gage gi hongade
 DET canoe GEN.O Vave and DET-3SG.GEN.O family so 3SG PRSP climb to top DET
 moni o de gau laa
 canoe GEN.O DET people DIST
 ‘And Buasalai returned to their house and packed his things and went to Vave and his
 family’s canoe, and he climbed on top of their canoe’

- (39) gai gilaadeu ga loomai.
 then 3PL PRSP go.PL
 'and they left.'
- (40) Gai muli mai huu de laangi laa donu huu
 then late DIR.PROX when DET day DIST only
 'Later that same day'
- (41) gai dahi dangada ga seese adu laa gaogao de hale o Inahia ma Buasalai.
 then one person PRSP walk MED.DIR DIST side DET house GEN.O Inahia and Buasalai
 'someone walked by the house of Inahia and Buasalai.'
- (42) Inahia goi noho huu ma e hai ana lau hala
 Inahia still sit when and IPFV make 3SG.GEN.A leaf pandanus
 'Inahia was still sitting there making her pandanus leaves.'
- (43) Gai tangada ne seese adu laa ga ssili ange gi Inahia
 then DET.person PFV walk MED.DIR DIST PRSP ask DIST.DIR to Inahia,
 'So the person walked up and asked Inahia,'
- (44) Koe tee han-age ma dali Buasalai gu hano laa i de moni o Vave ma
 2SG PFV.NEG go.SG-up with Buasalai INC go.SG DIST PREP DET canoe GEN.O Vave and
 d-ono huaa bodu?
 DET-3SG.GEN.O family
 'You didn't go with Buasalai to go in the canoe of Vave and his family?'
- (45) Gai Inahia gu lele ono mouli
 then Inahia INC fly 3SG.GEN.O life
 'And Inahia was shocked'
- (46) gai ia ga haga-daba age i ono lodo i de masavaa laa,
 then 3SG PRSP CAUS-flash up PREP 3SG.GEN.O inside PREP DET time DIST
 'and she said to herself then'

- (47) D-agu bau, Buasalai gu kii loo de henua hoou d-ono lodo
 DET-1SG.GEN.A determine Buasalai INC win EMPH DET island new DET-3SG.GEN.O inside
 ai i de au i d-ogu danuaa laa i hongade masavaa nei
 OBL PREP DET 1SG PREP DET-1SG.GEN.O beautiful DIST PREP top DET time PROX
 ‘Well, I guess his desire for this new island became more important to Buasalai than his
 love for me and my beauty here’
- (48) i de henua go Saamoa.
 PREP DET island COP.FOC Samoa
 ‘on the island of Samoa.’
- (49) Ia gu tili loo au gai ia gu hano ma dali a Vave ma d-ono
 3SG INC throw.away EMPH 1SG then 3SG INC go.SG with PN Vave and DET-3SG.GEN.O
 huua bodu.
 family
 ‘He discarded me and went with Vave and his family.’
- (50) Delaa ai, de masavaa laa gai Inahia gu maanadu age i ono lodo bolo
 so DET time DIST then Inahia INC think up PREP 3SG.GEN.O inside COMP
 ia ga haga-magau ia.
 3SG PRSP CAUS-die 3SG
 ‘So then Inahia decided that she would kill herself.’
- (51) Gai ia ga poo mai d-ana dugidugi dugi lau
 then 3SG PRSP pick.up DIR.PROX DET-3SG.GEN.A pound.RED pound leaf
 ‘So she picked up her wooden pestle for pounding pandanus leaves’
- (52) gai ia ga haagaili magavaa o lu-oono mada gu magau ia ga
 then 3SG PRSP hit between GEN.O DET.DU-3SG.GEN.O eye INC die 3SG PRSP
 dagodo.
 lay
 ‘and she hit herself between the eyes and she died and laid down.’
- (53) Gai d-ono masavaa huu ne magau ai ga dagodo gai delaa ai de masavaa
 then DET-3SG.GEN.O time when PFV die OBL PRSP lay then so DET time
 denga daane ne mau ai i de hulo gi ono daha,
 DET.PL man PFV be.able OBL PREP DET go.PL to 3SG.GEN.O place
 ‘And when she died and lay there, then the men were finally able to sleep with her.’

- (54) d-ono laangi ne magau ai.
 DET-3SG.GEN.O day PFV die OBL
 'the day that she died.'
- (55) Gai denga daane ga loomai ga haga-solo dagi-dahi ange gi de ia go
 then DET.PL man PRSP come.PL PRSP CAUS-grate each-one DIR.PROX to DET 3SG COP.FOC
 Inahia gu magau.
 Inahia INC die
 'The men came and each had sex with Inahia and then died.'
- (56) Taane i mua ne ulu ga hano gi lote hale i daho Inahia gu magau
 DET.man PREP front PFV enter PRSP go.SG to inside.DET house PREP place Inahia INC die
 'The first man who went inside the house and slept with Inahia died'
- (57) gai taane i ono dua ga dada mai gi haho
 so DET.man PREP 3SG.GEN.O back PRSP pull DIR.PROX to outside
 'and the man behind him pulled him outside'
- (58) gai ia ga hano gi daho Inahia gai ia gu magau hogi.
 so 3SG PRSP go to place Inahia so 3SG INC die also
 'and he went and slept with Inahia and he died too.'
- (59) Delaa ai de-laadeu hai alodahi denga daane ne hulo gi daho Inahia i de
 so DET-3PL.GEN do all DET.PL man PFV go.PL to place.of Inahia PREP DET
 laangi laa.
 day DIST
 'So that was what happened to all the men who went to Inahia that day.'
- (60) Gilaadeu ne soa, daane ne odi ne maakau i de laangi laa i de hale
 3PL PFV many man PFV empty PFV die.PL PREP DET day DIST PREP DET house
 o Inahia ma Buasalai.
 GEN.O Inahia and Buasalai
 'Many men died that day at the house of Inahia and Buasalai.'
- (61) Gai dahi dangada ga haga-dele adu ga langona e de hodooligi i Saamoa
 then one person PRSP CAUS-sail DIR.MED PRSP listen.CIA ERG DET king PREP Samoa
 'So one person spread the word and the king heard'

- (62) de longo laa.
 DET news DIST
 ‘the news.’
- (63) Gai de hodooligi i Saamoa ga haga-noho mai de hulo o daane o
 then DET king PREP Samoa PRSP CAUS-sit DIR.PROX DET go.PL GEN.O man GEN.O
 d-ono henua gi dahō de hine go Inahia
 DET-3SG.GEN.O island to place.of DET woman COP.FOC Inahia
 ‘Then the Samoan king stopped men from going to where Inahia was.’
- (64) Delaa ai de masavaa ne... de hodooligi ne haga-noho mai ai gai gu soa
 so DET time PFV DET king PFV CAUS-sit DIR.PROX OBL then INC many
 daane ne maagau
 men PFV die.PL
 ‘But by the time the king stopped it, many men had died’
- (65) i dahō Inahia, gu lava ai loo.
 PREP place Inahia INC finish OBL EMPH
 ‘at the home of Inahia. It was over.’
- (66) Gu lava de masavaa ne pono mai ai laa de hodooligi i Saamoa ne daohi
 INC finish DET time PFV close DIR.PROX OBL DIST DET king PREP Samoa PFV keep
 ai daane o d-ono henua, gu deai ange daane e hulo gi dahō
 OBL man GEN.O DET-3SG.GEN.O island INC no DIR.DIST man IPFV go.PL to place.of
 Inahia gai Inahia ga doo-ange i de laangi laa.
 Inahia then Inahia PRSP fall-DIR.DIST PREP DET day DIST
 ‘When it was stopped, when the king stopped the men of his island, there were no more
 men who went to Inahia, and Inahia was buried that day.’
- (67) Be dehee, de-laa naa de-laadeu hai ne do-ange ai Inahia i
 like how DET-DIST MED DET-3PL.GEN way PFV fall-DIR.DIST RES.PR Inahia PREP
 d-ono magau laa ga dugu.
 DET-3SG.GEN.O die DIST PRSP put
 ‘How then, that’s how they buried Inahia after her death.’

- (68) Delaa ai, de laangi ne lilo ai de hine danuaa i de masavaa laa
 DET-DIST OBL DET day PFV disappear OBL DET woman beautiful PREP DET time DIST
 i Saamoa go Inahia laa d-ono ingoo.
 PREP Samoa COP.FOC Inahia DIST DET-3SG.GEN.O name
 ‘So that’s the day that she was gone forever, the most beautiful woman in Samoa at that
 time, whose name was Inahia.’
- (69) Gai Buasalai gu dae mai gi de henua hoou a Gaeuli ne gide laa a
 then Buasalai INC reach DIR.PROX to DET island new GEN.A Gaeuli PFV see DIST GEN.A
 Vave ne maanadu age laa bolo gilaadeu ma d-ono huaabodu ga loomai
 Vave PFV think up DIST COMP 3PL and DET-3SG.GEN.O family PRSP come.PL
 loo gi agina.
 EMPH to there
 ‘So Buasalai arrived at the new island that Gaeuli discovered, which Vave decided that his
 family would go to.’
- (70) A Vave ma d-ono huaa bodu, de-laadeu moni ne loomai ai gi de henua
 PN Vave and DET-3SG.GEN.O family DET-3PL.GEN canoe PFV come.PL OBL to DET island
 nei se haolua.
 PROX COP.SG double.hulled.canoe
 ‘Vave and his family, their canoe that came to the island was a haolua.’
- (71) E lua moni, ga huuhuli ange luu gadea gi lodo gai luu
 IPFV two canoe PRSP turn.PL DIR.DIST DET.DU non.outrigger.side to inside then DET.DU
 ama i daha
 outrigger.float PREP outside
 ‘It’s two canoes, turned so the flat sides of the canoe are on the inside and the two outrig-
 ger floats are on the outside.’
- (72) Ga haga-duu ai, ange gi agina de... togoduu.
 PRSP CAUS-stand OBL DIR.DIST to there DET togoduu
 ‘and they put the togoduu on it.’
- (73) De ingoo de hale se togoduu,
 DET name DET house COP.SG togoduu
 ‘The name of the house (on the boat) is togoduu.’
- (74) gai de ingoo o de moni, haolua.
 then DET name GEN.O DET canoe double.hulled.canoe
 ‘and the name of the canoe, haolua.’

- (75) Gilaadeu ga nnoho ai loo i de henua nei.
 3PL PRSP live.PL OBL EMPH PRSP DET island PROX
 ‘So they lived here on this island.’
- (76) Gilaadeu ga nnoho nnoho nnoho nnoho huu i de henua nei, gu kii taina
 3PL PRSP live.PL live.PL live.PL live.PL when PREP DET island PROX INC win DET.sibling
 o Gaubogo, i Gaubogo.
 GEN.O Gaubogo PREP Gaubogo
 ‘As they lived on this island for a while, Gaubogo’s sister began to win out over Gaubogo.’
- (77) D-ono daina hahine, d-ono ingoo go Gausugilogo.
 DET-3SG.GEN.O sibling woman DET-3SG.GEN.O name COP.FOC Gausugilogo
 ‘Her sister, her name was Gausugilogo.’
- (78) Gai ia ga kave a Vave, ga hai bodu gilaau.
 then 3SG PRSP take PN Vave PRSP make spouse 3DU
 ‘She took Vave, and they got married.’
- (79) Ga nnoho ai i de henua nei. Gai Gaubogo, lodo baubau.
 PRSP live.PL OBL PREP DET island PROX then Gaubogo want bad
 ‘And they stayed on this island. But Gaubogo was upset.’
- (80) D-ana maanadu bolo, go ono hidingane hidi ai laa, de humai
 DET-3SG.GEN.A think COMP COP.FOC 3SG.GEN.O reason PFV cause OBL DIST DET come.SG
 o d-ono daina go Gausugilogo gi de henua nei.
 GEN.O DET-3SG.GEN.O sibling COP.FOC Gausugilogo to DET island PROX
 ‘She thought that it was because of her that her sister Gausugilogo was able to come to this island.’
- (81) Gai ga tae mai huu gilaadeu, gai Gausugilogo ga vaivai hai ia
 then PRSP reach.PL DIR.PROX huu 3PL then Gausugilogo PFV disappoint 3SG
 ‘But when they arrived, Gausugilogo really disappointed her’
- (82) ga kave d-ono bodu go Vave.
 PRSP take DET-3SG.GEN.O spouse COP.FOC Vave
 ‘by marrying her husband, Vave’

- (83) Go gilaau gu nnoho i de masavaa laa.
 COP.FOC 3DU INC live.PL PREP DET time DIST
 ‘And they started living together then.’
- (84) Gai de-laa de-laadeu dagodo.
 then DET-DIST DET-3PL.GEN situation
 ‘So that’s how they were.’
- (85) Ga nnoho laa Gausugilogo ma Vave gai Gaubogo gu hano ma e noho i
 PRSP live.PL DIST Gausugilogo and Vave then Gaubogo INC go.SG and IPFV sit PREP
 dua Saboganga ma e nanu ai.
 back Saboganga and IPFV complain OBL
 ‘When Gausugilogo and Vave lived together, Gaubogo went to the ocean-side of Sabo-
 ganga and criticized them.’
- (86) De-laa d-ana kumi age bolo de soe mai ono henua.
 DET-DIST DET-3SG.GEN.A estimate up COMP DET straight DIR.PROX 3SG.GEN.O island
 ‘There she figured that she was facing her island.’
- (87) aagai de madaa gai a de henua e gaa-mai gi a Vave de baasi laumalie gai
 then DET first food GEN.A DET island IPFV bring to PN Vave DET side big so
 a Vave ga kave gi Gaubogo go d-ono bodu donu iai laa ana
 PN Vave PRSP give to Gaubogo COP.FOC DET-3SG.GEN.O spouse true there DIST 3SG.GEN.A
 dama
 children
 ‘So when the first harvest of the island was brought to Vave, Vave gave the biggest portion
 to Gaubogo, his true wife, who had his children’
- (88) hidinga de maanadu a Vave ne hai ai laa be laa go hidinga bolo i
 because DET think GEN.A Vave PFV do OBL DIST like DIST COP.FOC reason COMP PREP
 a Vave de-laa de hine ne hai ai d-ono aamuli,
 PN Vave DET-DIST DET woman PFV make OBL DET-3SG.GEN.O descendant
 ‘and the reason why Vave decided to do that is because in Vave’s eyes, that was the woman
 who had created his descendants,’
- (89) go Gaubogo.
 COP.FOC Gaubogo
 ‘Gaubogo.’

- (90) De-laa donu de hagasaele danuaa ma de heohi a Vave ne hai ai laa
 DET-PROX truly DET think/decide good and DET correct GEN.A Vave PFV do OBL DIST
 be laa de hai daina go Gaubogo ma Gausugilogo.
 like DIST DET make sibling COP.FOC Gaubogo and Gausugilogo
 ‘That was the best that Vave could do for the sisters Gaubogo and Gausugilogo.’
- (91) Gai ga gidee huu a Gausugilogo de hai a Vave e hai ai gilaa
 then PRSP see when PN Gausugilogo DET way GEN.A Vave IPFV do/make OBL 3DU
 ma d-ono daina gai gu ni-oono de bodu go Vave i de
 and DET-3SG.GEN.O sibling then INC COP.PL-3SG.GEN.O DET spouse COP.FOC Vave PREP DET
 masavaa laa
 time DIST
 ‘When Gausugilogo realized how Vave was treating her and her sister, even though Vave
 was her husband at that time,’
- (92) gai ia gu lodo baubau gai ia ga haga-daba age i ono lodo,
 then 3SG INC want bad so 3SG INC CAUS-flash up PREP 3SG.GEN.O inside
 ‘she became upset, and she said to herself,’
- (93) Aha laa? Dehee tagodo a Vave gu hai ai nei au be nei?
 what DIST how DET.situation GEN.A Vave INC do OBL PROX 1SG like PROX
 ‘What? How could Vave do this to me?’
- (94) Go gimaau gu hai bodu iainei gai de madaa gai a de henua e
 COP.FOC 1DU.INCL INC do/make spouse now so DET first food GEN.A DET island IPFV
 gaa-mai gi de ia gai ia e kave de baasi laumalie gi Gaubogo.
 bring to DET 3SG then 3SG IPFV take DET side big to Gaubogo
 ‘We are now husband and wife, but of the first fruits of the island that are brought to him,
 he gives the larger portion to Gaubogo.’
- (95) Gai e dee iloo ange ia be dehee d-ana hai e hai ai hidinga
 then IPFV NEG know DIR.DIST 3SG like how DET-3SG.GEN.A way IPFV do OBL because
 a-laa donu lodo o Vave.
 PL-DIST EMPH want GEN.O Vave
 ‘And she couldn’t do anything about it, because those were Vave’s wishes.’

- (96) De madaa gai laumalie a de henua e gaa-mai gi de ia e kave gi
 DET first fruit big GEN.A DET island IPFV bring-DIR.PROX to DET 3SG IPFV take to
 d-ono bodu iai laa d-ono aamuli.
 DET-3SG.GEN.O spouse have DIST DET-3SG.GEN.O descendant
 ‘Most of the first fruits of the island that were brought to him were given to his wife who
 had his children.’
- (97) Gilaaau ga nnoho ai loo i dahi laangi
 3DU PRSP live.PL OBL EMPH PREP one day
 ‘They were living there one day.’
- (98) ga nnoho nnoho huu gilaadeu i de henua nei
 PRSP live.PL live.PL when 3PL PREP DET island PROX
 ‘as they continued to stay on this island.’
- (99) gu hanu dama a Iaidemalo ma d-ono bodu.
 INC some children GEN.A Iaidemalo and DET-3SG.GEN.O spouse
 ‘Iaidemalo and his wife had children.’
- (100) De ingoo o de bodu o Iaidemalo, Leibua.
 DET name GEN.O DET spouse GEN.O Iaidemalo Leibua
 ‘The name of Iaidemalo’s wife was Leibua.’
- (101) Gai alaaau dama daane dogo-dolu.
 then 3DU.GEN.A child man CL.HUM-three
 ‘They had three sons.’
- (102) Tama madua d-ono ingoo go Hagadauanga,
 DET.child old DET-3SG.GEN.O name COP.FOC Hagadauanga
 ‘The oldest child’s name was Hagadauanga.’
- (103) gai tama i ono lalo go Dehegevaealigi,
 then DET.child PREP 3SG.GEN.O below COP.FOC Dehegevaealigi
 ‘the child below him was Dehegevaealigi.’
- (104) gai tamaa gauligi go Dehuemalaedoli.
 then DET.child young COP.FOC Dehuemalaedoli
 ‘and the youngest child was Dehuemalaedoli.’

- (105) A-nei ingoo denga dama daane dogo-dolu a Iaidemalo,
 PL-PROX name DET.PL child man CL.HUM-three GEN.A Iaidemalo
 ‘Those are the names of the three sons of Iaidemalo,’
- (106) go dahi luu dama daane a Vave laa.
 COP.FOC one DET.DU child man GEN.A Vave DIST
 ‘one of Vave’s two sons.’
- (107) aagai a Deagu, teai s-ana dama.
 so PN Deagu PFV.no COP.SG-3SG.GEN.A child
 ‘And Deagu didn’t have any children.’
- (108) Gilaadeu e nnoho ai huu, gu dahi Hagadauanga i mua.
 3PL IPFV live.PL OBL when INC one Hagadauanga PREP first
 ‘While they lived on Nukuoro, Hagadauanga was born first.’
- (109) Gai gilaadeu ga haele haele haele haele huu gu madua loo goe
 then 3PL PRSP bring.up bring.up bring.up bring.up when INC old EMPH 2SG
 Hagadauanga
 Hagadauanga
 ‘They raised him until he was older’
- (110) gu iloo ia i de tilo ange ia sogosogo.
 INC know 3SG PREP DET look.at DIR.DIST 3SG alone
 ‘until he knew how to look after himself.’
- (111) Gilaadeu ga nnoho ai loo
 3PL PRSP live.PL OBL EMPH
 ‘They continued to live there’
- (112) hano hano huu dahi laangi gai gu daamada age hogi de hai dama o de
 go.SG go.SG when one day then INC begin up also DET make child GEN.O DET
 bodu o Iaidemalo.
 spouse GEN.O Iaidemalo
 ‘and then one day, Iaidemalo’s wife got pregnant aagain.’
- (113) Ga hano hano huu gu dae gi d-ono laangi ne haanau ai,
 PRSP go.SG go.SG when INC reach to DET-3SG.GEN.O day PFV give.birth OBL
 ‘And the day came that she gave birth,’

- (114) de laangi o Leibua ne haanau ai,
 DET day GEN.O Leibua PFV give.birth OBL
 ‘the day that Leibua gave birth,’
- (115) ga haanau mai huu Leibua se gauligi daane ange hogi.
 PRSP give.birth DIR.PROX when Leibua COP.SG child male DIR.DIST also
 ‘and when Leibua gave birth, it was a baby boy aagain.’
- (116) Gai lu-oono maadua gaav-ange d-ono ingoo go
 then DET.DU-3SG.GEN.O parent give-DIR.DIST DET-3SG.GEN.O name COP.FOC
 Dehegevaealigi.
 Dehegevaealigi
 ‘and his parents named him Dehegevaealigi.’
- (117) Dehegevaealigi d-ono hagadoonunga se hagasaalunga,
 Dehegevaealigi DET-3SG.GEN.O meaning COP.SG spirit
 ‘Dehegevaealigi means spirit,’
- (118) go de hagasaalunga o denga aligi. De baasi o denga aligi laa.
 COP.FOC DET spirit GEN.O DET.PL priest DET side gen DET.PL priest DIST
 ‘the spirit of the priests. The clan of the priests.’
- (119) De-laa ne vange laa gi togo-lua dama a Iaidemalo.
 DET-DIST PFV give DIST to DET.CL.HUM-two child GEN.A Iaidemalo
 ‘That was given to the second son of Iaidemalo.’
- (120) Gai gilaadeu ga tilo ange ga haele
 then 3PL PRSP look.at DIR.DIST PRSP bring.up
 ‘So they looked after him and raised him’
- (121) ga nnoho ai gilaadeu
 PRSP live.PL OBL 3PL
 ‘and they lived there’
- (122) ga tilo tilo ange huu gu madua loo hogi Dehegevaealigi
 PRSP look.at look.at DIR.DIST when INC old EMPH also Dehegevaealigi
 ‘and looked after him until Dehegevaealigi also grew up’

- (123) ga lava gu iloo ia i de tilo ange donu huu ia sogosogo.
 PRSP finish INC know 3SG PREP DET look.at DIR.DIST only 3SG alone
 ‘and he knew how to take care of himself.’
- (124) Gilaadeu ga nnoho ange ai loo hogi.
 3PL PRSP live.PL DIR.DIST OBL EMPH also
 ‘So they continued to live there.’
- (125) Damaa nnoho ange huu muli mai ange gu hai dama ange loo hogi
 little live.PL DIR.DIST when after DIR.PROX DIR.DIST INC make child DIR.DIST EMPH also
 Leibua.
 Leibua
 ‘They lived for a little while, and after some time, Leibua became pregnant aagain.’
- (126) Gai damaa nnoho ange huu gilaadeu, gu haanau loo hogi Leibua
 then little live.PL DIR.DIST when 3PL INC give.birth EMPH also Leibua
 ‘And after a little while, Leibua gave birth aagain’
- (127) i tama haga-odi.
 PREP DET.child CAUS-empty
 ‘to the last child.’
- (128) Ga haanau huu, de laangi ne haanau mai ai, gai lu-oono
 PRSP give.birth when DET day PFV give.birth DIR.PROX OBL then DET.DU-3SG.GEN.O
 maadua gaav-ange hogi d-ono ingoo go Dehuemalaedoli.
 parent give-DIR.DIST also DET-3SG.GEN.O name COP.FOC Dehuemalaedoli
 ‘When he was born, the day he was born, his parents gave him the name Dehuemalaedoli.’
- (129) Gai gilaadeu ga tilo ange
 then 3PL PRSP look.at DIR.DIST
 ‘So they looked after him’
- (130) haele haele gu iloo hogi e ia i de tilo sogosogo ange ia.
 bring.up bring.up INC know also ERG 3SG PREP DET look.at alone DIR.DIST 3SG
 ‘and raised him and raised him until he knew how to look after himself.’
- (131) De-naa ai de odi dama a Iaidemalo ma Leibua.
 DET-MED OBL DET empty child GEN.A Iaidemalo and Leibua
 ‘That was the last child of Iaidemalo and Leibua.’

- (132) E dogo-dolu alaau dama daane.
 IPFV CL.HUM-three 3DU.GEN.A child male
 ‘They had three sons.’
- (133) Gai dahi laangi huu gai Dehuemalaedoli ga humai gi daho lu-oono
 then one day when then Dehuemalaedoli PRSP come.SG to place.of DET.DU-3SG.GEN.O
 dubuna
 grandparent
 ‘So one day, Deheumalaedoli came to his two grandparents’
- (134) go Vave ma Gausugilogo
 COP.FOC Vave and Gausugilogo
 ‘Vave and Gausugilogo’
- (135) gai lu-oono dubuna gu llo do danuaa.
 so DET.DU-3SG.GEN.O grandparent INC want.PL good
 ‘and his two grandparents were happy.’
- (136) Gilaa gu malangilangi i de humai o de-laau mogobuna gi olaau
 3DU INC happy PREP DET come.SG GEN.O DET-3DU.GEN grandchild to 3DU.GEN.O
 dahi i de masavaa laa.
 place.of PREP DET time DIST
 ‘They were happy that their grandchild came to see them at that time.’
- (137) Gai tubuna hahine go Gausugilogo ga gaa-mai ga
 then DET.grandparent female COP.FOC Gausugilogo PRSP bring-DIR.PROX PRSP
 haga-dagodo i hong a lu-oono vae ga viivii ai,
 CAUS-lay PREP top DET.DU-3SG.GEN.O leg PRSP rock OBL
 ‘Then his grandma Gausugilogo took him and laid him on her lap and rocked him,’
- (138) viivii ai Dehuemalaedoli.
 rock OBL Dehuemalaedoli
 ‘rocked Dehuemalaedoli.’
- (139) Gai e dahi gubu daahili o Vave e hai ange bolo “E hau sogo Vave gi
 then IPFV one phrase song GEN.O Vave IPFV say DIR.DIST COMP IPFV ?? ?? Vave to
 d-ono henua.”
 DET-3SG.GEN.O island
 ‘And there was a phrase of a song about Vave called “E hau sogo Vave gi dono henua.”’

- (140) Gai de laangi nei huu gai Gausugilogo ga galo adu huu a Logo e
 then DET day PROX when then Gausugilogo PRSP look DIR.MED when PN Logo IPFV
 noho mai e sula mai gi de ia de momme o Logo e noho ai.
 sit DIR.PROX IPFV appear DIR.PROX to DET 3SG DET place GEN.A Logo IPFV live OBL
 ‘And that day Gausugilogo looked and saw Logo sitting there, she could see the place
 where Logo was sitting.’
- (141) E he-baa olaadeu hale. A Logo se daane
 IPFV RCPR-close.by 3PL.GEN.O house PN Logo COP.SG man
 ‘Their houses were close. Logo was a man’
- (142) go tamana o Leibua, de bodu o Iaidemalo.
 COP.FOC DET.father GEN.O Leibua DET spouse GEN.O Iaidemalo
 ‘the father of Leibua, Iaidemalo’s wife.’
- (143) Gai Gausugilogo gu manadua age e ia i de laangi laa de kai aneane i
 then Gausugilogo INC think up ERG 3SG PREP DET day that DET tale comfort PREP
 ono lodo bolo ia ga hadu ange dahi gubu daahili mo Logo e
 3SG.GEN.O inside COMP 3SG PRSP compose DIR.DIST one phrase song BEN.O Logo IPFV
 viivii ai d-ono mogobuna go Dehuemalaedoli.
 rock OBL DET-3SG.GEN.O grandchild COP.FOC Dehuemalaedoli
 ‘So Gausugilogo, she thought that day of a lullaby, that she would compose a verse of a
 song in honor of Logo, to sing while rocking her grandchild Dehuemalaedoli.’
- (144) Gai ia ga daamada de hua d-ana gubu daahili ne hadu i de
 then 3SG PRSP begin DET sing DET-3SG.GEN.A phrase song PFV compose PREP DET
 masavaa laa donu huu
 time DIST only
 ‘So she began to sing her song that she composed just then’
- (145) ga hai ai bolo, “E hau sogo Logo gi d-ono henua.”
 PRSP make OBL COMP IPFV ?? ?? Logo to DET-3SG.GEN.O island
 ‘and called it “E hau sogo Logo gi dono henua.”’
- (146) Gai a Vave e noho ange donu huu i de gaogao o Gausugilogo
 then PN Vave IPFV live DIR.DIST only PREP DET side GEN.O Gausugilogo
 ‘But Vave was sitting right by Gausugilogo’s side’

- (147) gai a Vave gu han-age de maagoda i ono lodo i de masavaa laa
 then PN Vave INC go.SG-up DET jealous PREP 3SG.GEN.O inside PREP DET time DIST
 ‘and Vave became filled with jealousy at that time’
- (148) gai ia gu lili.
 then 3SG INC angry
 ‘and he became angry.’
- (149) Gai ia ga haga-ago lu-oono daagami gi hulo gi velosia,
 then 3SG PRSP CAUS-teach DET.DU-3SG.GEN.O bodyguard SBJV come.PL SBJV pierce.CIA
 daaloa a Logo i tao.
 stab.CIA PN Logo PREP DET.spear
 ‘So he told his two guards to come and stab Logo with a spear.’
- (150) Gai lu-oono daagami ga loo-adu ma lu-oolaa dao
 then DET.DU-3SG.GEN.O bodyguard PRSP come.PL-DIR.MED and DET.DU-3DU.GEN.O spear
 e hulo e daalo ai a Logo.
 IPFV go.PL IPFV stab OBL PN Logo
 ‘So his two guards came with their spears to come and stab Logo.’
- (151) Gai ga loo-adu huu gilaa, gai Iaidemalo e dagodo donu be ia e
 then PRSP come.SG-DIR.MED when 3DU then Iaidemalo IPFV seem EMPH like 3SG IPFV
 iloo laa hidinga o luu daagami o d-ono damana ne loo-adu ai
 know DIST reason GEN.O DET.DU soldier GEN.O DET-3SG.GEN.O father PFV come OBL
 laa, se loo-adu e daalo a Logo i olaau dao.
 DIST COP.SG come IPFV stab PN Logo PREP 3DU.GEN.O spear
 ‘So when they came, Iaidemalo seemed to understand why his father’s two guards came,
 it was to stab Logo with their spears.’
- (152) Gai Iaidemalo ga ssili ange gi luu daagami o d-ono damana,
 then Iaidemalo PRSP ask DIR.DIST to DET.DU guard GEN.O DET-3SG.GEN.O father
 ‘So Iaidemalo asked his father’s two guards,’
- (153) Se loomai naa gooluu e aha?
 COP.SG come.PL MED 2DU IPFV what
 ‘Why have you come?’
- (154) Gai luu daagami ga pasa ange ga hai ange,
 then DET.DU guard PRSP speak.PL DIR.DIST PRSP say DIR.DIST
 ‘And the two guards answered him, saying,’

- (155) Bolo i a Vave, gimaau gi loomai gi daaloa a Logo gi magau.
say PREP PN Vave 1DU.EXCL SBJV come SBJV stab.CIA PN Logo SBJV die
'Vave told us to come and stab Logo to death.'
- (156) Gai Iaidemalo ga hai ange gi luu daagami o d-ono damana,
then Iaidemalo PRSP say DIR.DIST to DET.DU guard GEN.O DET-3SG.GEN.O father
'And Iaidemalo told his father's two guards'
- (157) Gooluu aahe gi d-ooluu momme ne loomai ai naa.
2DU return.PL to DET-2SG.GEN place PFV come.PL OBL MED
'You two, go back to where you came from.'
- (158) Gai luu daagami gu maatagu i de muna a Iaidemalo e hai ange gi
then two guard INC scared.PL PREP DET word GEN.A Iaidemalo IPFV say DIR.DIST to
gilaau.
3DU
'And the two guards were scared of what Iaidemalo said to them.'
- (159) Gai gilaau ga aahe gi daho Vave gai a Vave ga ssili ange,
then 3DU PRSP return.PL to place.of Vave then PN Vave PRSP ask DIR.DIST
'So they returned to Vave and Vave asked them,'
- (160) Gu aha gu aahe mai ai laa gooluu gu tee daalo ai laa a Logo gi
why INC return.PL DIR.PROX OBL DIST 2DU INC PFV.NEG stab OBL DIST PN Logo SBJV
moolau de magau?
quick DET die
'Why did you return here without stabbing Logo to die right away?'
- (161) Gai luu daagami ga hai ange gi a Vave,
then DET.DU guard PRSP say DIR.DIST to PN Vave
'And the two guards said to Vave,'
- (162) Hidinga gimaau gu maatagu i Iaidemalo e hai mai bolo gimaau gi
because 1DU.EXCL INC scared.PL PREP Iaidemalo IPFV say DIR.DIST COMP 1DU.EXCL to
aahe mai gi de-maau momme ne loo-adu ai.
return.PL DIR.PROX to DET-1DU.EXCL.GEN place PFV come.PL-DIR.MED OBL
'Because we were afraid of Iaidemalo, who said that we should go back to where we came from.'

- (163) Gai gilaau ga damaa nnoho iho gi lalo dahi masavaa bodobodo.
 then 3DU PRSP little sit.PL down to below one time short
 ‘Then they sat down for a short moment.’
- (164) Gai a Vave ga hai ange,
 then PN Vave PRSP say DIR.DIST
 ‘And Vave said,’
- (165) Gooluu hulo ma gi mmuni i dahi haiava gee ange ma gi hulo ai
 2DU go.PL and SBJV hide PREP one road away DIR.DIST and SBJV go.PL OBL
 ‘You two, go and hide on a different road and go’
- (166) daaloo a Logo gi moolau d-ono magau.
 stab.CIA PN Logo SBJV quick DET-3SG.GEN.O die
 ‘stab Logo so that he dies quickly.’
- (167) Gilaaau ga aahe
 3DU PRSP return.PL
 ‘They returned’
- (168) ga hai gi bei muna a Vave ne hai ange gi gilaau.
 PRSP do to like word GEN.A Vave PFV say DIR.DIST to 3DU
 ‘and did as Vave told them.’
- (169) Gilaaau ga aahe adu, go mee mau.
 3DU PRSP return.PL DIR.MED COP.FOC thing usual
 ‘When they returned, the same thing happened.’
- (170) Iaidemalo e iloo ia
 Iaidemalo IPFV know 3SG
 ‘Iaidemalo knew’
- (171) hidinga o luu daagami ne loo-adu ai laa.
 reason GEN.O DET.DU guard PFV come.PL-DIR.MED OBL DIST
 ‘why the two guards came.’
- (172) Gai ia ga alualu ange hogi luu daagami i de hanonga laa
 then 3SG PRSP banish DIR.DIST also DET.DU guard PREP DET iteration DIST
 ‘So he banished the two guards again that time.’

- (173) Gilaaau ga aahe mai
 3DU PRSP return.PL DIR.PROX
 ‘They returned’
- (174) ga aahe mai ai huu, teai ange ai loo muna a Vave ne hai
 PRSP return.PL DIR.PROX OBL when PFV.no DIR.DIST OBL EMPH word GEN.A Vave PFV say
 ange gi gilaaau bolo gilaaau gi hai, gi haia i de masavaa laa.
 DIR.DIST to 3DU COMP 3DU SBJV do SBJV do.CIA PREP DET time DIST
 ‘and when they returned, Vave gave no more instructions for what they should do then.’
- (175) Gilaaau ga nnoho ai donu huu.
 3DU PRSP live.PL OBL only
 ‘So they just stayed.’
- (176) Gai dahi laangi huu, i muli mai de laangi nei,
 then one day when PREP later DIR.PROX DET day PROX
 ‘Then one day later on, on that day,’
- (177) Gai Leibua, gu hano gi lote husi, e hai ai de-laadeu haga-mouli
 then Leibua INC go.SG to inside.DET taro.patch IPFV do OBL DET-3PL.GEN CAUS-live
 ‘Leibua went to the taro patch to pick taro’
- (178) e gaamai, e gai mee ai gilaadeu.
 IPFV bring IPFV eat thing OBL 3PL
 ‘and bring it for them to eat.’
- (179) Gai Iaidemalo, e noho huu i de-laau hale.
 then Iaidemalo IPFV live when PREP DET-3DU.GEN house
 ‘Iaidemalo was still at their house.’
- (180) Gai Iaidemalo, gu han-age i ono lodo i de masavaa laa i de
 then Iaidemalo INC go.SG-up PREP 3SG.GEN.O inside PREP DET time DIST PREP DET
 laangi laa donu huu hogi, bolo ia ga aalu d-ono bodu go Leibua
 day DIST truly also COMP 3SG PRSP send.for DET-3SG.GEN.O spouse COP.FOC Leibua
 gi lote husi
 to inside.DET taro.patch
 ‘So Iaidemalo decided at that moment on that day also, that he would send for his wife
 Leibua in the taro patch’

- (181) gi daa-ngia de oo ma gi humai ai.
 SBJV pick-CIA DET ration and SBJV come.SG OBL
 'to pick a supply of food and return home.'
- (182) E hulo ai gilaadeu, e hagaholau.
 IPFV go.PL OBL 3PL IPFV exile
 'They were to leave, and never return.'
- (183) Gai Leibua goi hai huu ana mee i lote husi.
 then Leibua CONT do when 3SG.GEN.A thing PREP inside.DET taro.patch
 'And Leibua was still doing her work in the taro patch.'
- (184) Gai de masavaa huu, ne dangi ai de buu, o de hagaholau, gai Leibua gu
 then DET time when PFV cry OBL DET shell GEN.O DET exile then Leibua INC
 lele ono mouli.
 jump 3SG.GEN.O life
 'So at that time, when the conch shell sounded the call of exile, Leibua was shocked.'
- (185) Dee iloo e ia be ahee hidinga, gu hagaholau ai laa gilaadeu i de laangi
 NEG know ERG 3SG if which reason INC exile OBL DIST 3PL PREP DET day
 laa.
 DIST
 'She didn't know why they would leave forever that day.'
- (186) Gai ia ga humai gi moolau. Ga gaa-mai de oo, ga humai ai.
 then 3SG PRSP come SBJV quick PRSP bring DET ration PRSP come OBL
 'So she came quickly. She brought the rations and came home.'
- (187) De muna, e hai ange laa bolo de oo, d-ono hagadoonunga, go
 DET word IPFV say DIR.DIST DIST COMP DET ration DET-3SG.GEN.O meaning COP.FOC
 de mada baabaa.
 DET front flat
 'The word *oo*, it refers to the cut (harvested) taro.'
- (188) De-laa de mee e hagaholau ai, dangada gi hulo gi daha ma de henua.
 DET-DIST DET thing IPFV exile OBL person SBJV go.PL to outside and DET island
 'That is what *hagaholau* is, when people are going out away from the island.'

- (189) Gai ia ga humai ga dae mai gi daho d-ono bodu ma
 then 3SG PRSP come.SG PRSP reach DIR.PROX to place.of DET-3SG.GEN.O spouse and
 d-ono damana i de-laadeu hale
 DET-3SG.GEN.O father PREP DET-3PL.GEN house
 ‘So she came and reached her husband and her father at their house’
- (190) ma alaau dama dogo-dolu.
 and 3PL.GEN.A child CL.HUM-three
 ‘and their three children.’
- (191) Gai laidemalo ga basa ange gi Leibua ga hai ange,
 so laidemalo PRSP talk DIR.DIST to Leibua PRSP say DIR.DIST
 ‘And laidemalo talked to Leibua and said’
- (192) Doo-ange ina loo odaadeu mee, gidaadeu ga hulo loo
 fall-DIR.DIST INA EMPH 1PL.INCL.GEN.O thing 1PL.INCL PRSP go.PL EMPH
 ‘Pack up our things, we have to leave.’
- (193) hidinga d-ogu damana e lodo e daa d-oo damana gi moolau,
 because DET-1SG.GEN.O father IPFV want IPFV kill DET-2SG.GEN.O father EMPH quick
 donu d-ono dee maleva i odaadeu daha.
 truly DET-3SG.GEN.O NEG present PREP 1PL.INCL.GEN.O place
 ‘because my father wants to kill your father quickly, so he cannot be with us anymore.’
- (194) Gai Leibua ga hagdaba age i ono lodo i de masavaa laa bolo, henua
 then Leibua PRSP decide up PREP 3SG.GEN.O inside PREP DET time DIST COMP island
 o dangada, gai goi Leibua.
 GEN.O person then still Leibua
 ‘So Leibua decided at that time that she was a stranger on somebody else’s island.’
- (195) Tagodo o lote muna a Leibua laa, e hai ange bolo noo go
 DET.state GEN.O inside.DET word GEN.A Leibua DIST IPFV say DIR.DIST COMP if COP.FOC
 d-ono henua naa donu oona e noho ai, e deai donu mee be laa,
 DET-3SG.GEN.O island MED truly 3SG.GEN.A IPFV live OBL IPFV no truly thing like DIST
 ne hai ange gi de ia i de laangi laa.
 PFV say DIR.DIST to DET 3SG PREP DET day DIST
 ‘The meaning of what Leibua is saying is like this: if she lived on her own island, nothing
 like that would have happened to her on that day.’

- (196) Gai go hidinga, go henua o dangada, de-laa oona e noho ai
 then COP.FOC reason COP.FOC island GEN.O person DET-DIST 3SG.GEN.A IPFV live OBL
 laa i de masavaa laa, aalaa ai hidinga oona ne alu-mia adu ai
 DIST PREP DET time DIST those OBL reason 3SG.GEN.A PFV send.for-CIA DIR.MED OBL
 laa gi lote husi i de laangi laa.
 DIST to inside.DET taro.patch PREP DET day DIST
 ‘Because the island she was living on at that time belongs to other people. That’s why she
 was called to return home from the taro patch that day.’
- (197) Gai ia ga humai ai laa, ga dae mai, ga iloo bolo go hidinga
 then 3SG PRSP come.SG OBL DIST PRSP reach DIR.PROX PRSP know COMP COP.FOC reason
 o d-ono damana ne hidi ai laa, de-laadeu hagaholau i de laangi
 GEN.O DET-3SG.GEN.O father PFV cause OBL DIST DET-3PL.GEN exile PREP DET day
 laa.
 DIST
 ‘So she came and reached home, and knew that it was because of her father that they had
 to leave that day.’
- (198) Gai ia ga hai gi bei muna a Iaidemalo ne hai ange gi de ia.
 then 3SG PRSP do to like word GEN.A Iaidemalo PFV say DIR.DIST to DET 3SG
 ‘So she did what Iaidemalo had told her.’
- (199) Ga doo-ange olaadeu mee ga hagadabena gi danuaa ga solo de-laadeu
 PRSP fall-DIR.DIST 3PL.GEN.O thing PRSP prepare to good PRSP grate DET-3PL.GEN
 vaga gi dai.
 canoe to lagoon
 ‘She packed their things and prepared everything and dragged their canoe to the shore.’
- (200) Gai ga molimoli iho olaadeu golea, gi hongga de-laadeu vaga.
 then PRSP carry.RED down 3PL.GEN.O supplies to top DET-3PL.GEN canoe
 ‘Then she carried their supplies onto their canoe.’
- (201) Gu odi iho olaadeu golea, gai Iaidemalo ga maanadu age i de masavaa
 INC empty down 3PL.GEN.O supplies then Iaidemalo PRSP think up PREP DET time
 laa,
 DIST
 ‘When their supplies were loaded, Iaidemalo thought at that time.’

- (202) Au ga gaav-ange nei loo d-agu damaa gauligi gi noho i dahō
 1SG PRSP give-DIR.DIST PROX EMPH DET-1SG.GEN.A child young SBJV live PREP place.of
 d-ogu damana, e sui ai au, gai au ga hano nei loo ma
 DET-DET-1SG.GEN.O father IPFV replace OBL 1SG so 1SG PRSP go.SG PROX EMPH and
 dogu bodu, ma tamana o dogu bodu.
 DET-1SG.GEN.O spouse and DET.father GEN.O DET-1SG.GEN.O spouse
 ‘I will give my youngest child to live at my father’s house to replace me, and I will go with
 my wife and my wife’s father.’
- (203) Gai ia ga hidi age i de masavaa laa, ga saabai mai Dehuemalaedoli
 then 3SG PRSP stand.up up PREP DET time DIST PRSP carry DIR.PROX Dehuemalaedoli
 ‘So he got up then and carried Dehuemalaedoli’
- (204) ga dugu ange gi hongā luu vae o d-ono damana go Vave.
 PRSP put DIR.DIST to top DET.DU leg GEN.O DET-3SG.GEN.O father COP.FOC Vave
 ‘and he put him on his father Vave’s lap.’
- (205) Gai ia ga basa ange ga hai ange,
 then 3SG PRSP talk DIR.DIST PRSP say DIR.DIST
 ‘Then he talked to him and said,’
- (206) De-nei d-au dama aau e maanadu ai au i oo daha,
 DET-PROX DET-2SG.GEN.A child 2SG.GEN.A IPFV think OBL 1SG PREP 2SG.GEN.O place
 gai au ga hano nei loo ma d-ogu bodu ma tamana o
 then 1SG PRSP go.SG PROX EMPH and DET-1SG.GEN.O spouse and DET.father GEN.O
 d-ogu bodu
 DET-1SG.GEN.O spouse
 ‘This is your child for you to remember me by, and I’m leaving with my wife and my
 wife’s father’
- (207) be go hee be go hee omaadeu e hulo gi agina.
 COMP.INT COP.FOC where COMP.INT COP.FOC where 1PL.EXCL IPFV go.PL to there
 ‘wherever we may go.’
- (208) Gai a Vave ga paa huu lu-oono lima i de masavaa laa, ga see,
 then PN Vave PRSP clap when DET.DU-3SG.GEN.O hand PREP DET time DIST PRSP cry.out
 ga dangi.
 PRSP cry
 ‘And Vave clapped his hands at that time and cried out and wept.’

- (209) Gu manadua age ia, ana hegau baubau ne hai ange laa gi tamana o
 INC think up 3SG 3SG.GEN.A work bad PFV do DIR.DIST DIST to DET.father GEN.O
 de bodu o d-ana dama
 DET spouse GEN.O DET-3SG.GEN.A child
 ‘He recalled the horrible things he had done to the father-in-law of his son,’
- (210) go Iaidemalo laa.
 COP.FOC Iaidemalo DIST
 ‘Iaidemalo.’
- (211) Gai gu dee iloo ange ia be dehee d-ana hai e hai ai,
 then INC DET know DIR.DIST 3SG COMP.INT which DET-3SG.GEN.A way IPFV do OBL
 Iaidemalo gu duu age d-ono lodo bolo ia ga hano ma d-ono
 Iaidemalo INC stand up DET-3SG.GEN.O want COMP 3SG PRSP go.SG and DET-3SG.GEN.O
 bodu ma tamana o d-ono bodu.
 wife and DET.father GEN.O DET-3SG.GEN.O spouse
 ‘He didn’t know what to do, Iaidemalo had stood fast on his decision to leave with his
 wife and his wife’s father.’
- (212) Gai ia ga dugu d-ana damaa gauligi go Dehuemalaedoli i daho
 then 3SG PRSP put DET-3SG.GEN.A child young COP.FOC Dehuemalaedoli PREP place.of
 lu-oono maadua, gai ia ga kave lu-oono daina haahine, go
 DET.DU-3SG.GEN.O parents then 3SG PRSP take DET.DU-3SG.GEN.O sibling female COP.FOC
 Gauna ma Hagalolo.
 Gauna and Hagalolo
 ‘And he left his child Dehuemalaedoli with his parents, and he took his two sisters Gauna
 and Hagalolo.’
- (213) Ga hulo ai gilaadeu, ma gau o d-ono bodu i de-laadeu moni.
 PRSP go.PL OBL 3PL and people GEN.O DET-3SG.GEN.O spouse PREP DET-3PL.GEN canoe
 Ga hulo ai.
 PRSP go.PL OBL
 ‘And they left, with his wife’s family on their canoe. They left.’

- (214) Gilaadeu ga solo iho de-laadeu moni gi dai i hongade gelegele, ga
 3PL PRSP grate down DET-3PL.GEN canoe to lagoon PREP top DET beach PRSP
 dae iho gi lausedi, gilaadeu ga kage gi ono elunga.
 reach down to salt.water 3PL PRSP take to 3SG high.position
 ‘They dragged their canoe to the lagoon on the beach and reached the water and they
 climbed on board.’
- (215) Gilaadeu ga dogo mai laa dai, de henua gi ngaage,
 3PL PRSP pole DIR.PROX DIST lagoon DET island to south
 ‘They poled in the lagoon toward the south end of the island.’
- (216) e hulo gi de momme o de ava iai. E ssao ai gi dua.
 IPFV go.PL to DET place GEN.O DET channel exist IPFV go.out OBL to back
 ‘and they went to the place where the channel is, and they went out to the sea.’
- (217) Gilaadeu ga loo-adu huu, ga daea adu de momme o de ava
 3PL PRSP go-DIR.MED when PRSP reach.CIA DIR.MED DET place GEN.O DET channel
 iai, ga hhagi age gi dua i lote ava, gai ia gu manadua age hogi
 exist PRSP sharp.turn up to back PREP inside.DET channel then 3SG INC think up also
 i de masavaa laa bolo, ia gu aloha i d-ana damaa gauligi ne dugu
 PREP DET time DIST COMP 3SG INC love PREP DET-3SG.GEN.A child young PFV put
 ange laa gi daho d-ono damana.
 DIR.DIST DIST to place.of DET-3SG.GEN.O father
 ‘As they continued and reached the place where the channel is, and they turned toward
 the ocean inside the channel, he remembered then that he loved his child that he had left
 with his father.’
- (218) Gai ga tae age huu gilaadeu gi lote haiava i dai Senugudai
 then PRSP reach.PL up when 3PL to inside.DET path PREP lagoon Senugudai
 ‘So when they reached the road on the lagoon-side of Senugudai.’
- (219) gai ia ga hai ange gi lu-oono daina haahine
 then 3SG PRSP say DIR.DIST to DET.DU-3SG.GEN.O sibling female
 ‘he said to his two sisters.’
- (220) D-agu maanadu e dee ni dago loo e hulo gooluu.
 DET-1SG.GEN.A think IPFV NEG COP.PL rituals EMPH IPFV go.PL 2du
 ‘I think it’s not necessary for you two to go.’

- (221) Gooluu too ma gi aahe age laa uda.
 2DU fall.PL and SBJV return.PL up DIST inland
 ‘You two, get off and return back up on land.’
- (222) Diiloo ange ai taadeu dama. D-agu maanadu Dehuemalaedoli
 look.after.CIA DIR.DIST OBL DET.1PL.INCL child DET-1SG.GEN.A think Dehuemalaedoli
 e dangidangi naa aboo
 IPFV cry.RED MED tonight
 ‘Look after our child. I think Dehuemalaedoli will be crying tonight’
- (223) hidinga ia e buliaamou naa donu i gimaau ma Leibua.
 because 1SG IPFV long.for MED truly PREP 1DU.EXCL and Leibua
 ‘because he will miss me and Leibua.’
- (224) Gai lu-oono daina ga hai gi bei ana muna ne hai ange gi gilaau.
 then DET.DU-3SG.GEN.O sibling PRSP do to like 3SG.GEN.A word PFV say DIR.DIST to 3DU
 ‘So his two sisters did as he told them.’
- (225) Gilaau ga too ga loomai gai Iaidemalo gu hano ma d-ono
 3DU PRSP fall.PL PRSP go.PL-DIR.PROX then Iaidemalo INC go.PL and DET-3SG.GEN.O
 bodu ma tamana o d-ono bodu.
 spouse and DET.father GEN.O DET-3SG.GEN.O spouse
 ‘They got off and came back and Iaidemalo left with his wife and his wife’s father.’
- (226) Ga ssula huu gilaadeu gi dua, i mate ava o de henua nei,
 PRSP appear.PL when 3PL to back PREP front.DET channel GEN.O DET island PROX
 gilaadeu ga haga-duu age de-laadeu laa gi lunga
 3PL PRSP CAUS-stand up DET-3PL.GEN sail to up
 ‘And when they arrived on the ocean-side in front of the island’s channel, they hoisted
 their sail up’
- (227) ga dele ai. Gilaadeu ga dele ga hulo.
 PRSP sail OBL 3PL PRSP sail PRSP go.PL
 ‘and they sailed. They sailed away.’
- (228) Ga hulo hulo huu gilaadeu, gu tau i dahi henua, de ingoo o de
 PRSP go.PL go.PL when 3PL INC land.at.PL PREP one island DET name GEN.O DET
 henua laa, e hai ange bolo go Hidi.
 island DIST IPFV say DIR.DIST COMP COP.FOC Tahiti
 ‘and they went and went and landed at an island, the name of that island was Tahiti.’

- (229) Gai de gau i Hidi ga daa tamana o d-ono bodu, ma
 then DET people PREP Tahiti PRSP kill DET.father GEN.O DET-3SG.GEN.O spouse and
 d-ono bodu donu, ma ia, ma gau ange, ne hulo ma gilaadeu i
 DET-3SG.GEN.O spouse truly and 3SG and people DIR.DIST PFV go.PL and 3PL PREP
 de-laadeu moni.
 DET-3PL.GEN canoe
 ‘And the people of Tahiti killed his wife’s father and his wife and him and the people that
 had come with them in their canoe.’
- (230) Ga odi i de maakau.
 PRSP empty PREP DET die.PL
 ‘They killed all of them’
- (231) Gai de gau laa ga haga-duu e haa laagau gi lunga ga hili
 then DET people DIST PRSP CAUS-stand IPFV four branch to above PRSP arrange.platform
 ono elunga ga dugu ange Leibua ma Logo ma gau ange i
 3SG.GEN.O high.position PRSP put DIR.DIST Leibua and Logo and people DIR.DIST PREP
 de-laadeu moni ma dali gilaau gai ga dahu age de ahi i lalo ga
 DET-3PL.GEN canoe with 3DU then PRSP build.fire up DET bonfire PREP below PRSP
 diidii ai.
 shine.RED OBL
 ‘And those people erected four posts and created a platform on top and put Leibua and
 Logo and the people that came with them in their canoe and they started a fire below and
 it burned.’
- (232) Gai ia go Iaidemalo ne haga-duu dahi laagau gi lunga ga hai bei tagodo
 then 3SG COP.FOC Iaidemalo PFV CAUS-stand one branch to above PRSP do like DET.state
 o de bou ga gaau ange denga daula gi de ulu de laagau ga nnoa
 GEN.O DET mast PRSP fasten DIR.DIST DET.PL rope to DET top DET branch PRSP tie
 ange gi agina ga dada gi lunga ga lava ga hagasege iho gi lalo.
 DIR.DIST to there PRSP pull to above PRSP finish PRSP CAUS-slide down to below
 ‘And as for Iaidemalo, they erected a post like the mast of a canoe and fastened lines to the
 top of the post and tied him to it and they pulled him up and then they lowered him down.’
- (233) Gai ga dabudabui de baba
 then PRSP splash.water.RED DET flat.surface
 ‘Then they splashed water on the platform’

- (234) gai de baba laa ga ula bei de ahi haula.
 then DET flat.surface DIST PRSP aflame like DET fire set.fire
 ‘and the platform burned like a bonfire.’
- (235) Gai gilaadeu ga dugu iho gi lote ula o de ahi laa
 then 3PL PRSP put down to inside.DET aflame GEN.O DET fire DIST
 ‘Then they put him down into the flames of the fire’
- (236) ga lava ga dada gi lunga
 PRSP finish PRSP pull to above
 ‘and then they pulled him up’
- (237) gai ga hagasege iho gi lalo gai ga dabudabui de baba
 so PRSP CAUS-slide down to below then PRSP splash.water.RED DET flat.surface
 ‘and they lowered him down below and splashed water on the platform’
- (238) gai de baba ga ula bei de ahi haula
 so DET flat.surface PRSP aflame like DET fire set.fire
 ‘and the platform burned like a bonfire’
- (239) gai gilaadeu ga hagasege iho gi lote ula o de ahi
 PRSP 3PL PRSP CAUS-slide down to inside.DET aflame gen DET fire
 ‘and they lowered him into the flames of the fire.’
- (240) De-laa ai de haga-duasala a de gau i de henua go Hidi
 DET-DIST OBL DET CAUS-hardship GEN.A DET people PREP DET island COP.FOC Tahiti
 ne vange gi Iaidemalo ma d-ono bodu ma tamana o d-ono
 PFV give to Iaidemalo and DET-3SG.GEN.O spouse and DET.father GEN.O DET-3SG.GEN.O
 bodu ma gau ne hulo ma gilaadeu gi de henua laa.
 spouse and people PFV go.PL and 3PL to DET island DIST
 ‘So that’s the punishment that the people of the island of Tahiti gave to Iaidemalo and his
 wife and his wife’s father and the people that went with them to that island.’
- (241) Gai dahi laangi huu gai dahi balia ange hogi d-ono ingoo go
 then one day when then one navigator DIR.DIST also DET-3SG.GEN.O name COP.FOC
 Tubuanage.
 Tubuanage
 ‘So one day, there was another navigator, whose name was Tubuanage.’

- (242) Gai ia ga humai hogi ga hagadaahao mai i de moana i
 then 3SG PRSP come.SG also PRSP play DIR.PROX PREP DET open.ocean PREP
 d-ono henua ne humai ai laa
 DET-3SG.GEN.O island PFV come.SG OBL DIST
 ‘And he came also and was sightseeing on the ocean from the island that he came from’
- (243) ga dae mai ai hogi gi Hidi ga gidee ai e ia tagodo o de gau
 PRSP reach DIR.PROX OBL also to Tahiti PRSP see OBL ERG 3SG DET.state gen DET people
 ne maakau laa i de daa a de gau i Hidi gai ia ga damaa noho
 PFV die.PL DIST PREP DET kill gen DET people PREP Tahiti then 3SG PRSP little live
 ange i Hidi ga lava ga maanadu age bolo ia ga hano gee ange
 DIR.DIST PREP Tahiti PRSP finish PRSP think up COMP 3SG PRSP go.SG away DIR.DIST
 hogi i de henua laa
 also PREP DET island DIST
 ‘and he came also to Tahiti and he saw how those people died, killed by the people of
 Tahiti, so he stayed on Tahiti for a little while, but he decided to leave that island’
- (244) e tilo be dahi angeana henua e gide hoou ange.
 IPFV look.at if one other 3SG.GEN.A island IPFV find new DIR.DIST
 ‘to see if there was another island that he could discover.’
- (245) Gai ia ga hano gee ai loo i Hidi, ia go Tubuanage.
 then 3SG PRSP go.SG away OBL EMPH PREP Tahiti 3SG COP.FOC Tubuanage
 ‘So he departed from Tahiti, Tubuanage did.’
- (246) Gai ia ga hagadaga mai i ono henua ne humai ai laa
 then 3SG PRSP go.place.to.place DIR.PROX PREP 3SG.GEN.O island PFV come.SG OBL DIST
 i d-ono hano gee i Hidi
 PREP DET-3SG.GEN.O go.SG away PREP Tahiti
 ‘Then he sailed to several islands that he went to, after he left Tahiti’
- (247) ga humai humai humai huu gu dae mai hogi gi de henua nei.
 PRSP come.SG come.SG come.SG when INC reach DIR.PROX also to DET island PROX
 ‘and he came and came and came and also reached this island (Nukuoro).’
- (248) Dae mai huu gu he-gide ange ia gi a Vave ma ono dangada e
 reach DIR.PROX when INC RCPR-see DIR.DIST 3SG to PN Vave and 3SG.GEN.O person IPFV
 nnoho laa gilaadeu i de henua nei
 live.PL DIST 3PL PREP DET island PROX
 ‘When he arrived, he met Vave and his people that lived on this island’

- (249) gai gilaadeu ga nnoho ai loo.
 then 3PL PRSP live.PL OBL EMPH
 ‘and they lived here.’
- (250) Gilaadeu ga nnoho hagabuni i de henua nei.
 3PL PRSP live.PL gather.together PREP DET island PROX
 ‘They lived together on this island.’
- (251) Tubuanage e noho i d-ono momme e noho ai laa gai ia e
 Tubuanage IPFV live PREP DET-3SG.GEN.O place IPFV live OBL DIST then 3SG IPFV
 seese mai i hanu laangi gi daho Vave ma e madaangudu ai gilaau.
 walk DIR.PROX PREP some day to place.of Vave and IPFV talk.to OBL 3DU
 ‘Tubuanage stayed at the place where he lived, and he would walk some days to where
 Vave was and they would talk to each other.’
- (252) Gai ia e madaangudu ange gi a Vave gai ia e daumada a Vave
 then 3SG IPFV talk.to DIR.DIST to PN Vave then 3SG IPFV observe.closely PN Vave
 ‘He would talk with Vave and he would observe Vave’
- (253) hidinga d-ana gidee ange bolo de-laa tee madea ma taane daa
 because DET-3SG.GEN.A see DIR.DIST COMP DET-DIST PFV.NEG identify and DET.man tattoo
 hagasaalei e huna i de malo sabo
 striped IPFV clothed PREP DET loincloth
 ‘because to his eyes, Vave looked no different from the tattooed man dressed in a loincloth’
- (254) e laalaangia laa i de gula i Hidi.
 IPFV roast.CIA DIST PREP DET large.fire PREP Tahiti
 ‘who was burning in the fire on Tahiti.’
- (255) Gai a Vave gu gidee ange e ia hegau a Tubuanage e hai ange gi
 then PN Vave INC see DIR.DIST ERG 3SG work GEN.A Tubuanage IPFV do DIR.DIST to
 de ia i laangi alodahi e humai ai gi ono daha
 DET 3SG PREP day all IPFV come OBL to 3SG.GEN.O place
 ‘And Vave saw what Tubuanage was doing to him every day, coming to see him’
- (256) i de daumada huu ia.
 PREP DET observe when 3SG
 ‘and observing him.’

- (257) Gai dahi laangi huu gai ia ga ssili ange gi Tubuanage,
 then one day when then 3SG PRSP ask DIR.DIST to Tubuanage
 ‘So one day, he asked Tubuanage,’
- (258) Go de aha aau gu daumada ai naa huu au i laangi alodahi
 COP.FOC DET what 2SG.GEN.A INC observe OBL MED when 1SG PREP day all
 oou e dae mai ai gi ogu daha i kinei?
 2SG.GEN.O IPFV reach DIR.PROX OBL to 1SG.GEN.O place PREP here
 ‘Why do you keep staring at me every day when you come to see me here?’
- (259) Gai Tubuanage ga hai ange gi a Vave,
 then Tubuanage PRSP say DIR.DIST to PN Vave
 ‘So Tubuanage said to Vave,’
- (260) Hidinga au e dahi agu daane e gide e laalaangia i de gula i
 because 1SG IPFV one 1SG.GEN.A man IPFV see IPFV roast.CIA PREP DET fire PREP
 Hidi e dee dulagi gee donu ma d-oo dagodo naa.
 Tahiti IPFV NEG seem different truly and DET-2SG.GEN.O lay MED
 ‘Because I saw a man roasted in a fire on Tahiti and his appearance wasn’t that different
 from yours.’
- (261) E huna i de malo sabo e daa hagasaalei de hadahada gai de-laa
 IPFV hide PREP DET loincloth IPFV tattoo striped DET chest then DET-DIST
 d-ono hai e haia ai e de gau i Hidi
 DET-3SG.GEN.O way IPFV do.CIA OBL ERG DET people PREP Tahiti
 ‘He was wearing a loincloth and he had striped tattoos on his chest, and that was what
 was done to him by the people of Tahiti,’
- (262) agu e tala adu nei gi de goe.
 1SG.GEN.A PRSP tell DIR.MED PROX to DET 2sg
 ‘what I told you just now.’
- (263) Gai a Vave gu dangi i de masavaa laa
 then PN Vave INC cry PREP DET moment DIST
 ‘And Vave cried then’

- (264) gu manadua age e ia de hinangalosaa i d-ana dama, de aloha ma
 INC remember up ERG 3SG DET longing PREP DET-3SG.GEN.A child DET love and
 de buliaamou.
 DET long.for
 ‘and he remembered how he missed his son with love and longing.’
- (265) Gai taiao age laa huu gai a Vave ga maanadu age bolo e danuaa
 then DET.tomorrow up DIST when then PN Vave PRSP think up COMP IPFV good
 loo hoga demaadeu hagamolau
 EMPH also DET-1PL.EXCL exile
 ‘So the next morning, Vave decided, It would be best for us to also leave the island.’
- (266) e hulo gee i de henua nei e hano ai au e tilo be au e
 IPFV go.PL away PREP DET island PROX IPFV go.SG OBL 1SG IPFV look.at COMP.INT 1SG IPFV
 heda e ange laa gi d-agu dama ne hano laa hidinga go au donu
 meet DIR.DIST DIST to DET-1SG.GEN.A child PFV go.SG DIST reason COP.FOC 1SG truly
 ne hidi ai laa d-ono hano
 PFV cause OBL DIST DET-3SG.GEN.O go.SG
 ‘to sail away from this island so I can go and see if I can find my child, who left because
 of me’
- (267) ga magau i de henua a Tubuanage ne gide ai laa ia.
 PRSP die.SG PREP DET island PN Tubuanage PFV see OBL DIST 3SG
 ‘and died on the island where Tubuanage saw him.’
- (268) Gai gilaadeu ga doo-ange olaadeu mee i taiao age ma ono
 then 3PL PRSP fall-DIR.DIST 3PL.GEN.O thing PREP DET.morning up and 3SG.GEN.O
 gau,
 people
 ‘So they packed their things the next morning, him and his people’
- (269) lu-aana damaa hine donu ma d-ana dama daane go Deagu
 DET.DU-3SG.GEN.A child female truly and DET-3SG.GEN.A child male COP.FOC Deagu
 ma d-ono bodu go Gausugilogo,
 and DET-3SG.GEN.O spouse COP.FOC Gausugilogo
 ‘his two daughters and his son Deagu and his wife Gausugilogo.’

- (270) ga dada mai de oo i lote husi gilaadeu ga maalanga ga
 PRSP pull DIR.PROX DET ration PREP inside.DET taro.patch 3PL PRSP depart PRSP
 hulo gee hogi i de henua nei.
 go.PL away also PREP DET island PROX
 ‘and after they picked taro for the journey, they set sail and also left this island.’
- (271) Alodahi donu denga mogobuna o d-ana dama ... alodahi donu ono
 all truly DET.PL grandchild GEN.O DET-3SG.GEN.A child all truly 3SG.GEN
 mogobuna go Vave i dama daane dogo-dolu a d-ana dama
 grandchild COP.FOC Vave PREP child male CL.HUM-three GEN.A DET-3SG.GEN.A child
 go Iaidemalo, ne kave ga hulo ai gilaadeu
 COP.FOC Iaidemalo PFV take PRSP go.PL OBL 3PL
 ‘All the grandchildren of his son... all of Vave’s grandchildren, the three sons of his son
 Iaidemalo, he took them with him when they left.’
- (272) ma gau e nnoho laa alodahi i ono daha i de masavaa laa.
 and people IPFV live.PL DIST all PREP 3SG.GEN.O place PREP DET time DIST
 ‘and all the people who lived with him at that time.’
- (273) Ga hulo huu gilaadeu ga ssao gi dua i de ava o de henua nei,
 PRSP go.PL when 3PL PRSP go.out to back PREP DET channel GEN.O DET island PROX
 gai ia ga hai ange gi lu-aana damaa hine go Hagalolo ma Gauna,
 then 3SG PRSP say to DET.DU-3SG.GEN.A child female COP.FOC Hagalolo and Gauna
 ‘As they left and went out to sea through the island’s channel, he said to his two daughters
 Hagalolo and Gauna,’
- (274) Gooluu hai ange gi d-ooluu bodu, ia gi gaavee gidaadeu gi de madaa
 2DU say DIR.DIST to DET-2DU.GEN spouse 3SG SBJV give.CIA 1PL.INCL to DET front
 moni e hulo ai laa ga tau i Hidi
 canoe IPFV go.PL OBL DIST PRSP arrive.PL PREP Tahiti
 ‘You two, tell your husband, he should take us in the direction that will go and arrive at
 Tahiti’
- (275) e tilo ai be heda e ange au gi d-agu dama daane go
 IPFV look.at OBL COMP.INT meet DIR.DIST 1SG to DET-1SG.GEN.A child male COP.FOC
 Iaidemalo.
 Iaidemalo
 ‘to see if I can reunite with my son Iaidemalo.’

- (276) Gai lu-aana damaa hine ga tala ange ana muna gi de-laau
 then DET.DU-3SG.GEN.A child female PRSP tell DIR.DIST 3SG.GEN.A word to DET-3DU.GEN
 bodu go Gaeuli.
 spouse COP.FOC Gaeuli
 'So his two daughters told his instructions to their husband Gaeuli.'
- (277) Gaeuli ga kave de-laadeu madaa moni ga hulo ai
 Gaeuli PRSP take DET-3PL.GEN front canoe PRSP go.PL OBL
 'Gaeuli steered their canoe in that direction as they sailed'
- (278) bolo e hulo gi Hidi.
 COMP PRSP go.PL to Tahiti
 'so that they would go to Tahiti.'
- (279) Gai gilaadeu ga dele i de moana, hulo ai, hulo saele ai
 then 3PL PRSP sail PREP DET open.ocean go.PL OBL go.PL around OBL
 'So they sailed on the open sea, and sailed, and sailed all around'
- (280) hulo hulo hulo hulo hulo, dee dau henua dee dau e dee maua gi tau
 go.PL go.PL go.PL go.PL go.PL NEG arrive island NEG arrive IPFV NEG be.able SBJV arrive.PL
 i Hidi.
 PREP Tahiti
 'and they sailed and sailed and sailed, but they didn't reach any islands, they couldn't
 reach Tahiti.'
- (281) Tigi gidee e gilaadeu de henua go Hidi.
 not.yet see ERG 3PL DET island COP.FOC Tahiti
 'They still hadn't found the island of Tahiti.'
- (282) Dahi laangi huu gai gilaadeu gu gidee dahi henua, gu hedae ange gi dahi henua.
 one day when then 3PL INC see one island INC meet DIR.DIST to one island
 'Then one day, they found an island, they came to an island.'
- (283) Gai gilaadeu ga loo-age gi de henua laa
 then 3PL PRSP go.PL-up to DET island DIST
 'So they sailed up to that island'

- (284) ga loo-age huu gilaadeu ga tau i de henua laa, d-agu bau
 PRSP go.PL-up when 3PL PRSP arrive.PL PREP DET island DIST DET-1SG.GEN.A determine
 e dee de-laa loo de henua go Hidi olaadeu ne hulo laa gi agina.
 IPFV NEG DET-DIST EMPH DET island COP.FOC Tahiti 3PL.GEN.O PFV go.PL DIST to there
 ‘And when they went up and arrived at that island, they had not arrived on the island of
 Tahiti.’
- (285) Gilaadeu ne tau i de henua go Oneabu.
 3PL PFV arrive.PL PREP DET island COP.FOC Oneop
 ‘They had arrived at the island of Oneop (in the Mortlock Islands).’
- (286) Gilaadeu ga tau i Oneabu ga damaa nnoho ange ai i e hia
 3PL PRSP arrive.PL PREP Oneop PRSP little live.PL DIR.DIST OBL PREP IPFV how.many
 laangi ma e hia boo
 day and IPFV how.many night
 ‘They arrived at Oneop and they briefly stayed there for a few days and a few nights’
- (287) ga nnoho nnoho ai huu gilaadeu, gai ia gu manadua age bolo gilaadeu ga
 PRSP live.PL live.PL OBL when 3PL then 3SG INC think up COMP 3PL PRSP
 hulo gee hogi i de henua laa.
 go.PL away also PREP DET island DIST
 ‘and as they stayed there, he decided they should leave that island as well.’
- (288) Gai gilaadeu ga doo ange olaadeu mee ga malanga, ga hulo gee hogi
 then 3PL PRSP drop DIR.DIST 3PL.GEN.O thing PRSP depart PRSP go.PL away also
 i de henua laa
 PREP DET island DIST
 ‘So they packed their things and departed, and left that island also.’
- (289) Gai de-laadeu laangi huu ne malanga ai e hulo gee i Oneabu ga
 then DET-3PL.GEN day when PFV depart OBL IPFV go.PL away PREP Oneop PRSP
 loo-iho gi de-laadeu moni e ssao e hulo gi de moana.
 go.PL-down to DET-3PL.GEN canoe IPFV go.out IPFV go.PL to DET open.ocean
 ‘So the day that they set sail and left Oneop, they went down to their canoe and went out
 and went to the open sea.’

- (290) Gai e dahi daane madumadua e gaugau i lausedi i de laangi laa ma
 then IPFV one man old.RED IPFV bathe PREP salt.water PREP DET day DIST and
 e hhuge ai ana duu gaha ma de tao.
 IPFV uncover OBL 3SG.GEN.A coconut.husk and DET soak.water
 ‘And there was an old man bathing in the sea that day who was uncovering his coconut
 husks that were soaking in the water.’
- (291) Gai ga loo-iho huu de gau laa e malanga e hulo, gai ia ga
 then PRSP go.PL-down when DET people DIST IPFV depart IPFV go.PL then 3SG PRSP
 helau dahi labodo, gaav-ange gi lote ama de moni o de
 sorcery one eel give-DIR.DIST to inside.DET outrigger.float DET canoe GEN.O DET
 gau laa.
 people DIST
 ‘So when the people went down and set sail and left, he conjured an eel to go and stay
 inside the outrigger float of their canoe.’
- (292) Gai ga ssao huu gilaadeu ga hulo gi dua i de-laadeu malanga i de
 then PRSP go.out when 3PL PRSP go.PL to back PREP DET-3PL.GEN depart PREP DET
 henua go Oneabu,
 island COP.FOC Oneop
 ‘So when they went out to the sea during their departure from the island of Oneop’
- (293) gai de labodo laa e noho i lote ama de-laadeu moni.
 then DET eel DIST IPFV live PREP inside.DET outrigger.float DET-3PL.GEN canoe
 ‘the eel stayed inside the outrigger float of their canoe.’
- (294) Gai ia ga hano ga ... ga ngalungalue saele ga daagai saele i lote
 then 3SG PRSP go.SG PRSP PRSP move.red around PRSP flounder around PREP inside.DET
 ama de bido de biho e sula gi mua de bido i ssugi e sula
 outrigger.float DET end DET head IPFV appear to front DET end PREP DET.tail IPFV appear
 gi muli i luu bite ama.
 to behind PREP DET.DU end.DET outrigger.float
 ‘And it went and moved around and floundered around inside the outrigger float, its head
 side was sticking out in the front of the float and the tail side was sticking out the back,
 on the two sides of the float.’

- (295) Se hai donu taane madumadua laa ne hai bolo e hai gi dee dau henua
 COP.SG do truly DET.man old.RED DIST PFV do COMP IPFV do SBJV NEG arrive island
 ai de gau laa i Hidi
 OBL DET people DIST PREP Tahiti
 ‘The old man’s plan was to keep them from reaching Tahiti’
- (296) gi dee he-gide ange ai a Vave gi d-ana dama go Iaidemalo.
 SBJV NEG RCPR-see DIR.DIST OBL PN Vave to DET-3SG.GEN.A child COP.FOC Iaidemalo
 ‘so Vave would never reunite with his son Iaidemalo.’
- (297) Gilaadeu ga hulo saele ai huu i de moana
 3PL PRSP go.PL around OBL when PREP DET open.ocean
 ‘They sailed around on the open sea’
- (298) hulo hulo hulo hulo hulo hulo dee maua gi gidee dahi henua,
 go.PL go.PL go.PL go.PL go.PL NEG be.able SBJV see one island
 ‘and they went and went and went but they weren’t able to find any islands,’
- (299) gai gu dahi odi gai i de-laadeu moni.
 then INC one empty food PREP DET-3PL.GEN canoe
 ‘and they were almost out of food on their canoe.’
- (300) Gai a Vave ga hai ange gi lu-aana damaa hine,
 then PN Vave PRSP say DIR.DIST to DET.DU-3SG.GEN.A child female
 ‘So Vave said to his two daughters’
- (301) Gooluu siilia ange muuhuu gi d-ooluu bodu be dehee tagodo
 2DU ask.CIA DIR.DIST please to DET-2DU.GEN spouse COMP.INT which DET.state
 odaadeu gu dee maua ai nei gi dau henua
 1PL.INCL.GEN.O INC NEG be.able OBL PROX SBJV arrive island
 ‘You two, go ask your husband why we can’t seem to land on any islands’
- (302) gai ga odi nei gai i taadeu moni.
 then PRSP empty PROX food PREP DET.1PL.INCL.GEN canoe
 ‘and are running out of food on our canoe.’

- (303) Gai Gaeuli gu gidee e ia tagodo nei i mua olaadeu e dee dau henua
 then Gaeuli INC see ERG 3SG DET.state PROX PREP front 3PL.GEN.O IPFV NEG arrive island
 ai laa.
 OBL DIST
 ‘But Gaeuli had foreseen why they couldn’t reach any islands.’
- (304) De mee a Gaeuli ne gide i lotana buubuu bolo ga odi
 DET thing GEN.A Gaeuli PFV see PREP inside.DET.3SG.GEN.A divination COMP PRSP empty
 naa gilaadeu i tee maaleva i de moni gai go Vave sogosogo
 MED 3PL PREP PFV.NEG present.PL PREP DET canoe then COP.FOC Vave alone
 donu huu, gai ga dau henua.
 only then PRSP reach island
 ‘What Gaeuli saw in his divination was that if everyone died, and there was no one on
 the canoe except Vave, he could make landfall.’
- (305) Aagai ga dee maleva naa a Vave i de moni go gilaadeu donu huu e
 then PRSP NEG present MED PN Vave PREP DET canoe COP.FOC 3PL only IPFV
 nnoho i de moni gai gilaadeu ga maua gi dau henua.
 live.PL PREP DET canoe then 3PL PRSP be.able SBJV arrive island
 ‘or if Vave was no longer with them on the canoe, if it was only them in the canoe, then
 they would be able to make landfall.’
- (306) Gai Gaeuli gu hai mee gaiaa i a Vave i de tala ange tagodo nei gi
 then Gaeuli INC do thing steal PREP PN Vave PREP DET tell DIR.DIST DET.state PROX to
 lu-oono bodu,
 DET.DU-3SG.GEN.O spouse
 ‘But Gaeuli was uncomfortable to share this with Vave by telling his wives,’
- (307) go luu damaa hine a Vave.
 COP.FOC DET.DU child female GEN.A Vave
 ‘Vave’s two daughters.’
- (308) Gai ia ga noho hagalongolongo ngadaa.
 then 3SG PRSP live carefully with.difficulty
 ‘So he was hesitant to share.’
- (309) Aagai a Vave ga haga-ahe ange hogi i de lua hanonga ga ssili ange
 then PN Vave PRSP CAUS-return DIR.DIST also PREP DET two time PRSP ask DIR.DIST
 ‘And Vave came back and asked for a second time’

- (310) ga hai ange gi lu-aana damaa hine,
 PRSP say DIR.DIST to DET.DU-3SG.GEN.A child female
 ‘and said to his two daughters,’
- (311) Gooluu siilia ange muuhuu gi d-ooluu bodu be aahee hidinga
 2DU ask.CIA DIR.DIST please to DET-2DU.GEN spouse COMP.INT which reason
 odaadeu e dee dau henua ai nei.
 1PL.INCL.GEN.O IPFV NEG arrive island OBL PROX
 ‘You two, please ask your husband why we haven’t made landfall yet.’
- (312) Gai de lua hanonga huu gai Gaeuli ga tala ange de mee aana ne gide
 then DET two time when then Gaeuli PRSP tell DIR.DIST DET thing 3SG.GEN.A PFV see
 i lotana buubuu gi luu damaa hine a Vave.
 PREP inside.DET-3SG.GEN.A divination to DET.DU child female GEN.A Vave
 ‘So the second time, Gaeuli recounted what he saw in his divination to Vave’s daughters.’
- (313) Gai lu-aana damaa hine ga tala ange gi de ia go Vave
 then DET.DU-3SG.GEN.A child female PRSP tell DIR.DIST to DET 3SG COP.FOC Vave
 ‘And his two daughters told him, Vave’
- (314) ga hai ange,
 PRSP say DIR.DIST
 ‘and said,’
- (315) Bolo i Gaeuli ga dee maaleva naa gimaadeu ma dali goe i de moni, go
 say PREP Gaeuli PRSP NEG present.PL MED 1PL.EXCL with 2sg PREP DET canoe COP.FOC
 koe sogosogo donu huu gai ga maua gi dau henua
 you alone only then PRSP be.able to arrive island
 ‘According to Gaeuli, if we weren’t with you on the canoe, and it was only you alone, you
 would be able to find land’
- (316) gai ga dee maleva naa goe i de moni gai go gimaadeu donu huu e
 then PRSP NEG present MED 2sg PREP DET canoe then COP.FOC 1PL.EXCL only IPFV
 nnoho gai gimaadeu ga dau henua.
 live.PL then 1PL.EXCL PRSP arrive island
 ‘or if you weren’t here on the canoe, and only the rest of us stayed, we would be able to
 make landfall.’

- (317) Gai a Vave ga maanadu age i ono lodo i de masavaa laa,
 then PN Vave PRSP think up PREP 3SG.GEN.O inside PREP DET time DIST
 ‘And Vave thought to himself at that time’
- (318) ga hagamada age i d-ono ngudu,
 PRSP say up PREP DET-3SG.GEN.O mouth
 ‘and said from his mouth,’
- (319) Gai se aha, e hai go tangada sogosogo nei e dau henua, gai
 then COP.SG what IPFV do COP.FOC DET.person alone PROX IPFV arrive island then
 denga mouli soa nei ga maakau i ogu hidinga sogosogo nei donu huu?
 DET.PL live many PROX PRSP die.PL PREP 1SG.GEN.O reason alone PROX only
 ‘Why should I be the one to reach land alone, causing many living people to die, because
 of something I have done wrong?’
- (320) E danuaa de go ... go tangada sogosogo e dee maleva, gai mouli
 IPFV good DET COP.FOC COP.FOC DET.person alone IPFV NEG present then live
 soa ga dau henua.
 many PRSP arrive island
 ‘It is best for a single person to be gone, and the many living people to reach land.’
- (321) De-nei de maanadu ne han-age i lodo o Vave i de masavaa laa.
 DET-PROX DET think PFV come.SG-up PREP inside GEN.O Vave PREP DET time DIST
 ‘That’s the thought that came to Vave at that time.’
- (322) Gai ia ga haga-sula d-ono lodo han-age laa i de masavaa laa
 then 3SG PRSP CAUS-appear DET-3SG.GEN.O want come.SG-up DIST PREP DET time DIST
 ga basa ange ai gi ana dama
 PRSP talk DIR.DIST OBL to 3SG.GEN.A child
 ‘So he fulfilled his decision that he made at that time as he shared it with his children’
- (323) gai ia ga hai ange,
 then 3SG PRSP say DIR.DIST
 ‘and he said,’

- (324) Daiao naa huu gai au ga hano e dagodo i hongade ama
 tomorrow MED when then 1SG PRSP go.SG IPFV lay PREP top DET outrigger.float
 o taadeu moni i magavaa haadodo e lui ai madali de
 GEN.O DET.1PL.INCL.GEN canoe PREP between outrigger.peg IPFV turn OBL with DET
 ama.
 outrigger.float
 ‘Tomorrow, I will go and lay on top of the outrigger float of our canoe, between the sup-
 porting pegs, and turn myself so I’m in line with the float.’
- (325) Gai denga mamu naa huu e loomai ga gai-na saele d-ogu angaanga,
 then DET.PL fish IRR when IPFV come.PL PRSP eat-CIA around DET-1SG.GEN.O body
 ga dongidongi saele d-ogu gili, gai goodou, ga booboo ga gai mee
 PRSP peck.at around DET-1SG.GEN.O skin then 2PL PRSP catch.red PRSP eat thing
 ai goodoui taadeu masavaa e hulo saele ai nei i de
 OBL 2PL PREP DET.1PL.INCL.GEN time IPFV go.PL around OBL PROX PREP DET
 moana.
 open.ocean
 ‘So the fish who come and eat my body, and nibble at my flesh, you all will catch them so
 you can eat them while we are sailing along the open sea.’
- (326) Gai e dahi donu huu oodou mamu e dee gai i dengaa mamu e loomai
 then IPFV one only 2PL.GEN fish IPFV NEG eat PREP DET.PL.SUP fish IPFV come.PL
 laa gi d-ogu angaanga
 DIST to DET-1SG.GEN.O body
 ‘but there’s one fish that you can’t eat among the many fish that come to my body,’
- (327) go de gada moana
 COP.FOC DET fish.sp.jack
 ‘the *gada moana*,’
- (328) go hidinga go ia ne gai-na ogu daa-nga haga-mahamaha
 COP.FOC reason COP.FOC 3SG PFV eat-CIA 1SG.GEN.O tattoo-NMLZ CAUS-beautiful
 ‘because that fish has eaten my sacred tattoo’
- (329) e hagabinga laa bolo daa hagasalei i ogu hadahada.
 IPFV be.known DIST COMP tattoo striped PREP 1SG.GEN.O chest
 ‘which is what the tattoo on my chest is known as.’

- (330) De-laa ai gilaadeu ma ana dama hugadoo e eidu i de gada moana
 DET-DIST OBL 3PL and 3SG.GEN.A child above.all IPFV worship PREP DET fish.sp.jack
 ‘And so, he and his children worshipped the *gada moana* above all’
- (331) hidinga go ia ne gai-na, ono daa-nga hagasaaiei.
 because COP.FOC 3SG PFV eat-CIA 3SG.GEN.O tattoo-NMLZ striped
 ‘because that fish is the one who ate his tattoo.’
- (332) Gai ana dama ga hai gi bei ana muna ne tala ange gi gilaadeu.
 then 3SG.GEN.A child PRSP do to like 3SG.GEN.A word PFV tell DIR.DIST to 3PL
 ‘So his children did as he told them.’
- (333) Gilaadeu ga booboo mamu alodahi e loomai gi d-ono angaanga i
 3PL PRSP catch.red fish all IPFV come.PL to DET-3SG.GEN.O body PREP
 d-ono masavaa nogo dagodo ai laa i hongade ama, i
 DET-3SG.GEN.O time IPFV lay OBL DIST PREP top DET outrigger.float PREP
 magavaa haadodo, e dagodo donu i hongatai
 between outrigger.peg IPFV lay truly PREP top DET.sea
 ‘They grabbed all the fish that came to his body while he was laying on the outrigger
 between the two supporting pegs, laying on top of the water’
- (334) gai ana dama i hongade moni.
 then 3SG.GEN.A child PREP top DET canoe
 ‘while his children were on the canoe.’
- (335) E dolu boo olaadeu ne hai ai be laa i de moana.
 IPFV three night 3PL.GEN.O PFV do OBL like that PREP DET open.ocean
 ‘They did that for three nights on the ocean.’
- (336) Gai ga aho age huu taiao laa gai ia ga hai ange gi ana
 then PRSP dawn up when DET.morning DIST then 3SG PRSP say DIR.DIST to 3SG.GEN.A
 dama,
 child
 ‘So the next morning, he told his children,’

- (337) Ga boo iho naa huu de mee i de laangi ... ailaanei, ga oho age
 PRSP night down MED when DET thing PREP DET day today.FUT PRSP do.early up
 daiao, gai goodou ga tilo de momme o de laa e han-age ai laa.
 morning then 2DU PRSP look.at DET place GEN.O DET sun IPFV go.SG-up OBL DIST
 ‘When night falls today, and then the morning comes, look at the place where the sun
 comes up.’
- (338) Gai ga gidee adu naa huu e goodou dahi ada mee e han-age i
 then PRSP see DIR.MED MED when ERG 2PL one picture thing PRSP go.SG-up PREP
 lote soobo-nga o de laa gai goodou e iloo de-naa loo de mee
 inside.DET rise-NMLZ GEN.O DET sun then 2PL IPFV know DET-MED EMPH DET thing
 e humai e gaavee au
 IPFV come.SG IPFV send.CIA 1SG
 ‘When you look, an image will come up with the rising of the sun, and then you’ll know
 that is the thing that will come and take me away’
- (339) gai goodou ga dau henua ai.
 then 2PL PRSP arrive island OBL
 ‘and you’ll make landfall.’
- (340) Gai ga aho age huu taiao laa gu tanga age de laa gi lunga i
 then PRSP dawn up when DET.morning DIST INC loosen.PL up DET sun to above PREP
 hongai tai,
 over DET.sea
 ‘So when the morning came, and the sun separated from the horizon over the sea,’
- (341) gai ana dama gu gidee adu dahi ada mee e humai i lote
 then 3SG.GEN.A child INC see DIR.MED one image thing IPFV come.SG PREP inside.DET
 laa.
 sun
 ‘his children saw an image coming from inside the sun.’
- (342) De laa e hanage gi lunga gai de ada alaadeu e gide adu laa e
 DET sun IPFV come-up to above then DET image 3PL.GEN.A IPFV see DIR.MED DIST IPFV
 hagasoe mai donu huu gi gilaadeu
 go.directly DIR.PROX only to 3PL
 ‘The sun came up overhead, and the image that they saw came directly toward them’

- (343) e hagadaga huu de mao lunga o de laa aagai de mee laa e
 IPFV go.place.to.place when DET high GEN.O DET sun then DET thing DIST IPFV
 hagadaga de baa mai gi gilaadeu,
 go.place.to.place DET touch DIR.PROX to 3PL
 ‘and as the sun continued to rise higher, that thing (the image) came closer to them,’
- (344) ga humai humai huu gu dae mai gi gilaadeu
 PRSP come.SG come.SG when PRSP arrive DIR.DIST to 3PL
 ‘and came closer and closer until it reached them’
- (345) ga lui mai i ama ga noho mai ai i de momme
 PRSP turn DIR.PROX PREP outrigger.float PRSP live DIR.PROX OBL PREP DET place
 donu o Vave e dagodo ai laa i magavaa haadodo i hongga de
 truly GEN.O Vave IPFV lay OBL DIST PREP between outrigger.peg PREP top DET
 ama.
 outrigger.float
 ‘and faced along the float where Vave was laying between the supporting pegs on top of
 the outrigger float.’
- (346) Gai a Vave ga basa ange gi ana dama ga hai ange,
 then PN Vave PRSP talk DIR.DIST to 3SG.GEN.A child PRSP say DIR.DIST
 ‘Then Vave talked to his children and said,’
- (347) De-nei loo, dagu mee ne tala adu laa gi goodou
 DET-PROX EMPH DET-1SG.GEN.A thing PFV tell DIR.MED DIST to 2PL
 ‘This is it, the thing that I told you about’
- (348) gu dae mai nei. De-nei donu de iga e gaavee au.
 INC arrive DIR.PROX PROX DET-PROX truly DET fish IPFV send.CIA 1SG
 ‘has arrived. This is the fish that was sent to take me away.’
- (349) Gai goodou ga loo-age ai gi tae age gi de henua.
 then 2PL PRSP go.PL-up OBL SBJV reach.PL up to DET island
 ‘So that you can go up and reach the island.’
- (350) Taholaa e noho mai huu i ama.
 DET.whale IPFV live DIR.PROX when PREP outrigger.float
 ‘The whale remained at the floater.’

- (351) Gai a Vave ga ... ga hai ange
 then PN Vave PRSP PRSP say DIR.DIST
 'Then Vave said'
- (352) De kaba e basa ange au gi agu dama e tala ange agu muna
 DET wait IPFV talk DIR.DIST 1SG to 1SG.GEN.A child IPFV tell DIR.DIST 1SG.GEN.A word
 gi odi ange gi gilaadeu gai ga basa adu naa huu au gi de goe bolo
 SBJV empty DIR.DIST to 3PL then PRSP speak DIR.MED MED when 1SG to DET 2SG COMP
 gu lava gai koe ga kave ai loo au ma dali goe.
 INC finish then 2SG PRSP take OBL EMPH 1SG with 2SG
 'Wait for me to talk to my children and say my final words to them, and I will tell you
 when I'm done so that you can take me with you.'
- (353) Gai ia ga tala tala ange ana muna gi ana dama gu lava gai
 then 3SG PRSP say say DIR.DIST 3SG.GEN.A word to 3SG.GEN.A child INC finish then
 taholaa ga hhangamai de ngudu i ama delaadeu moni
 DET.whale PRSP open DIR.PROX DET mouth PREP outrigger.float DET-3PL.GEN canoe
 'So he told his final words to his children, and when he finished, the whale opened its
 mouth from the outrigger side of their canoe'
- (354) ga haga-mmidi ia go Vave gu doo ange gi lote ngudu o taholaa.
 PRSP CAUS-suck 3SG COP.FOC Vave INC fall DIR.DIST to inside.DET mouth GEN.O DET.whale
 'and sucked Vave into the mouth of the whale'
- (355) Aagai ia ga hai ange gi taholaa de kaba de gaadia ange oo niho.
 then 3SG PRSP say DIR.DIST to DET.whale DET wait DET bite.CIA DIR.DIST 2SG.GEN.O teeth
 'And he told the whale, don't close your teeth yet'
- (356) Gai de kaba de dugu iho lu-oo malau ngudu e hagapuni ange
 then DET wait DET put down DET.DU-2SG.GEN.O lip mouth IPFV join DIR.DIST
 ai lu-oo malau ngudu.
 OBL DET.DU-2SG.GEN.O lip mouth
 'And wait to lower your lips, don't close your lips.'
- (357) Gai au ga hai ange nei muna magavaa niho.
 then 1SG PRSP say DIR.DIST PROX word between teeth
 'I will say my last words between the teeth.'

- (358) De-nei d-ogu boolonga haga-odi ange gi agu dama.
 DET-PROX DET-1SG.GEN.O testament CAUS-empty DIR.DIST to 3SG.GEN.A child
 ‘This is my last testament to my children.’
- (359) Gai a Vave ga basa, ia gu dagodo i lote ngudu o taholaa i
 then PN Vave PRSP talk 3SG INC lay PREP inside.DET mouth GEN.O DET.whale PREP
 de masavaa laa.
 DET time DIST
 ‘So Vave spoke, he was inside the mouth of the whale at that time.’
- (360) Taholaa ga kadi ange ono niho gai tigi hagapuni mai
 DET.whale PRSP bite DIR.DIST 3SG.GEN.O teeth then not.yet join DIR.PROX
 lu-oono malau ngudu.
 DET.DU-3SG.GEN.O lip mouth
 ‘The whale closed its teeth, but didn’t yet close its lips.’
- (361) Gai ia ga basa mai ga hai mai d-ono boolonga gi ana
 then 3SG PRSP talk DIR.PROX PRSP do DIR.PROX DET-3SG.GEN.O testament to 3SG.GEN.A
 dama ga hai ange,
 child PRSP say DIR.DIST
 ‘So he spoke and gave his testament to his children and said,’
- (362) Ga loo-age naa huu goodou ga tau i de henua, ga lava i de
 PRSP go.PL-up MED when 2PL PRSP arrive.PL PREP DET island PRSP finish PREP DET
 doo ange d-oodou moni ma oodou goloa alodahi gi uda gai goodou
 drop DIR.DIST DET-2PL.GEN canoe and 2PL.GEN supplies all to inland then 2PL
 ga dugu de maduu
 PRSP put DET coconut.seed
 ‘When you go up and arrive at the island, and you’ve finished placing your canoe and all
 your supplies inland, you will place the coconut seedling’
- (363) i gaogao doodou hale gai.
 PREP near DET-2PL.GEN house eat
 ‘near your feasting house.’

- (364) Ga dugua naa huu goodou de maduu ga somo gai ga lau valu naa
 PRSP put.CIA MED when 2PL DET coconut.seed PRSP grow then PRSP leaf eight MED
 huu gai gu dau taholaa.
 when then INC reach DET.whale
 ‘After you place the coconut seedling, it will grow, and when it has eight leaves, the whale
 will arrive.’
- (365) Gai ga dau naa huu taholaa gai go Dehegevaealigi e ohaa.
 then PRSP reach MED when DET.whale then COP.FOC Dehegevaealigi IPFV break
 ‘And when the whale arrives, it is Dehegevaealigi who will cut it open.’
- (366) E dee go Deagu gai go Dehegevaealigi.
 IPFV NEG COP.FOC Deagu then COP.FOC Dehegevaealigi
 ‘It cannot be Deagu, it must be Dehegevaealigi.’
- (367) Gai gilaadeu ga uaa ange gi de-laadeu damana.
 then 3PL PRSP yes DIR.DIST to DET-3PL.GEN father
 ‘So they agreed with their father.’
- (368) Gai taholaa, gai a Vave ga basa ange gi taholaa gi hagapuni-dia
 then DET.whale then PN Vave PRSP speak DIR.DIST to DET.whale SBJV join-CIA
 mai loo lu-oono malau ngudu.
 DIR.PROX EMPH DET.DU-3SG.GEN.O lip mouth
 ‘Then as for the whale, Vave told the whale to close its lips.’
- (369) Gai taholaa ga hagapuni mai lu-oono malau ngudu
 then DET.whale PRSP join DIR.PROX DET.DU-3SG.GEN.O lip mouth
 ‘So the whale closed its lips’
- (370) ga haga-llilo ai ono niho gai ia ga haga-mounu gi lalo.
 PRSP CAUS-disappear.PL OBL 3SG.GEN.O tooth then 3SG PRSP CAUS-separate.from to under
 ‘and covered its teeth and it submerged into the water.’
- (371) Gai ana dama ga haga-duu de-laadeu laa ga dele mai gi de henua.
 then 3SG.GEN.A child PRSP CAUS-stand DET-3PL.GEN DIST PRSP sail DIR.PROX to DET island
 ‘So his children hoisted their sail and sailed to the island.’

- (372) Gilaadeu gu aahe mai donu bolo e loomai gi de henua nei.
 3PL INC return.PL DIR.PROX truly COMP IPFV come-DIR.PROX to DET island PROX
 ‘They turned around to come back to this island.’
- (373) Gaeuli ga ahe ange gi d-ana hegau mau ne kave ai laa gilaadeu
 Gaeuli PRSP return DIR.DIST to DET-3SG.GEN.A work usual PFV take OBL DIST 3PL
 go de balia.
 COP.FOC DET navigator
 ‘Gaeuli returned to his original duty to take them, as the navigator.’
- (374) Go ia e diiloo madaa moni olaadeu e hulo gi agina.
 COP.FOC 3SG IPFV look.CIA front canoe 3PL.GEN.O IPFV go.PL to there
 ‘He is the one looking after the direction that they are going in.’
- (375) Gai a Deagu aa-nei ana hegau e hai go de sigi saele
 then PN Deagu PL-PROX 3SG.GEN.A work IPFV do COP.FOC DET tack.canoe around
 de-laadeu laa.
 DET-3PL.GEN sail
 ‘And as for Deagu, his job was to tack their sail.’
- (376) Gai ga hano hano huu gu hai sala.
 then PRSP go.SG go.SG when INC mistake
 ‘But as they were sailing, there were some mistakes.’
- (377) Aagai de-laadeu damana ga bole ange ga hai ange gi a Deagu,
 then DET-3PL.GEN father PRSP scold DIR.DIST PRSP say DIR.DIST to PN Deagu,
 ‘And their father scolded them and said to Deagu,’
- (378) Hakadanga goe, koe e dee bei donu d-agu dama ne hano laa ga dee
 CAUS.shame 2SG 2SG IPFV NEG like truly DET-1SG.GEN.A child PFV go.SG DIST PRSP NEG
 maleva i ugu daha go Iaidemalo.
 present PREP 1SG.GEN.O place COP.FOC Iaidemalo
 ‘Shame on you, you are not like my son who went away from me, Iaidemalo.’
- (379) Koe e hoia e goe, tuudae i Aalohi.
 2SG IPFV stop.it ERG 2SG DET.defecate PREP Aalohi
 ‘You are useless, the shit of Aalohi.’

- (380) Deai donu au angaanga mee e iloo.
no truly 2SG.GEN.A body thing IPFV know
'You don't know anything.'
- (381) Gai gilaadeu ga loomai ai loo,
then 3PL PRSP come.PL OBL EMPH
'So they continued on their way,'
- (382) gai taholaa gu kave a Vave ma gu hano ai.
then DET.whale INC take PN Vave and INC go.SG OBL
'and the whale took Vave and left.'
- (383) Gilaadeu gu dee he-gide i de masavaa laa.
3PL INC NEG RCPR-see PREP DET time DIST
'That was the last time they saw each other.'
- (384) Gilaadeu ga loo-mai loo-mai huu Gaeuli ga gaa-mai
3PL PRSP come.PL-DIR.PROX come.PL-DIR.PROX when Gaeuli PRSP bring-DIR.PROX
de-laadeu madaa moni haga-soe mai donu huu gi de henua nei.
DET-3PL.GEN front canoe CAUS-straight DIR.PROX only to DET island PROX
'As they sailed and sailed, Gaeuli steered their canoe directly to this island'
- (385) Ga aho age huu taiao laa, sula loo de henua.
PRSP dawn up when DET.morning DIST appear EMPH DET island
'When morning came, the island appeared.'
- (386) Gilaadeu ga madaa moni mai gi de ava.
3PL PRSP front canoe DIR.PROX to DET channel
'They steered the canoe toward the channel.'
- (387) Gilaadeu ga loo-mai loo-mai huu gu tae mai gi de
3PL PRSP come.PL-DIR.PROX come.PL-DIR.PROX when INC reach.PL DIR.PROX to DET
ava
channel
'They came and came and reached the channel'
- (388) bolo e loo-iho gi dai.
COMP IPFV come.PL-down to lagoon
'and they came into the lagoon.'

- (389) Gai ga loo-iho huu gilaadeu, gu hai sala alaadeu mee ne hai, dahi hanu
 then PRSP come.PL-down when 3PL INC mistake 3PL.GEN.A thing PFV do one some
 beau i de laangi laa, gilaadeu gu leva gi uda i lote sugi beau
 wave PREP DET day DIST 3PL INC throw.in.air to inland PREP inside.DET tail wave
 i ngaage,
 PREP north
 ‘As they came in, something bad happened because of the strong waves on that day, they
 were thrown onto the reef by the crest of a wave on the left side of the channel.’
- (390) ga mahagi ai de-laadeu ama.
 PRSP break.off OBL DET-3PL.GEN outrigger.float
 ‘and their outrigger float broke off.’
- (391) Gai de masavaa ne mahagi ai de-laadeu ama, ga doo gee i
 then DET time PFV break.off OBL DET-3PL.GEN outrigger.float PRSP fall away PREP
 de-laadeu moni, gai gilaadeu gu gidee de labodo laumalie mmao gu sao
 DET-3PL.GEN canoe then 3PL INC see DET eel big vast INC go.out
 mai i lote ama ma gu savini i hongatai ma gu hano
 DIR.PROX PREP inside.DET outrigger.float and INC run PREP top DET.sea and INC go.SG
 ai.
 OBL
 ‘And when their outrigger float broke off and fell away from their canoe, they saw the
 huge eel come out from inside the float and run away onto the ocean and leave.’
- (392) De-laa ai gai Gaeuli e iloo e ia bolo tangada madumadua i
 DET-DIST OBL then Gaeuli IPFV know ERG 3SG COMP DET.person old.RED PREP
 Moodolago e dao duu gaha laa ma de hhuge ana duu gaha
 Mortlocks IPFV cover coconut.husk DIST and DET uncover 3SG.GEN.A coconut.husk
 de-laa d-ana mee ne vange laa gi lote ama o
 DET-DIST DET-3SG.GEN.A thing PFV give DIST to inside.DET outrigger.float GEN.O
 de-laadeu moni gi dee dau henua ai.
 DET-3SG.GEN canoe SBJV NEG reach island OBL
 ‘And so, Gaeuli realized that the old man in the Mortlocks, who was soaking and uncov-
 ering his coconut husks, that was what he gave them inside the outrigger float of their
 canoe so that they would not make landfall.’

- (393) De-laa ai de labodo laa gu hano, gai gilaadeu gu tae mai gi de
 DET-DIST OBL DET eel DIST INC go.SG then 3PL INC reach.PL DIR.PROX to DET
 henua nei.
 island PROX
 ‘So that eel left, and they reached this island.’
- (394) Gilaadeu ga loo-mai nnoho i de henua nei.
 3PL PRSP come.PL-DIR.PROX live.PL PREP DET island PROX
 ‘They came and stayed on this island.’
- (395) Nnoho nnoho nnoho huu gilaadeu, gu dae age ga se daane Hagadauanga,
 live.PL live.PL live.PL when 3PL INC reach up PRSP COP.SG man Hagadauanga
 ‘As they stayed and stayed there, Hagadauanga grew up and became a man.’
- (396) go tama madua laa a Iaidemalo.
 COP.FOC DET.child old DIST GEN.A Iaidemalo
 ‘the oldest child of Iaidemalo.’
- (397) Gai ia gu manadua age de lodo e ssala dahi bodu m-oona.
 then 3SG INC think.CIA up DET want IPFV search.for one spouse BEN-3SG.GEN.O
 ‘He decided to look for a wife for himself.’
- (398) Gai ia ga hano ai loo ssala dahi bodu m-oona
 then 3SG PRSP go.SG OBL EMPH search.for one spouse BEN-3SG.GEN.O
 ‘So he went and searched for a wife’
- (399) gu gidee e ia gai ia ga hai d-ono bodu ga nnoho ai gilaau.
 INC see ERG 3SG then 3SG PRSP make DET-3SG.GEN.O spouse PRSP live.PL OBL 3DU
 ‘and when he found one, he got married and they lived together.’
- (400) Gai ga nnoho nnoho huu gilaau i dahi laangi gai gilaau ma d-ono
 then PRSP live.PL live.PL when 3DU PREP one day then 3DU and DET-3SG.GEN.O
 bodu ga maanadu age bolo, gilaau ga hulo e hai hanu hegau ma-alaau,
 spouse PRSP think up COMP 3DU PRSP go.PL IPFV do some work BEN-3DU.GEN.A
 laa de adu modu.
 DIST DET group.of.islets
 ‘As they lived there, one day he and his wife decided that they should go and do some
 work for themselves on the other islets.’

- (401) Gilaau ga hulo. Delaau ngado mai i ngaiho, Tuila.
 3DU PRSP go.PL DET-3DU limit DIR.PROX PREP south Tuila
 ‘They went and they ended up at Tuila.’
- (402) Gilaau nogo vvele saele ai hanu mee ma e hai saele ai de-laau
 3DU IPFV clear.PL around OBL some thing and IPFV do around OBL DET-3DU.GEN
 haga-mouli,
 CAUS-live
 ‘They had cleared out some land and they stocked up on their food.’
- (403) hagi mee ai ma e sala somo saele ai.
 pick.fruit thing OBL and IPFV look.for coconut.apple around OBL
 ‘picking coconut and collecting coconut apples.’
- (404) Hai hai ai huu alaau hegau i de laangi laa, gu ahiahi de mee.
 do do OBL when 3DU.GEN.A work PREP DET day DIST INC evening DET thing
 ‘They did their work that day until evening came.’
- (405) Gai gilaau ga loo-iho gi dai gi de-laau moni.
 then 3DU PRSP come.PL-down to lagoon to DET-3DU.GEN canoe
 ‘So they went down to the shore to their canoe.’
- (406) Ga loo-iho gilaau, de-laau masavaa ne loo-iho ai gi de-laau
 PRSP come.PL-down 3DU DET-3DU.GEN time PFV come.PL-down OBL to DET-3DU.GEN
 moni i dai, gai de laa gu ulu gi lote lausedi.
 canoe PREP lagoon then DET sun INC enter to inside.DET salt.water
 ‘As they went down, when they went down to their canoe at the shore, the sun sank fully
 into the water.’
- (407) Maalama dua de laa.
 light after DET sun
 ‘It was dusk.’
- (408) Gai de laangi laa kona donu de malino.
 then DET day DIST much truly DET calm
 ‘And that day, the weather was so calm.’

- (409) Gai gilaau ga hagataba age i olaau ngudu ngaadahi i de masavaa laa
 then 3DU PRSP say up PREP 3DU.GEN.O mouth both PREP DET time DIST
 bolo molomolo iho daahagi.
 COMP clear down calm.sea
 ‘And they said to each other then, how clear and calm the sea is.’
- (410) De muna nei bolo molomolo iho daahagi gu puni tai ma de langi i de
 DET word PROX COMP clear down calm.sea INC join DET.sea and DET sky PREP DET
 malino o de laangi laa.
 calm GEN.O DET day DIST
 ‘This word *molomolo iho daahagi* means that the sea and the sky are joined together be-
 cause of how calm it is on that day.’
- (411) Gai e hanu dala langi e tagi saele i muli o de laa ne
 then IPFV some piece.of sky IPFV suspend around PREP behind GEN.O DET sun PFV
 lilo ai laa gi lote dai i de ahiahi laa.
 disappear OBL DIST to inside.DET lagoon PREP DET evening DIST
 ‘And there were some pieces of clouds lingering after the sun disappeared into the ocean
 that evening.’
- (412) Se aha de mahamaha danuaa huu.
 COP.SG what DET beautiful good when
 ‘How beautiful it was.’
- (413) Gai de bodu o Hagadauanga ga hagadaba age i d-ono ngudu,
 then DET spouse GEN.O Hagadauanga PRSP say up PREP DET-3SG.GEN.O mouth
 ‘So the wife of Hagadauanga said,’
- (414) Ee laa, au gu lodo loo e gage ange e noho i hongaa talaa langi
 wow 1SG INC want EMPH IPFV climb DIR.DIST IPFV live PREP top DET.piece sky
 mmea danuaa laa ma de mahamaha.
 red good DIST and DET beautiful
 ‘Wow, I wish I could climb up and sit on that red piece of cloud that is so beautiful.’
- (415) Gai Hagadauanga ga hai ange gi d-ono bodu,
 then Hagadauanga PRSP say DIR.DIST to DET-3SG.GEN.O spouse
 ‘And Hagadauanga said to his wife’

- (416) Gai gu aha, ga loo-age gidaau e hai gi bei oo lodo?
 then why PRSP come.PL-up 3DU PRSP do to like 2SG.GEN.O want
 ‘Why not, shall we go and do as you wish?’
- (417) Gilaaau ga loo-mai gi moolau i de masavaa laa.
 3DU PRSP come.PL-DIR.PROX SBJV quick PREP DET time DIST
 ‘They came quickly at that time.’
- (418) Gilaaau ga tae mai donu huu i de masavaa laa ga dada de oo
 3DU PRSP reach.PL DIR.PROX truly when PREP DET time DIST PRSP pull DET ration
 ga hulo,
 PRSP go.PL
 ‘They got back and picked taro for the journey and left.’
- (419) kave hogi dangada be go ai ne llodo laa e hulo ma dali gilaaau
 take also person COMP.INT COP.FOC who PFV want.PL DIST IPFV go.PL with 3DU
 i de-laau moni i de boo laa.
 PREP DET-3DU.GEN canoe PREP DET night DIST
 ‘taking anyone who wanted to go with them in their canoe that night.’
- (420) Gilaadeu gu maallanga ga hulo. Gilaadeu ga hulo ai loo.
 3PL INC depart.PL PRSP go.PL 3PL PRSP go.PL OBL EMPH
 ‘They departed and left, they all left.’
- (421) Ga hulo hulo hulo hulo hulo dee maua gi heda e ange gi talaa langi
 PRSP go.PL go.PL go.PL go.PL go.PL NEG be.able SBJV meet DIR.DIST SBJV DET.piece sky
 a d-ono bodu ne lodo laa bolo ia e gage ange e noho i
 GEN.A DET-3SG.GEN.O spouse PFV want DIST COMP 3SG IPFV climb DIR.DIST IPFV live PREP
 hong a talaa langi mahamaha laa ma tanuaa.
 top DET.piece sky beautiful DIST and DET.good
 ‘And they sailed and sailed and sailed, but they couldn’t reach the piece of the sky that
 his wife wished for, that she would climb up and sit on the piece of the sky that was so
 beautiful.’
- (422) Gilaadeu ga tele saele ai donu huu i de moana be laa ga sigisigi
 3PL PRSP sail.PL around OBL only PREP DET open.sea like DIST PRSP sail.RED
 saele ai.
 around OBL
 ‘They just sailed around the open sea like that continuously.’

- (423) E hanu henua olaadeu e hedaē ange gi agina gai gilaadeu e dee llodo
 IPFV some island 3PL.GEN.O IPFV meet DIR.DIST to there then 3PL IPFV NEG want.PL
 e loo-age gi agina hidinga gilaadeu e dee se hanonga sala henua,
 IPFV come.PL-up to there because 3PL IPFV NEG COP.SG time search.for island
 se hanonga e hulo e ssala talaa langi laa e haga-nnoho
 COP.SG time IPFV go.PL IPFV search.for.PL DET.piece sky DIST IPFV CAUS-live.PL
 ange gi agina d-ono bodu go Hagadauanga
 DIR.DIST to there DET-3SG.GEN.O spouse COP.FOC Hagadauanga
 ‘They came to several islands, but they didn’t want to go to them, because they were not
 sailing to look for land, but to look for the piece of sky for Hagadauanga’s wife to sit on’
- (424) gi bei ai ono lodo ne tala laa i d-ono ngudu i dai de
 to like OBL 3SG.GEN.O want PFV tell DIST PREP DET-3SG.GEN.O mouth PREP lagoon DET
 modu go Tuila.
 islet COP.FOC Tuila
 ‘so that it would happen like she wished for, as she said on the shore of the islet of Tuila.’
- (425) Gilaadeu ga hulo ai huu, ga hulo hulo hulo huu, gu paa age gi uda
 3PL PRSP go.PL OBL when PRSP go.PL go.PL go.PL when INC close.PL up to inland
 i dahi henua.
 PREP one island
 ‘And as they went, as they sailed and sailed, they came near an island.’
- (426) Gai denga hitegaiaa ga loo-iho ga gai de bodu o Hagadauanga ma
 then DET.PL demon PRSP come.PL-down PRSP eat DET wife GEN.O Hagadauanga and
 gau i de-laau moni
 people PREP DET-3DU.GEN canoe
 ‘And some *hitegaiaa* came down and ate Hagadauanga’s wife and the people in their ca-
 noe’
- (427) gu odi i de maakau.
 INC empty PREP DET die.PL
 ‘and they all died.’
- (428) Gai go ia sogosogo donu huu go Hagadauanga e noho i de moni.
 then COP.FOC 3SG alone only COP.FOC Hagadauanga IPFV live PREP DET canoe
 ‘Only Hagadauanga alone was left in the canoe.’

- (429) Gai ia gu han-age dahi maanadu i ono lodo i de masavaa laa bolo
 then 3SG INC go.SG-up one thought PREP 3SG.GEN.O inside PREP DET time DIST COMP
 ia ga gaa-mai d-ono dau ama e siga ai d-ana gatae.
 3SG PRSP bring DET-3SG.GEN.O mast.stay IPFV weave.net OBL DET-3SG.GEN.A fishing.net
 ‘And he got an idea that he would take his sail line and weave a fishing net with it.’
- (430) Gai ia ga dugu mai d-ono dau ama i ama
 then 3SG PRSP put DIR.PROX DET-3SG.GEN.O mast.stay PREP outrigger.float
 ‘So he took his sail line from the dam side of the canoe’
- (431) gai ia ga siga d-ana gatae.
 then 3SG PRSP make.net DET-3SG.GEN.A fishing.net
 ‘and he wove his fishing net.’
- (432) Gu lava gai ia ga gaau ange gi d-ono bou.
 INC finish then 3SG PRSP fasten DIR.DIST to DET-3SG.GEN.O mast
 ‘When he finished, he fastened it to the mast.’
- (433) Gai de masavaa laa gai denga hitegaiaa gu loo-iho dagi-dahi donu huu
 then DET time DIST then DET.PL demon INC come.PL-down each-one only
 ‘So then the *hitegaiaa* came one at a time’
- (434) go hidinga go d-ono dubuna donu go Vave ne haia laa
 COP.FOC reason COP.FOC DET-3SG.GEN.O grandparent truly COP.FOC Vave PFV do.CIA DIST
 ga dagodo be laa
 PRSP lay like DIST
 ‘because his grandfather Vave that made it happen that way’
- (435) gi dee magau ai ia go Hagadauanga gi dae mai ange ai ia gi
 SBJV NEG die OBL 3SG COP.FOC Hagadauanga SBJV reach DIR.PROX DIR.DIST OBL 3SG to
 de henua e gaa-mai d-ono longo.
 DET island IPFV bring-DIR.PROX DET-3SG.GEN.O news
 ‘so that Hagadauanga wouldn’t die and he would reach the island and bring his news.’
- (436) Gai ia ga hai hai ai donu huu denga hitegaiaa laa gu odi gu deai ange
 then 3SG PRSP do do OBL only DET.PL hitegaiaa DIST INC empty INC no DIR.DIST
 mee e loo-iho.
 thing IPFV come.PL-down
 ‘So he continued to catch the *hitegaiaa* until no more of them came down.’

- (437) Gai de muna nei de hitegaiaa ni mee be ni biho daodao laa.
 then DET word PROX DET demon COP.PL thing like COP.PL head wahoo DIST
 ‘This word *hitegaiaa*, they’re like the head of the wahoo.’
- (438) Gai ni eidu.
 then COP.PL ghost
 ‘They’re ghosts.’
- (439) Deai donu angaanga, ni biho donu huu, gai e bei donu de biho o
 no truly body COP.PL head only then IPFV like truly DET head GEN.O
 taodao ma lu-oono malau ngudu e hanu ono niho.
 DET.wahoo and DET.DU-3SG.GEN.O lip mouth IPFV some 3SG.GEN.O tooth
 ‘There’s no body, only a head, and it’s like the head of a wahoo and its two lips and its teeth.’
- (440) De mee haga-odi, gai ia ga dangage age i de lave i d-ana
 DET thing CAUS-empty so 3SG PRSP look.up up PREP DET stuck.on PREP DET-3SG.GEN.A
 buulou ga baalasi gi lausedi ga galo age taholaa gu dagodo mai i
 catch PRSP press.on to salt.water PRSP look up DET.whale INC lay DIR.PROX PREP
 dai de gelegele o de henua laa.
 lagoon DET sand GEN.O DET island DIST
 ‘At the last one, he looked up at what he had caught and pushed it into the water, and he saw the whale that was laying on the beach at that island.’
- (441) Go d-ono dubuna donu go Vave de-laa gu ahe mai
 COP.FOC DET-3SG.GEN.O grandparent truly COP.FOC Vave DET-DIST INC return DIR.PROX
 i de bouli.
 PREP DET darkness
 ‘It was really his grandfather Vave who had returned from the afterlife.’
- (442) De masavaa nei gai a Vave gu dee hagabinga loo d-ono ingoo bolo
 DET time PROX then PN Vave INC NEG be.called EMPH DET-3SG.GEN.O name COMP
 go Vave de-laa gai go Ssamouli, Ssamoulidaane,
 COP.FOC Vave DET-DIST then COP.FOC Ssamouli Ssamoulidaane
 ‘And now, Vave was no longer named Vave, he was called Ssamouli, Ssamoulidaane.’
- (443) go hidinga ia gu humai i de bouli
 COP.FOC reason 3SG INC come.SG PREP DET darkness
 ‘because he had come from the afterlife’

- (444) oona ne hakide ange ai nei gi d-ono mogobuna go
 3SG.GEN.O PFV CAUS.see DIR.DIST OBL PROX to DET-3SG.GEN.O grandchild COP.FOC
 Hagadauanga.
 Hagadauanga
 ‘to reveal himself to his grandson Hagadauanga.’
- (445) Gai ia gu hagaagahi mai d-ono mogobuna
 then 3SG INC call DIR.PROX DET-3SG.GEN.O grandchild
 ‘So he called to his grandson’
- (446) ga hai ange, E Hagadauanga!
 PRSP say DIR.DIST VOC Hagadauanga
 ‘and said, Hagadauanga!’
- (447) Humai loo e d-ogu mogobuna, gage mai gi d-ogu dua
 come.SG EMPH VOC DET-1SG.GEN.O grandchild climb DIR.PROX to DET-1SG.GEN.O back
 gai au ga gaav-age goe e loo-age ai gidaau e gaav-age d-oo
 then 1SG PRSP bring-up 2SG PRSP come.PL-up OBL 1DU.INCL IPFV bring-up DET-2SG.GEN.O
 longo.
 news
 ‘Come, my grandson, climb on my back and I will bring you home, and we will go back
 to deliver your news.’
- (448) Gai d-ono mogobuna ga basa haga-mao lunga age gi d-ono
 then DET-3SG.GEN.O grandchild PRSP speak CAUS-high above up to DET-3SG.GEN.O
 dubuna ga hai ange,
 grandparent PRSP say DIR.DIST
 ‘And his grandson spoke harshly to his grandfather and said,
- (449) Go de aha? Ga magau ai naa d-ogu bodu ga odi gau i
 COP.FOC DET what PRSP die OBL IRR DET-1SG.GEN.O spouse PRSP empty people PREP
 d-ogu moni i de maakau gai koe ga humai e hakide mai gi
 DET-1SG.GEN.O canoe PREP DET die.PL so 2sg PRSP come.SG PRSP CAUS.see DIR.PROX to
 de au be naa e basa mai ai gi de au?
 DET 1SG like MED IPFV talk DIR.PROX OBL to DET 1SG
 ‘How come? My wife has died, and everybody on my canoe has died, and you come and
 reveal yourself to me like this and talk to me?’

- (450) Au e dee han-age madali goe.
 1SG IPFV NEG go.SG-up with 2SG
 ‘I won’t go with you.’
- (451) Gai taholaa ga langa d-ono sugi ga hagaili Hagadauanga gu lilo
 then DET.whale PRSP lift DET-3SG.GEN.O tail PRSP hit Hagadauanga INC disappear
 gi lalo i lote gelegele i dai de henua laa.
 to under PREP inside.DET sand PREP lagoon DET island DIST
 ‘So the whale lifted its tail and smacked Hagadauanga, and he disappeared inside the sand
 on the lagoon-side of that island.’
- (452) Taholaa ga hagammene ga ahe gi de moana.
 DET.whale PRSP go.backwards PRSP return to DET open.sea
 ‘The whale retreated and returned to the sea.’
- (453) Aa-naa ai donu huu agu mee e mau i de tala, e hanu ange
 PL-MED OBL only 1SG.GEN.A thing IPFV be.able PREP DET say IPFV some DIR.DIST
 donu mee, gai au gu dee maua loo i de tala, gi odi gi muli, aa-nei
 truly thing then 1SG INC NEG be.able EMPH PREP DET tell SBJV empty to behind PL-PROX
 donu huu agu momo mee ne mau i de tala, ne iloo ga tala adu,
 only 1SG.GEN.A few thing PFV be.able PREP DET tell PFV know PRSP tell DIR.MED
 gu lava naa i de tala adu.
 INC finish MED PREP DET tell DIR.MED
 ‘These are the things I am able to tell, there are some other things, but I can’t remember
 them, to finish the story. These are the few things that I am able to tell that I know, that I
 already shared with you.’

A.3 Tailalahaodengadubua (11-1) — Molia

Speaker: Molia

Date recorded: Spring 1966

Location: Nukuoro Atoll, Pohnpei State, Federated States of Micronesia

Recording information: Reel 11, story 1

Molia tells the story of Tailalahaodengadubua, a demi-god who is raised from a blood clot that floats to the islet of Gausema. Tailalahaodengadubua goes on a quest to bring back the spirit of the plants of Nukuoro, which was stolen by a group of demons called *hitegaiaa*, and defeats several powerful beings along the way.

- (1) Ga noho laa huu e dahi hai bodu.
 PRSP live DIST when IPFV one make spouse
 ‘There once lived a married couple.’
- (2) Taane laa d-ono ingoo go Mauadodo.
 DET.man DIST DET-3SG.GEN name COP.FOC Mauadodo
 ‘The man’s name was Mauadodo.’
- (3) Ga noho gai ga mee huu gu hai dama d-ono bodu.
 PRSP live then PRSP thing when INC make child DET-3SG.GEN spouse
 ‘As they stayed, something happened and his wife became pregnant.’
- (4) Gai dahi laangi huu gai gilaau gu hulo gi Senugu.
 then one day when then 3DU INC go.PL to Senugu
 ‘So one day, they went to Senugu.’
- (5) Ga hulo huu gilaau gi Senugu, gai d-ono bodu ga hai ange bolo ia
 PRSP go.PL when 3DU to Senugu then DET-3SG.GEN spouse PRSP say DIR.DIST COMP 3SG
 ga hano e hongaga gelegele i lausedi.
 PRSP go.SG IPFV defecate PREP salt.water
 ‘When they went to Senugu, his wife said that she was going to poop in the ocean.’
- (6) Gai ga hano huu ia ga hongaga gelegele i lausedi, gai dana dama
 then PRSP go.SG when 3SG PRSP defecate PREP salt.water then DET-3SG.GEN child
 gu ssege.
 INC miscarry
 ‘But when she pooped in the water, she miscarried her child.’
- (7) Gai ga ssege huu dana dama, gai tibaa dodo laa ga dahea ga
 then PRSP miscarry when DET-3SG.GEN child then DET.clot blood DIST PRSP drift PRSP
 hano ga dau age i Gausema.
 go.SG PRSP reach up PREP Gausema
 ‘And when she miscarried, a clot of blood drifted and went and reached Gausema.’
- (8) Gai Tailalahaodengadubua ga hano iho
 then Tailalahaodengadubua PRSP go.SG down
 ‘And Tailalahaodengadubua went down’

- (9) gu gidee e ia.
INC see ERG 3SG
'and found it.'
- (10) Gai ia ga gaav-age, tibaa dodo laa.
then 3SG PRSP bring-up DET.clot blood DIST
'And he took it to shore, the blood clot.'
- (11) Ga hhao ange gi lote gi lote kosi i mua.
PRSP put.inside DIR.DIST to inside.DET to inside.DET mollusk.sp PREP front
'He put it inside a KOSI shell first.'
- (12) Ga dugudugu ai ga lava ga hhao ange gi lote bibi.
PRSP put.RED OBL PRSP finish PRSP put.inside DIR.DIST to inside.DET mollusk.sp
'He left it there, and then her put it inside of a *bibi* shell.'
- (13) Ga lava ga hhao ange gi lote kasi.
PRSP finish PRSP put.inside DIR.DIST to inside.DET mollusk.sp
'Then he put it inside of a *kasi* shell.'
- (14) Ga lava ga hhao ange gi lote duungaa gima, gu dee oo, ga
PRSP finish PRSP put.inside DIR.DIST to inside.DET half.clam.shell INC NEG fit.into PRSP
lava gai ia ga hhao ange gi lote duu dange, gu dee oo
finish then 3SG PRSP put.inside DIR.DIST to inside.DET half giant.clam INC NEG fit.into
ga lava gai ia ga kave gi lote mada loolodo i dua ga dugu ai.
PRSP finish then 3SG PRSP take to inside.DET reef.depression PREP back PRSP put OBL
'Then he put it inside a half of a *gima* shell until it didn't fit anymore, so he put it inside
of a half of a *dange* (giant clam) shell until it didn't fit anymore, so then he took it to a
depression in the reef on the ocean-side and finally placed it there.'
- (15) Gai ga dugu huu ia, aagai de mee laa gu laumalie.
then PRSP put when 3SG then DET thing DIST INC large
'When he put it there, the thing became larger.'
- (16) Gu se dangada.
INC COP.SG person
'It became a person.'

- (17) Aagai ia ga haga-sulu, ga gave iho gi ono daha i dai.
 then 3SG PRSP CAUS-dive PRSP take down to 3SG.gen place PREP lagoon
 'So he retrieved it from the water and took it back to where he lived by the lagoon.'
- (18) Gai ia ga haga-ingoo ange bolo d-ono ingoo, go
 then 3SG PRSP CAUS-name DIR.DIST COMP DET-3SG.GEN name COP.FOC
 Tailalahaodengadubua.
 Tailalahaodengadubua
 'And he named him Tailalahaodengadubua.'
- (19) D-ono ingoo donu go Iaigausema.
 DET-3SG.GEN name EMPH COP.FOC Iaigausema
 'His own name was Iaigausema.'
- (20) Gai gilaau ga nnoho ai loo.
 then 3DU PRSP live.PL OBL EMPH
 'So they lived there.'
- (21) Gai ia ga hai ange gi tama laa bolo, Iainei gai au ga tala adu nei
 then 3SG PRSP say DIR.DIST to DET.child DIST COMP now then 1SG PRSP tell DIR.MED PROX
 gi de goe, lu-oo maadua.
 to DET 2SG DET.DU-2SG.GEN parents
 'And he said to the child, Now I'm going to tell you who your parents are.'
- (22) Dahi laangi, gai gilaau ne loomai bolo e dada mee i Senugu.
 one day then 3DU PFV come.PL COMP IPFV pick thing PREP Senugu
 'One day, they came to pick taro in Senugu.'
- (23) Gai de hine laa ga hano gi lausedi, bolo e hongga gelegele ai.
 then DET woman DIST PRSP go.SG to salt.water COMP IPFV defecate OBL
 'And the woman went to the water to poop.'
- (24) Gai gu ssege goe, ga dahea mai gi kinei, gi Gausema.
 then INC miscarry 2SG PRSP drift DIR.PROX to here to Gausema
 'And you were miscarried, and you floated here, to Gausema.'

- (25) Gai au ga gaav-age goe, ga hhao ange gi lote duu kosi, ga
 then 1SG PRSP take-up 2SG PRSP put.inside DIR.DIST to inside.DET half mollusk.sp PRSP
 lava go lote duu bibi, ga lava go lote duu kasi,
 finish COP.FOC inside.DET half mollusk.sp PRSP finish COP.FOC inside.DET half mollusk.sp
 ga lava go lote duu gima, ga lava go lote duu
 PRSP finish COP.FOC inside.DET half horsehoof.clam PRSP finish COP.FOC inside.DET half
 dange, ga lava ga kave goe gi lote mada loolodo i dua, gu se
 giant.clam PRSP finish PRSP take 2SG to inside.DET reef.depression PREP back INC COP.SG
 dangada, gai au ga gaa-mai ai nei goe.
 person then 1SG PRSP bring-DIR.PROX OBL PROX 2SG
 ‘So I brought you to shore and put you inside a *kosi* shell, then inside a *bibi* shell, then
 inside a *kasi* shell, then inside a *gima* shell, then inside a *dange* shell, and then I put you
 inside a depression in the reef on the ocean-side until you became a person, and then I
 brought you here.’
- (26) Gai de masavaa laa, gai Nuguolo gu onge.
 then DET time DIST then Nukuoro INC famine
 ‘And at that time, Nukuoro was in a famine.’
- (27) Gu mmae denga nui, ma denga daogoli, ma denga gulu, ma denga
 INC pain DET.PL coconut.tree and DET.PL swamp.taro and DET.PL breadfruit and DET.PL
 manu alodahi hugadoo e hanu laa mee e gai ai, gu mmae.
 organism all above.all IPFV some DIST thing IPFV eat OBL INC pain
 ‘The coconut trees had withered, and the swamp taro, and the breadfruit, and each and
 every plant that produced food to eat had withered.’
- (28) Aagai Iaigausema ga maanadu age bolo, ia ga hai ange loo gi
 then Iaigausema PRSP think up COMP 3SG PRSP say DIR.DIST EMPH to
 Tailalahahaodengadubua, gi hano gi haahe ina mai, mouli o
 Tailalahahaodengadubua SBJV go.SG SBJV CAUS-return INA DIR.PROX life GEN.O
 dengaa manu.
 DET.PL.SUP organism
 ‘So Iaigausema decided that he would tell Tailalahahaodengadubua to go and bring back
 the life of all the plants.’
- (29) Gai dahi laangi huu, gai gu lo-adu denga daane e hulo e
 then one day when then INC come.PL-DIR.MED DET.PL man IPFV come.PL IPFV
 haga-ahe ina mai mouli o denga manu.
 CAUS-return INA DIR.PROX life GEN.O DET.PL organism
 ‘So one day, the men came to go and bring back the life of the plants.’

- (30) Aagai ia ga hai ange, han-age loo goe gi Hale ga noho ai.
 then 3SG PRSP say DIR.DIST go.SG-up EMPH 2SG to house PRSP live OBL
 ‘And he said, Go up to the main islet and stay there.’
- (31) Aagai ga loo-adu naa huu, ga loomai naa huu de gau
 then PRSP come.PL-DIR.MED IRR when PRSP come.PL-DIR.PROX MED when DET people
 naa e hulo, aagai koe ga hai ange bolo koe e hano.
 MED IPFV go.PL then 2SG PRSP do DIR.DIST COMP 2SG IPFV go.SG
 ‘And when you go, when the people come to leave the island, ask if you can go with them.’
- (32) Gai ga hai adu naa huu bolo e deai koe e dee bau ange koe se
 then PRSP do DIR.MED IRR when COMP IPFV no 2SG IPFV NEG capable DIR.DIST 2SG COP.SG
 gauligi, aagai ga dungagi adu naa huu tama a de hodooligi, gai koe
 child then PRSP nod DIR.MED IRR when DET.child GEN.A DET chief then 2SG
 ga hagamubu gi se lango, gai koe ga lele ga hano ga noho i hongga
 PRSP transfigure to COP.SG fly then 2SG PRSP fly PRSP go.SG PRSP sit PREP top
 de unudi i muli.
 DET prow PREP behind
 ‘And when they tell you no, you can’t come because you’re too young, and when the
 chief’s son nods to you, turn into a fly, and fly over and sit on the stern of the canoe.’
- (33) Gai ga hulo naa huu goodou, ga loage laa lote ava gi dua, ga
 then PRSP go.PL IRR when 2PL PRSP come.PL-up DIST inside.DET channel to back PRSP
 lilo naa huu de henua, aagai Saabuga gu noho ma gu hhuge ai ana
 disappear IRR when DET island then Saabuga INC sit and INC uncover OBL 3SG.GEN.A
 duu gaha.
 coconut.husk
 ‘And when you go, and as you go through the channel to the outside, and when the island
 disappears, Saabuga will sit and uncover his coconut husks.’
- (34) Aagai ga hai adu naa huu Saabuga gi goodou, Ga hulo naa goodou gi hee?
 then PRSP say DIR.MED MED when Saabuga to 2PL PRSP go.PL MED 2PL to where
 ‘And when Saabuga asks you, Where are you going?’
- (35) Gai goodou ga hai ange, Gimaadeu ga hulo nei e hagahe mai,
 then 2PL PRSP say DIR.DIST 1PL.EXCL PRSP go.PL PROX IPFV CAUS-return DIR.PROX
 mouli o denga manu i hongga taadeu henua.
 life GEN.O DET.PL organism PREP top DET.1PL.INCL.GEN island
 ‘You say, We are going to bring back the life of the plants of our island.’

- (36) Aagai ga hulo naa huu goodou ga loo-adu gai gu dige mai a
 then PRSP go.PL IRR when 2PL PRSP come.PL-DIR.MED so INC roll DIR.PROX PN
 Limango.
 Limango
 ‘So as you continue sailing out, Limango will roll in.’
- (37) Aagai ga dige mai naa huu a Limango, aagai ia ga daa mai de
 then PRSP rotate DIR.PROX IRR when PN Limango then 3SG PRSP beat DIR.PROX DET
 gau i mua, ga humai ai.
 people PREP front PRSP come.SG OBL
 ‘And as Limango rolls in, he will start killing the people in the front of the canoe and
 proceed back.’
- (38) Aagai ga tai madohi mai huu, gai koe ga hanadu laa mua, gai
 then PRSP almost halfway DIR.PROX when then 2SG PRSP go.SG-DIR.MED DIST front then
 koe ga gamai ga hhao ange gi te moni, aagai koe ga gabi
 2SG PRSP bring PRSP fill DIR.DIST to inside.DET canoe then 2SG PRSP hold.between
 ange.
 DIR.DIST
 ‘And when he gets about halfway, you go up before everyone and you take him and put
 him in the canoe, and grab him tightly between your legs.’
- (39) Gai ga gabi ange naa huu goe, gai ia ga hai adu,
 then PRSP hold.between DIR.DIST IRR when 2SG then 3SG PRSP say DIR.MED
 ‘And while you are grabbing him between your legs, he will ask you,’
- (40) Go ai de-nei?
 COP.FOC who DET-PROX
 ‘Who are you?’
- (41) Gai koe ga hai ange,
 then 2SG PRSP say DIR.DIST
 ‘And you’ll say,’
- (42) Go au go Tailalahaodengadubua.
 COP.FOC 1SG COP.FOC Tailalahaodengadubua
 ‘I am Tailalahaodengadubua.’

- (43) Gai ia ga hai adu naa,
 then 3SG PRSP say DIR.MED IRR
 'And he will say,'
- (44) Au ga sano.
 1SG PRSP give.up
 'I surrender.'
- (45) Gai koe ga hagabudu ono mana, ga kave.
 then 2SG PRSP gather 3SG.GEN.O power PRSP take
 'And you will collect his force, and take it.'
- (46) Aagai ga loo-adu ange naa huu goodou, gai tabula, e lui
 then PRSP come.PL-DIR.MED DIR.DIST IRR when 2PL then DET.lizard IPFV lay.across
 hagalooloa i mada i mua o d-oodou moni.
 CAUS-long PREP face PREP front GEN.O DET-2PL.GEN canoe
 'So as you continue to sail out, a lizard will lay across your path in front of your canoe.'
- (47) Gai koe ga hidi adu, ga hai togo ga hagaili ai i hongga ssugi.
 then 2SG PRSP get.up DIR.MED PRSP do DET.punt PRSP slap OBL PREP top DET.tail
 'So you will get up and take the canoe pole and strike him on the tail.'
- (48) Gai ga hagaili-a ina naa huu e goe, gai ia ga langa ssugi gi lungga.
 then PRSP slap-CIA INA MED when ERG 2SG then 3SG PRSP lift DET.tail to above
 'And when you strike it, he will lift his tail up.'
- (49) Gai ga langaa ina naa huu e goe, aagai goe ga langaa ina naa huu e ia,
 then PRSP lift.CIA INA IRR when ERG 2SG then 2SG PRSP lift.CIA INA IRR when ERG 3SG
 aagai koe ga ulu laa lalo d-ono sugi ga hano ai gi de baasi laa.
 then 2SG PRSP enter DIST below DET-3SG.GEN tail PRSP go.SG OBL to DET side PROX
 'And when you lift it, I mean, when it lifts up its tail, you will go under his tail to go to
 the other side.'
- (50) Aagai ga ui naa huu e goe, gai ia ga hai adu, Go ai de-nei?
 then PRSP pass IRR when ERG 2SG then 3SG PRSP say DIR.MED COP.FOC who DET-PROX
 'And when you pass under it, he will ask you, Who are you?'

- (51) Gai koe ga hai ange, Go au go Tailahalahaodengadubua.
 then 2SG PRSP say DIR.DIST COP.FOC 1SG COP.FOC Tailahalahaodengadubua
 ‘And you’ll say, I am Tailahalahaodengadubua.’
- (52) Gai ia ga hai adu, Au ga sano.
 then 3SG PRSP say DIR.MED 1SG PRSP give.up
 ‘And he will say to you, I surrender.’
- (53) Gai koe ga hagabudu hogi ono mana ga kave.
 then 2SG PRSP collect also 3SG.GEN.O power PRSP take
 ‘So you will collect his power too and take it.’
- (54) Gai ga loo-adu ange naa huu goodou, gai de baasua e hhang
 then PRSP come.PL-DIR.MED DIR.DIST IRR when 2PL then DET clam.sp IPFV open.up
 de ngudu, ma e baa tuu laa i de baasi langi i dai, gai tuu laa i
 DET mouth and IPFV touch cut DIST PREP DET side sky PREP east then cut DIST PREP
 de baasi langi i dua.
 DET side sky PREP west
 ‘So as you continue to sail out, a clam will open its mouth, and half of it will touch the
 eastern sky and the other half will touch the western sky.’
- (55) Gai koe ga hai togo ga velo ai lote ngudu.
 then 3SG PRSP do DET.pole PRSP pierce OBL inside.DET mouth
 ‘So you will take the canoe pole and poke it into his mouth.’
- (56) Gai ga velo-sia ina naa huu e goe, gai ia ga hagapuni ange, gai
 then PRSP pierce-CIA INA MED when ERG 2SG then 3SG PRSP join DIR.DIST then
 goodou ga hulo gi de baasi laa.
 3PL PRSP go.PL to DET side DIST
 ‘And as soon as you poke it, he will snap shut and you will go to the other side.’
- (57) Gai ia ga ssili age naa hogi,
 then 3SG PRSP ask up IRR also
 ‘And he will also ask,’
- (58) Go ai de-nei?
 COP.FOC who DET-PROX
 ‘Who are you?’

- (59) Gai koe ga hai ange, Go au go Tailahalahaodengadubua.
 then 2SG PRSP say DIR.DIST COP.FOC 1SG COP.FOC Tailahalahaodengadubua
 ‘And you will say, I am Tailahalahaodengadubua.’
- (60) Gai ia ga hai adu, Au ga sano.
 then 3SG PRSP say DIR.MED 1SG PRSP give.up
 ‘And he will say to you, I surrender.’
- (61) Gai koe ga hagabudu hogi ono mana ga kave.
 then 3SG PRSP collect also 3SG.GEN.O power PRSP take
 ‘And you will collect his power too and take it.’
- (62) Gai ga loo-adu ange naa huu goodou, gai gu baa mai tangada
 then PRSP come.PL-to2 DIR.DIST IRR when 2PL then INC near DIR.PROX DET.person
 iai de galauna.
 exist DET fishing.net
 ‘So as you continue to sail out, a person with the fishing net will become closer to you.’
- (63) Gai ia ga... ga dau naa huu d-oodou moni i de galauna, gai ia
 then 3SG PRSP PRSP reach IRR when DET-2PL.GEN canoe PREP DET fishing.net then 3SG
 ga hhudi goodou.
 PRSP pull.in 2PL
 ‘And he will... and when your canoe hits the net, he will pull you in.’
- (64) Gai ga huudia huu e ia gai koe ga hhudi hogi
 then PRSP pull.in.CIA when ERG 3SG then 2SG PRSP pull.in also
 ‘And when he pulls, you pull him also.’
- (65) ga hagabudu mai de galauna ga dugu i hongade moni.
 PRSP collect DIR.PROX DET fishing.net PRSP put PREP top DET canoe
 ‘and gather in the fishing net and put it on the canoe.’

- (66) Gai ga lagolago naa huu au galauna ne mau mai gi hongga
 then PRSP plenty IRR when 2SG.GEN.A fishing.net PFV be.able DIR.PROX to top
 d-oodou moni, aagai ga tae adu naa huu goodou, gai koe ga hai de
 DET-2PL.GEN canoe then PRSP arrive.PL DIR.MED IRR when 2PL then 3SG PRSP do DET
 galauna, ga buulou ai.
 fishing.net PRSP catch OBL
 ‘And when you are able to put much of the net on your canoe, and when you reach him,
 you’ll take the fishing net and catch him.’
- (67) Gai ia ga ssili adu naa,
 then 3SG PRSP ask DIR.MED IRR
 ‘And he will ask you,’
- (68) Go ai de-nei?
 COP.FOC who DET-PROX
 ‘Who are you?’
- (69) Gai koe ga hai ange,
 then 3SG PRSP say DIR.DIST
 ‘And you will say,’
- (70) Go au go Tailahalahaodengadubua.
 COP.FOC 2SG COP.FOC Tailahalahaodengadubua
 ‘I am Tailahalahaodengadubua.’
- (71) Gai ia ga hai adu naa.
 so 3SG PRSP say DIR.MED IRR
 ‘And he will say to you,’
- (72) Au ga sano.
 1SG PRSP give.up
 ‘I surrender.’
- (73) Gai koe ga hagabudu ono mana ga kave.
 then 3SG PRSP collect 3SG.GEN.O power PRSP take
 ‘And you will collect his power and take it.’

- (74) Gai gu tae ai loo goodou gi de henua.
 then INC reach.PL OBL EMPH 2PL to DET island
 ‘Then you will reach the island.’
- (75) Gai ga kage age naa huu goodou gi uda, gai koe gu gidee, Duuvaedahi, e
 then PRSP climb.PL up IRR when 2PL to inland then 2SG INC see Duuvaedahi IPFV
 duu ma e daohi de baasi langi i ngaage.
 stand and IPFV hold DET side sky PREP south
 ‘And when you go up on land, you will find Duuvaedahi standing and holding the south-
 ern sky.’
- (76) Aagai koe ga haga-daudau ia ga hagaili d-ono vae gi bigo, aagai koe
 then 2SG PRSP CAUS-wrestle 3SG PRSP strike DET-3SG.GEN.O leg SBJV bend then 2SG
 ga daohi age de baasi langi gi lunga.
 PRSP hold up DET side sky to above
 ‘And you will wrestle him and strike his leg so it buckles, and then you will hold up the
 sky.’
- (77) Aagai ia ga ssili adu naa, Go ai de-nei?
 then 3SG PRSP ask DIR.MED MED COP.FOC OBL DET-PROX
 ‘And he will ask you, Who are you?’
- (78) Gai koe ga hai ange,
 then 2SG PRSP say DIR.DIST
 ‘And you will say,’
- (79) Go au go Tailalahaodengadubua.
 COP.FOC 1SG COP.FOC Tailalahaodengadubua
 ‘I am Tailalahaodengadubua.’
- (80) Gai ia ga hai adu naa, Au ga sano.
 then 3SG PRSP say DIR.MED IRR 1SG PRSP give.up
 ‘And he will say to you, I surrender.’

- (81) Gai koe ga hagabudu ono mana ga kave, gai muli mai naa huu
 then 2SG PRSP collect 3SG.GEN.O power PRSP take then behind DIR.PROX IRR when
 d-oo sauua ne kave nei i daho tangada Duuvaedahi, aagai koe
 DET-2SG.GEN.O power PFV take PROX PREP place.GEN DET.person Duuvaedahi then 2SG
 ga haga-ingoo ange bolo koe go Daula.
 PRSP CAUS-name DIR.DIST COMP 2SG COP.FOC Daula
 ‘So you will collect his power and take it, and after you take the power from the man
 named Duuvaedahi, then you will name yourself Daula.’
- (82) Aagai koe ga hano nei loo e haga-ahe mai mouli o dengaa
 then 2SG PRSP go.SG PROX EMPH IPFV CAUS-return DIR.PROX life GEN.O DET.PL.SUP
 manu.
 organism
 ‘So you are now going to bring back the life of the plants.’
- (83) Gai koe ga dugu, d-oo soa tama hodoologi i dahi mommee.
 then 2SG PRSP put DET-2SG.GEN.O friend DET.child chief PREP one place
 ‘And you will put your friend, the young prince, somewhere.’
- (84) Gai koe ga hai ange de mee haga-lilo, henua, ga haga-lilo ai, gi
 then 2SG PRSP do DIR.DIST DET thing CAUS-disappear island PRSP CAUS-disappear OBL to
 dee gidee ai e dangada, e nnoho laa i kilaa, kana gai-na ia.
 NEG see OBL ERG person IPFV live.PL DIST PREP there lest eat-CIA 3SG
 ‘Then you will make a cover for the island, and cover the island with it, so that you can’t
 be found by anyone that lives nearby, otherwise they would eat him.’
- (85) Gai koe ga hano.
 then 2SG PRSP go.SG
 ‘Then you will go.’
- (86) Ga hanadu naa huu goe, gai e kona donu de haga-vvela de momme o
 PRSP go.SG-up IRR when 2SG then IPFV much EMPH DET CAUS-hot DET place GEN.O
 denga hitegaiaa, e sigosigo ai laa i mouli o dengaa manu.
 DET.PL demon IPFV catch.RED OBL DIST PREP life GEN.O DET.PL.SUP organism
 ‘When you go, the place will be very hot, where the *hitegaiaa* are throwing and catching
 the life of the plants.’

- (87) Gai koe ga hai-a... gai koe ga han-adu naa huu, gai koe ga ulu gi olaadeu
 then 2SG PRSP do-CIA then 2SG PRSP go.SG-up IRR when then 2SG PRSP enter to 3PL.GEN.O
 daha, gai koe ga sigosigo.
 place then 2SG PRSP catch.RED
 ‘So when you... so when you go there, you will go inside where they are, and you will
 throw and catch with them.’
- (88) Gai ga sigosigo naa huu goe, gu dae mai de masavaa e dau ai
 then PRSP catch.RED IRR when 2SG INC reach DIR.PROX DET time IPFV arrive OBL
 dangada gai koe ga hai go koe e dau-lia.
 person then 2SG PRSP do COP.FOC 2SG IPFV read-CIA
 ‘And as you are throwing and catching, it will come time to chant the names of people,
 and you will be the one to chant them.’
- (89) Gi dee iloo ai e gilaadeu, bolo dahi dangada gu ulu ange gi olaadeu
 SBJV NEG know OBL ERG 3PL COMP one person INC enter DIR.DIST to 3PL.GEN.O
 masavaa.
 midst
 ‘And they won’t know that someone has entered into their midst.’
- (90) Gai ga haga-dige huu goodou gu dae mai de hidu hanonga, gai koe ga
 then PRSP CAUS-roll when 2PL INC reach DIR.PROX DET seven iteration then 2SG PRSP
 hhao de hua bonga gi lot-oo malo huna.
 put.inside DET fruit defective to inside.DET-2SG.GEN loincloth
 ‘So as you all go around the seventh time, you will put the defective fruit inside your
 loincloth.’
- (91) Gai ga daamada ange huu de dau, gai koe ga dau hogi.
 then PRSP begin DIR.DIST when DET read/chant then 2SG PRSP read/chant also
 ‘And when the chanting begins again, then you will chant also.’
- (92) Gai ga hagadige mai huu gu dae mai de mada baabaa, gai koe ga
 then PRSP CAUS-roll DIR.PROX when INC reach DIR.PROX DET face flat then 2SG PRSP
 hhao gi lot-oo malo huna.
 put.in to inside.DET-2SG.GEN.O loincloth
 ‘And when it comes around to you and the *mada baabaa* reaches you, you will put it inside
 your loincloth.’

- (93) Gai ga lava huu i dau hhao mee nei, gai koe ga
 then PRSP finish when PREP DET-2SG.GEN.A put.inside thing PROX so 2SG PRSP
 haga-lilo, gai koe ga ahe mai ai loo.
 CAUS-disappear then 2SG PRSP return DIR.PROX OBL EMPH
 ‘And after you have finished putting these things inside, you will disappear and return
 back.’
- (94) Gai tama laa, ga hai ai loo gi bei muna, a d-ono damana ne
 then DET.child DIST PRSP do OBL EMPH to like word GEN.A DET-3SG.GEN.O father PFV
 tala ange.
 tell DIR.DIST
 ‘So that child did as his father had told him.’
- (95) Gai ia ga humai, ga gaa-mai d-ono soa go tama
 then 3SG PRSP come.SG PRSP bring-DIR.PROX DET-3SG.GEN.O friend COP.FOC DET.child
 a de hodooligi, ga loomai ai gilaau.
 GEN.A DET king PRSP come.PL OBL 3DU
 ‘He came, and brought his friend, the child of the king, and they came.’
- (96) Gai ga kage huu gilaau gi hongga de-laau moni, gai gilaau ga aahe
 then PRSP climb.PL when 3DU to top DET-3DU.GEN canoe then 3DU PRSP return.PL
 mai, ga dele mai ai loo gi de-laau henua go Nuguolo.
 DIR.PROX PRSP sail DIR.PROX OBL EMPH to DET-3DU.GEN island COP.FOC Nukuoro
 ‘And when they climbed onto their canoe, they returned, and sailed to their island of
 Nukuoro.’
- (97) Gai ga tae mai huu gilaau, gai gilaau ga doo
 then PRSP reach.PL DIR.PROX when 3DU then 3DU PRSP drop
 ‘When they arrived, they planted’
- (98) de mada baabaa, ma de hua bongga.
 DET face flat and DET fruit defective
 ‘the *mada baabaa* and the defective fruit.’

- (99) Gai ga doo ina huu e gilaau, gai gu aahe age hongade henua ma gu
 then PRSP drop INA when ERG 3DU then INC return.PL up top DET island and INC
 hhua ma gu mmili.
 bear.fruit.PL and INC plentiful
 ‘And when they planted them, the spirits of the plants returned to the land and the plants
 bore fruit and were plentiful.’
- (100) Denga gau looloa nui denga nui i luu baasi de ava, i
 DET.PL fruit.bunch coconut.tree DET.PL coconut.tree PREP DET.DU side DET channel PREP
 Gausema, gu daudau iho hugadoo denga gau looloa gi lalo.
 Gausema INC hang.RED down above.all DET.PL fruit.bunch to below
 ‘The coconut bunches, the coconut trees on each side of the channel, at Gausema, all the
 bunches hung down.’
- (101) Gai denga hitegaiaa ga nnoho nnoho huu, gai gilaadeu ga maanadu age bolo
 then DET.PL demon PRSP live.PL live.PL when then 3PL PRSP think up COMP
 gu maakau naa loo de gau Nuguolo.
 INC die.PL IRR EMPH DET people Nukuoro
 ‘And as the hitegaiaa stayed and stayed, they thought that the people of Nukuoro were
 all dead.’
- (102) Gu deai donu dangada go hidinga gu deai donu mee e gai.
 INC no EMPH person COP.FOC reason INC no EMPH thing IPFV eat
 ‘There were no more people because there was nothing to eat.’
- (103) Gai gilaadeu ga loomai bolo e tilo delaadeu henua go Nuguolo.
 then 3PL PRSP come.PL COMP IPFV look.at DET-3PL.GEN island COP.FOC Nukuoro
 ‘So they came to visit their island, Nukuoro.’
- (104) Gai ga loomai huu gilaadeu, ga ssula mai i mate ava, gai
 then PRSP come.PL when 3PL PRSP appear.PL DIR.PROX PREP front.DET channel then
 gilaadeu gu gidee, denga gau looloa huaa mee gu llui iho hugadoo gi lalo
 3PL INC see DET.PL fruit.bunch young.coconut INC turn.PL down above.all to below
 ma gu daakodo ai gai gilaadeu ga hagataba,
 and INC lay.PL OBL then 3PL PRSP say
 ‘So when they came, and appeared in front of the channel, they saw that the bunches of
 fruit were hanging down the way they were, and they said,’

- (105) Ee laa, gu dae mai loo dahi daane sauua gi gilaadeu, kii ange
 wow INC reach DIR.PROX EMPH one man power to 3PL increase DIR.DIST
 d-ono sauua.
 DET-3SG.GEN.O power
 ‘Oh, a powerful man has reached them, whose power is very great.’
- (106) Gu haga-ahe age mouli o denga manu delaadeu henua.
 INC CAUS-return up life GEN.O DET.PL organism DET-3PL.GEN island
 ‘He brought back the life of the plants of their island.’
- (107) Gai gilaadeu, ga aahe adu huu, gai gilaadeu ga ... gai a Limango ga
 then 3PL PRSP return.PL DIR.MED when then 3PL PRSP so PN Limango PRSP
 hai ange,
 say DIR.DIST
 ‘So when they returned, they... Limango said.’
- (108) E dahi dangada ne humai.
 IPFV one person PFV come.SG
 ‘Someone came.’
- (109) Gai ia ga ... gai au ga dige adu laa hongatai, gai ia ga hhao
 then 3SG PRSP then 1SG PRSP roll DIR.MED DIST top DET.sea then 3SG PRSP put.inside
 ange au gi lote moni, gai ia ga baalasi ange luu oa de
 DIR.DIST 1SG to inside.DET canoe then 3SG PRSP sit.on DIR.DIST DET.DU gunwale DET
 moni.
 canoe
 ‘And he... And I was rolling on top of the sea, and he put me inside the canoe, and he
 pressed me against the two gunwales of the canoe.’
- (110) Gai au ga hai ange, Go ai de-nei?
 then 1SG PRSP say DIR.DIST COP.FOC who DET-PROX
 ‘And I said, Who are you?’
- (111) Gai ia ga hai mai, Go au go Tailahalahaodengadubua.
 then 3SG PRSP say DIR.PROX COP.FOC 1SG COP.FOC Tailahalahaodengadubua
 ‘And he said, I am Tailahalahaodengadubua.’
- (112) Gai ia ga hagabudu ugu mahi ga kave.
 then 3SG PRSP collect 1SG.GEN.O strength PRSP take
 ‘And he collected my strength and took it.’

- (113) Ga lava gai ia ga... gai tabula ga hai ange,
PRSP finish then 3SG PRSP then DET.lizard PRSP say DIR.DIST
'And then, he... then the lizard said,'
- (114) E dahi dangada, gu hagaili hogi d-ogu sugi.
IPFV one person INC strike also DET-1SG.GEN.O tail
'There was a man who also struck my tail.'
- (115) Aagai au ga ssili ange, Go ai de-nei?
then 1SG PRSP ask DIR.DIST COP.FOC who DET-PROX
'So I asked, Who are you?'
- (116) Gai ia ga hai mai, Go au go Tailalahaodengadubua.
then 3SG PRSP say DIR.PROX COP.FOC 1SG COP.FOC Tailalahaodengadubua
'And he said, I am Tailalahaodengadubua.'
- (117) Gai ia ga hagabudu hogi ogu mahi ga kave.
then 3SG PRSP collect also 1SG.GEN.O strength PRSP take
'And he also collected my strength and took it.'
- (118) Aagai de baasua ga hai ange,
then DET clam PRSP say DIR.DIST
'And the clam said,'
- (119) Dahi dangada, gu lava hogi i de velo i lot-ogu ngudu.
one person INC finish also PREP DET pierce PREP inside.DET-1SG.GEN.O mouth
'A man had also stabbed me inside my mouth.'
- (120) Gai au ga ssili ange ga hai ange, Go ai de-nei?
then 1SG PRSP ask DIR.DIST PRSP say DIR.DIST COP.FOC who DET-PROX
'So I asked him, saying, Who is this?'
- (121) Gai ia ga hai mai, Go au go Tailalahaodengadubua.
then 3SG PRSP say DIR.PROX COP.FOC 1SG COP.FOC Tailalahaodengadubua
'And he said to me, I am Tailalahaodengadubua.'

- (122) Gai ia ga kave hogi ogu mahi.
 then 3SG PRSP take also 1SG.GEN.O strength
 ‘And he... he took my strength as well.’
- (123) Gai ia, gai tangada iai de galauna ga hai ange,
 then 3SG then DET.person have DET fishing.net PRSP say DIR.DIST
 ‘So he, the person who had the fishing net said,’
- (124) Au ne dau hogi dahi mee i lot-agu galauna, gai au ga
 1SG PFV arrive also one thing PREP inside.DET-1SG.GEN.A fishing.net then 1SG PRSP
 hhudi mai, gai tangada i hongade moni, gai ia ga buulou au i
 pull DIR.PROX then DET.person PREP top DET canoe then 3SG PRSP catch 1SG PREP
 dagu galauna.
 DET-1SG.GEN.A fishing.net
 ‘I caught something in my net, so I pulled it in, but the person on the canoe, he caught me
 in my net.’
- (125) Gai au gu tai magau donu.
 then 1SG INC almost die EMPH
 ‘And I almost died.’
- (126) Gai au ga ssili ange ga hai ange, Go ai de-nei?
 then 1SG PRSP ask DIR.DIST PRSP say DIR.DIST COP.FOC who DET-PROX
 ‘So I asked and said, Who are you?’
- (127) Gai ia ga hai mai, Go au go Tailalahaodengadubua.
 then 3SG PRSP say DIR.PROX COP.FOC 1SG COP.FOC Tailalahaodengadubua
 ‘And he said, I am Tailalahaodengadubua.’
- (128) Gai ia ga hagabudu hogi ogu sauua ga kave.
 then 3SG PRSP collected also 1SG.GEN power PRSP take
 ‘And he collected my power too and took it.’
- (129) Gai tangada duu vae dahi ga hai ange bolo, Dahi dangada ne humai hogi
 then DET.person stand leg one PRSP say DIR.DIST COMP one person PFV come.SG also
 ga hagaili dogu vae, gai au ga baguu gai de baasi langi gu doo iho.
 PRSP strike DET-1SG.GEN.O leg then 1SG PRSP fall then DET side sky INC drop down
 ‘And the man standing on one leg said, A man came to me too and struck my leg, and I
 fell, and half of the sky fell down.’

- (130) Gai au ga ssili ange, Go ai de-nei?
 then 1SG PRSP ask DIR.DIST COP.FOC who DET-PROX
 ‘So I asked, Who are you?’
- (131) Gai ia ga hai mai, Go au go Tailalahaodengadubua.
 then 3SG PRSP say DIR.PROX COP.FOC 1SG COP.FOC Tailalahaodengadubua
 ‘And he said to me, I am Tailalahaodengadubua.’
- (132) Gai ia ga hagabudu hogi ogu mahi ga kave.
 then 3SG PRSP collect also 3SG.GEN.O strength PRSP take
 ‘And he collected my strength too and took it.’
- (133) Gai ga lava huu i dana kave mee nei, maanadu, gai ia gu
 then PRSP finish when PREP DET-3SG.GEN.A take thing PROX think then 3SG INC
 han-adu ai donu gi oodou daha.
 go.SG-DIR.MED OBL EMPH to 2PL.GEN place
 ‘And when he was finished taking these things, I think he went over to you all.’
- (134) Gai de-naa ai, go ia donu ne han-adu naa ga haga-ahe-a
 then DET-MED OBL COP.FOC 3SG EMPH PFV go.SG-DIR.MED MED PRSP CAUS-return-CIA
 mai, mouli o dengaa manu, o Nuguolo.
 DIR.PROX life GEN.O DET.PL.SUP organism GEN.O Nukuoro
 ‘And so, it was him who came and returned the life of all the plants of Nukuoro.’
- (135) Ga gaav-age gi Nuguolo.
 PRSP bring-up to Nukuoro
 ‘And brought them to Nukuoro.’
- (136) D-ono ingoo, go Tailalahaodengadubua.
 DET-3SG.GEN.O name COP.FOC Tailalahaodengadubua
 ‘His name is Tailalahaodengadubua.’
- (137) Gai gilaadeu ga pasa ai, gai gilaadeu ga maanadu age bolo, tangada nei,
 then 3PL PRSP talk.PL OBL then 3PL PRSP think up COMP DET.person PROX
 dagu maanadu huu, gu sauaa ange i gidaadeu alodahi.
 DET-1SG.GEN.A think when INC power DIR.DIST PREP 1PL.INCL all
 ‘So they talked about it, and they thought, this man, I think, is more powerful than all of us.’

- (138) Ia gu maua i de hagadubudubu ange gi denga bouli gee.
 3SG INC be.able PREP DET transfigure DIR.DIST to DET.PL spiritual.form different
 ‘He can turn himself into different forms.’
- (139) De-nei ai ana gu mau ai nei i de humai.
 DET-PROX OBL 3SG.GEN.A INC be.able OBL PROX PREP DET come.SG
 ‘So this is how he was able to come.’
- (140) Dangada alodahi ne loomai laa, i denga hanonga gu hulo laa, teai donu
 person all PFV come.PL DIST PREP DET.PL iteration INC go.PL DIST PFV.NO EMPH
 se dangada ne maua i de hu-mai.
 COP.SG person PFV be.able PREP DET come.SG-DIR.PROX
 ‘All the people who came in the past, none of them were able to make it in.’
- (141) Aagai go ia donu huu ne maua i de humai, ga dae mai gi
 then COP.FOC 3SG only PFV be.able PREP DET come.SG PRSP reach DIR.PROX to
 i kinei, ga haga-ahe age ai mouli o dengaa manu, ga mouli ai
 PREP here PRSP CAUS-return up OBL life GEN.O DET.PL.SUP organism PRSP alive OBL
 delaadeu henua go Nuguolo.
 DET-3PL.GEN island COP.FOC Nukuoro
 ‘It was only him that was able to come and reach here, and return the life of the plants,
 and bring their island of Nukuoro back to life.’
- (142) De-nei ai iainei, gidaadeu gu dee iloo de loo-age, gu deai
 DET-PROX OBL right.now 1PL.INCL INC NEG know DET come.PL-up INC no
 se-daadeu henua.
 COP.SG-1PL.INCL.GEN island
 ‘And so now, we cannot go back, it’s not our island anymore.’
- (143) Gilaadeu, e mouli ma e nnoho i hongaga de-laadeu henua, gai gidaadeu ga
 3PL IPFV live and IPFV sit.PL PREP top DET-3PL.GEN island then 1PL.INCL PRSP
 nnoho ai donu huu i hongaga taadeu henua, gai gilaadeu, ga nnoho i
 sit.PL OBL only PREP top DET.1PL.INCL island then 3PL PRSP sit.PL PREP
 de-laadeu henua.
 DET-3PL.GEN island
 ‘They are alive and living on their island, so we will stay on our island, and they will stay
 on their island.’

- (144) Gai dua huu mee nei, gai gu magau ai loo tamana o
 then back when thing PROX then INC die OBL EMPH DET.father GEN.O
 Tailalahaodengadubua.
 Tailalahaodengadubua
 ‘So after this, Tailalahaodengadubua’s father died.’
- (145) Aagai Tailalahaodengadubua, go ia ai loo gu sula, ma gu noho i
 then Tailalahaodengadubua COP.FOC 3SG OBL EMPH INC succeed and INC live PREP
 hongtaadeu henua, ma gu tilo ange ai, gu odi ai loo, agu
 top DET.1PL.INCL island and INC look DIR.DIST OBL INC empty OBL EMPH 1SG.GEN
 momo me e iloo.
 few thing IPFV know
 ‘So Tailalahaodengadubua, he succeeded and stayed on their island, and looked after it.
 And this is it, the few things that I know.’

A.4 Taalanga o Dabedoo (11-2) – Lina

Speaker: Lina

Date recorded: Spring 1966

Location: Nukuoro Atoll, Pohnpei State, Federated States of Micronesia

Recording information: Reel 11, story 2

Lina tells the story of Daabedoo, a ghost who scares a woman while she is sleeping. A benevolent spirit named Iaigausema stops Dabedoo, who claims that the goddess Dehinealigi commanded him to do it.

- (1) Iaigausema d-ono momme hagamabu
 Iaigausema DET-3SG.GEN.O place rest
 ‘The place where Iaigausema went to relax’
- (2) go lote ava i baasi i dua Boonibei,
 COP.FOC inside.DET channel PREP side PREP back Pohnpei
 ‘was inside the channel at the eastern side of Pohnpei,’
- (3) go de ava o Madalanim. Ia e dagodo ai i dahi boo.
 COP.FOC DET channel GEN.O Madolenihmw 3SG IPFV lay OBL PREP one night
 ‘The channel at Madolenihmw. He was laying there one night.’

- (4) Gai dahi haahine ma d-ono bodu ne hulo e haangoda d-ono
 then one woman and DET-3SG.GEN.O spouse PFV go.PL IPFV fish DET-3SG.GEN.O
 bodu i Moduilalo.
 spouse PREP Moduilalo
 'So one woman and her husband went so that her husband could fish at Moduilalo.'
- (5) Gai de hine laa e seni sogosogo. Gai Dabedoo ga hu-mai.
 then DET woman DIST IPFV sleep alone then Dabedoo PRSP come.SG-DIR.PROX
 'So the woman fell asleep alone. Then Dabedoo came.'
- (6) Ga hhanganga anged-ono aloalo ga haga-too iho mee i
 PRSP split.open DIR.DIST DET-3SG.GEN.O side.of.body PRSP CAUS-fall.PL down thing PREP
 ono lodo, gi hongalu mada o de hine laa.
 3SG.GEN.O inside to top DET.DU face GEN.O DET woman DIST
 'He split open his side and made his organs fall out onto the woman's face.'
- (7) Gai de hine laa gu kona donu de madagu.
 then DET woman DIST INC very EMPH DET afraid
 'And the woman became very afraid.'
- (8) Ia gu dai dee iloo donu i de basa.
 3SG INC almost NEG know EMPH PREP DET talk
 'She almost couldn't speak.'
- (9) Gai ia ga basa i d-ono leo musumusuga hagaagahi,
 then 3SG PRSP talk PREP DET-3SG.GEN.O voice whisper PRSP call
 'So she spoke in a whisper and called out.'
- (10) I hee iai nei tangada ni-oona denga gano agau nei?
 PREP where now DET.person COP.PL-3SG.GEN.O DET.PL ?? reef PROX
 'Where is the person who rules these islets?'
- (11) Au ga magau nei donu.
 1SG PRSP die PROX EMPH
 'I am about to die.'
- (12) Gai Iaigausema, gu langona e ia ssugi de leo o de hine nei.
 then Iaigausema INC hear ERG 3SG DET.tail DET voice GEN.O DET woman PROX
 'And Iaigausema, he heard the echo of the voice of this woman.'

- (13) Gai ia ga hidi age ga humai, gi moolau.
 then 3SG PRSP stand up PRSP come.SG SBJV quick
 ‘So he stood up and came immediately.’
- (14) Gai ga humai huu e ia gu gidee e ia Dabedoo e hai be laa de
 then PRSP come.SG when ERG 3SG INC see ERG 3SG Dabedoo IPFV do like DIST DET
 hine laa.
 woman DIST
 ‘And when he came, he saw Dabedoo doing that to that woman.’
- (15) Gai ia ga poo Dabedoo ga maga gi lausedi.
 then 3SG PRSP grab Dabedoo PRSP throw to salt.water
 ‘So he grabbed Dabedoo and threw him into the water.’
- (16) Gai ia ga hai ange, Hannoo donu iai nei.
 then 3SG PRSP say DIR.DIST leave EMPH now
 ‘And he scolded him, Leave right now.’
- (17) Au kana dagahi ange goe gi buni ange gi denga gano agau i kinei.
 1SG lest step.on DIR.DIST 2SG SBJV join DIR.DIST to DET.PL reef.and.land PREP here
 ‘Otherwise I will crush you with my foot and you will become part of the land here.’
- (18) Agai Dabedoo ga dangidangi ange gi de ia ga hai ange,
 then Dabedoo PRSP cry.RED DIR.DIST to DET 3SG PRSP say DIR.DIST
 ‘So Dabedoo apologized to him and said,’
- (19) Aude haihai-a. E dee go au donu e lodo e hai-a mee nei.
 NEG.IMP do.RED-CIA IPFV NEG COP.FOC 1SG EMPH IPFV want IPFV do-CIA thing PROX
 ‘I am sorry. It wasn’t really me who wanted to do this.’
- (20) Gai go Dehinealigi e hai mai au e haga-ago-na, e haga-ago-na
 then COP.FOC Dehinealigi IPFV make DIR.PROX 1SG IPFV CAUS-learn-CIA IPFV CAUS-learn-CIA
 ngau gi hai-a.
 1SG SBJV do-CIA
 ‘It was Dehinealigi who made me, who commanded me to do this.’
- (21) Aa-naa ai donu huu agu momo mee e iloo.
 PL-MED OBL only 1SG.GEN.A few thing IPFV know
 ‘These are the few things that I know.’

A.5 Taalanga o Iaidelangi (11-3) — Otto

Speaker: Otto

Date recorded: Spring 1966

Location: Nukuoro Atoll, Pohnpei State, Federated States of Micronesia

Recording information: Reel 11, story 3

Otto tells the story of Iaidelangi, who spawned twelve generations of children from his sweat.

- (1) Iaidelangi, e hai d-ana veelenga.
Iaidelangi IPFV do DET-3SG.GEN.A garden
'Iaidelangi was tending his garden.'
- (2) Aagai e mahana de mee. E dii de laa.
then IPFV hot DET thing IPFV shine DET sun
'It was hot. The sun was shining.'
- (3) Aagai ia ga sali-a e taadaa, d-ono angaanga.
then 3SG PRSP seep-CIA ERG DET.sweat DET-3SG.GEN.O body
'And his body began to sweat.'
- (4) Aagai ia ga hai tuu gaha, ga haga-mmasa ai ono daadaa.
then 3SG PRSP do DET.COCONUT.husk PRSP CAUS-dry OBL 3SG.GEN.O sweat
'So he used a coconut husk to dry his sweat.'
- (5) Aagai ga haga-mmasa huu ono daadaa i tuu gaha, aagai de hine,
then PRSP CAUS-dry when 3SG.GEN.O sweat PREP DET.COCONUT.husk then DET woman
ga humai ga han-ange gi agina.
PRSP come.SG PRSP go.SG-DIR.DIST to there
'When he dried his sweat with the coconut husk, a woman came and went over to him.'
- (6) Ga han-ange gi tuu gaha. Agai ia gu hai dama.
PRSP go.SG-DIR.DIST to DET.COCONUT.husk then 3SG INC make child
'She went over to the coconut husk. And she became pregnant.'
- (7) D-ono hai dama i mua, e dino-angahulu ana dama.
DET-3SG.GEN.O make child PREP front IPFV CL.HUM-ten 3SG.GEN.A child
'Her first pregnancy, she had ten children.'

- (8) De-nei de ingoo o ana dama. Go Mauidaha, go Mauilodo,
 DET-PROX DET name GEN.O 3SG.GEN.A child COP.FOC Mauidaha COP.FOC Mauilodo
 go Moeaali, go Mueaali, go Moosonai, go Mosdama, go
 COP.FOC Moeaali COP.FOC Mueaali COP.FOC Moosonai COP.FOC Mosdama COP.FOC
 Dangulu, go Dangolo go Luhagausinga, go Tubuadeegagu.
 Dangulu COP.FOC Dangolo COP.FOC Luhagausinga COP.FOC Tubuadeegagu
 ‘These are the names of her children. Mauidaha, Mauilodo, Moeaali, Mueaali, Moosonai,
 Mosdama, Dangulu, Dangolo, Luhagausinga, and Tubuadeegagu.’
- (9) Aagai de lua hagadiili-nga, gai aa-nei ana dama.
 then DET two produce.offspring-NMLZ then PL-PROX 3SG.GEN.A child
 ‘And the second time she gave birth, these were her children.’
- (10) Gai ia ga haanau, go Degumi, go Deloha, go Delubu, go
 then 3SG PRSP give.birth COP.FOC Degumi COP.FOC Deloha COP.FOC Delubu COP.FOC
 Udaageno, go Buamageno, go Gaeageno, go Doogeno go Geno,
 Udaageno COP.FOC Buamageno COP.FOC Gaeageno COP.FOC Doogeno COP.FOC Geno
 go Dumulod.
 COP.FOC Dumulodo
 ‘She gave birth to Degumi, Deloha, Delubu, Udaageno, Buamageno, Gaeageno, Doogeno,
 Geno, and Dumulodo.’
- (11) Aagai tolu ono hagadiili-nga,
 then DET.three 3SG.GEN.O produce.offspring-NMLZ
 ‘The third time she gave birth,’
- (12) go Nansiilaane, go Nansiibung, go Mansiiban, Gubuleni,
 COP.FOC Nansiilaane COP.FOC Nansiibungu COP.FOC Mansiibana Gubuleni
 Gubulenibuleniallagae.
 Gubulenibuleniallagae
 ‘it was Nansiilaane, Nansiibungu, Mansiibana, Gubuleni, Gubulenibuleniallagae.’
- (13) Go Iiilisae. Go Ooolosae. Go Iilili. Go Naonao.
 COP.FOC Iiilisae COP.FOC Ooolosae COP.FOC Iilili COP.FOC Naonao
 ‘Iiilisae, Ooolosae, Iilili, Naonao.’

- (14) Go Meao. Aa-naa denga hagadiili-nga a daadaa o Iaidelangi,
 COP.FOC Meao PL-MED DET.PL produce.offspring-NMLZ GEN.A sweat GEN.O Iaidelangi
 aa-naa agu momo mee e longo ai, aa-naa mee agu e iloo, i
 PL-MED 1SG.GEN.A few thing IPFV hear OBL PL-MED thing 1SG.GEN IPFV know PREP
 mee o Iaidelangi.
 thing GEN.O Iaidelangi
 ‘And Meao. So, these are the pregnancies from the sweat of Iaidelangi, these are a few
 things that I heard, these are the things I know about Iaidelangi.’
- (15) Aagai e madaangahulu ma lua hagadiili-nga o ana dama,
 then IPFV ten and two produce.offspring-NMLZ GEN.O 3SG.GEN.A child
 ono daadaa.
 3SG.GEN.O sweat
 ‘There were twelve generations of his children, from his sweat.’
- (16) Aagai gu ngalo i de au hanu.
 then INC forget PREP DET 1SG some
 ‘I forget some of them.’
- (17) Gai aa-naa huu agu mee e iloo. Aa-naa ai huu. Gu lava.
 then PL-MED when 1SG.GEN thing IPFV know PL-MED OBL when INC finish
 ‘Those are the things that I know. That’s it, I’m finished.’

A.6 Iaidebaba (11-4) – Otto

Speaker: Otto

Date recorded: Spring 1966

Location: Nukuoro Atoll, Pohnpei State, Federated States of Micronesia

Recording information: Reel 11, story 4

Otto tells the story of Iaidebaba, who defeated a group of foreigners that had settled on the islet of Dahangadabu. When the foreigners were defeated, they swam into the water and drowned, and coral heads grew from their bodies in a line extending out toward the lagoon.

- (1) De masavaa nei gai au e damaa tala age hogi momo mee aagu e iloo
 DET time PROX then 1SG IPFV little tell up also few thing 1SG.GEN.A IPFV know
 i taalanga o Iaidebaba.
 PREP DET.story GEN.O Iaidebaba
 ‘Right now, I will talk a little bit about the few things that I know of the story of Iaidebaba.’

- (2) E dahi vaga henua gee
 IPFV one canoe island away
 'There was a foreign canoe'
- (3) ne dau i dua luu Dahanga.
 PFV arrive PREP back DET.DU Dahanga
 'that arrived on the ocean-side of the two Dahangas.'¹
- (4) Aagai denga gau mai vaga ga loo-iho ga nnoho i Dahangadabu.
 then DET.PL people DIR.PROX canoe PRSP come.PL-down PRSP live.PL PREP Dahangadabu
 'And the people from the canoe came down and stayed on Dahangadabu.'
- (5) Gai gilaadeu ga nnoho huu i Dahangadabu, gai gilaadeu ga helau de
 then 3PL PRSP live.PL when PREP Dahangadabu then 3PL PRSP bewitch DET
 gau i de henua gi dee iloo i de hulo gi modu.
 people PREP DET island SBJV NEG know PREP DET go.PL to islet
 'And when they stayed on Dahangadabu, they bewitched the people on the island so that
 they could not come to that islet.'
- (6) Gilaadeu ga nnoho i de modu laa ga helau mai ai laa dai denga
 3PL PRSP live.PL PREP DET islet DIST PRSP bewitch DIR.PROX OBL DIST lagoon DET.PL
 modu laa alodahi gu dagodo be se ahi laa.
 islet DIST all INC lay like COP.SG fire DIST
 'They stayed on that islet, and bewitched the lagoon-side of all those islands to seem like
 a fire.'
- (7) Gai dangada e hulo e hai alaadeu mee, ga dae-a adu huu luu
 then person IPFV go.PL IPFV do 3PL.GEN.A thing PRSP arrive-CIA DIR.MED when DET.DU
 modu nnui, gai gu dee maua i de hulo gi ngaiho.
 islet large then INC NEG be.able PREP DET go.PL to north
 'So when people came to do their work, when they reached those two islets, they couldn't
 go any further north.'
- (8) Gu mahana mai denga helau a denga gau mai vaga laa.
 INC hot DIR.PROX DET.PL bewitch GEN.A DET.PL people DIR.PROX canoe DIST
 'It was hot from the magic of the foreign people.'

¹This refers to two islets that are next to each other, Dahangadabu and Dahangahainoo.

- (9) Gai dangada ga aahe mai gi Hale.
 then person PRSP return.PL DIR.PROX to Hale
 'So people returned to the main islet.'
- (10) Ga lava gu dee iloo de hulo e hai mee a dangada gi de bido gi ngaiho,
 PRSP finish INC NEG know DET go.PL IPFV do thing GEN.A person to DET side to north
 'So, they did not know how to go to the north side to do their work.'
- (11) i denga modu i ngaiho.
 PREP DET.PL islet PREP north
 'to the northern islets.'
- (12) Ga lava gai denga eidu alodahi o Nuguolo ga loomai e hagatale de
 PRSP finish then DET.PL ghost all GEN.O Nukuoro PRSP come.PL IPFV try DET
 hulo e oha de mee laa.
 go.PL IPFV break DET thing DIST
 'Then, all the ghosts of Nukuoro came and tried to go and break that spell.'
- (13) Gai ga hulo hulo huu denga eidu e dee maua donu e gilaadeu.
 then PRSP go.PL go.PL when DET.PL ghost IPFV NEG be.able EMPH ERG 3PL
 'But the ghosts tried and tried, and they weren't able to do it.'
- (14) Ga lava ga hai ange Iaidebaba,
 PRSP finish PRSP say DIR.DIST Iaidebaba
 'Then, Iaidebaba said,'
- (15) Dugu-a mai gi de au gi hano agina.
 leave.CIA DIR.PROX to DET 1SG SBJV go.SG there
 'Allow me to go there.'
- (16) Gai gimaadeu ma ogu gau ga hulo nei agina.
 then 1PL.EXCL and 1SG.GEN.O people PRSP go.PL PROX to.there
 'Me and my people will go there.'
- (17) Ga lava gai gilaadeu ga hulo.
 PRSP finish then 3PL PRSP go.PL
 'And so, they went.'

- (18) Ga loo-adu huu gai ui adu gi ngaiho o Tuila, gai gu gidee
 PRSP come.PL-DIR.MED when then pass.over DIR.MED to north GEN.O Tuila then INC see
 mai e denga gau mai vaga i Dahanga, gu loo-adu loo.
 DIR.PROX ERG DET.PL people DIR.PROX canoe PREP Dahanga INC come.PL-DIR.MED EMPH
 ‘As they came and passed over the north side of Tuila, those foreigners on Dahanga saw
 them coming.’
- (19) Gai gilaadeu ga helau, ga haga-mmahi de helau ga gaa-mai.
 then 3PL PRSP do.magic PRSP CAUS-strong DET magic PRSP bring-DIR.PROX
 ‘So they did magic, strengthened the magic, and brought it.’
- (20) Gai de ahi ga humai, ga humai huu ga dau i Iaidebaba ma ono
 then DET fire PRSP come.SG PRSP come.SG when PRSP arrive PREP Iaidebaba and 3SG.GEN.O
 dangada, gai gilaadeu gu baakuu gi lalo.
 person then 3PL INC fall.PL to below
 ‘So the fire came and came and when it reached Iaidebaba and his people, they fell down.’
- (21) Gu baakuu gi hongaga de gelegele. Gai gilaadeu ga hulo,
 INC fall.PL to top DET sand then 3PL PRSP go.PL
 ‘They fell down on the beach. They left.’
- (22) hulo laa lalo de baba,
 go.PL DIST below DET flat.surface
 ‘and went down under the seabed.’
- (23) laa lalo de henua, ga seese ai ga loo-adu.
 DIST below DET island PRSP walk OBL PRSP come.PL-DIR.MED
 ‘under the island, and continued to walk toward them.’
- (24) Aagai de gau i modu ga hagataba gu maakau.
 then DET people PREP islet PRSP say INC die.PL
 ‘And the people on the islet said that they died.’
- (25) Gu dee vaa-loomai.
 INC NEG be.able-come.PL-DIR.PROX
 ‘They couldn’t come anymore.’

- (26) Gai gilaadeu ga loo-adu loo-adu, gai gilaadeu ga ea gi
 then 3PL PRSP come.PL-DIR.MED come.PL-DIR.MED then 3PL PRSP surface to
 lunga i dahi modu angeange, kii ange de baa ange.
 above PREP one islet other win DIR.DIST DET be.close DIR.DIST
 ‘But they came and came, and they rose up to the surface on another islet, which was
 closer to them.’
- (27) Gai de gau i modu ga kalo mai.
 then DET people PREP islet PRSP look.PL DIR.PROX
 ‘And the people on the islet looked at them.’
- (28) Oo! Gu kii ange de paa mai. Gai gilaadeu ga helau.
 oh INC win DIR.DIST DET be.close.PL DIR.PROX then 3PL PRSP do.magic
 ‘Oh! They’re closer now.’ So they did magic.’
- (29) Gu baakuu. Gu baakuu gi lalo.
 INC fall.PL INC fall.PL to below
 ‘They fell. They fell below.’
- (30) Gai gilaadeu ga hulo gi lalo. Ga seese adu.
 then 3PL PRSP go.PL to below PRSP walk DIR.MED
 ‘So they went underneath. And they walked toward them.’
- (31) Ga kii adu ange gi ngaiho, gai gilaadeu ga ssao age.
 PRSP win DIR.MED DIR.DIST to north then 3PL PRSP get.out.PL up
 ‘They came further north, and they came back up.’
- (32) Ga tuu gi lunga. Ga kalo mai de gau laa kii ange de paa
 PRSP stand.PL to above PRSP look.PL DIR.PROX DET people DIST win DIR.DIST DET be.close.PL
 adu.
 DIR.MED
 ‘They stood up. When those people looked, they were even closer.’

- (33) Ga hai ai be laa ga loo-adu loo-adu loo-adu
 PRSP do OBL like DIST PRSP come.PL-DIR.MED come.PL-DIR.MED come.PL-DIR.MED
 loo-adu, de hanonga haga-odi ne baakuu ai, ne baakuu i dai
 come.PL-DIR.MED DET iteration CAUS-empty PFV fall OBL PFV fall PREP lagoon
 Ahuilodo.
 Ahuilodo
 ‘So they continued like that, and came and came and came, and the last time that they fell,
 they fell on the lagoon-side of Ahuilodo.’
- (34) Gai gilaadeu ga tuu age huu i de hanonga laa, gu tuu age i bido
 then 3PL PRSP stand.PL up when PREP DET iteration DIST INC stand.PL up PREP side
 i angaiho, Ahuilodo.
 PREP north Ahuilodo
 ‘And when they stood up that time, they stood up on the north side of Ahuilodo.’
- (35) Gai gilaadeu ga helau haga-mmahi.
 then 3PL PRSP do.magic CAUS-strong
 ‘And they did powerful magic.’
- (36) Gai gilaadeu ga haga-baakuu gi lalo.
 then 3PL PRSP CAUS-fall to below
 ‘So they made themselves fall down below.’
- (37) Dee gidee. Hiihidi age huu i de hanonga laa, gu hiihidi age i ma
 NEG see get.up.PL up when PREP DET iteration DIST INC get.up.PL up PREP front
 Tahangahainoo.
 Dahangahainoo
 ‘They couldn’t see them. When they got up that time, they got up in front of Dahanga-
 hainoo.’
- (38) Gai ga hiihidi age huu i mate Dahangahainoo, gai denga gau mai
 then PRSP get.up.PL up when PREP front.DET Dahangahainoo then DET.PL people DIR.PROX
 vaga, ga soosobo ga saavini ga ssulu gi lausedi, ga kau gi de lodo.
 canoe PRSP rise.up.PL PRSP run.PL PRSP dive.PL to salt.water PRSP swim to DET lagoon
 ‘When they got up in front of Dahangahainoo, the foreign people jumped up and ran and
 dove into the water, and swam in the lagoon.’
- (39) Ga hulo ai, go Sualei hugadoo e mua gi dai.
 PRSP go.PL OBL COP.FOC Sualei above.all IPFV front to lagoon
 ‘They continued to swim, but it was Sualei who was the furthest into the lagoon.’

- (40) Ga lava gai denga daane ange laa, ga hagatau adu laa olaadeu ngauda,
 PRSP finish then DET.PL man other DIST PRSP line.up DIR.MED DIST 3PL.GEN.O inland
 de-laa tangada mmahi go Sualei
 DET-DIST DET.person strong COP.FOC Sualei
 ‘And so those other people lined up toward the inland side, and the strongest man Sualei’
- (41) maua gi mao dai. Aagai de gau laa e hedae alodahi donu de ssoe be
 be.able to vast lagoon then DET people DIST IPFV meet all EMPH DET straight like
 laa.
 DIST
 ‘was able to go furthest into the lagoon. And all those other people lined up straight like
 that.’
- (42) Gai denga daane alodahi ga maakau gu maalemo ga aabulu gi lalo i
 then DET.PL man all PRSP die.PL INC drown.PL PRSP sink.PL to below PREP
 taalea, gai ga ssomo ... ga aapulu huu ga hulo gi tagelo de
 DET.tired.PL then PRSP grow.PL PRSP sink.PL when PRSP go.PL to DET.bottom DET
 moana, gai gilaadeu ga ssomo age, olaadeu manu ea i olaadeu angaanga.
 open.sea then 3PL PRSP grow.PL up 3PL.GEN.O coral.head PREP 3PL.GEN.O body
 ‘Then all the men died and drowned and sank down from fatigue, and grew... when they
 sank and went down to the bottom of the ocean, then coral heads grew up from their
 bodies.’
- (43) Denga daane nei.
 DET.PL man PROX
 ‘These men.’
- (44) De-laa ai, ne hai ai naa denga manu ea e hagatau naa laa dai modu
 DET-DIST OBL PFV make OBL MED DET.PL coral.head IPFV line.up MED DIST lagoon islet
 naa, go denga daane de moni o Sualei.
 MED COP.FOC DET.PL man DET canoe GEN.O Sualei
 ‘And so, that’s how the coral heads were formed which are lined up on the lagoon-side of
 those islets, it’s the men of Sualei’s canoe.’
- (45) Aagai go Sualei hugadoo e mua gi dai.
 then COP.FOC Sualei above.all IPFV front to lagoon
 ‘And it’s Sualei who is the furthest into the lagoon.’

- (46) Aa-naa ai, daalanga o Iaidebaba aagu e longo, aama aagu e
 PL-MED OBL story GEN.O Iaidebaba 1SG.GEN.A IPFV hear and 1SG.GEN.A IPFV
 maanadu,
 remember
 ‘So that’s the story of Iaidebaba that I heard, and that I remember.’
- (47) aagu e longo mai i daho de gau maadua.
 1SG.GEN.A IPFV hear DIR.PROX PREP place.GEN DET people old.PL
 ‘that I heard from the older people.’
- (48) Aa-naa ai huu momo mee e iai laa daalanga o Iaidebaba aagu e
 PL-MED OBL when few thing IPFV exist DIST story GEN.O Iaidebaba 1SG.GEN IPFV
 iloo.
 know
 ‘Those are the few things from the story of Iaidebaba that I know.’
- (49) Gu odi ai loo.
 INC empty OBL EMPH
 ‘That’s all.’

A.7 Taalanga o Vave (11-5) – Otto

Speaker: Otto

Date recorded: Spring 1966

Location: Nukuoro Atoll, Pohnpei State, Federated States of Micronesia

Recording information: Reel 11, story 5

Otto describes Vave’s arrival on Nukuoro and the way that his men established the location for the malae, a sacred communal area for worship located on the main islet.

- (1) De masavaa nei gai au e tala hogi momo mee aagu e longo, aama de
 DET time PROX then 1SG IPFV tell also few thing 1SG.GEN.A IPFV hear and DET
 iloo mai i daho de gau maadua i tagodo o Vave.
 know DIR.PROX PREP place.GEN DET people old.PL PREP DET.situation GEN.O Vave
 ‘Right now, I’m going to share a little bit that I heard, that I learned from the older people
 about Vave.’

- (2) Tagodo o Vave, ia ne ulu iho i de ava
 DET.situation GEN.O Vave 3SG PFV enter down PREP DET channel
 'So Vave, he came in through the channel'
- (3) aama lu-oono haolua. Aagai gilaau ga tele,
 and DET.DU-3SG.GEN.O double.hulled.canoe then 3DU PRSP sail.PL
 'with his double-hulled canoe. And they sailed,'
- (4) tele laa de lodo gi ngaiho.
 sail.PL DIST DET lagoon to north
 'sailed in the lagoon to the north.'
- (5) Gilaau ga tele, dahi luu vaga ne dau i Moduboodai.
 3DU PRSP sail.PL one DET.DU canoe PFV arrive PREP Moduboodai
 'They sailed, and one of the canoes landed at Moduboodai.'
- (6) Aagai dahi luu vaga ne dau i Sabini.
 then one DET.DU canoe PFV arrive PREP Sabini
 'And the other canoe landed at Sabini(madogo).'
- (7) Aagai gilaau luu eligi o de vaga, o luu vaga laa, ga loo-age gi
 then 3DU DET.DU captain GEN.O DET canoe GEN.O DET.DU canoe DIST PRSP go.PL-up to
 Sabini, ma Moduboodai ga nnoho ai, gilaadeu ga nnoho ai ga hai ai alaadeu
 Sabini and Moduboodai PRSP live.PL OBL 3PL PRSP live.PL OBL PRSP do OBL 3PL.GEN.A
 me dabu i kilaa ga nnoho ai i kilaa.
 thing sacred PREP there PRSP live.PL OBL PREP there
 'So the two captains of the two canoes, they went up to Sabini and Moduboodai and stayed
 there, they stayed there and did their sacred things there and lived there.'
- (8) Ga nnoho nnoho nnoho nnoho huu, gu pasa gilaau luu eligi bolo gilaau
 PRSP live.PL live.PL live.PL live.PL when INC talk.PL 3DU DET.DU captain COMP 3DU
 ga ahe mai gi de henua laanui.
 PRSP return DIR.PROX to DET island big
 'As they continued to stay there, the two captains decided that they would come back to
 the main island.'
- (9) Gai gilaau ga doo ange olaau mee, gai gilaau ga malanga.
 then 3DU PRSP drop DIR.DIST 3DU.GEN.O thing then 3DU PRSP depart
 'So they packed their things and they left.'

- (10) Dahi e malanga i Moduboodai, gai e dahi e malanga i Sabini.
 one IPFV depart PREP Moduboodai then IPFV one IPFV depart PREP Sabini
 ‘One set sail from Moduboodai, and the other set sail from Sabini.’
- (11) Gai gilaau ga tele mai gi de henua i Hale.
 then 3DU PRSP sail.PL DIR.PROX to DET island PREP Hale
 ‘And they sailed to the main island, Hale.’
- (12) Gai gilaau ga tele mai huu, de moni e mada madangi, de moni i
 then 3DU PRSP sail.PL DIR.PROX when DET canoe IPFV face wind DET canoe PREP
 Sabini ne dau i Delaoage.
 Sabini PFV arrive PREP Delaoage
 ‘As they sailed into the wind, the canoe from Sabini arrived at Delaoage (Laovage).’
- (13) Aagai de moni i Moduboodai, ne dau i Deadulangi.
 then DET canoe PREP Moduboodai PFV arrive PREP Deadulangi
 ‘And the canoe from Moduboodai arrived at Deadulangi.’
- (14) Aagai gilaau ga seese e ange gi olaau magavaa
 then 3DU PRSP walk DIR.DIST to 3DU.GEN.O between
 ‘So they walked toward each other’
- (15) i hong a de henua.
 PREP top DET island
 ‘on land.’
- (16) Tangada i de Delaoage e seese mai i ngaiho, gai tangada i
 DET.person PREP DET Delaoage IPFV walk DIR.PROX PREP north then DET.person PREP
 Deadulangi e seese adu i ngaage
 Deadulangi IPFV walk DIR.MED PREP south
 ‘The person at Delaoage walked from the north and the person at Deadulangi walked from
 the south.’
- (17) Gai gilaau ga loo-ange loo-ange loo-ange gi de momme
 then 3DU PRSP come.PL-DIR.DIST come.PL-DIR.DIST come.PL-DIR.DIST to DET place
 olaau ne heda e ai, de-laa go Saavae.
 3DU.GEN.O PFV meet OBL DET-DIST COP.FOC Saavae
 ‘And they walked and walked until the place where they met, and that was called Saavae.’

- (18) Gai gilaau ga huuhuli. Dahi ga hano gi dai.
 then 3DU PRSP turn.PL one PRSP go.SG to lagoon
 ‘Then they turned. One of them went toward the lagoon.’
- (19) Gai e dahi ga hano gi uda.
 then IPFV one PRSP go.SG to inland
 ‘And one went inland.’
- (20) Dahi ga hano ga ssui luu vae i de lausedi, gai tangada ne
 one PRSP go.SG PRSP get.wet DET.DU foot/leg PREP DET salt.water then DET.person PFV
 hano gi uda gai tangada ga ssui huu luu vae tangada ne hano
 go.SG to inland then DET.person PRSP get.wet when DET.DU foot/leg DET.person PFV go.SG
 gi dai gai ia ga oo.
 to lagoon then 3SG PRSP shout
 ‘One went and got his feet wet in the sea, and the other person went inland. And when
 the person got his feet wet, the person who went in the lagoon, he shouted.’
- (21) Gai tangada ne hano gi uda ga duu.
 then DET.person PFV go.SG to inland PRSP stand
 ‘And the person who went inland stopped.’
- (22) Gai gilaau ga hagailonga de momme e haga-duu ai de Malae.
 then 3DU PRSP mark DET place IPFV CAUS-stand OBL DET malae
 ‘And so they marked the place to build the malae.’
- (23) De-laa ai, ne haga ... hai ai laa, de Malae, i de momme laa.
 DET-DIST OBL PFV CAUS do OBL DIST DET malae PREP DET place DIST
 ‘And so, they built the malae on that spot.’
- (24) Ne hai i hidinga de seese ange o luu daane nei, ga hagailonga ai
 PFV do PREP reason DET walk DIR.DIST GEN.O DET.DU man PROX PRSP mark OBL
 de momme e haga-duu ai de hale dabu go Amalau.
 DET place IPFV CAUS-stand OBL DET house sacred COP.FOC Amalau
 ‘They did it because the walking of these two men marked the place to build the sacred
 house called the Amalau.’

- (25) De-naa ai, gai de lava de-laau mee, gai gilaau ga haga-tuu de
 DET-MED OBL then DET finish DET-3DU.GEN thing then 3DU PRSP CAUS-stand.PL DET
 momme e hai ai mee dabu, gai gilaau ga aahe ai loo gi olaau
 place IPFV do OBL thing sacred then 3DU PRSP return.PL OBL EMPH to 3DU.GEN.O
 momme.
 place
 ‘And so, after they finished, they built the place to do sacred rituals, and they returned to
 their places.’
- (26) Aa-naa ai huu agu mee e longo, i tagodo o Vave,
 PL-MED OBL when 1SG.GEN thing IPFV hear PREP DET.situation GEN.O Vave
 ‘And so, those are the things that I heard about Vave,’
- (27) i d-ono humai gi de henua nei.
 PREP DET-3SG.GEN.O come.SG to DET island PROX
 ‘and his arrival on this island.’
- (28) Gu lava ai loo, aa-naa huu agu momomee e mau i de tala adu,
 INC finish OBL EMPH PL-MED when 1SG.GEN few thing IPFV be.able PREP DET tell DIR.MED
 i tagodo o Vave.
 PREP DET.situation GEN.O Vave
 ‘That’s the end, those are the few things that I can tell you about Vave.’

A.8 Tailalahaodengadubua (11-6) – Otto

Speaker: Otto

Date recorded: Spring 1966

Location: Nukuoro Atoll, Pohnpei State, Federated States of Micronesia

Recording information: Reel 11, story 6

Otto tells the story of Tailalahaodengadubua. In this version, Tailalahaodengadubua is a spirit living on Gausema, who finds a blood clot and raises it, naming it Dologitai. Dologitai travels around with the son of the Nukuoro chief, protecting them from various monsters on their travels.

- (1) Gai de masavaa nei, gai au ga ahe ange nei hogi e tala hanu momo
 then DET time PROX then 1SG PRSP return DIR.DIST PROX also IPFV tell some little
 mee agu e, gu longo, ma de daohi mai i daho de gau maadua
 thing 1SG.GEN IPFV INC hear and DET keep DIR.PROX PREP place.GEN DET people old.PL
 ‘Now, I’m back again to tell you some things that I heard, that I kept from the older people’
- (2) i dagodo o Tailalahaodengadubua.
 PREP situation GEN.O Tailalahaodengadubua
 ‘about Tailalahaodengadubua.’
- (3) De-nei tagodo o Tailalahaodengadubua.
 DET-PROX DET.situation GEN.O Tailalahaodengadubua
 ‘This is the story of Tailalahaodengadubua.’
- (4) Dahi laangi, gai dahi hai bodu.
 one day then one make spouse
 ‘One day there was a married couple.’
- (5) Gilaa e hulo gi Senugu e dada mai ai hanu gai ma-alaau.
 3DU IPFV go.PL to Senugu IPFV pull DIR.PROX OBL some food BEN-3DU.GEN.A
 ‘They were going to Senugu to pick some food for themselves.’
- (6) Aagai d-ono bodu, gu dee magi.
 then DET-3SG.GEN.O spouse INC NEG sick
 ‘And his wife didn’t have her period (i.e., she was pregnant).’
- (7) Aagai gilaa ga hulo huu gi Senugu, aagai de hine laa, gu dai hai hanu
 then 3DU PRSP go.PL when to Senugu then DET woman DIST INC almost do some
 mee.
 thing
 ‘When they went to Senugu, the woman had to go to the bathroom.’
- (8) Aagai ia ga hano gi dai.
 then 3SG PRSP go.SG to lagoon
 ‘So she went to the lagoon.’
- (9) Ga hano iho gi dai Senugu ga gaugau ai, ga hai ai ono mee.
 PRSP go.SG down to lagoon Senugu PRSP swim OBL PRSP do OBL 3SG.GEN.O thing
 ‘She went down to the lagoon at Senugu and swam there, and did her business.’

- (10) Gai ga hai huu, gai tibaa dodo gu ssege.
 then PRSP do when then DET.blood.clot INC miscarry
 ‘But when she was doing that, she miscarried a blood clot.’
- (11) Aagai ia ga ea age gi uda ga hano, ga hano ga dada ana
 then 3SG PRSP surface up to inland PRSP go.SG PRSP go.SG PRSP pull 3SG.GEN.A
 daogoli, aagai tibaa dodo laa ga dahea, ga hano ga hano ga hano, gu
 swamp.taro then DET.blood.clot DIST PRSP drift PRSP go.SG PRSP go.SG PRSP go.SG INC
 hano laa hongade hale o Tailalahaodengadubua.
 go.SG DIST top DET house GEN.O Tailalahaodengadubua
 ‘So she got out of the water and went to shore, and went to pick her taro, and that blood
 clot drifted on and on and on and went over the house of Tailalahaodengadubua.’
- (12) Aagai Tailalahaodengadubua, ga han-ange ga gaa-mai tibaa dodo
 then Tailalahaodengadubua PRSP go.SG-DIR.DIST PRSP bring-DIR.PROX DET.piece blood
 laa, gai ia ga hakaugau.
 DIST then 3SG PRSP CAUS.bathe
 ‘So Tailalahaodengadubua went over and brought the blood clot and he bathed it.’
- (13) Ga hakaugau ga hakaugau ga gaav-ange denga mee alodahi hugadoo ga
 PRSP CAUS.bathe PRSP CAUS.bathe PRSP give-DIR.DIST DET.PL thing all above.all PRSP
 hakaugau ai de mmahi ma ssauaa ma me alodahi hugadoo ga hakaugau
 CAUS.bathe OBL DET strong.PL and DET.power and thing all above.all PRSP CAUS.bathe
 ai tibaa dodo laa, gu hai ai se dama se angaanga dangada donu.
 OBL DET.piece blood DIST INC make OBL COP.SG child COP.SG body person EMPH
 ‘He bathed it and bathed it, and he brought everything and bathed it in strength and
 power, and he bathed that blood clot until it became a child, with the body of a person.’
- (14) Aagai de bodu o de hine laa, d-ono ingoo go Mulidoloa.
 then DET spouse GEN.O DET woman DIST DET-3SG.GEN.O name COP.FOC Mulidoloa
 ‘The woman’s husband, his name was Mulidoloa.’

- (15) Aagai Tailalahaodengadubua ga hakaugau ga hakaugau huu gu se dama
 then Tailalahaodengadubua PRSP CAUS.bathe PRSP CAUS.bathe when INC COP.SG child
 tibaa dodo laa, gu se daane danuaa donu gu se gauligi madua, gai ia
 DET.piece blood DIST INC COP.SG man good EMPH INC COP.SG child old then 3SG
 ga ssala adu Mulidoloa.
 PRSP look.for DIR.MED Mulidoloa
 ‘And as Tailalahaodengadubua bathed it, he bathed that blood clot into a child, into a
 real man, into a full grown child, and he went to search for Mulidoloa.’
- (16) Ia gi han-adu loo e gaa-mai de-laau dama.
 3SG SBJV go.SG-DIR.MED EMPH IPFV bring-DIR.PROX DET-3DU.GEN child
 ‘For him to come and take their child.’
- (17) Aagai Mulidoloa ga han-adu gai ia ga hai ange, de-nei taau
 then Mulidoloa PRSP go.SG-DIR.MED then 3SG PRSP say DIR.DIST DET-PROX DET.1DU.INCL
 dama, gaavee loo e hulo gooluu gu odi naa hugadoo i d-agu
 child take.CIA EMPH IPFV go.PL 2DU INC empty MED above.all PREP DET-1SG.GEN.A
 hakaugau ono dagodo.
 CAUS.bathe 3SG.GEN.O DET.situation
 ‘So Mulidoloa came, and he (Tailalahaodengadubua) said, This is our child, take him
 and go, I’m finished caring for him.’
- (18) Aagai de-nei de ingoo taau dama. E tuu lua ai lu-odaau
 then DET-PROX DET name DET.1DU.INCL child IPFV cut two OBL DET.DU-1DU.INCL.GEN.O
 ingoo.
 name
 ‘And this is the name of our child. It is the combination of our two names.’
- (19) D-oo ingoo, go Mulidoloa.
 DET-2SG.GEN.O name COP.FOC Mulidoloa
 ‘Your name is Mulidoloa.’
- (20) Gai d-ogu ingoo, go Tailalahaodengadubua.
 then DET-1SG.GEN.O name COP.FOC Tailalahaodengadubua
 ‘My name is Tailalahaodengadubua.’
- (21) Aagai ia ga haga-ingoo ange bolo go...
 then 3SG PRSP CAUS-name DIR.DIST COMP COP.FOC
 ‘And so he will be called...’

- (22) Gai de-nei de ingoo o taau dama.
 then DET-PROX DET name GEN.O DET.1DU.INCL child
 ‘So this is the name of our child.’
- (23) Gu tuu lua ai lu-odaau ingoo.
 INC cut two OBL DET.DU-1DU.INCL.GEN.O name
 ‘It is the combination of our two names.’
- (24) Go Dologitai. Dolo, go Mulidoloa.
 COP.FOC Dologitai dolo COP.FOC Mulidoloa
 ‘It is Dologitai. Dolo, from Mulidoloa.’
- (25) Gai tai, go Tailahalahaodengadubua.
 then tai COP.FOC Tailahalahaodengadubua
 ‘Tai, from Tailahalahaodengadubua.’
- (26) Gai gaavee loo taau dama ma dali goe gu odi ange naa loo
 then take.CIA EMPH DET.1DU.INCL child with 2SG INC empty DIR.DIST MED EMPH
 ono hakaugau i d-agu hakaugau ai.
 3SG.GEN.O CAUS.bathe PREP DET-1SG.GEN.A CAUS.bathe OBL
 ‘So take our child with you, my process of washing him is finished.’
- (27) Gai gooluu ga nnoho ai. Aagai tangada laa ga kave d-ana dama, ga
 then 2DU PRSP live.PL OBL then DET.person DIST PRSP take DET-3SG.GEN.A child PRSP
 hulo gilaau.
 go.PL 3DU
 ‘So the two of them stayed there. And that person took his child and they left.’
- (28) Aagai dahi laangi huu, aagai tama haga-hodooligi e lodo e hano e holi-age
 then one day when then DET.child CAUS-chief IPFV want IPFV go.SG IPFV circle-up
 de langi, e tilo ai mee alodahi, e hagadaahao ai
 DET sky IPFV look OBL thing all IPFV play OBL
 ‘One day, the future king wanted to circle the heavens and look at everything and go
 sightseeing’
- (29) e tilo ai tagodo de holi-age o de langi.
 IPFV look OBL DET.situation DET circle-up GEN.O DET sky
 ‘to see what the heavens looked like.’

- (30) Agai ... gai ia ga hai ange gi tangada laa
 then then 3SG PRSP say DIR.DIST to DET.person DIST
 'So he said to that person'
- (31) bolo ia e lodo e kave Dologitai e hulo gilaau e holiage de langi e
 COMP 3SG IPFV want IPFV take Dologitai IPFV go.PL 3DU IPFV circle-up DET sky IPFV
 hagadaahao ai.
 play OBL
 'that he wanted to take Dologitai and go with him to circle the heavens and see the sights.'
- (32) Aagai Mulidoloa ga hai ange bolo e danuaa danuaa.
 then Mulidoloa PRSP say DIR.DIST COMP IPFV good good
 'And Mulidoloa said that this was okay.'
- (33) Gai de-nei ono dagodo.
 then DET-PROX 3SG.GEN.O situation
 'And this was what he said.'
- (34) Ga hulo naa huu gooluu e hai d-oo hano-nga, aagai ga loo-adu
 PRSP go.PL IRR when 2DU IPFV do DET-2SG.GEN go.SG-NMLZ then PRSP go-DIR.MED
 naa huu gooluu ni mee hodoologi e paa mai i ooluu mada
 MED when 2DU COP.PL thing chief IPFV be.close.PL DIR.PROX PREP 2DU.GEN front
 i mua, aagai koe ga hano ai loo gi mada i mua.
 PREP front then 2SG PRSP go.SG OBL EMPH PREP front PREP front
 'When you two go and make your journey, when you go, there will be spirits that will
 appear before you, and you must go in front.'
- (35) Gai ga loo-adu naa huu gooluu gu ni mee haga-daane e haga-mmahi
 then PRSP go-DIR.MED IRR when 2DU INC COP.PL thing CAUS-man IPFV CAUS-strong
 e hai, agai ia ga dugu mai goe gi ono dua.
 IPFV do so 3SG PRSP put DIR.PROX 2SG to 3SG.GEN.O back
 'As you go, there will be shapeshifters that are difficult to defeat, so he will put you behind
 him.'
- (36) Aagai ia ga hano i mua. De-laa ai.
 then 3SG PRSP go.SG PREP front DET-DIST OBL
 'And he will go in front. So that's how it will be.'

- (37) Ga dae huu gi de-laau malanga e hulo e holi-age e kave tama
 PRSP reach when to DET-3DU.GEN set.sail IPFV go.PL IPFV circle-up IPFV take DET.child
 haga-hodooligi, aagai gilaau ga hulo be laa.
 CAUS-chief then 3DU PRSP go.PL like DIST
 ‘When the time came for them to set sail and circle the heavens and take the young chief,
 they went like that.’
- (38) Ga hulo ga loo-adu loo-adu naa huu gu ni mee mmahi e
 PRSP go.PL PRSP go.PL-DIR.MED go.PL-DIR.MED IRR when INC COP.PL thing strong IPFV
 dee bau ange laa tama haga-hodooligi agina, gai ia, ga dugu mai gi
 NEG be.equal.to DIST DET.child CAUS-chief there then 3SG PRSP put DIR.PROX to
 ono dua.
 3SG.GEN.O back
 ‘As they sailed and sailed, there were strong things that the future king could not stand
 against, so he put him behind him.’
- (39) Agai ia ga hano i mada i mua.
 then 3SG PRSP go.SG PREP front PREP front
 ‘And he went in front.’
- (40) Gilaauga loo-adu loo-adu huu e dahi dabula, e dagodo i de baasi
 3DU PRSP go-DIR.MED go-DIR.MED when IPFV one lizard IPFV lie.down PREP DET side
 langi laa ma e lui ai e dee iloo de loo-adu e hulo ai.
 sky DIST and IPFV turn OBL IPFV NEG know DET go.PL-DIR.MED IPFV go.PL OBL
 ‘As they sailed and sailed, there was a lizard laying across half of the sky and blocking
 their path, and they weren’t able to go past.’
- (41) Gai ia ga loo-adu loo-adu, gai ia ga hai tuua nui
 then 3SG PRSP go.PL-DIR.MED go.PL-DIR.MED then 3SG PRSP do DET.ridge.of.coconut.leaf
 gai ia ga badu ai tua de biho o tabula.
 then 3SG PRSP kick/hit OBL back DET head GEN.O DET.lizard
 ‘So he went and went, and he took the ridge of the coconut palm leaf and he hit the lizard
 in the back of the head.’
- (42) Gai tabula ga dangage age lalo de ua, gai gilaau ga ulu laa lalo
 then DET.lizard PRSP raise.head up below DET neck then 3DU PRSP enter DIST below
 o tabula ga hulo ai.
 GEN.O DET.lizard PRSP go.PL OBL
 ‘Then the lizard raised up his head and they sailed under the lizard and went on.’

- (43) Gai ga ssao i de baasi laa, gai tabula ga basa adu, Go ai
 then PRSP escape.PL PREP DET side DIST then DET.lizard PRSP talk DIR.MED COP.FOC who
 de-nei? Ni a ai goe?
 DET-PROX COP.PL GEN.A who 2SG
 ‘So they escaped to the other side, and the lizard said to them, Who is this? Who do you
 belong to?’
- (44) Gai ia ga hai ange, Tailalahaodengadubua.
 then 3SG PRSP say DIR.DIST Tailalahaodengadubua
 ‘And he said, Tailalahaodengadubua.’
- (45) Gai tabula ga hai ange, Au ga sano.
 then DET.lizard PRSP say DIR.DIST 1SG PRSP give.up
 ‘So the lizard said, I surrender.’
- (46) Aagai Dologitai ga dau dengaa mana o tabula ga kave gu kii
 then Dologitai PRSP put.on DET.PL.SUP power GEN.O DET.lizard PRSP take INC increase
 ange de mmahi.
 DIR.DIST DET strong
 ‘So Dologitai took the lizard’s powers and his strength became greater.’
- (47) Gai gilaaui ga loo-adu, loo-adu be laa.
 then 3DU PRSP go.PL-DIR.MED go.PL-DIR.MED like DIST
 ‘So the two continued on that way.’
- (48) Loo-adu loo-adu gu ni mee hodooligi e paa mai mada
 go.PL-DIR.MED go.PL-DIR.MED INC COP.PL thing chief IPFV be.close.PL DIR.PROX front
 i mua, aagai tama hodooligi ga dugu go go ia e hano i
 PREP front then DET.child chief PRSP put COP.FOC COP.FOC 3SG IPFV go.SG PREP
 mua.
 front
 ‘As they sailed and sailed, there were spirits that came before them, so the young chief
 allowed him to go in front.’
- (49) Gai ga ui naa huu i denga mee haga-hodooligi laa gu ni mee baubau,
 then PRSP pass IRR when PREP DET.PL thing CAUS-chief DIST INC COP.PL thing bad
 dagodo mai e dahi manu de boo.
 lay DIR.PROX IPFV one centipede
 ‘So when they passed those spirits, there were monsters, a centipede was laying there.’

- (50) Gai gilaau ga loo-adu. Gai ia gu dugu mai tama hodoologi gi
 then 3DU PRSP go.PL-DIR.MED then 3SG INC put DIR.PROX DET.child chief to
 ono dua gai ia ga hano i mua.
 3SG.GEN.O back then 3SG PRSP go.SG PREP front
 ‘So they went. Then he put the young chief behind him and he went in front.’
- (51) Gai ia ga loo-adu loo-adu huu, gai ia ga hai
 then 3SG PRSP go.PL-DIR.MED go.PL-DIR.MED when then 3SG PRSP do
 tuaa nui ga badu ai lote dua de manu de boo gai de
 DET.ridge.of.coconut.palm PRSP kick OBL inside.DET back DET centipede then DET
 manu de boo ga bigo ga malanga tinae, gai gilaau ga hulo laa lalo tinae
 centipede PRSP bent PRSP lift.up DET.belly then 3DU PRSP go.PL DIST below DET.belly
 ga hulo ai.
 PRSP go.PL OBL
 ‘As they went and went, he took the ridge of the coconut palm and struck it into the cen-
 tipede’s back, and the centipede bent and lifted up his belly, and they went under his belly
 and went on.’
- (52) Gai gilaau ga hulo gi de baasi gee.
 then 3DU PRSP go.PL to DET side away
 ‘And they went to the other side.’
- (53) Gai gu basa adu de manu de boo, Ni a ai goe?
 then INC talk DIR.MED DET centipede COP.PL GEN.A who 2SG
 ‘So the centipede said, Who do you belong to?’
- (54) Go ai aa-nei? Gai ia ga hai ange,
 COP.FOC who PL-PROX then 3SG PRSP say DIR.DIST
 ‘Who are you? So he said,’
- (55) Au ni Tailalahaodengadubua.
 1SG COP.PL Tailalahaodengadubua
 ‘I am Tailalahaodengadubua.’
- (56) Gai de manu de boo ga hai ange, Au ga sano.
 then DET centipede PRSP say DIR.DIST 1SG PRSP give.up
 ‘So the centipede said, I surrender.’

- (57) Aagai ia ga dau mana o de manu de boo ga kave.
 then 3SG PRSP put.on power GEN.O DET centipede PRSP take
 'So he took the centipede's power.'
- (58) Gu kii ange de mmahi.
 INC increase DIR.DIST DET strong
 'His strength increased.'
- (59) Gai gilaau ga hulo ai be laa i denga dagodo alodahi hugadoo e hedae
 then 3DU PRSP go.PL OBL like DIST PREP DET.PL situation all above.all IPFV meet
 ange gi gilaau i denga mee baubau.
 DIR.DIST to 3DU PREP DET.PL thing bad
 'They continued that way every time they encountered monsters.'
- (60) Loo-adu loo-adu huu, de baasi langi i ngaage, Buadada e hai
 go.PL-DIR.MED go.PL-DIR.MED when DET side sky PREP south Buadada IPFV do
 d-ana guani ma e dugu, ma e dada ai denga hudaa moni ma denga
 DET-3SG.GEN.A fish.trap and IPFV put and IPFV pull OBL DET.PL fleet canoe and DET.PL
 daholaa ma mee alodahi hugadoo i de moana
 fish and thing all above.all PREP DET open.sea
 'As they continued to go, in the southern half of the sky, Buadada made his fish trap and set it, and he pulled in fleets of canoes and the fish and every last thing in the sea'
- (61) i de baasi langi i ngaage laa. Gai ia ga dada mai.
 PREP DET side sky PREP south DIST then 3SG PRSP pull DIR.PROX
 'to the southern half of the sky. So he pulled it in.'
- (62) Gu odi gi te galauna gai ia ga dada dada mai.
 INC empty to inside.DET big.net then 3SG PRSP pull pull DIR.PROX
 'Everything was inside the net so he pulled and pulled it in.'
- (63) Gaa-mai ga gai.
 bring-DIR.PROX PRSP eat
 'He brought it in and ate it.'

- (64) Gai ga loo-adu luu dama laa ga loo-adu, gidee de galauna laa
 then PRSP go.PL-DIR.MED DET.DU child DIST PRSP go.PL-DIR.MED see DET big.net DIST
 gai gilaau ga poo i tua de galauna.
 then 3DU PRSP grab PREP DET.back DET big.net
 ‘So as the two children continued, they saw the big net, and they grabbed on to the back
 of the net.’
- (65) Gai tangada laa ga hhudi.
 then DET.person DIST PRSP pull
 ‘So the person pulled it in.’
- (66) Ga hhudi hhudi hhudi adu gu dae adu gu dai dae adu gi gaogao
 PRSP pull pull pull DIR.MED INC reach DIR.MED INC almost reach DIR.MED to near
 de ... gu baa mai donu ia, gai gilaau ga langa de galauna ga vini
 DET INC be.close DIR.PROX EMPH 3SG then 3DU PRSP lift DET fishing.net PRSP pinch
 ai tangada laa.
 OBL DET.person DIST
 ‘He pulled and pulled and pulled, and when they were almost near him, they lifted the net
 and pinched the man.’
- (67) Gu gii age tangada laa, Ee go ai aa-nei?
 INC high.pitched.sound up DET.person DIST VOC COP.FOC who PL-PROX
 ‘That person cried out, Who is this?’
- (68) Ni a ai goe? Gai ia ga hai ange,
 COP.PL GEN.A who 2SG so 3SG PRSP say DIR.DIST
 ‘Who do you belong to? And he replied,’
- (69) Au ni Tailalahaodengadubua.
 1SG COP.PL Tailalahaodengadubua.
 ‘I am Tailalahaodengadubua.’
- (70) Gai tangada laa ga hai ange, Au ga sano.
 then DET.person DIST PRSP say DIR.DIST 1SG PRSP give.up
 ‘So the person said to him, I surrender.’

- (71) Aagai ia ga dau denga mana o Buadada ga kave gu kii ange de
 then 3SG PRSP put.on DET.PL power GEN.O Buadada PRSP take INC increase DIR.DIST DET
 mmahi. Aagai gilaau ga hulo be laa.
 strong then 3DU PRSP go.PL like DIST
 ‘So he took Buadada’s powers and added them to his strength. So the two of them went
 away in that manner.’
- (72) Loo-iho. Ga loo-iho laa, de eidu tege de langi e duu vae dahi
 come.PL-down PRSP come.PL-down DIST DET ghost DET.hip DET sky IPFV stand leg one
 ma e langa ai de baasi langi laa.
 and IPFV lift OBL DET side sky DIST
 ‘They came down. They came down there, and ghost in the corner of the sky stood on
 one leg and lifted the side of the sky there.’
- (73) Gai denga eidu alodahi e loo-mai ma e daudau.
 then DET.PL ghost all IPFV come.PL-DIR.PROX and IPFV wrestle
 ‘The ghosts all came and wrestled him.’
- (74) Loo-mai e daudau e dee maua i de haga-baguu.
 come.PL-DIR.PROX IPFV wrestle IPFV NEG be.able PREP DET CAUS-fall.over
 ‘They came to wrestle him but they were not able to make him fall over.’
- (75) Loo-mai e daudau de vae dahi laa e dee maua donu gi ngalue.
 come.PL-DIR.PROX IPFV wrestle DET leg one DIST IPFV NEG be.able EMPH to move
 ‘They came to wrestle him but they weren’t able to get the leg to move.’
- (76) Gai ia ga han-adu hano hano ga daudau de eidu vae dahi laa.
 then 3SG PRSP go.SG-DIR.MED go.SG go.SG PRSP wrestle DET ghost leg one DIST
 ‘So he came up and wrestled the one-legged ghost.’

- (77) Ga loo-adu donu huu ga damaa tuu adu donu huu gai ia ga
 PRSP come.PL-DIR.DIST EMPH when PRSP little cut DIR.MED EMPH when then 3SG PRSP
 badu salulu gu hadi de vae o de eidu laa gu doo iho de baasi
 kick explosion.noise INC break DET leg GEN.O DET ghost DIST INC drop down DET side
 langi laa gu vaa de henua gu maakau loo gidaadeu gu deai se hai e
 sky DIST INC do.wrong DET island INC die.PL EMPH 1PL.INCL INC no COP.SG do IPFV
 maua ai gi danuaa de momme nei, gu doo iho de langi nei.
 be.able OBL to good DET place PROX INC drop down DET sky PROX
 ‘As they went up and cut him a little bit, he kicked forcefully and broke the ghost’s leg
 so that half of the sky would fall down, the earth would become wrong, we would all die,
 and there would be no way to fix it, the sky would fall down.’
- (78) Gai ia ga hanadu ga poo dahi luu lima ga velo gi lunga gi de baasi
 then 3SG PRSP go-toward.2 PRSP touch one DET.DU arm PRSP stab to above to DET side
 laa, gai ia ga dugu mai de eidu laa ga hai gu danuaa d-ono vae,
 DIST so 3SG PRSP put DIR.PROX DET ghost DIST PRSP do INC good DET-3SG.GEN.O leg
 ga haga-duu ange gi d-ono logunga, ga haga-duu ai, gu danuaa.
 PRSP CAUS-stand DIR.DIST to DET-3SG.GEN.O cornerstone PRSP CAUS-stand OBL INC good
 ‘Then he went over and took one of his arms and thrust it up into that side of the sky,
 and he allowed that ghost to fix his leg, and stand there in the corner, and stand there so
 that all was well.’
- (79) Ga basa adu de eidu laa, Ni a ai goe?
 PRSP talk DIR.MED DET ghost DIST COP.PL GEN.A who 2SG
 ‘The ghost said, Who do you belong to?’
- (80) Gai ia ga hai ange, Au ni Tailalahaodengadubua.
 then 3SG PRSP say DIR.DIST 1SG COP.PL Tailalahaodengadubua
 ‘And he said, I am Tailalahaodengadubua.’
- (81) Agai ia ga hai ange, Au ga sano.
 then 3SG PRSP say DIR.DIST 1SG PRSP give.up
 ‘And the ghost said, I surrender.’
- (82) Gai ia ga dau mana o de eidu laa ga kave
 then 3SG PRSP put.on power GEN.O DET ghost DIST PRSP take
 ‘So he took the powers of the ghost’

- (83) ma gu kii angeange de mmahi.
and INC increase again DET strong
'and his power increased again.'
- (84) Ga hulo ai gilaaui be laa gu ngani de langi de hagadaahao tama
PRSP go.PL OBL 3DU like DIST INC encircle DET sky DET play DET.child
haga-hodooligi, gai gilaaui ga aahe mai ai loo ga aahe mai
CAUS-chief then 3DU PRSP return.PL DIR.PROX OBL EMPH PRSP return.PL DIR.PROX
ga gaa-mai gaav-ange tama laa gi daho ono maadua go
PRSP bring-DIR.PROX bring-DIR.DIST DET.child DIST to place.GEN 3SG.GEN.O parents COP.FOC
denga hodooligi, aagai ia ga ahe gi d-ono momme.
DET.PL chief then 3SG PRSP return to DET-3SG.GEN.O place
'So they continued that way and circled the sky so that the young chief could sightsee,
and the two of them returned, they returned and he brought that child back to his parents,
the chiefs, and he returned to his home.'
- (85) De-nei ai, momo mee agu e longo ma de iloo i dagodo o
DET-PROX OBL few thing 1SG.GEN.A IPFV hear and DET know PREP situation GEN.O
Tailahalahaodengadubua, aagai de ingoo o tama ana ne hakaugau
Tailahalahaodengadubua then DET name GEN.O DET.child 3SG.GEN.A PFV CAUS.bathe
laa, e haga-ingoo ange bolo go Dologitai, e tuu lua ai ingoo olaau
DIST IPFV CAUS-name DIR.DIST COMP COP.FOC Dologitai IPFV cut two OBL name 3DU.GEN.O
ma d-ono damana, go Mulidoloa.
and DET-3SG.GEN.O father COP.FOC Mulidoloa
'And so, these are the few things that I heard and know about the story of Tailahalahaodengadubua, and the name of the child that he raised, which was named Dologitai, which was combined from the two names of him and his father Mulidoloa.'
- (86) Aa-naa ai huu agu mee e mau, aama de daohi i mee i taalanga
PL-MED OBL when 1SG.GEN.A thing IPFV be.able and DET hold PREP thing PREP DET.story
o Dologitai.
GEN.O Dologitai
'Those are the things I am able to remember from the story of Dologitai.'
- (87) Gu lava ai loo. Aa-naa huu agu momo mee.
INC finish OBL EMPH PL-MED when 1SG.GEN.A few thing
'I am finished. Those are my few things.'

A.9 Taalanga o Vave (11-8) – Leaba

Speaker: Leaba

Date recorded: Spring 1966

Location: Nukuoro Atoll, Pohnpei State, Federated States of Micronesia

Recording information: Reel 11, story 8

Leaba tells the story of Vave's arrival on Nukuoro, with a particular focus on Vave's encounters with local spirits and the progression of the traditional religion. Vave and his family end up trapped at sea due to a spell that is placed on them by the people of Oneop, which results in Vave sacrificing himself and turning into a whale.

- (1) Ga noho laa huu a Vave ma d-ono dinana, ma d-ono daina.
PRSP live DIST when PN Vave and DET-3SG.GEN.O mother and DET-3SG.GEN.O sibling
'Once upon a time, there lived Vave and his mother and his brother.'
- (2) Dahi laangi gai gilaadeu ga pasa i mee hai i dagodo-nga o de henua
one day then 3PL PRSP talk.PL PREP thing do PREP lay-NMLZ GEN.O DET island
go Samoa.
COP.FOC Samoa
'One day, they were talking about what they were doing with the traditional religion of Samoa.'
- (3) Gai de-laau dinana, e haga-buni ange huu gi tamaa gauligi.
then DET-3DU.GEN mother IPFV CAUS-join DIR.DIST when to DET.child young
'And their mother favored the younger child.'
- (4) Gai a Vave gu lili. Gai a Vave ga hano.
then PN Vave INC angry then PN Vave PRSP go.SG
'And Vave became angry. So Vave left.'
- (5) Hano e haga-magau.
go.SG IPFV CAUS-die
'Left to commit suicide.'
- (6) Gai ia ga hu-mai ga gaa-mai d-ono bodu, ma Inahia
then 3SG PRSP come.SG-DIR.PROX PRSP bring-DIR.PROX DET-3SG.GEN.O spouse and Inahia
ma Gausugilogo.
and Gausugilogo
'So he came and brought his wife, and Inahia and Gausugilogo.'

- (7) Gilaadeu ga loo ... ma e dogo-haa ange hai bodu.
 3PL PRSP come.PL and IPFV CL.HUM-four DIR.DIST make spouse
 ‘They came with four other couples.’
- (8) Gilaadeu ga loo-mai.
 3PL PRSP come.PL-DIR.PROX
 ‘They came.’
- (9) Gai gilaadeu ga loo-mai huu, loo-mai ga de-laadeu momme
 then 3PL PRSP come.PL-DIR.PROX when come.PL-DIR.PROX PRSP DET-3PL.GEN place
 ne tau ai, go dua Devaihenua.
 PFV arrive.PL OBL COP.FOC back Devaihenua
 ‘So when they came, the place where they arrived was the ocean-side of Devaihenua.’
- (10) Gilaadeu ga tau huu i dua Devaihenua, gai gilaadeu ga loo-age gi
 3PL PRSP arrive.PL when PREP back Devaihenua then 3PL PRSP come.PL-up to
 uda.
 inland
 ‘When they arrived at the ocean-side of Devaihenua, they went up to shore.’
- (11) Ga loo-age huu gi uda, gai a Vave, e kona de lili ange ... Inahia,
 PRSP come.PL-up when to inland then PN Vave IPFV very DET angry DIR.DIST Inahia
 e lodo e hai gi ni-oona de bodu go Inahia, agai d-ono
 IPFV want IPFV make to COP.PL-3SG.GEN.O DET spouse COP.FOC Inahia then DET-3SG.GEN.O
 bodu go Gausugilogo.
 spouse COP.FOC Gausugilogo
 ‘When they got to shore, Vave was very angry... he wanted to make Inahia his wife, but
 his wife was Gausugilogo.’
- (12) Gai gilaadeu ga loo-mai ga nnoho i de henua go Madalama.
 then 3PL PRSP come.PL-DIR.PROX PRSP live.PL PREP DET island COP.FOC Madalama
 ‘So they came and lived on the island of Madalama (Nukuoro).’
- (13) Ga nnoho nnoho huu gilaadeu, gai dengaa eidu e lili.
 PRSP live.PL live.PL when 3PL then DET.PL.SUP ghost IPFV angry.PL
 ‘And as they lived there, the ghosts were upset.’
- (14) E dee llodo i de loo-mai o ... gi nnoho i de henua nei.
 IPFV NEG want.PL PREP DET come.PL-DIR.PROX GEN.O to live.PL PREP DET island PROX
 ‘They didn’t want people to come and stay on this island.’

- (15) Gai gilaadeu ga loo-mai e he-bagi ange agina.
 then 3PL PRSP come.PL-DIR.PROX IPFV RCPR-fight DIR.DIST OBL
 ‘So they came to fight with those people.’
- (16) Gilaadeu ga loo-mai e he-bagi ange gi a Vave ma de moni laa.
 3PL PRSP come.PL-DIR.PROX IPFV RCPR-fight DIR.DIST to PN Vave and DET canoe DIST
 ‘They came to fight with Vave and his companions.’
- (17) Gilaadeu ga loo-mai huu e he-bagi ange gi a Vave, gai e dahi
 3PL PRSP come.PL-DIR.PROX when IPFV RCPR-fight DIR.DIST to PN Vave then IPFV one
 dangada gu hu-mai d-ono ingoo go ... gai e dahi dangada
 person INC come.SG-DIR.PROX DET-3SG.GEN.O name COP.FOC then IPFV one person
 d-ono ingoo go Gaeuli.
 DET-3SG.GEN.O name COP.FOC Gaeuli
 ‘When they came to fight with Vave, there was a person who came whose name was... a
 person whose name was Gaeuli.’
- (18) Se dangada hogi o dahi henua. Gai ia ga hu-mai.
 COP.SG person also GEN.O one island then 3SG PRSP come.SG-DIR.PROX
 ‘He was a person from a different island. So he came.’
- (19) Gai ia ga hu-mai ga hhudi mai d-ana libo, ga
 then 3SG PRSP come.SG-DIR.PROX PRSP pull.in DIR.PROX DET-3SG.GEN.A jackfish PRSP
 hu-mai ai.
 come.SG-DIR.PROX OBL
 ‘He came and caught his jackfish, as he came there.’
- (20) Ga hu-mai ga noho i Langiasa.
 PRSP come.SG-DIR.PROX PRSP live PREP Langiasa
 ‘He came and stayed at Langiasa.’
- (21) Ga dunu ai. Gai tigi mmoa loo, gai dengaa eidu ga loo-mai
 PRSP cook OBL then not.yet cooked EMPH then DET.PL.SUP ghost PRSP come.PL-DIR.PROX
 ga tala d-ono moni.
 PRSP untie DET-3SG.GEN.O canoe
 ‘So he cooked it. And it wasn’t fully cooked yet, and the ghosts came and untied his canoe.’

- (22) Tili gi dahea. Gai ia ga ahe ga gaa-mai ga nnoa.
 let.go SBJV drift then 3SG PRSP return PRSP bring-DIR.PROX PRSP tie
 ‘They let it drift away. So he went and brought it back and tied it.’
- (23) Gai ia ga hu-mai ga dunu d-ana mamu tigi mmoa loo,
 then 3SG PRSP come.SG-DIR.PROX PRSP cook DET-3SG.GEN.A fish not.yet cooked EMPH
 gai denga eidu ga loo-mai ga tala gu dahea.
 then DET.PL ghost PRSP come.PL-DIR.PROX PRSP untie INC drift
 ‘So he came and cooked his fish, it wasn’t cooked yet, and the ghosts came and untied his
 canoe and it drifted away.’
- (24) De-laa ai donu huu, ga hano hano huu gai ia ga ahe.
 DET-DIST OBL only PRSP go.SG go.SG when then 3SG PRSP return
 ‘So that’s how it was, so he went and he returned back.’
- (25) Gai ia ga tala d-ono moni, gai ia ga ahe.
 then 3SG PRSP untie DET-3SG.GEN.O canoe then 3SG PRSP return
 ‘He untied his canoe, and he went back.’
- (26) Gai a Vave, e noho ai huu i de henua nei.
 then PN Vave IPFV live OBL when PREP DET island PROX
 ‘And Vave stayed on this island.’
- (27) Gai denga eidu o Sogo, de laangi nei gai gilaadeu e loo-mai e
 then DET.PL ghost GEN.O Sogo DET day PROX then 3PL IPFV come.PL-DIR.PROX IPFV
 he-bagi ange agina.
 RCPR-fight DIR.DIST OBL
 ‘And Sogo’s ghosts, on that day they came to fight them.’
- (28) De laangi nei gai gilaadeu e loo-mai e he-bagi ange agina.
 DET day PROX then 3PL IPFV come.PL-DIR.PROX IPFV RCPR-fight DIR.DIST OBL
 ‘That day they came to fight them.’
- (29) Ga hano hano huu e dahi laangi, gai a Vave gu maanadu bolo ia ga ahe.
 PRSP go.SG go.SG when IPFV one day then PN Vave INC think COMP 3SG PRSP return
 ‘So one day, Vave decided to return.’

- (30) Bolo ia ga ahe. Gai ga aahe huu gilaadeu, ga hano huu a Vave gi
 COMP 3SG PRSP return then PRSP return.PL when 3PL PRSP go.SG when PN Vave to
 hongade moni, gai ia ga oo mai gi de gau de henua.
 top DET canoe then 3SG PRSP shout DIR.PROX to DET people DET island
 ‘He decided to return. And when they returned, when Vave got onto the canoe, he shouted
 to the people on the island.’
- (31) Au ga hano nei loo, gai denga Ahubaua, go de Lulu e diiloo
 1SG PRSP go.SG PROX EMPH then DET.PL Ahubaua COP.FOC DET Lulu IPFV look.after.CIA
 ange, hai ai dagodo-nga o de henua.
 DIR.DIST do OBL lay-NMLZ GEN.O DET island
 ‘I am leaving, but the Ahubaua, it’s Delulu (Vave’s son) who will look after them, and
 maintain the religion of the island.’
- (32) Agai denga modu e dolu i ngaage, ni-oo dengaa aligi e hai
 then DET.PL islet IPFV three PREP south COP.PL-GEN.O DET.PL leader IPFV do
 dagodo-nga.
 lay-NMLZ
 ‘And the three islets to the south, it’s up to the religious leaders to maintain the traditional
 religion.’
- (33) Gai ia ga ahe ai loo.
 then 3SG PRSP return OBL EMPH
 ‘And so he left.’
- (34) Ga ahe, ga hulo gilaadeu ma bodu o lu-aana dama, ma
 PRSP return PRSP go.PL 3PL and spouse GEN.O DET.DU-3SG.GEN.A child and
 d-ono bodu, gilaadeu ga hulo.
 DET-3SG.GEN.O spouse 3PL PRSP go.PL
 ‘So they returned, him and the spouse of his two children, and his wife, they left.’
- (35) Ga hulo huu gilaadeu ga too gi de moana, gai a Vave ga hai ange.
 PRSP go.PL when 3PL PRSP drop.PL to DET open.sea then PN Vave PRSP say DIR.DIST
 ‘As they went and entered the open sea, Vave said,’
- (36) Ga basa naa huu au daa de henua, gai gidaadeu ga daa.
 PRSP talk MED when 1SG turn.sharply DET island then 1PL.INCL PRSP turn.sharply
 ‘When I say turn to the island, then we’ll turn.’

- (37) Gai gilaadeu ga hulo huu ga tae gi Boonibei, gai e tuu iho donu
 then 3PL PRSP go.PL when PRSP reach.PL to Pohnpei then IPFV stand down EMPH
 dangada be ni loa ligi.
 person if COP.PL ant small/many
 'But when they came and arrived at Pohnpei, there were people standing there, as many
 as a colony of ants.'
- (38) Gai a Vave ga hai ange ga daa.
 then PN Vave PRSP say DIR.DIST PRSP turn.sharply
 'Then Vave ordered to turn.'
- (39) Agai a Deaguvae ga hai ange.
 then PN Deaguvae PRSP say DIR.DIST
 'And Deaguvae said,'
- (40) Au e madagu bei ni loa ligi.
 1SG IPFV afraid like COP.PL ant small
 'I am afraid, because there are many like ants.'
- (41) Agai gilaadeu ga sigi ga hulo.
 then 3PL PRSP tack PRSP go.PL
 'So they shifted their course and left.'
- (42) Gai ga sigi huu gilaadeu ga hulo, ga hulo gi Oneabu.
 then PRSP tack when 3PL PRSP go.PL PRSP go.PL to Oneop
 'So when they shifted their course and left, they went to Oneop.'
- (43) Ga tau huu i Oneabu gai a Vave ga hai ange.
 PRSP arrive.PL when PREP Oneop then PN Vave PRSP say DIR.DIST
 'So when they arrived at Oneop, Vave said,'
- (44) Ga daa. Gai Deaguvae ga hai ange, De kaba.
 PRSP turn.sharply then Deaguvae PRSP say DIR.DIST wait
 'Turn. And Deaguvae said, wait.'

- (45) Gai gilaadeu ga loo-age gu paa i uda ga daa ai dangada tee
 then 3PL PRSP come.PL-up INC touch.PL PREP inland PRSP kill OBL person PFV.NEG
 odi i de daa.
 empty PREP DET kill
 ‘So they came up and landed on shore, and they killed the people, but they were not able
 to kill them all.’
- (46) E hanu momo dangada e doe.
 IPFV some few person IPFV remain
 ‘There were a few people left.’
- (47) Gai ga malanga huu d-ono moni ga hano, gai ia ga ... gai dangada
 then PRSP depart when DET-3SG.GEN.O canoe PRSP go.SG then 3SG PRSP then person
 i dangada e doe i de henua laa ga hulo ga saabai mai de
 PREP person IPFV remain PREP DET island DIST PRSP go.PL PRSP carry DIR.PROX DET
 gau madumaadua hugadoo, ga gaa-mai gi helau-a tuulanga o
 people old.PL.RED above.all PRSP bring-DIR.PROX SBJV sorcery-CIA DET.place GEN.O
 de moni o de ama.
 DET canoe GEN.O DET outrigger.float
 ‘And when his canoe left, he... the people that remained on the island went and carried
 the oldest people, and brought them to do sorcery at the place of the canoe, of the float.’
- (48) De gau madumaadua ga helau ga gaav-ange de labodo gi lote
 DET people old.PL.RED PRSP sorcery PRSP give-DIR.DIST DET eel to inside.DET
 ama.
 outrigger.float
 ‘The elders did magic and put an eel inside the outrigger float.’
- (49) Gilaadeu ga hulo ai loo.
 3PL PRSP go.PL OBL EMPH
 ‘And so, they left.’
- (50) Go lu-aana damaa hine, ma lu-oolaau bodu, ma hanu
 COP.FOC DET.DU-3SG.GEN.A child woman and DET.DU-3SG.GEN.O spouse and some
 dangada ange i de-laadeu moni gilaadeu gu aahe.
 person DIR.DIST PREP DET-3PL.GEN canoe 3PL INC return.PL
 ‘So his two daughters, and their husband, and some other people on their canoe, they
 returned.’

- (51) Gilaadeu ga hulo hulo huu gu dee maua donu gi dau henua.
 3PL PRSP go.PL go.PL when INC NEG be.able EMPH to arrive island
 ‘As they sailed and sailed, they weren’t able to find land.’
- (52) Dai baa age gu sula de henua gu aahe ga hulo gi de moana
 almost be.close up INC be.sighted DET island INC return.PL PRSP go.PL to DET open.sea
 dai baa age gu sula de henua gu aahe ga hulo gi de moana.
 almost near up INC be.sighted DET island INC return.PL PRSP go.PL to DET open.sea
 ‘They would get almost close enough to see an island, and they would return to the open sea, and they would get almost close enough to see an island, they would return back to the open sea.’
- (53) Gai a Vave ga hai ange gi d-ana damaa hine gauligi,
 then PN Vave PRSP say DIR.DIST to DET-3SG.GEN.A child woman young
 ‘So Vave said to his younger daughter,’
- (54) Hai ange muhuu gi d-oo bodu, ia gi dalabaadaa ange be gu
 say DIR.DIST please to DET-2SG.GEN spouse 3SG SBJV divine DIR.DIST COMP.INT INC
 aha nei huu gu mmule ai nei huu de sula de henua.
 what PROX when INC slow OBL PROX when DET be.sighted DET island
 ‘Please ask your husband to do an oracle to see why we have been so slow to find an island.’
- (55) Agai d-ana damaa hine gauligi ga hai ange gi d-ono bodu,
 then DET-3SG.GEN.A child woman child PRSP say DIR.DIST to DET-3SG.GEN.O spouse
 ‘So his younger daughter told her husband,’
- (56) Bolo i d-ogu damana, koe gi dalabaadaa ange muhuu, be gu aha
 COMP PREP DET-1SG.GEN.O father 2SG SBJV divine DIR.DIST please if INC what
 gu mmule ai nei de sula de henua.
 INC slow OBL PROX DET be.sighted DET island
 ‘According to my father, you should please do an oracle to see why we have been so slow to find an island.’
- (57) Agai taane laa ga buubuu. Buubuu huu e hai ange d-ana
 then DET.man DIST PRSP divination divination when IPFV say DIR.DIST DET-3SG.GEN.A
 buubuu.
 divination
 ‘So that man did his magic. The magic told him his divination.’

- (58) Ga magau naa huu a Vave, gai de gau de moni gu odi i de tau.
 PRSP die IRR when PN Vave then DET people DET canoe INC empty PREP DET arrive.PL
 'If Vave dies, everyone else on the canoe will arrive.'
- (59) Agai ga dee magau naa huu a Vave, gai de gau de moni e odi de
 then PRSP NEG die IRR when PN Vave then DET people DET canoe IPFV empty DET
 maakau.
 die.PL
 'But if Vave doesn't die, everyone else on the canoe will die.'
- (60) Gai taane laa gu madagu i de tala ange gi d-ono bodu.
 then DET.man DIST INC afraid PREP DET tell DIR.DIST to DET-3SG.GEN.O spouse
 'So the man was afraid to tell his wife about it.'
- (61) Gai ia ga noho ai huu.
 then 3SG PRSP stay OBL when
 'So he stayed quiet for some time.'
- (62) Noho noho huu gai d-ono damana ga hai ange,
 stay stay when then DET-3SG.GEN.O father PRSP say DIR.DIST
 'He stayed quiet for a while, and his father said,'
- (63) Tigi dalabaadaa ange naa loo d-oo bodu?
 not.yet divine DIR.DIST IRR EMPH DET-2SG.GEN.O spouse
 'Has your husband not yet done the divination?'
- (64) Agai d-ana damaa hine ga hai ange, Tigi ai.
 then DET-3SG.GEN.A child woman PRSP say DIR.DIST not.yet OBL
 'And his daughter said, Not yet.'
- (65) Tigi hai mai nei.
 not.yet say DIR.PROX PROX
 'He hasn't told me yet.'

- (66) Gai gilaadeu ga deledele saele ai donu huu laa de moana ga deledele saele
 then 3PL PRSP sail.RED around OBL only DIST DET open.sea PRSP sail.RED around
 ai, ga deledele dele huu dahi laangi, gai a Vave ga galo ange huu gi
 OBL PRSP sail.RED sail when one day then then PN Vave PRSP look DIR.DIST when
 tamaa hine a d-ana damaa hine ga maileele nei donu.
 to DET.child woman GEN.A DET-3SG.GEN.A child woman PRSP die PROX EMPH
 ‘So they continued sailing around the open sea, and sailed and sailed and sailed, and fi-
 nally one day, Vave saw that his granddaughter was going to die.’
- (67) Gu hieunu. Gai ia ga hai ange gi d-ana damaa hine,
 INC thirsty then 3SG PRSP say DIR.DIST to DET-3SG.GEN.A child woman
 ‘She was thirsty. So he said to his daughter.’
- (68) Ni aha d-oo bodu gu mmule ai naa huu talabaadaa.
 COP.PL what DET-2SG.GEN.O spouse INC slow OBL IRR when DET.divine
 ‘Why is your husband so slow to do the oracle?’
- (69) Hai ange ia gi dalabaadaa gi moolau gai au ga tilo gidaadeu be
 say DIR.DIST 3SG SBJV divine SBJV quickly then 1SG PRSP look 1PL.INCL COMP.INT
 dehee taadeu hai e hai ai.
 which DET.1PL.INCL do IPFV do OBL
 ‘Tell him to do the oracle right away so I can decide what we should do.’
- (70) Gai tamaa hine a Vave ga hai ange gi d-ono bodu,
 then DET.child woman GEN.A Vave PRSP say DIR.DIST to DET-3SG.GEN.O spouse
 ‘So Vave’s daughter said to her husband,’
- (71) Bolo i d-ogu damana, koe gi buubuu gi moolau be gu aha
 COMP PREP DET-1SG.GEN.O father 2SG SBJV divination SBJV quickly COMP.INT INC what
 nei gu mmule ai nei taadeu d-au henua.
 PROX INC slow OBL PROX DET-1PL.INCL arrive island
 ‘According to my father, you need to do the divination right away to see why we are so
 slow to reach land.’
- (72) Gai taane laa ga hai ange,
 then DET.man DIST PRSP say DIR.DIST
 ‘And the man said,’

- (73) Au gu iloo odiodi gai au e madagu i a Vave i de tala adu.
 1SG INC know empty.RED then 1SG IPFV afraid PREP PN Vave PREP DET tell DIR.MED
 ‘I knew it a while ago, but I was too afraid of Vave to tell you.’
- (74) Gai d-ana damaa hine ga hai ange, Daalaa mai.
 then DET-3SG.GEN.A child woman PRSP say DIR.DIST tell.CIA DIR.PROX
 ‘And the daughter said, Tell me.’
- (75) Gai ia ga hai ange bolo i d-agu buubuu, ga magau naa huu a
 then 3SG PRSP say DIR.DIST COMP PREP DET-1SG.GEN.A PRSP die IRR when PN Vave
 Vave, gai gidaadeu gu tau.
 then 1PL.INCL INC arrive.PL
 ‘So he said, According to my divination, if Vave dies, we will reach land.’
- (76) Gai ga maakau naa huu gidaadeu ga odi, gai a Vave sogosogo ga dau.
 then PRSP die.PL IRR when 1PL.INCL PRSP empty then PN Vave alone PRSP arrive
 ‘And if we all die, Vave alone will reach land.’
- (77) Gai de ahiahi laa, gai ia ga hai ange gi d-ono damana.
 then DET evening DIST then 3SG PRSP say DIR.DIST to DET-3SG.GEN.O father
 ‘So that evening, she told her father.’
- (78) Gu hai mai nei loo d-ogu bodu bolo gu lava loo d-ono
 INC say DIR.PROX PROX EMPH DET-1SG.GEN.O spouse COMP INC finish EMPH DET-3SG.GEN.O
 dalabaadaa ange.
 divination DIR.DIST
 ‘My husband told me that he finished doing his oracle.’
- (79) Bolo e aha?
 COMP IPFV what
 ‘What did he say?’
- (80) Bolo ga magau naa huu goe, gimaadeu gu tau, gai ga mouli naa huu goe,
 COMP PRSP die MED when 2SG 1PL.EXCL INC arrive.PL then PRSP live IRR when 2SG
 gai gimaadeu gu odi de maakau.
 then 1PL.EXCL INC empty DET die.PL
 ‘He said that if you die, we will all reach land, but if you live, we will all die.’

- (81) Sala-ia doo senga. Mmule d-oo basa.
 mistake.CIA DET-2SG.GEN.O crazy slow DET-2SG.GEN talk
 ‘You fool. Why did you tell me so late?’
- (82) Boo taiao naa huu, ga sula age de laa, e lua laa e
 night DET.morning IRR when PRSP be.sighted up DET DIST IPFV two DIST IPFV
 ssula.
 be.sighted.PL
 ‘Tomorrow morning, when the sun rises, two suns will rise.’
- (83) Gai dahi laa e dahi mee e dagodo i ono lodo.
 then one DIST IPFV one thing IPFV lay PREP 3SG.GEN.O inside
 ‘And one of the suns will have something in the middle of it.’
- (84) Gai ga hu-mai naa ... ga hu-mai naa huu de laa laa,
 then PRSP come.SG-DIR.PROX IRR PRSP come.SG-DIR.PROX IRR when DET sun DIST
 luu laa laa, gai gidaadeu ga tilo be se aha e hu-mai.
 DET.DU sun DIST then 1PL.INCL PRSP look COMP.INT COP.SG what IPFV come.SG-DIR.PROX
 ‘And when that sun comes, those two suns, we will see what is coming.’
- (85) Gai gilaadeu ga nnoho ai loo.
 then 3PL PRSP stay.PL OBL EMPH
 ‘So they waited there.’
- (86) Sseni i de boo laa, ga aho age, ssula age e lua laa i
 sleep.PL PREP DET night DIST PRSP next.morning up be.sighted.PL up IPFV two DIST PREP
 hongai tai.
 top DET.sea
 ‘They slept that night, and the next morning, two suns appeared on the sea.’
- (87) E dahi laa e dahi mee i ono lodo.
 IPFV one DIST IPFV one thing PREP 3SG.GEN.O inside
 ‘One of the suns had something inside of it.’

- (88) Ga han-age han-age huu gu dee maeva dahi luu laa gai de laa i
 PRSP go.SG-up go.SG-up when INC NEG move.around one DET.DU sun then DET DIST PREP
 ono lodo laa de mee, e hu-mai laa hongai tai.
 3SG.GEN.O inside DIST DET thing IPFV come.SG-DIR.PROX DIST top DET.sea
 ‘As the suns rose, one of the two suns disappeared, and the sun that had something in it
 continued to come toward them on the sea.’
- (89) Ga hu-mai huu se daholaa.
 PRSP come.SG-DIR.PROX when COP.SG whale
 ‘It was a whale that was coming toward them.’
- (90) Ga hu-mai ga dagodo i magavaa luu giado maadua.
 PRSP come.SG-DIR.PROX PRSP lay PREP between DET.DU outrigger.boom old.PL
 ‘The whale came and lay between the two outrigger booms.’
- (91) Gai ia ga hai ange,
 then 3SG PRSP say DIR.DIST
 ‘And he said,’
- (92) Ga iho nei loo au e hano gi lote daholaa, e dagodo ai, gai gooluu
 PRSP down PROX EMPH 1SG IPFV go.SG to inside.DET whale IPFV lay OBL then 2DU
 ga hua mai ogu hagamubudubu, gai au ga hano.
 PRSP sing DIR.PROX 1SG.GEN praise then 1SG PRSP go.SG
 ‘I’m going to get down and to go into the whale, and lay there, and you two will sing
 praises to me, then I will leave.’
- (93) Gai ga iho huu delaau damana gi magavaa luu giado, gai ia
 then PRSP down when DET-3DU.GEN father to between DET.DU outrigger.boom then 3SG
 ga hai ange,
 PRSP say DIR.DIST
 ‘And when their father went down between the two outrigger booms, he said,’
- (94) Gooluu huudia mai ogu hagamubudubu.
 2DU sing.CIA DIR.PROX 1SG.GEN praises
 ‘You two, sing praises to me.’
- (95) Agai d-ana damaa hine gauligi ga hai ange,
 then DET-3SG.GEN.A child woman child PRSP say DIR.DIST
 ‘So his younger daughter said,’

- (96) Au ga dagudagu adu nei dengaa gubu o de manu.
 1SG PRSP say.RED DIR.MED PROX DET.PL.SUP part GEN.O DET tree
 'I will recite the parts of the tree.'
- (97) Gai koe ga haga-llongo.
 then 2SG PRSP CAUS-hear
 'Then you will listen.'
- (98) Agai d-ana damaa hine ... luaana damaa hine ga dagudagu
 then DET-3SG.GEN.A child woman DET.DU-3SG.GEN.A child woman PRSP say.RED
 ange denga gubu o de manu.
 DIR.DIST DET.PL part GEN.O DET tree
 'So his daughter ... his two daughters recited the parts of the tree.'
- (99) Ga lava huu tagudagu ange gai ia ga paa luu lima ga dangi
 PRSP finish when DET.say.RED DIR.DIST then 3SG PRSP touch.PL DET.DU hand PRSP cry
 ga hai ange gi luaana damaa hine,
 PRSP say DIR.DIST to DET.DU-3SG.GEN.A child woman
 'And when they finished saying these things, he clapped his hands and cried and said to his two daughters.'
- (100) E tonu hugadoo gooluu i d-ogu maagoda.
 IPFV correct.PL above.all 2DU PREP DET-1SG.GEN.O jealous
 'You two are worthy of my jealousy.'
- (101) Gai ia ga haga-doo ange gi lote daholaa.
 then 3SG PRSP CAUS-fall DIR.DIST to inside.DET whale
 'So he dropped down inside of the whale.'
- (102) Gai ia ga basa ange ga hai ange,
 then 3SG PRSP talk DIR.DIST PRSP say DIR.DIST
 'And he spoke and said.'
- (103) Ga dolu naa huu boo, gai gu pasa adu dangada.
 PRSP three IRR when night then INC talk.PL DIR.MED person
 'After three nights, the people will talk to you.'

- (104) Gu dau loo e dahi odaoda i dua Tuudanga de-laa tee madea
 INC arrive EMPH IPFV one driftwood PREP back Tuudanga DET-DIST PFV.NEG recognize
 donu ma taholaa.
 EMPH and DET.whale
 ‘A log will have washed up on the ocean side of Tuudanga, looking no different than a whale.’
- (105) E bei donu taholaa.
 IPFV like EMPH DET.whale
 ‘It will look like the whale.’
- (106) Gai koe ga hano gi ngaadai Saavae, ga hhuge mai seisei.
 then 2SG PRSP go.SG to lagoon.side Saavae PRSP uncover DIR.PROX pipefish
 ‘So you will go to the lagoon side of Saavae, and dig up the pipefish and bring it over.’
- (107) Ga gaa-mai ga duuduu ai de angaanga o d-au dama sia ssiisii
 PRSP bring-DIR.PROX PRSP cut.RED OBL DET body GEN.O DET-2SG.GEN.A child ?? ??
 e valu.
 IPFV eight
 ‘Bring it and cut the body of your child... (??).’
- (108) Ga lava huu, koe ga haga-ahe seisei ga danu i ngaadai Saavae.
 PRSP finish when 2SG PRSP CAUS-return pipefish PRSP bury PREP lagoon.side Saavae
 ‘When you’re done, you will bring back the pipefish and bury it on the lagoon side of Saavae.’
- (109) Gai gooluu ga hulo gi dua Tuudanga.
 then 2DU PRSP go.PL to back Tuudanga
 ‘And you will go to the ocean-side of Tuudanga.’
- (110) Ga loo-adu naa huu gooluu de henua alodahi e tuu hugadoo ma e
 PRSP come.PL-DIR.MED IRR when 2DU DET island all IPFV cut all and IPFV
 tilo de mamu i dua Tuudanga.
 look DET fish PREP back Tuudange
 ‘When you arrive there, the whole island will stand and look at the fish at the ocean-side of Tuudanga.’

- (111) Gai koe ga han-adu ga gaav-adu dau dama haga-duu i
 then 2SG PRSP go.SG-DIR.MED PRSP give-DIR.MED DET-2SG.GEN.A child CAUS-stand PREP
 ssugi manga-lua, ga haga-pigi ange agina luu lima ga dugu.
 DET.tail branch-two PRSP CAUS-attach DIR.DIST there DET.DU hand PRSP put
 ‘And you will go and bring your child and stand him at the branching tail (of the whale)
 and put his hands on it and leave him there.’
- (112) Gai ga malanga... gai ga dugu-a naa huu e goe, gai de mamu laa ga
 then PRSP depart then PRSP put-CIA IRR when ERG 2SG then DET fish DIST PRSP
 malanga ga hano laa lote moana.
 depart PRSP go.SG DIST inside.DET open.sea
 ‘And it will depart... when you leave him there, that fish will depart and go into the open
 ocean.’
- (113) Ga hano naa donu huu ga dae gi tua de beau gai ia ga haga-lilo
 PRSP go.SG IRR only PRSP reach to DET.back DET wave then 3SG PRSP CAUS-disappear
 gi lalo gu hano.
 to below INC go.SG
 ‘And when it goes and it reaches behind the waves, it will disappear under the water and
 leave.’
- (114) Au gu kave d-au dama.
 1SG INC take DET-2SG.GEN child
 ‘I will take your child.’
- (115) Hano nei au e kave e dugu age i Dahidi.
 go.SG PROX 1SG IPFV take IPFV put up PREP Tahiti
 ‘I am going to take him to Tahiti.’
- (116) Gai d-ogu masavaa naa huu e hano ai, gai gooluu sui-a ai loo
 then DET-1SG.GEN.O time IRR when IPFV go.SG OBL then 2DU change-CIA OBL EMPH
 d-ogu ingoo.
 DET-1SG.GEN.O name
 ‘And when I leave, you two change my name.’
- (117) Au gu dee go Vave. Au go Samouli daane.
 1SG INC NEG COP.FOC Vave 1SG COP.FOC Samouli man
 ‘I am no longer Vave. I am Samouli daane.’

- (118) De-naa d-ogu ingoo ooluu e sui go Samouli daane.
 DET-MED DET-1SG.GEN.O name 2DU.GEN IPFV change COP.FOC Samouli man
 ‘That is my name that you will change, Samouli daane.’
- (119) Gai goodou, ga dagudagu donu huu bolo go Samouli daane.
 then 2PL PRSP say.RED only COMP COP.FOC Samouli daane
 ‘You all will only say Samouli daane.’
- (120) Gai noo gooluu gu aahe ange e hagataba bolo go Vave, gai au e
 then if 2DU INC return.PL DIR.DIST IPFV say COMP COP.FOC Vave then 1SG IPFV
 hu-mai gi gooluu.
 come.SG-DIR.PROX to 2DU
 ‘And if you return and say that it’s Vave, I will come to you.’
- (121) Gai lu-aana damaa hine, ga aahe mai ai loo.
 then DET.DU-3SG.GEN.A child woman PRSP return.PL DIR.PROX OBL EMPH
 ‘And so his two daughters returned.’
- (122) Gai ia ga hai ange.
 then 3SG PRSP say DIR.DIST
 ‘And he said to them,’
- (123) Gai au ga tuu ai naa loo de vai henua.
 then 1SG PRSP cut OBL MED EMPH DET water island
 ‘I will stop the water of the island.’²
- (124) Ga sui naa huu d-ogu ingoo go au go Samoulidaane, gai
 PRSP change IRR when DET-1SG.GEN.O name COP.FOC 1SG COP.FOC Samoulidaane then
 au ga tuu de vai henua.
 1SG PRSP cut DET water island
 ‘When you change my name to Samoulidaane, I will stop the water of the island.’
- (125) Ga duu-dia naa huu au de vai henua, gai goodou gu dee iloo de hulo gi
 PRSP cut-CIA IRR when 1SG DET water island then 2PL INC NEG know DET go.PL to
 denga henua.
 DET.PL island
 ‘When I stop the water of the island, you will not be able to go to other islands.’

²Alternatively, *de vai henua* could be interpreted here as the name of a location on the main islet, *Devaihenua*.

- (126) Gai au ga ahe naa huu, ga ahe gi Dahidi.
 then 1SG PRSP return IRR when PRSP return to Tahiti
 ‘Then I will go back and return to Tahiti.’
- (127) Kave d-au dama agina, go ia, iai ssui o d-agu dama,
 take DET-2SG.GEN child there COP.FOC 3SG has DET.replace GEN.O DET-1SG.GEN.A child
 ne magau laa i Dahidi.
 PFV die DIST PREP Tahiti
 ‘Take your child there, for he is to replace my son, who died in Tahiti.’
- (128) De-naa donu taadeu henua donu bei Saamoa go Dahidi.
 DET-MED EMPH DET.1PL.INCL island EMPH like Samoa COP.FOC Tahiti
 ‘Tahiti is one of our islands, like Samoa.’
- (129) Agai denga henua angeange laa, e tee noho ai loo au, agai au se
 then DET.PL island other DIST IPFV PFV.NEG live OBL EMPH 1SG then 1SG COP.SG
 daa donu huu.
 turn.sharply only
 ‘And those other islands, I didn’t stay there, I just passed by them.’
- (130) De-laa e pasa ai laa bei gidaadeu i Saamoa.
 DET-DIST IPFV talk.PL OBL DIST like 1PL.INCL PREP Samoa
 ‘That’s why they talk like us in Samoa.’
- (131) Agai Dahidi, go ssui donu o Saamoa.
 then Tahiti COP.FOC replace EMPH GEN.O Samoa
 ‘And Tahiti is the same as Samoa to us.’
- (132) Gai lu-aana damaa hine, ga aahe mai ai loo, gi de momme
 then DET.DU-3SG.GEN.A child woman PRSP return.PL DIR.PROX OBL EMPH to DET place
 e haga-ingoo ange laa, bolo go dua Devaihenua ga nnoho ai.
 IPFV CAUS-name DIR.DIST DIST COMP COP.FOC back Devaihenua PRSP live.PL OBL
 ‘And so his two daughters returned to the place called Devaihenua, and they lived there.’
- (133) De-laa donu, de-laadeu momme nnoho, i de laa tubua mau.
 DET-DIST EMPH DET-3PL.GEN place live.PL PREP DET every.day.duties usual
 ‘So that is where they stayed thereafter.’

A.10 Taalanga o Vave (12-1) – Haini

Speaker: Haini

Date recorded: Spring 1966

Location: Nukuoro Atoll, Pohnpei State, Federated States of Micronesia

Recording information: Reel 12, story 1

Haini tells the story of Gaeuli's discovery of Nukuoro Atoll, and Vave's attempt to avenge the death of his son, Iaidemalo. After being cursed by the people of Oneop, who conjure an eel in their canoe, Vave sacrifices himself and becomes a whale; his children fail to do as he tells them when they return to Nukuoro.

- (1) E dahi daane Saamoa, d-ono ingoo go Gaeuli.
 IPFV one man Samoa DET-3SG.GEN.O name COP.FOC Gaeuli
 'There was a Samoan man whose name was Gaeuli.'
- (2) Gai ia ga malanga i Saamoa, ga hagadaga mai denga henua,
 then 3SG PRSP depart PREP Samoa PRSP go.from.one.to.other DIR.PROX DET.PL island
 se hu-mai e sala henua.
 COP.SG come.SG-DIR.PROX IPFV search.for island
 'He set sail from Samoa, and sailed to several islands, he came to look for islands.'
- (3) Gai ia ga hu-mai hu-mai hu-mai hu-mai
 then 3SG PRSP come.SG-DIR.PROX come.SG-DIR.PROX come.SG-DIR.PROX come.SG-DIR.PROX
 hu-mai, hu-mai gu dae mai gi de henua nei.
 come.SG-DIR.PROX come.SG-DIR.PROX INC reach DIR.PROX to DET island PROX
 'So he sailed and sailed and sailed and he landed on this island.'
- (4) Gu dae mai gi dua Dagamanga, gai ia ga tili d-ono uga,
 INC reach DIR.PROX to back Dagamanga then 3SG PRSP throw DET-3SG.GEN.O fishing.line
 ga hhudi age e dahi libo.
 PRSP pull up IPFV one jack
 'He reached the ocean-side of Dagamanga, and he threw his fishing line and pulled in a jack.'

- (5) Gai ia ga gaa-mai ga hu-mai ai ga hu-mai ga
 then 3SG PRSP bring-DIR.PROX PRSP come.SG-DIR.PROX OBL PRSP come.SG-DIR.PROX PRSP
 hano iho gi dai, gai ia ga han-age gi dai Langiasa.
 go.SG down to lagoon then 3SG PRSP go.SG-up to lagoon Langiasa
 'So he took it and came and came and went into the lagoon, and he went ashore on the
 lagoon-side of Langiasa.'
- (6) Gai ia ga nnoa d-ono moni, gai ia ga han-age ga dahu
 then 3SG PRSP tie DET-3SG.GEN.O canoe then 3SG PRSP go.SG-up PRSP start.fire
 d-ana ahi e dunu ai d-ana libo.
 DET-3SG.GEN.A fire IPFV cook OBL DET-3SG.GEN.A jack
 'So he tied his canoe, and went ashore and started his fire to cook his jack.'
- (7) Ga han-age ga dahu de ahi, gai tigi gaa donu de ahi ga galo adu
 PRSP go.SG-up PRSP start.fire DET fire then not.yet burn EMPH DET fire PRSP look DIR.MED
 gu ma-dala de moni, gai ia ga savini iho, ga nnoa, gai ia ga ahe
 INC STAT-untie DET canoe then 3SG PRSP run down PRSP tie then 3SG PRSP return
 age.
 up
 'He went and started his fire, but before it even started burning, he saw that his canoe
 was untied, so he ran down, tied it, and came back up.'
- (8) Dahu d-ana ahi.
 start.fire DET-3SG.GEN.A fire
 'And started his fire.'
- (9) Noho noho ange e dee dau looloa donu ga galo adu gu ma-dala de
 sit sit DIR.DIST IPFV NEG fasten long EMPH PRSP look DIR.MED INC STAT-untie DET
 moni, gai ia ga ahe iho.
 canoe so 3SG PRSP return down
 'He wasn't there long when he saw that his canoe was untied, so he went back down.'
- (10) E lima be ono hanonga ne hai ai be nei, mmoa d-ana mamu, agai ia
 IPFV five or six iteration PFV do OBL like PROX cooked DET-3SG.GEN.A fish then 3SG
 ga hano iho huu gai ia ga maanadu age,
 PRSP go.SG down when so 3SG PRSP think up
 'Five or six times it happened like this, his fish was cooked, and he went back and thought.'

- (11) E dee iloo de noho i kinei. Hakoso de henua nei.
 IPFV NEG know DET live PREP here CAUS.bother DET island PROX
 ‘I can’t stay here. This island is so disturbing.’
- (12) Dee iloo donu be se aha de-nei e hai-a nei be nei.
 NEG know EMPH COMP.INT COP.SG what DET-PROX IPFV do-CIA PROX if PROX
 ‘I don’t understand what is doing this to me.’
- (13) Ga ahe nei donu au, ga tala ange gi a Vave.
 PRSP return PROX EMPH 1SG PRSP tell DIR.DIST to PN Vave
 ‘I will return and tell Vave.’
- (14) Agai gilaadeu ga aahe mai, ga tilo ai be dehee tulagi.
 so 3PL PRSP return.PL DIR.PROX PRSP look OBL COMP.INT which DET.appear
 ‘And they will return, to see what it’s like.’
- (15) Gai ia ga hano ai loo.
 then 3SG PRSP go.SG OBL EMPH
 ‘So he left.’
- (16) Gai ia ga hano huu, ga hano gu dae.
 then 3SG PRSP go.SG when PRSP go.SG INC reach
 ‘And so he returned and reached (Samoa).’
- (17) Tala ange gi a Vave, gai a Vave ga hai ange,
 tell DIR.DIST to PN Vave then PN Vave PRSP say DIR.DIST
 ‘He told Vave, and Vave said.’
- (18) Loo-age loo gidaadeu. Agai gilaadeu ga malanga ga loo-mai.
 come.PL-up EMPH 1PL.INCL then 3PL PRSP depart PRSP come.PL-DIR.PROX
 ‘Let’s go up then. And so they departed and came.’
- (19) Loo-mai loo-mai loo-mai, gu sula de henua nei.
 come.PL-DIR.PROX come.PL-DIR.PROX INC appear DET island PROX
 ‘Came and came, and the island appeared.’
- (20) Gilaadeu ga loo-mai, loo-mai ga nnoho.
 3PL PRSP come.PL-DIR.PROX come.PL-DIR.PROX PRSP live.PL
 ‘So they came, came and settled there.’

- (21) Gilaadeu ga nnoho nnoho nnoho huu, gai a Sogo ga gaa-mai ono
 3PL PRSP live.PL live.PL live.PL when then PN Sogo PRSP bring-DIR.PROX 3SG.GEN.O
 daane ga loo-mai.
 man PRSP come.PL
 ‘So as they stayed and stayed, Sogo brought his men and came.’
- (22) Ga pasa gilaadeu, dee iloo ingoo denga daane, denga eidu o Sogo, ma
 PRSP talk.PL 3PL NEG know name DET.PL man DET.PL ghost GEN.O Sogo and
 dangada o tangada nei.
 person GEN.O DET.person PROX
 ‘And they talked, I don’t know the names of those men, the ghosts of Sogo, and the people
 of this man.’
- (23) Dee iloo loo e au de tala adu dangada nei.
 NEG know EMPH IPFV 1SG DET tell DIR.MED person PROX
 ‘I can’t tell you the names of these people.’
- (24) Gai gilaadeu ga hai taudau.
 then 3PL PRSP do DET.wrestle
 ‘And so they wrestled.’
- (25) Ga daudau huu, gu kii denga daane o Vave.
 PRSP wrestle when INC won DET.PL man GEN.O Vave
 ‘When they wrestled, Vave’s men won.’
- (26) Agai a Sogo gu dogaa.
 then PN Sogo INC ashamed
 ‘And Sogo was humiliated.’
- (27) Gai ia ga taa ana gelegele gi lot-ana laulau, ga hano
 then 3SG PRSP scoop 3SG.GEN.A sand to inside.DET-3sg.gen.a food.basket PRSP go.SG
 ai.
 OBL
 ‘So he scooped up his sand into his basket, and he left.’
- (28) Agai denga gelegele ga malili.
 then DET.PL sand PRSP scatter
 ‘And then the sand leaked out.’

- (29) Ga hano ai ga hano, de-naa ai ga malili ai naa, ga tuu denga modu
 PRSP go.SG OBL PRSP go.SG DET-MED OBL PRSP scatter OBL MED PRSP stand.PL DET.PL islet
 e hagatau naa gi ngaiho.
 IPFV arrange.in.order MED to north
 'He took it and left, and so, as it leaked out, it formed the islands that line up to the north.'
- (30) Agai tangada nei gu noho ai loo a Vave.
 then DET.person PROX INC live OBL EMPH PN Vave
 'Then this man, Vave stayed there.'
- (31) Gai gilaadeu ga nnoho nnoho nnoho huu, gu dau looloa donu de-laadeu nnoho
 then 3PL PRSP live.PL live.PL live.PL when INC fasten long EMPH DET-3PL.GEN live.PL
 i de henua.
 PREP DET island
 'So they stayed and stayed there, and they lived on the island for a long time.'
- (32) Agai e dahi dangada ga haga-ago luu daagami gi loo-mai gi velosia
 then IPFV one person PRSP CAUS-learn DET.DU guard to come.PL-DIR.PROX to stab.CIA
 a Logo.
 PN Logo
 'Then someone instructed two guards to come and stab Logo.'
- (33) Go de bodu o laidemalo.
 COP.FOC DET spouse GEN.O laidemalo
 'The wife of laidemalo.'
- (34) Gai gilaadeu ga ... de gau laa ga loo-mai e velo.
 then 3PL PRSP DET people DIST PRSP come.PL-DIR.PROX IPFV stab
 'So they... those people went to stab him.'
- (35) Gu langona e de gau nei, agai gilaadeu ga dada de oo.
 INC hear ERG DET people PROX then 3PL PRSP pull DET ration.of.taro
 'But they heard about it, so they picked a ration of taro.'
- (36) Gai ga lava huu de-laadeu dada de oo gai tangada nei ga
 then PRSP finish when DET-3PL.GEN pull DET ration.of.taro then DET.person PROX PRSP
 hagadaba age donu huu i d-ono ngudu,
 say up only PREP DET-3SG.GEN.O mouth
 'And after they picked their taro, this person said aloud,'

- (37) Henua o dangada, go... goe Leibua.
 island GEN.O person COP.FOC 2SG Leibua
 ‘On other people’s island, you are Leibua.’
- (38) Henua o dangada, goe Leibua.
 island GEN.O person 2SG Leibua
 ‘On other people’s island, you are Leibua.’
- (39) Gilaadeu ga dada de oo ga gaa-mai, ga lava ga malanga de
 3PL PRSP pull DET ration.of.taro PRSP bring-DIR.PROX PRSP finish PRSP depart DET
 moni, ga hulo.
 canoe PRSP go.PL
 ‘They pulled enough taro and brought it, and then they launched their canoe and left.’
- (40) Ga hano Iaidemalo.
 PRSP go.SG Iaidemalo
 ‘So Iaidemalo left.’
- (41) Gai ia ga hano ga hano hano huu ga hulo gilaadeu gu tae gi de henua
 then 3SG PRSP go.SG PRSP go.SG go.SG when PRSP go.PL 3PL INC reach.PL to DET island
 aagu e hai adu nei go Hidi.
 1SG.GEN.A IPFV say DIR.MED PROX COP.FOC Tahiti
 ‘So he left, and as they sailed, they reached the island that I am telling you about now,
 which is Tahiti.’
- (42) Agai de gau laa ga poo.
 so DET people DIST PRSP grab
 ‘And the people there captured them.’
- (43) Ga haga-duu e dahi laagau, ga nnoa i taula ga dada gi lunga.
 PRSP CAUS-stand IPFV one log PRSP tie PREP DET.rope PRSP pull to above
 ‘They erected a log, and they tied a rope to it and pulled it up.’
- (44) Gi ulu de laagau. Gai ga dabudabui ange hongade baba.
 to top DET log then PRSP splash.water.RED DIR.DIST top DET platform
 ‘To the top of the log. Then they splashed water on the platform.’

- (45) Gai de ahi ga ula age gai gilaadeu ga haga-sege iho gi lote ahi.
 then DET fire PRSP flame up so 3PL PRSP CAUS-slide down to inside.DET fire
 ‘And the fire flared up and they slid them down into the fire.’
- (46) Ga lava ga hhudi gi lunga.
 PRSP finish PRSP pull.PL to above
 ‘And then they pulled them up.’
- (47) Agai e dahi daane ange ga hu-mai i de masavaa nei.
 then IPFV one man DIR.DIST PRSP come.SG-DIR.PROX PREP DET time PROX
 ‘Then another man came at that time.’
- (48) Ga hu-mai i dua o Gaeuli. Ga hu-mai huu ia gu
 PRSP come.SG-DIR.PROX PREP back GEN.O Gaeuli PRSP come.SG-DIR.PROX when 3SG INC
 gidee
 see
 ‘He came after Gaeuli. And when he came, he saw’
- (49) tangada nei e hai be nei.
 DET.person PROX IPFV do like PROX
 ‘what they did to this person.’
- (50) Gai ia ga hu-mai huu ga dae mai gi de henua nei, gai ia
 then 3SG PRSP come.SG-DIR.PROX when PRSP reach DIR.PROX to DET island PROX so 3SG
 ga hu-mai hogi, ga hu-mai ga pasa ma Vave.
 PRSP come.SG-DIR.PROX also PRSP come.SG-DIR.PROX PRSP talk.PL with Vave
 ‘So when he came and arrived at this island, he came here also, he came and talked with
 Vave.’
- (51) Ia ga hu-mai gi daho Vave, ga noho i daho Vave, ga poo
 3SG PRSP come.SG-DIR.PROX to place.GEN Vave PRSP live PREP place.GEN Vave PRSP grab
 age luu lima o Vave, poo saele de angaanga o Vave, ga galo ange.
 up DET.DU hand GEN.O Vave grab around DET body GEN.O Vave PRSP look DIR.DIST
 ‘He came to where Vave was, and he stayed with Vave, and he touched Vave’s hands,
 touched all over Vave’s body, as he looked at it.’
- (52) Gai a Vave, Gu aha laa?
 then PN Vave INC what DIST
 ‘And Vave (asked), What is it?’

- (53) Gai de ... au ga hu-mai huu gi Hidi, gu gidee e dahi daane.
 then DET 1SG PRSP come.SG-DIR.PROX when to Tahiti INC see IPFV one man
 ‘And the (man replied), I came to Tahiti and I saw a man there.’
- (54) E laalaa-ngia i de gula i Hidi.
 IPFV roast-CIA PREP DET bonfire PREP Tahiti
 ‘Who was roasted on a fire in Tahiti.’
- (55) Ga dada gi lunga, ga haga-sege iho gi lote ula.
 PRSP pull to above PRSP CAUS-slide down to inside.DET flame
 ‘They lifted him up and slid him down into the flame.’
- (56) Ga dada gi lunga, ga haga-sege iho gi lote ula.
 PRSP pull to above PRSP CAUS-slide down to inside.DET flame
 ‘They lifted him up and slid him down into the flame.’
- (57) Au ga galo ange go koe donu huu.
 1SG PRSP see DIR.DIST COP.FOC 2SG EMPH when
 ‘He looked just like you.’
- (58) Ga lango-na huu e tangada laa de mee nei, ia gu aloha i
 PRSP hear-CIA when IPFV DET.person DIST DET thing PROX 3SG INC love PREP
 d-ana dama.
 DET-3SG.GEN.A child
 ‘When that man heard this, he was filled with love for his son.’
- (59) Gai ia ga hano nei e hano e tilo.
 then 3SG PRSP go.SG PROX IPFV go.SG IPFV look
 ‘So he left to go look for him.’
- (60) Gai ia ga kave d-ono bodu, ana dama, dangada o d-ono
 then 3SG PRSP take DET-3SG.GEN.O spouse 3SG.GEN.A child person GEN.O DET-3SG.GEN.O
 moni, ga hulo ai gilaadeu.
 canoe PRSP go.PL OBL 3PL
 ‘He took his wife, their children, the people on his canoe, and they all left.’
- (61) Ga hulo hulo hulo hulo gu tau i Oneabu.
 PRSP go.PL go.PL go.PL go.PL INC arrive.PL PREP Oneop
 ‘And they sailed and sailed and sailed and arrived at Oneop.’

- (62) Gai ga tau huu gilaadeu i Oneabu, ga malanga ga hulo, agai gu ngalo
 then PRSP arrive.PL when 3PL PREP Oneop PRSP depart PRSP go.PL then INC forget
 de kave de lango o de moni.
 DET take DET canoe.log GEN.O DET canoe
 ‘When they arrived at Oneop, they set sail again and left, but they forgot to take the log
 for the canoe.’
- (63) Agai de gau maadua ga loo-iho ga helau.
 then DET people old.PL PRSP come.PL-down PRSP sorcery
 ‘And the elders came down and did magic.’
- (64) Ga helau de lango, de labodo ga ulu gi lote ama de moni.
 PRSP sorcery DET canoe.log DET eel PRSP enter to inside.DET outrigger.float DET canoe
 ‘They turned the log of the canoe into an eel that went inside the outrigger float of the
 canoe.’
- (65) Gai gilaadeu gu maalanga ma gu hulo.
 so 3PL INC depart.PL and INC go.PL
 ‘So they set sail and left.’
- (66) Ga hulo huu, gu dee dau henua i dahi henua, ga hulo donu huu ga ssenga
 PRSP go.PL when INC NEG arrive island PREP one island PRSP go.PL only PRSP stupid
 saele laa de moana.
 around DIST DET open.sea
 ‘And as they sailed, they couldn’t land on any islands, they only sailed senselessly around
 on the open sea.’
- (67) Ga llodo e loo-age gi de henua, gidee de henua gai gu dee maua de
 PRSP want.PL IPFV come.PL-up to DET island see DET island so INC NEG be.able DET
 loo-age.
 come.PL-up
 ‘They wanted to land on the island, find the island, but they weren’t able to reach it.’
- (68) De labodo ga hano ga dada gee gai gilaadeu ga hulo hulo hulo hulo huu,
 DET eel PRSP go.SG PRSP pull away so 3PL PRSP go.PL go.PL go.PL go.PL when
 gu odi gai de moni.
 INC empty food DET canoe
 ‘The eel was pulling them away, so they sailed and sailed and sailed, and the food on their
 canoe ran out.’

- (69) Agai tangada laa ga buubuu ange. A Gaeuli.
 then DET.person DIST PRSP divine DIR.DIST PN Gaeuli
 ‘So that man did his divination. Gaeuli.’
- (70) Ga buubuu ange huu, ga magau naa Vave, gai gilaadeu ga tau.
 PRSP divine DIR.DIST when PRSP die IRR when then 3PL PRSP arrive.PL
 ‘As Gaeuli foretold it, when Vave died, they would reach land.’
- (71) Gai ga odi naa gilaadeu de maakau, gai a Vave ga dau sogosogo.
 then PRSP empty IRR 3PL DET die.PL then PN Vave PRSP arrive alone
 ‘But if they all died, Vave would reach land alone.’
- (72) Agai gu hai mee gaiaa i de tala ange, gi a Vave gu madagu.
 then INC do thing steal PREP DET tell DIR.DIST to PN Vave INC afraid
 ‘He was reluctant to tell Vave because he was afraid.’
- (73) Agai ia ga tala ange gi lu-oono bodu, dahi lu-oono bodu,
 then 3SG PRSP tell DIR.DIST to DET.DU-3SG.GEN.O spouse one DET.DU-3SG.GEN.O spouse
 dee iloo be go Gauna be go Hagalolo.
 NEG know if COP.FOC Gauna or COP.FOC Hagalolo
 ‘So he told his wives, one of his wives, I don’t know if it was Gauna or Hagalolo.’
- (74) Gai tamaa hine a Vave ga tala ange gi a Vave, gai a Vave,
 then DET.child woman GEN.A Vave PRSP tell DIR.DIST to PN Vave then PN Vave
 ‘And Vave’s daughter told Vave, and Vave (said),’
- (75) Kona d-oo senga.
 very DET-2SG.GEN.O stupid
 ‘You’re so stupid!’
- (76) Moolau naa d-au tala mai, dee de-nei loo odaadeu dagodo.
 quick/early IRR DET-2SG.GEN.A tell DIR.PROX NEG DET-PROX EMPH 1PL.INCL.O situation
 ‘If you had told me earlier, we wouldn’t be in this situation.’
- (77) Dee dua sala loo gidaadeu. Danuaa.
 NEG difficulty emph 1PL.INCL good
 ‘We won’t continue to have problems. It’s okay.’

- (78) Go au e magau gai goodou ga haga-ola. Ga hai ange,
 COP.FOC 1SG IPFV die then 2PL PRSP CAUS-save PRSP say DIR.DIST
 ‘I will die so you can be saved. And he said,’
- (79) Ga sobo age naa huu de laa i dua, ga kalo adu goodou e dahi mee
 PRSP rise up IRR when DET sun PREP back PRSP look.PL DIR.MED 2PL IPFV one thing
 i lote laa, gai ga hu-mai hu-mai hu-mai
 PREP inside.DET sun then PRSP come.SG-DIR.PROX come.SG-DIR.PROX come.SG-DIR.PROX
 naa huu ga soe mai gi lunga gai taholaa gu lui mai baasi
 IRR when PRSP straight DIR.PROX to above then DET.whale INC turn DIR.PROX side
 gadea de moni.
 non.outrigger DET canoe
 ‘When the sun rises in the east, you will see something inside the sun, and as it comes
 toward you, it will go straight up, and the whale will come to the flat side of the canoe.’
- (80) Gai goodou ga hua mai d-ogu hagadubudubu.
 then 2PL PRSP sing DIR.PROX DET-1SG.GEN.O praise
 ‘And you will sing my praises.’
- (81) Gai ga lava huu de hua ange a de gau laa de mee, gai ia ga
 then PRSP finish when DET sing DIR.DIST GEN.A DET thing DIST DET thing so 3SG PRSP
 haga-doo ange gi te mamu.
 CAUS-drop DIR.DIST to inside.DET fish
 ‘And when they finished singing those praises, he dropped down into the fish.’
- (82) Gai ia ga hai ange, Goodou gaav-age de gaadinga ma gi doo-a.
 then 3SG PRSP say DIR.DIST 2PL bring-up DET mature.coconut and SBJV plant-CIA
 ‘Then he said, you all, bring the mature coconut back with you and plant it.’
- (83) Boo ... ga lau valu naa huu de gaadinga, agai taholaa gu dau.
 night PRSP leaf eight IRR when DET mature.coconut then DET.whale INC arrive
 ‘And when the coconut has eight leaves, then the whale will arrive.’
- (84) Agai go tamaa gauligi huu i ana dama laa e hai ... e gava
 then COP.FOC DET.child young when PREP 3SG.GEN.A child DIST IPFV do IPFV cut.open
 ina taholaa.
 INA DET.whale
 ‘And it is my youngest grandchild who will cut open the whale.’

- (85) E dee go dahi goodou naa.
 IPFV NEG COP.FOC one 2PL MED
 'It will not be one of you.'
- (86) Agai ana dama ga hai ange bolo uaa.
 then 3SG.GEN.A child PRSP say DIR.DIST COMP yes
 'And his children said okay.'
- (87) Gilaadeu ga malanga ai loo, gai a Vave gu hano donu i taholaa.
 3PL PRSP set.sail OBL EMPH then PN Vave INC go.SG EMPH PREP DET.whale
 'So they set sail, and Vave was taken by the whale.'
- (88) Gai gilaadeu ga loo-mai. Gilaadeu ga loo-mai loo-mai
 then 3PL PRSP come.PL-DIR.PROX 3PL PRSP come.PL-DIR.PROX come.PL-DIR.PROX
 huu gu tau.
 when INC arrive.PL
 'Then they came. They sailed and sailed and they arrived.'
- (89) Tau i de henua. Gai gilaadeu ga doo de gaadinga.
 arrive.PL PREP DET island then 3PL PRSP drop DET mature.coconut
 'Arrived at the island. And they planted the mature coconut.'
- (90) Ga doo huu, gai de gaadinga laa ga somo, ga hano hano huu gu
 PRSP drop when then DET mature.coconut DIST PRSP grow PRSP go.SG go.SG when INC
 dae gi de lau valu.
 reach to DET leaf eight
 'When they planted it, the coconut grew, and it grew and grew until it had eight leaves.'
- (91) Agai taholaa gu dau. Gilaadeu ga loo-adu nei e hai.
 then DET.whale INC arrive 3PL PRSP come.PL-DIR.MED PROX IPFV do
 'Then the whale arrived. They went over to cut it open.'
- (92) Ga loo-adu huu, gai gilaadeu ga hai go tama go ... Vave
 PRSP come.PL-DIR.MED when then 3PL PRSP do COP.FOC DET.child COP.FOC Vave
 ... Deagu ... Deaguvaealigi bolo e hai-a taholaa.
 Deagu Deaguvaealigi COMP IPFV do-CIA DET.whale
 'When they went over, they made Vave's son Deagu, Deaguvaealigi cut open the whale.'

- (93) Agai tamana ga basa age,
then DET.father PRSP talk up
'And the father spoke and said,'
- (94) Gu aha gu hai gee ai naa goodou ma d-agu hai ne hai adu gi
INC what INC do away OBL IRR 2PL with DET-1SG.GEN.A way PFV say DIR.MED to
goodou?
2PL
'Why have you done away with what I have told you?'
- (95) Gu lava i d-agu hai adu gi goodou, de-nei tangada e hai-a
INC finish PREP DET-1SG.GEN.A say DIR.MED to 2PL DET-PROX DET.person IPFV do-CIA
agu ne haga-modu adu, gai gu aha gu hai gee ai naa ma d-agu
1SG.GEN PFV CAUS-stop DIR.MED then INC what INC do away OBL IRR with DET-1SG.GEN.A
muna?
word
'I already told you that this is the person that I commanded to do it, so why are you doing
away with my instructions?'
- (96) Agai ia gu haga-ahe gu hai ange bolo tama gauligi loo gu hai-a de
then 3SG INC CAUS-return INC say DIR.DIST COMP DET.child young EMPH INC do-CIA DET
mee i de masavaa alaadeu ne hai ai laa.
thing PREP DET time 3PL.GEN.A PFV do OBL DIST
'Then he returned and said that the youngest child was supposed to do this when the time
came.'
- (97) Ga hai gu lava de mee nei, de-naa ai d-ogu dae gi de momme
PRSP do INC finish DET thing PROX DET-MED OBL DET-1SG.GEN.O reach to DET place
naa i momme aagu e mau i de tala adu i de momme nei.
MED PREP place 1SG.GEN.A IPFV be.able PREP DET tell DIR.MED PREP DET place PROX
'This is the end, and so, I've reached the place where I am able to tell you this part of the
story.'

A.11 Taalanga o Vave (12-3) – Deiao

Speaker: Deiao

Date recorded: Spring 1966

Location: Nukuoro Atoll, Pohnpei State, Federated States of Micronesia

Recording information: Reel 12, story 3

Deiao tells the story of Vave, how he came to Nukuoro, and how he tried to find his son who had died in Tahiti. He describes how Vave sacrifices himself and becomes a whale, and how his children disobey his instructions for their return to Nukuoro.

- (1) Taalanga o Vave. A Vave se dangada Saamoa.
DET.story GEN.O Vave PN COP.SG person Samoa
 ‘The story of Vave. Vave is a Samoan person.’

- (2) Tagodo o Vave, a Vave, ia e lodo gi dahi ono henua.
DET.situation GEN.O Vave PN Vave 3SG IPFV want to one 3SG.GEN.O island
 ‘So the story of Vave, Vave wanted an island.’

- (3) Go ia donu e hodooligi ai. Abe go ia donu e huahua ai.
COP.FOC 3SG EMPH IPFV king OBL or COP.FOC 3SG EMPH IPFV control OBL
 ‘That he alone was the king of. Or that he could control.’

- (4) Tangada go Vave nei ia e dahi ono soa se gau mai
DET.person COP.FOC Vave PROX 3SG IPFV one 3SG.GEN.O friend COP.SG people DIR.PROX
 moni.
canoe
 ‘This man Vave, he had a friend from another place.’

- (5) De ingoo o d-ono soa go Gaeuli.
DET name GEN.O DET-3SG.GEN.O friend COP.FOC Gaeuli
 ‘The name of his friend was Gaeuli.’

- (6) Dahi laangi huu gai tangada go Gaeuli laa d-ono ingoo go
one day when then DET.person COP.FOC Gaeuli DIST DET-3SG.GEN.O name COP.FOC
 ssoa o Vave, gai ia gu hagadaahao i hongta tai.
DET.friend GEN.O Vave then 3SG INC play PREP top DET.sea
 ‘So one day, the man named Gaeuli, the friend of Vave, went sightseeing on the open sea.’

- (7) Gai ga han-adu gai ga hagadaahao huu a Gaeuli, gu hedaē ange ia gi
 then PRSP go-DIR.MED then PRSP play when PN Gaeuli INC meet DIR.DIST 3SG to
 de henua, d-ono ingoo go Madalama.
 DET island DET-3SG.GEN.O name COP.FOC Madalama
 ‘As Gaeuli sailed and was sightseeing, he came to an island, whose name was Madalama.’
- (8) Gai ga gidee huu e tangada nei de henua go Madalama, gai ia gu
 then PRSP see when ERG DET.person PROX DET island COP.FOC Madalama then 3SG INC
 maanadu i ono lodo bolo gu manuia loo d-ono soa go
 think PREP 3SG.GEN.O inside COMP INC lucky EMPH DET-3SG.GEN.O friend COP.FOC
 Vave gu dahi loo ono henua i d-ono lodo laa gi dahi ono
 Vave INC one EMPH 3SG.GEN.O island PREP DET-3SG.GEN.O want DIST to one 3SG.GEN.O
 henua.
 island
 ‘As that man saw the island of Madalama, he thought to himself that his friend Vave was
 so lucky that there is now an island, as he wanted to have an island for himself.’
- (9) Gai tangada go Gaeuli nei, gai ia ne han-age gi de henua nei, go
 then DET.person COP.FOC Gaeuli PROX then 3SG PFV go.SG-up to DET island PROX COP.FOC
 duaa modu oona ne baa ai.
 back islet 3SG.GEN.O PFV be.close OBL
 ‘So this person Gaeuli, he went up to this island, on the ocean-side of the islet he was
 close to.’
- (10) Gai ga baa age huu ia gi uda gai gu han-ange de libo gi
 then PRSP be.close up when 3SG to inland then INC go.SG-DIR.DIST DET jack to
 d-ono moni.
 DET-3SG.GEN.O canoe
 ‘As he came closer to the shore, the jack came toward his canoe.’
- (11) Gai ia ga hai d-ono dau gadea ga sele ai.
 then 3SG PRSP do DET-3SG.GEN.O fasten non.outrigger PRSP lasso/trap OBL
 ‘So he took his line and caught the fish with it.’

- (12) Gai ga maua huu e ia de mamu go de libo, gai ia ga han-age gi
 then PRSP be.able when IPFV 3SG DET fish COP.FOC DET jack then 3SG PRSP go.SG-up to
 dai de henua, ga daudau ai d-ono moni, i de momme e
 lagoonside DET island PRSP fasten.RED OBL DET-3SG.GEN.O canoe PREP DET place IPFV
 haga-ingoo ange laa bolo go Gubolu.
 CAUS-name DIR.DIST DIST COMP COP.FOC Gubolu
 ‘After he caught the fish, then he went up on the lagoon-side of the island, and anchored
 his canoe at the place called Gubolu.’
- (13) Gai ia ga gaav-age d-ana mamu ga han-age ga dunu.
 then 3SG PRSP bring-up DET-3SG.GEN.A fish PRSP go.SG-up PRSP cook
 ‘So he brought his fish and went up and cooked it.’
- (14) Gai e noho huu Gaeuli ma e dunu d-ana mamu, gai gu ma-dala
 then IPFV stay when Gaeuli and IPFV cook DET-3SG.GEN.A fish then INC STAT-untie
 d-ono moni.
 DET-3SG.GEN.O canoe
 ‘While Gaeuli was cooking his fish, his canoe became untied.’
- (15) Gai ia ga hano ga nnoa. Mee ne ma-dala ai laa de moni o Gaeuli,
 then 3SG PRSP go.SG PRSP tie thing PFV STAT-untie OBL DIST DET canoe GEN.O Gaeuli
 ‘So he went and tied it. The reason why Gaeuli’s canoe was untied’
- (16) gu loo-mai dengaa eidu o Sogo ma gu tala.
 INC come.PL-DIR.PROX DET.PL.SUP ghost GEN.O Sogo and INC untie
 ‘is because Sogo’s ghosts came and untied it.’
- (17) Denga eidu o Sogo ni gaibeaa.
 DET.PL ghost GEN.O Sogo COP.PL crab
 ‘The ghosts of Sogo are crabs.’
- (18) Gai ga lava ... gai ga hano huu ia ga nnoa d-ono moni gai ia
 then PRSP finish then PRSP go.SG when 3SG PRSP tie DET-3SG.GEN.O canoe then 3SG
 ga ahe age ange hogi ga dunu d-ana libo.
 PRSP return up DIR.DIST also PRSP cook DET-3SG.GEN.A jack
 ‘So after he went and tied his canoe, he returned and cooked his fish again.’

- (19) Gai tigi mmoa danuaa d-ana mamu, gai gu aahe mai hogi
 then not.yet cooked good DET-3SG.GEN.A fish then INC return.PL DIR.PROX also
 denga gaibea ga tala d-ono moni.
 DET.PL crab PRSP tell DET-3SG.GEN.O canoe
 ‘His fish was not cooked yet, and the crabs came back again and untied his canoe.’
- (20) Go eidu o Sogo.
 COP.FOC ghost GEN.O Sogo
 ‘Sogo’s ghosts.’
- (21) Dua huu de hai mee nei, gai tangada go Gaeuli nei, ga ahe gi
 back when DET do thing PROX then DET.person COP.FOC Gaeuli PROX PRSP return to
 d-ono moni, ga hano ai loo gi d-ono ... ga hano gi Saamoa.
 DET-3SG.GEN.O canoe PRSP go.SG OBL EMPH to DET-3SG.GEN.O PRSP go.SG to Samoa
 ‘After this happened, this man named Gaeuli, he returned to his (canoe) and he left to go
 back to Samoa.’
- (22) Gai ga han-adu huu ia ga dae adu gi Saamoa, gai ia ga hano
 then PRSP go.SG-DIR.MED when 3SG PRSP reach DIR.MED to Samoa then 3SG PRSP go.SG
 ga heda e ange gi d-ono soa go Vave.
 PRSP meet DIR.DIST to DET-3SG.GEN.O friend COP.FOC Vave
 ‘When he went and reached Samoa, he went and met with his friend Vave.’
- (23) Gai ia ga hai ange,
 then 3SG PRSP say DIR.DIST
 ‘And he said,’
- (24) Gu manuia loo goe e dogu soa, gu dahi loo oo henua aagu
 INC lucky EMPH 2SG VOC DET-1SG.GEN.O friend INC one EMPH 2SG.GEN.O island 1SG.GEN
 ne gide.
 PFV see
 ‘You are so lucky, my friend, you now have an island that I found.’
- (25) Gai ga lango-na huu e Vave muna a d-ono soa go Gaeuli,
 then PRSP hear-CIA when ERG Vave word GEN.A DET-3SG.GEN.O friend COP.FOC Gaeuli
 gai ia gu kona mmao de malangilangi.
 then 3SG INC very vast DET happy
 ‘And when Vave heard what his friend Gaeuli said, he became so happy.’

- (26) Gai tigi hu-mai ai loo a Vave gi de henua go Madalama, gai
 then not.yet come.SG-DIR.PROX OBL EMPH PN Vave to DET island COP.FOC Madalama then
 ia gu hagadabena ono mee, gilaadeu ma d-ono huaa bodu.
 3SG INC prepare 3SG.GEN.O thing 3PL and DET-3SG.GEN.O family
 ‘Vave had not yet come to Nukuoro, but he had already prepared his things, him and his
 family.’
- (27) Gai a Vave ga hai de moni e haga-ingoo ange laa bolo go de
 then PN Vave PRSP do DET canoe IPFV CAUS-name DIR.DIST DIST COMP COP.FOC DET
 Hao-lua, gu lava, gai gilaadeu ma d-ono huaabodu ga malanga ga
 tie-two INC finish then 3PL and DET-3SG.GEN.O family PRSP depart PRSP
 loo-mai gi de henua go Madalama.
 come.PL-DIR.PROX to DET island COP.FOC Madalama
 ‘So Vave made the canoe which was called the haolua, and then he and his family set sail
 and left for the island of Madalama (Nukuoro).’
- (28) Gai ga dae mai huu a Vave gi de henua go Madalama ga noho ai,
 then PRSP reach DIR.PROX when PN Vave to DET island COP.FOC Madalama PRSP live OBL
 gai a Sogo gu hagadau mee ange gi a Vave.
 then PN Sogo INC argue DIR.DIST to PN Vave
 ‘When Vave reached the island of Madalama and stayed there, Sogo argued with Vave.’
- (29) Gai ga hagadau mee huu gilaau ma Sogo, gai gilaau ga hai de-laau
 then PRSP argue when 3DU and Sogo then 3DU PRSP make DET-3DU.GEN
 hagatoo donu
 promise
 ‘And when he and Sogo argued, they made an agreement’
- (30) bolo de-nei de hai e hai ai. Gilaau e daudau.
 COMP DET-PROX DET way IPFV do/make OBL 3DU IPFV wrestle
 ‘that this is what would happen. They would wrestle.’
- (31) Ga kii naa huu a Vave, ni-oona ai loo de henua, gai ga kii
 PRSP win IRR when PN Vave INDEF.PL-3SG.GEN.O OBL EMPH DET island then PRSP win
 naa huu a Sogo, ni o Sogo ai loo de henua.
 IRR when PN Sogo COP.PL GEN.O Sogo OBL EMPH DET island
 ‘If Vave won, the island would be his, and if Sogo won, the island would belong to Sogo.’

- (32) Gai ga daudau huu a Sogo ma denga daane i de moni o Vave, gilaadeu
 then PRSP wrestle when PN Sogo with DET.PL man PREP DET canoe GEN.O Vave 3PL
 ne daudau i mua e kii ai a Sogo.
 PFV wrestle PREP front IPFV IPFV OBL PN Sogo
 ‘So when Sogo wrestled with the men on Vave’s canoe, they wrestled first and defeated Sogo.’
- (33) Gai e dahi dangada de moni o Vave e haga-ingoo ange laa bolo
 then IPFV one person DET canoe GEN.O Vave IPFV CAUS-name DIR.DIST DIST COMP
 go laebiholua.
 COP.FOC laebiholua
 ‘And there was a man on Vave’s canoe who was called laebiholua (lit. ‘he has two heads’).’
- (34) De-nei tangada ne kii laa i taudau, ne kii laa i a Sogo i
 DET-PROX DET.person PFV win DIST PREP DET.wrestle PFV win DIST PREP PN Sogo PREP
 taudau.
 DET.wrestle
 ‘This is the man who won at wrestling, who won against Sogo at wrestling.’
- (35) Gai ga kii huu de gau de moni o Vave i taudau i a Sogo,
 then PRSP win when DET people DET canoe GEN.O Vave PREP DET.wrestle PREP PN Sogo
 gai a Sogo gu hano gee ai loo i de henua go Madalama.
 then PN Sogo INC go.SG away OBL EMPH PREP DET island COP.FOC Madalama
 ‘So when the people on Vave’s canoe won at wrestling against Sogo, Sogo left the island of Madalama.’
- (36) Gai ia ga taa d-ana laulau gelegele, kave ga hano ai.
 then 3SG PRSP fill DET-3SG.GEN.A basket sand take PRSP go.SG OBL
 ‘So he filled up his basket of sand, took it and left.’
- (37) Gai d-ono masavaa ne hano ai, gai denga gelegele i
 then DET-3SG.GEN.O time PFV go.SG OBL then DET.PL sand PREP
 t-ana laulau ga malili.
 inside.DET-3SG.GEN.A basket PRSP fell.out
 ‘And when he went, the sand inside his basket fell out little by little.’
- (38) Go ia ne ssomo age ai laa denga henua, o Moodolago.
 COP.FOC 3SG PFV grow.PL up OBL DIST DET.PL island GEN.O Mortlocks
 ‘That is how the Mortlock islands were formed.’

- (39) Ne kii laa i a Sogo i taudau.
 PFV win DIST PREP PN Sogo PREP DET.wrestle
 ‘They won over Sogo at wrestling.’
- (40) Gai ga lava huu i de kii o taane nei i a Sogo, gai gu sula
 then PRSP finish when PREP DET win GEN.O DET.man PROX PREP PN Sogo then INC succeed
 ai loo ma gu ... ni-oo Vave de henua go Madalama.
 OBL EMPH and INC INDEF.PL-GEN.O Vave DET island COP.FOC Madalama
 ‘So after this man won over Sogo, the agreement was carried out, and the island of
 Madalama belonged to Vave.’
- (41) Gai ga sula huu go Vave e henua i de henua go Madalama
 then PRSP succeed when COP.FOC Vave IPFV island PREP DET island COP.FOC Madalama
 gai a Sogo gu hano gee ai loo i de henua go Madalama.
 then PN Sogo INC go.SG away OBL EMPH PREP DET island COP.FOC Madalama
 ‘So according to the agreement, Vave became the leader of the island of Madalama, and
 Sogo went away from the island of Madalama.’
- (42) Gai ia ga taa ana gelegele, i lot-ana laulau ga hano ai.
 then 3SG PRSP fill 3SG.GEN.A sand PREP inside.DET-3SG.GEN.A basket PRSP go.SG OBL
 ‘And he filled sand into his basket and left.’
- (43) E malili denga gelegele i lote laulau a Sogo i d-ono masavaa
 IPFV fall.out DET.PL sand PREP inside.DET basket PN Sogo PREP DET-3SG.GEN.O time
 ne hano ai.
 PFV go.SG OBL
 ‘The sand inside Sogo’s basket fell out little by little when he left.’
- (44) Go ia ai ne ssomo age ai laa denga henua, o Moodolago.
 COP.FOC 3SG OBL PFV grow.PL up OBL DIST DET.PL island GEN.O Mortlocks
 ‘That’s what created the Mortlock islands.’
- (45) De-nei ai de ngado o Sogo.
 DET-PROX OBL DET end GEN.O Sogo
 ‘This is the end of Sogo.’

- (46) Gai dua mee nei gai go Vave ai loo gu henua i de henua go
 then back thing PROX then COP.FOC Vave OBL EMPH INC island PREP DET island COP.FOC
 Nuguolo.
 Nukuoro
 ‘From then on, it was Vave who was the leader of Nukuoro.’
- (47) Gai tagodo o Vave i d-ono noho i Nuguolo, hanu masavaa
 then DET.situation GEN.O Vave PREP DET-3SG.GEN.O live PREP Nukuoro some time
 huu gai ia gu hano saele.
 when then 3SG INC go.SG around
 ‘And while Vave lived on Nukuoro, occasionally he traveled around.’
- (48) Gu hano ange gi hanu henua.
 INC go.SG DIR.DIST to some island
 ‘He went around to some islands.’
- (49) E lagolago henua o Vave ne hano gi agina, i d-ono masavaa nogo
 IPFV many island GEN.O Vave PFV go.SG to OBL PREP DET-3SG.GEN.O time PST.IPFV
 noho ai i de henua go Madalama.
 live OBL PREP DET island COP.FOC Madalama
 ‘There were many islands that Vave went to, while he was living on Madalama.’
- (50) A Vave e dogo-lua ana dama daane, e dogo-lua ana damaa
 PN Vave IPFV CL.HUM-two 3SG.GEN.A child man IPFV CL.HUM-two 3SG.GEN.A child
 hine.
 woman
 ‘Vave had two sons and two daughters.’
- (51) De ingoo tama madua a Vave, go Iaidemalo.
 DET name DET.child old PN Vave COP.FOC Iaidemalo
 ‘The name of Vave’s oldest child was Iaidemalo.’
- (52) Tama daane. Gai togo-lua dama, go Deagu.
 DET.child man so DET.CL-HUM-two child COP.FOC Deagu
 ‘The son. And the second child was Deagu.’

- (53) Gai lu-aana damaa hine, e dahi go Gauna, gai e dahi go
 then DET.DU-3SG.GEN.A child woman IPFV one COP.FOC Gauna then IPFV one COP.FOC
 Hagalolo.
 Hagalolo
 ‘And his two daughters, there was one named Gauna and another named Hagalolo.’
- (54) Tama a Vave d-ono ingoo laa go Iaidemalo ia e hai bodu
 DET.child PN Vave DET-3SG.GEN.O name DIST COP.FOC Iaidemalo 3SG IPFV make spouse
 i dahi hahine Moodolago ...
 PREP one woman Mortlock
 ‘Vave’s son whose name was Iaidemalo, he was married to a Mortlockese woman.’
- (55) Dee iloo danuaa loo de ingoo de bodu o Iaidemalo.
 NEG know good EMPH DET name DET spouse GEN.O Iaidemalo
 ‘I don’t know the name of Iaidemalo’s wife.’
- (56) Gai tamana o de bodu o Iaidemalo, go Logo.
 then DET.father GEN.O DET spouse GEN.O Iaidemalo COP.FOC Logo
 ‘But the father of his... Iaidemalo’s wife was Logo.’
- (57) De-nei tangada a Vave ne haga-ago laa luono dangada hai
 DET-PROX DET.person PN Vave PFV CAUS-teach/learn DIST DET.DU-3SG.GEN.O person do
 hegau gi hulo gi da-ia.
 work SBJV go.PL SBJV kill-CIA
 ‘That was the person who Vave ordered two of his servants to go and kill.’
- (58) Gai Iaidemalo ga hano gee ai laa i daho Vave.
 then Iaidemalo PRSP go.SG away OBL DIST PREP place.GEN Vave
 ‘And Iaidemalo left Vave because of this.’
- (59) Gai ga loo-adu huu luu dangada nei e daa tamana de bodu
 then PRSP go.PL-DIR.MED when DET.DU person PROX IPFV kill DET.father DET spouse
 o Iaidemalo, gai a Iaidemalo, gu gidee ia.
 GEN.O Iaidemalo then PN Iaidemalo INC see 3SG
 ‘So when these two people came to kill the father of Iaidemalo’s wife, Iaidemalo saw
 (them).’

- (60) Gai ia ga hai ange gi luu dangada nei, luu dangada hai hegau o
 then 3SG PRSP say DIR.DIST to DET.DU person PROX DET.DU person do work GEN.O
 Vave, Gilaau gi dee hulo gi da-ia ina a Logo.
 Vave 3DU SBJV NEG go.PL SBJV kill-CIA INA PN Logo
 ‘And he said to these two men, Vave’s two servants, You should not go to kill Logo.’
- (61) Gai gilaau gi loo-ange gi da-ia ia.
 then 3DU SBJV come.PL-DIR.DIST SBJV kill-CIA 3SG
 ‘Come and kill me.’
- (62) Agai luu dangada hai hegau o Vave, ga aahe mai ga hai ange
 then DET.DU person do work GEN.O Vave PRSP return.PL DIR.PROX PRSP say DIR.DIST
 gi a Vave bolo e dee iloo e gilaau de hulo e daa... Iaidemalo e hai
 to PN Vave COMP IPFV NEG know ERG 3DU DET go.PL IPFV kill Iaidemalo IPFV say
 ange bolo ga hulo huu gilaau e daa a Logo, ma gi loo-ange gi
 DIR.DIST COMP PRSP go.PL when 3DU IPFV kill PN Logo and SBJV come.PL-DIR.DIST SBJV
 da-ia ia i mua.
 kill-CIA 3SG PREP front
 ‘So the two servants of Vave returned and told Vave that they couldn’t go and kill him...
 Iaidemalo said that if they wanted to kill Logo, they’d have to kill him first.’
- (63) Luu dangada hai hegau o Vave nei, aa-nei luu dangada e haga-ingoo
 DET.DU person do work GEN.O Vave PROX PL-PROX DET.DU person IPFV CAUS-name
 laa bolo go luu daagami.
 DIST COMP COP.FOC DET.DU soldier
 ‘These two servants of Vave, these people were called *daagami* (guards).’

- (64) Gai ga aahe mai huu luu dangada hai hegau o Vave, i de
 then PRSP return.PL DIR.PROX when DET.DU person do work GEN.O Vave PREP DET
 hai ange laa a Iaidemalo bolo gi gilaau gi dee da-ia a Logo, gi
 say DIR.DIST DIST GEN.A Iaidemalo COMP to 3DU SBJV NEG kill-CIA PN Logo SBJV
 loo-ange gi da-ia ia, gai Iaidemalo ga hu-mai gi
 come.PL-DIR.DIST SBJV kill-CIA 3SG then Iaidemalo PRSP come.SG-DIR.PROX to
 d-ono hale, gai ia ga hagahi d-ono bodu gu hano gi de
 DET-3SG.GEN.O house then 3SG PRSP call DET-3SG.GEN.O spouse INC go.SG to DET
 husi.
 taro.patch
 ‘So when Vave’s two guards returned, after Iaidemalo told them that they should not kill
 Logo, but kill him instead, Iaidemalo came to his house and he called his wife who had
 gone to the taro patch.’
- (65) Gi daa-ngia de oo e hulo ai gilaadeu, gi lalo de langi.
 SBJV pull-CIA DET cut.taro IPFV go.PL OBL 3PL to below DET sky
 ‘To pick taro so that they could leave and go off to the horizon.’
- (66) Gai ga lango-na huu e de bodu o Iaidemalo de muna nei bolo gilaadeu
 then PRSP hear-CIA when ERG DET spouse GEN.O Iaidemalo DET word PROX COMP 3PL
 ga hulo gi lalo de langi, gai ia gu kona de lele ono mouli.
 PRSP go.PL to below DET sky then 3SG INC very DET jump 3SG.GEN.O life
 ‘And when Iaidemalo’s wife heard these words, that they would go off to the horizon, she
 was so shocked.’
- (67) E hagadaba age de hine nei,
 IPFV say up DET woman PROX
 ‘And she said to herself’
- (68) Bolo henua o dangada, goe Leibua.
 COMP island GEN.O person 2SG Leibua
 ‘Woe is Leibua, I am all alone here.’
- (69) De-laa ai, gai a Iaidemalo, ma d-ono bodu, ma tamana o
 DET-DIST OBL then PN Iaidemalo and DET-3SG.GEN.O spouse and DET.father GEN.O
 d-ono bodu, gilaadeu ga aahe ai loo.
 DET-3SG.GEN.O spouse 3PL PRSP return.PL OBL EMPH
 ‘And so, Iaidemalo, his wife, and his wife’s father, they all left.’

- (70) Gu doo-ange olaadeu mee e aahe e hulo gi lalo de langi.
 INC drop-DIR.DIST 3PL.GEN.O thing IPFV return.PL IPFV go.PL to below DET sky
 ‘They packed their things to leave and go off to the horizon.’
- (71) Gai de masavaa huu Iaidemalo ne malanga ai ga hano iho gi ngaadai
 then DET time when Iaidemalo PFV depart OBL PRSP go.SG down to lagoon.side
 Saavae, gai d-ono damana go Vave ga basa iho ga hai ange.
 Saavae then DET-3SG.GEN.O father COP.FOC Vave PRSP talk down PRSP say DIR.DIST
 ‘So when Iaidemalo left and went down to the lagoon-side of Saavae, his father Vave called
 down to him and said,’
- (72) Manadua mai, duaa goe d-oo henua.
 remember DIR.PROX back 2SG DET-2SG.GEN.O island
 ‘Remember, your island is behind you.’
- (73) Gai Iaidemalo ga basa ange ga hai ange gi a Vave,
 then Iaidemalo PRSP talk DIR.DIST PRSP say DIR.DIST to PN Vave
 ‘And Iaidemalo spoke and said to Vave,’
- (74) Olomanga e hai ai dago o dengaa aligi, gai denga ahubaua e gai mee
 Olomanga IPFV do OBL rituals GEN.O DET.PL.SUP chief so DET.PL ?? IPFV eat thing
 ai a Delulu, e tilo ange ai de henua.
 OBL PN Delulu IPFV look DIR.DIST OBL DET island
 ‘Olomanga is where the chiefs do their rituals, and the ahubaua are eaten by Delulu, who
 takes care of the island.’
- (75) De-nei de hai ai de ... Iaidemalo ne bolo ai, d-ono henua.
 DET-PROX DET way OBL DET Iaidemalo PFV make.will OBL DET-3SG.GEN.O island
 ‘This is the will that Iaidemalo made, for his island.’
- (76) De muna a Vave ne hai ange laa gi d-ana dama go Iaidemalo,
 DET word GEN.A Vave PFV say DIR.DIST DIST to DET-3SG.GEN.A child COP.FOC Iaidemalo
 manadua mai duaa goe doo henua, e bei, ia gi bolo-a ina, ono
 remember DIR.PROX behind 2SG drop island IPFV like 3SG to make.will-CIA INA 3SG.GEN.O
 mee.
 thing
 ‘The words that Vave said to his son Iaidemalo, *Manadua mai duaa goe doo henua*, is like,
 he should make a will for his possessions.’

- (77) De-laa ai gai Iaidemalo gu hano gee ai loo, mai i de henua go
 DET-DIST OBL then Iaidemalo INC go.SG away OBL EMPH DIR.PROX PREP DET island COP.FOC
 Madalama, gu hano.
 Madalama INC go.SG
 ‘And so, Iaidemalo went away from the island of Madalama (Nukuoro), and left.’
- (78) Tee iloo danuaa be go hee oona ne hano gi agina.
 PFV.NEG know good COMP.INT COP.FOC where 3SG.GEN.A PFV go.SG to OBL
 ‘I’m not sure where he went to.’
- (79) Gai dahi laangi huu, gai ssoa o Vave, d-ono ingoo laa go
 then one day when then DET.friend GEN.O Vave DET-3SG.GEN.O name DIST COP.FOC
 Gaeuli,
 Gaeuli
 ‘Then one day, Vave’s friend, by the name of Gaeuli,’
- (80) gu ahe mai hogi ga hu-mai gi de henua go Madalama, gi
 INC return DIR.PROX also PRSP come.SG-DIR.PROX to DET island COP.FOC Madalama to
 daho Vave.
 place.GEN Vave
 ‘returned again and came to the island of Madalama, to Vave.’
- (81) Gai ga madaa-ngudu huu gilaau ma Vave, gai a Vave ga ssili ange,
 then PRSP front-mouth when 3DU with Vave then PN Vave PRSP ask DIR.DIST
 ‘And when he and Vave talked, Vave asked him,’
- (82) E dee gidee naa loo goe taau dama?
 IPFV NEG see IRR EMPH 2SG DET.1DU.INCL child
 ‘Didn’t you see our son?’
- (83) Gai ga ssili ange huu a Vave gi Gaeuli, be dee gidee laa loo e ia
 then PRSP asked DIR.DIST when PN Vave to Gaeuli if NEG see DIST EMPH ERG 3SG
 de-laau dama, gai a Gaeuli ga hai ange gi de ia,
 DET-3DU.GEN child then PN Gaeuli PRSP say DIR.DIST to DET 3SG
 ‘And when Vave asked Gaeuli, if he hadn’t seen their son, Gaeuli said to him,’

- (84) D-ogu hu-mai nei, gai e dahi daane e huna i de
 DET-1SG.GEN.O come.SG-DIR.PROX PROX then IPFV one man IPFV loincloth PREP DET
 malo, gai e gili tea, e daa hagasaalei, e laalaa-ngia i de gula
 clothes then IPFV skin white IPFV tattoo striped IPFV roast.RED-CIA PREP DET pyre
 i Hidi.
 PREP Tahiti
 ‘When I came, there was a man wearing a loincloth, with white skin, who had chiefly
 tattoos, who was roasted on the pyre in Tahiti.’
- (85) Dahi dagodo, abe tagodo, de-nei go kilaa o tama a Vave
 one situation or DET.situation DET-PROX COP.FOC there GEN.O DET.child PN Iaidemalo
 go Iaidemalo, ne maaleele ai go de gula i Hidi.
 COP.FOC Iaidemalo PFV die OBL COP.FOC DET pyre PREP Tahiti
 ‘Somehow, one way or another, this is how Vave’s son Iaidemalo was killed, on the pyre
 in Tahiti.’
- (86) Gai dua huu mee nei, gai a Vave gu maanadu age bolo ia ga hano hogi
 then back when thing PROX then PN Vave INC think up COMP 3SG PRSP go.SG also
 e hagadaahao,
 IPFV play
 ‘After this, Vave decided he would also go travel around.’
- (87) gilaadeu ma d-ono huua bodu.
 3PL and DET-3SG.GEN.O family
 ‘he and his family.’
- (88) Gai ga malanga huu a Vave, mai de henua go Madalama, ga hano,
 then PRSP depart when PN Vave DIR.PROX DET island COP.FOC Madalama PRSP go.SG
 gilaadeu ga hulo ga tau i de henua go Oneabu.
 3PL PRSP go.PL PRSP arrive.PL PREP DET island COP.FOC Oneop
 ‘When Vave set sail from Madalama and left, they went and arrived the island of Oneop.’
- (89) Gai ga tau age huu gilaadeu i de henua go Oneabu, gai denga
 then PRSP arrive.PL up when 3PL PREP DET island COP.FOC Oneop then DET.PL
 daane, i de henua laa ga loo-iho e he-bagi ange gi gilaadeu.
 man PREP DET island DIST PRSP come.PL-down IPFV RCPR-fight DIR.DIST to 3PL
 ‘When they arrived at the island of Oneop, the men of the island came to attack them.’

- (90) Gai gilaadeu gu gage de hada, i hongade moni.
 then 3PL INC climb DET platform PREP top DET canoe
 'And they climbed onto the platform, on top of the canoe.'
- (91) De-nei de momme o Vave ne lodo baubau ai laa, gai ia ga vaivai basa
 DET-PROX DET place GEN.O Vave PFV upset OBL DIST then 3SG PRSP bad talk
 ange gi d-ana dama, d-ono ingoo laa go Deagu.
 DIR.DIST to DET-3SG.GEN.A child DET-3SG.GEN.O name DIST COP.FOC Deagu
 'This is the place where Vave got angry, and talked badly to his son, whose name is Deagu.'
- (92) Hidinga mai i madagidagi loo i de hulo saele o Vave ma
 because DIR.PROX PREP old.RED EMPH PREP DET go.PL around GEN.O Vave and
 d-ana dama go laidemalo, gai e deai donu dangada e maua i
 DET-3SG.GEN.A child COP.FOC laidemalo then IPFV no EMPH person IPFV be.able PREP
 de gage mai, hongade hada o de-laadeu moni.
 DET climb DIR.PROX top DET platform GEN.O DET-3PL.GEN canoe
 'Because all the times that Vave traveled around with his son laidemalo, nobody was ever
 able to climb onto the platform of their canoe.'
- (93) Hidinga taane go laidemalo laa, e kona de lo taane.
 because DET.man COP.FOC laidemalo DIST IPFV very DET brave
 'Because that man laidemalo, he was a very brave man.'
- (94) Gai de laangi nei ga tau huu gilaadeu i de henua go Oneabu ga
 then DET day PROX PRSP arrive.PL when 3PL PREP DET island COP.FOC Oneop PRSP
 loo-iho denga daane, e he-bagi ange gi gilaadeu, gai denga daane ga
 come.PL-down DET.PL man IPFV RCPR-fight DIR.DIST to 3PL so DET.PL man PRSP
 gage mai hongade hada delaadeu moni.
 climb DIR.PROX top DET platform DET-3PL.GEN canoe
 'So when they arrived at the island of Oneop, and the men came down to fight them, the
 men climbed on top of the platform of their canoe.'
- (95) Gai ga gaagea huu d-ono hada, gai ia gu lodo baubau, gai ia ga
 then PRSP climb.CIA when DET-3SG.GEN.O platform so 3SG INC upset so 3SG PRSP
 vaivai basa ange gi d-ana dama,
 badly talk DIR.DIST to DET-3SG.GEN.A child
 'So when they climbed on his platform, he became angry, and he insulted his son.'

- (96) d-ono ingoo laa go Deagu.
 DET-3SG.GEN.O name DIST COP.FOC Deagu
 ‘whose name was Deagu.’
- (97) De-laa ai gai de gau de henua laa ga gaav-age a Vave, ma de gau
 DET-DIST OBL then DET people DET island DIST PRSP bring-up PN Vave and DET people
 d-ono moni gi delaadeu henua ga dugu ai.
 DET-3SG.GEN.O canoe to DET-3PL.GEN island PRSP keep OBL
 ‘So the people of that island brought Vave and the people on his canoe to their island and kept them there.’
- (98) Gai ga nnoho nnoho nnoho ai huu gilaadeu i de henua go Oneabu laa,
 then PRSP live.PL live.PL live.PL OBL when 3PL PREP DET island COP.FOC Oneabu DIST
 gai de gau laa gu dugu hogi gilaadeu gi hulo.
 then DET people DIST INC allow also 3PL SBJV go.PL
 ‘So they stayed and stayed on the island of Oneabu, and the people there let them go.’
- (99) Gai de masavaa huu o Vave ma de gau d-ono moni ne maalanga
 then DET time when GEN.O Vave and DET people DET-3SG.GEN.O canoe PFV depart.PL
 ai ga hulo, e aahe mai gi de henua go Madalama, gai de
 OBL PRSP go.PL IPFV return.PL DIR.PROX to DET island COP.FOC Madalama then DET
 gau de henua laa ga gaa-mai de gau madumaadua gi helau-a dengaa
 people DET island DIST PRSP bring DET people old.PL.RED to do.magic-CIA DET.PL.SUP
 lango nogo lango ai laa de moni o Vave.
 canoe.log PST.IPFV canoe.log OBL DIST DET canoe GEN.O Vave
 ‘When Vave and the people on his canoe set sail to return to the island of Madalama, the people of the island brought the older people to bewitch the canoe logs that had protected Vave’s canoe.’
- (100) Gai de gau laa ga helau dengaa lango, gai de labodo ga
 then DET people DIST PRSP do.magic DET.PL.SUP canoe.log then DET eel PRSP
 hu-mai ga ulu ange gi lote ama de moni o Vave.
 come.SG-DIR.PROX PRSP enter DIR.DIST to inside.DET outrigger.float DET canoe GEN.O Vave
 ‘When the people bewitched the canoe logs, then the eel went inside the outrigger float of Vave’s canoe.’

- (101) Gai ga loo-mai huu gilaadeu ga paa mai gi de henua
 then PRSP come.PL-DIR.PROX when 3PL PRSP be.close.PL DIR.PROX to DET island
 go Madalama, gu dai sula de henua, gai de labodo ga bae gee
 COP.FOC Madalama INC almost appear DET island then DET eel PRSP push away
 de-laadeu moni i de henua.
 DET-3PL.GEN canoe PREP DET island
 ‘When they came near to the island of Madalama, and the island had almost appeared, the
 eel pushed their canoe away from the island.’
- (102) Gai gilaadeu ga sege laa dahi luu baasi de henua ga hulo ai.
 then 3PL PRSP slip DIST one DET.DU side DET island PRSP go.PL OBL
 ‘And they slipped past one side of the island and went away.’
- (103) Dee maua gi dau henua. De-laa ai tagodo o Vave ma ana dama.
 NEG be.able to arrive island DET-DIST OBL DET.situation GEN.O Vave and 3SG.GEN.A child
 ‘They couldn’t reach the island. So that’s what happened to Vave and his children.’
- (104) Gilaadeu gu baa ange gi de maakau, dai gu deai alaadeu gai, dai
 3PL INC be.close DIR.DIST to DET die.PL, almost INC no 3PL.GEN.A food almost
 deai alaadeu me e unu ai.
 no 3PL.GEN.A thing IPFV drink OBL
 ‘They came close to dying, they almost didn’t have any food, and they almost had nothing
 to drink.’
- (105) Gai ga dagodo huu gilaadeu be nei, gai a Vave ga hai ange gi
 then PRSP lay when 3PL like PROX then PN Vave PRSP say DIR.DIST to
 lu-aana damaa hine,
 DET.DU-3SG.GEN.A child woman
 ‘So when this happened to them, Vave said to his two daughters,’
- (106) Hai ange muhuu gi d-ooluu bodu, gi buubuu ange muhuu gi diiloo
 say DIR.DIST please to DET-2DU.GEN spouse SBJV foretell DIR.DIST please to look.CIA
 be dehee taadeu dagodo.
 COMP.INT which DET.1PL.INCL situation
 ‘Please ask your husband to do a divination to see what our situation is.’

- (107) Gai ga hai ange huu luu damaa hine a Vave gi de-laau bodu
 then PRSP say DIR.DIST when DET.DU child woman GEN.A Vave to DET-3DU.GEN spouse
 gi buubuu ange, gai taane laa ga buubuu.
 SBJV foretell DIR.DIST so DET.man DIST PRSP foretell
 ‘So when Vave’s two daughters told their husband to do the oracle, that man did his divination.’
- (108) Ga buubuu adu huu, de mee a de buubuu ne gide, ga magau naa
 PRSP foretell DIR.MED when DET thing GEN.A DET divination PFV see PRSP die IRR
 a Vave, gai gilaadeu denga dama, ga tau i de henua.
 PN Vave then 3PL DET.PL child PRSP arrive.PL PREP DET island
 ‘When he did the oracle, the divination foretold that if Vave died, then they, the children, would make landfall.’
- (109) Agai dee go Vave naa huu e magau, agai e odi naa gilaadeu i de
 then NEG COP.FOC Vave IRR when IPFV die then IPFV empty IRR 3PL PREP DET
 maakau, gai a Vave sogosogo ga dau i de henua.
 die.PL then PN Vave alone PRSP arrive PREP DET island
 ‘But if it wasn’t Vave who died, and if they all died instead, Vave alone would reach the island.’
- (110) Gai ga lava huu i de tala ange a de bodu o luu damaa
 then PRSP finish when PREP DET tell DIR.DIST GEN.A DET spouse GEN.O DET.DU child
 hine a Vave muna nei gi luu damaa hine laa, gai gilaadeu gu dee
 woman GEN.A Vave word PROX to DET.DU child woman DIST then 3PL INC NEG
 llodo e tala ange gi de-laadeu damana go Vave.
 want.PL IPFV tell DIR.DIST to DET-3PL.GEN father COP.FOC Vave
 ‘So after the husband of Vave’s two daughters told this to the two daughters, they didn’t want to tell their father Vave.’
- (111) Gai gilaadeu ga daahea saele ai donu huu be laa laa de moana, dee maua
 then 3PL PRSP drift.PL around OBL only like DIST DIST DET open.sea NEG be.able
 gi dau henua.
 SBJV arrive island
 ‘So as they drifted around like that on the open sea, they were unable to reach land.’

- (112) Gai gu dolu huu laangi ne ssili, gai a Vave ga haga-ahe ange hogi
 then INC three when day PFV pass.PL then PN Vave PRSP CAUS-return DIR.DIST also
 d-ana muna mau ga hai ange,
 DET-3SG.GEN.A word usual PRSP say DIR.DIST
 ‘After three days had gone by, Vave returned to his same question and said.’
- (113) Gooluu hai ange muhoo gi d-ooluu bodu, haga-laango-na muhoo de lau
 2DU say DIR.DIST please to DET-2DU.GEN spouse CAUS-listen-CIA please DET leaf
 nui, be dehee tagodo odaadeu gu dee dau henua ai nei.
 coconut.palm COMP.INT which DET.situation 1PL.INCL.O INC NEG arrive island OBL PROX
 ‘You two, please ask your husband to listen to the coconut leaf to find out why we cannot
 make landfall.’
- (114) Gai de hanonga nei huu, gai luu damaa hine a Vave, ga tala ange
 then DET iteration PROX when then DET.DU child woman GEN.A Vave PRSP tell DIR.DIST
 me abo donu gi delaau damana.
 thing true EMPH to DET-3DU.GEN father
 ‘And this time, Vave’s two daughters told the truth to their father.’
- (115) Gai ga daalaa ange huu gilaau, gai gilaau ga hai ange,
 then PRSP tell.CIA DIR.DIST when 3DU then 3DU PRSP say DIR.DIST
 ‘And when they told him, they said.’
- (116) De-nei de me a de buubuu ne haga-ago mai, bolo i
 DET-PROX DET thing GEN.A DET divination PFV CAUS-learn DIR.PROX COMP PREP
 de-maau bodu.
 DET-1DU.EXCL.GEN spouse
 ‘This is what the divination showed us, according to our husband.’
- (117) Ga magau naa goe, gai gimaadeu ga dau henua.
 PRSP die IRR 2SG then 1PL.EXCL PRSP arrive island
 ‘If you die, we will make landfall.’
- (118) Aabe odi naa gimaadeu de maakau, gai koe sogosogo donu huu ga dau
 or empty IRR 1PL.EXCL DET die.PL then 2SG alone EMPH when PRSP arrive
 henua.
 island
 ‘Or if we all die, then only you will reach land.’

- (119) Gai ga tala ange huu, be nei luu damaa hine a Vave, gi a Vave,
 then PRSP tell DIR.DIST when like PROX DET.DU child woman GEN.A Vave to PN Vave
 gai a Vave ga hai ange,
 so PN Vave PRSP say DIR.DIST
 ‘So when Vave’s two daughters told this to Vave, then Vave said.’
- (120) D-ooluu ssenga. Ga hai gu iloo gooluu tagodo naa, gai gooluu e
 DET-2DU.GEN stupid PRSP make INC know 2DU DET.situation MED then 2DU IPFV
 dee tala mai.
 NEG tell DIR.PROX
 ‘You fools! You knew this, and you didn’t tell me.’
- (121) Gooluu e tali de aha? De magau o d-ooluu dama.
 2DU IPFV wait DET what DET die GEN.O DET-2DU.GEN child
 ‘What were you waiting for? For your child to die?’
- (122) Tamaa gauligi nei, go tama a Iaidemalo.
 DET.child young PROX **foC** DET.child GEN.A Iaidemalo
 ‘This child was the child of Iaidemalo.’
- (123) D-ono ingoo laa go Dehegevaealigi.
 DET-3SG.GEN.O name DIST COP.FOC Dehegevaealigi
 ‘His name was Dehegevaealigi.’
- (124) Gai ga lava huu muna nei de tala ange a luu damaa hine a
 then PRSP finish when word PROX DET tell DIR.DIST GEN.A DET.DU child woman GEN.A
 Vave gi a Vave, gai a Vave ga iho gi lalo, magavaa luu giado
 Vave to PN Vave then PN Vave PRSP down to below between DET.DU outrigger.boom
 de-laadeu moni
 DET-3PL.GEN canoe
 ‘So after Vave’s daughters told Vave about this, then Vave went down between the two
 outrigger booms of their canoe.’
- (125) ga dagodo ai i lausedi.
 PRSP lay OBL PREP salt.water
 ‘and laid in the water.’

- (126) E dolu boo o Vave ne dagodo ai i lalo tai magavaa luu
 IPFV three night GEN.O Vave PFV lay OBL PREP below DET.sea between DET.DU
 giado de-laadeu moni.
 outrigger.boom DET-3PL.GEN canoe
 ‘For three nights Vave laid in the water in between the two outrigger booms of their canoe.’
- (127) Gai dengaa mamu ga loo-mai ga dongidongi denga huga o
 then DET.PL.SUP fish PRSP come.PL-DIR.PROX PRSP peck.RED DET.PL threads GEN.O
 d-ono malo.
 DET-3SG.GEN.O clothes
 ‘And the fish came and nibbled the threads of his clothes.’
- (128) Gai ana dama ga booboo ga gai mee ai gilaadeu.
 then 3SG.GEN.A child PRSP grab.RED PRSP then thing OBL 3PL
 ‘And his children grabbed them and ate them.’
- (129) Gai tolu boo huu, gai taholaa ga hu-mai ga holo a Vave.
 then DET.three night when then DET.whale PRSP come.SG-DIR.PROX PRSP swallow PN Vave
 ‘On the third night, the whale came and swallowed Vave.’
- (130) Gai muna hagaodi, go muna a Vave, go muna, magavaa niho o
 then word CAUS-empty COP.FOC word PN Vave COP.FOC word between teeth GEN.O
 taholaa.
 DET.whale
 ‘And Vave’s last words were spoken between the teeth of the whale.’
- (131) Go tagodo o de doo de maduu aama de dau o
 COP.FOC DET.situation GEN.O DET drop DET mature.coconut and DET arrive GEN.O
 taholaa aama tangada e gava ina taholaa.
 DET.whale and DET.person IPFV cut.open INA DET.whale
 ‘It was about the planting of the mature coconut and the arrival of the whale and the person who would cut open the whale.’
- (132) E hai ange a Vave gi ana dama,
 IPFV say DIR.DIST PN Vave to 3SG.GEN.A child
 ‘Vave told his children,’
- (133) Ga tau naa huu goodou, gai goodou doo-a ina de maduu.
 PRSP arrive.PL IRR when 2PL then 2PL plant-CIA INA DET mature.coconut
 ‘When you arrive, plant the mature coconut.’

- (134) Gai ga lau valu naa huu de maduu, gai gu dau taholaa.
 then PRSP leaf eight IRR when DET mature.coconut then INC arrive DET.whale
 ‘And when the coconut has eight leaves, the whale will arrive.’
- (135) Gai ga dau naa huu taholaa, gai go Dehegevaealigi ni-aana de
 then PRSP arrive IRR when DET.whale then COP.FOC Dehegevaealigi COP.PL-3SG.GEN.A DET
 gava.
 cut.open
 ‘When the whale arrives, it is Dehegevaealigi who shall cut it open.’
- (136) De-laa ai, gai taholaa gu holo a Vave, gai ana dama, gilaadeu ga
 DET-DIST OBL then DET.whale INC swallow PN Vave then 3SG.GEN.A child 3PL PRSP
 aahe mai ai loo, gi de henua go Madalama.
 return.PL DIR.PROX OBL EMPH to DET island COP.FOC Madalama
 ‘And so, the whale swallowed Vave, and his children, they returned to the island of
 Madalama.’
- (137) Gai ga tau huu gilaadeu, gai gilaadeu gu doo de maduu.
 then PRSP arrive.PL when 3PL then 3PL INC drop DET mature.coconut
 ‘And when they arrived, they planted the mature coconut.’
- (138) Gai ga doo huu gilaadeu de maduu ga somo, ga lau valu huu, gai
 then PRSP drop when 3PL DET mature.coconut PRSP grow PRSP leaf eight when then
 gu dau taholaa.
 INC arrive DET.whale
 ‘And when they planted the mature coconut and it grew, when it had eight leaves, the
 whale arrived.’
- (139) Gai de masavaa huu ne dau ai taholaa, gai gilaadeu ga pasa, gai
 then DET time when PFV arrive OBL DET.whale then 3PL PRSP talk.PL then
 de-laadeu mee ne haga-modu i olaadeu daha, bolo e dee go
 DET-3PL.GEN thing PFV CAUS-stop PREP 3PL.GEN.O place COMP IPFV NEG COP.FOC
 Dehegevaealigi loo, e ohaa taholaa.
 Dehegevaealigi EMPH IPFV break.CIA DET.whale
 ‘When the whale arrived, they discussed it, and they agreed among themselves that it
 would not be Dehegevaealigi who would cut open the whale.’

- (140) Gai go Deagu e ohaa, go ia e madua.
 then COP.FOC Deagu IPFV break.CIA COP.FOC 3SG IPFV old
 'It would be Deagu who would cut it open, because he was older.'
- (141) De-laa ai de masavaa huu olaadeu ne hulo ai e ooha taholaa, gai
 DET-DIST OBL DET time when 3PL.GEN.O PFV go.PL OBL IPFV break.PL DET.whale then
 a Vave ga basa age i lote daholaa ga ssili age,
 PN Vave PRSP talk up PREP inside.det whale PRSP ask up
 'And so, when they came to cut open the whale, Vave spoke from inside the whale and
 asked.'
- (142) Be gu aha laa gilaadeu, gu hai gee ai laa ma ana muna?
 COMP.INT INC what DIST 3PL INC do away OBL DIST with 3SG.GEN.A word
 'Why have you done away with what I told you?'
- (143) E hai ange a Deagu gi a Vave,
 IPFV say DIR.DIST PN Deagu to PN Vave
 'Deagu said to Vave,'
- (144) De-maadeu mee ne haga-modu i omaadeu daha, de-nei oogu
 DET-1PL.EXCL.GEN thing PFV CAUS-stop PREP 1PL.EXCL.GEN.O place DET-PROX 1SG.GEN.O
 ne hai hegau ai nei, hidinga Dehegevaealigi, bolo e gauligi huu.
 PFV do work OBL PROX because Dehegevaealigi COMP IPFV young still
 'We have agreed that this is what I am doing, because Dehegevaealigi is still too young.'
- (145) Gai de muna o Vave ne basa ange ai, gai a Vave ga basa age i
 then DET word GEN.O Vave PFV talk DIR.DIST OBL then PN Vave PRSP talk up PREP
 lote mamu, go daholaa, ga hai ange,
 inside.DET fish COP.FOC whale PRSP say DIR.DIST
 'And the words that Vave spoke to them, Vave spoke from inside the fish, the whale, and
 said.'
- (146) E nnaa! De hagadoonunga o de muna nei, a Vave gu lodo baubau, ana
 DET meaning GEN.O DET word PROX PN Vave INC upset 3SG.GEN.A
 dama gu dee haga-llongo ange gi de ia.
 child INC NEG CAUS-listen DIR.DIST to DET 3SG
 'E nnaa! The meaning of this word is that Vave is upset, because his children didn't listen
 to him.'

- (147) De-nei ai, de hagaodi muna a Vave, be go de boolonga a Vave
 DET-PROX OBL DET CAUS-empty word GEN.A Vave or COP.FOC DET will GEN.A Vave
 ange, gi ana dama, i de-laadeu hai e hai hegau ai.
 DIR.DIST to 3SG.GEN.A child PREP DET-3PL.GEN way IPFV do work OBL
 ‘So then, the last words of Vave, or Vave’s will to his children, was about how they should
 do things.’

A.12 Taalanga o Vave (13-7) – Haini

Speaker: Haini

Date recorded: Spring 1966

Location: Nukuoro Atoll, Pohnpei State, Federated States of Micronesia

Recording information: Reel 13, story 7

Haini tells a second version of the story of Vave, including Gaeuli’s arrival on the island, the curse that keeps Vave and his family from making landfall, and Vave’s sacrifice to save his family. He also adds on several details from the story of Tailalahahaodengadubua, where two young men travel to bring back the spirit of the plants of Nukuoro.

- (1) Dahi daane, d-ono ingoo go Gaeuli.
 one man DET-3SG.GEN.O name COP.FOC Gaeuli
 ‘One man, his name was Gaeuli.’
- (2) Se dangada Saamoā.
 COP.SG person Samoa
 ‘He was a Samoan person.’
- (3) Gai ia ga malanga i Saamoā, ga hu-mai, ga hagamaga
 then 3SG PRSP depart PREP Samoa PRSP come.SG-DIR.PROX PRSP go.place.to.place
 mai, denga henua ga hu-mai ai.
 DIR.PROX DET.PL island PRSP come.SG-DIR.PROX OBL
 ‘He set sail from Samoa and came, and sailed from island to island and came.’
- (4) Gai ia ga hu-mai hu-mai hu-mai hu-mai
 then 3SG PRSP come.SG-DIR.PROX come.SG-DIR.PROX come.SG-DIR.PROX come.SG-DIR.PROX
 hu-mai, gu sula de henua nei.
 come.SG-DIR.PROX INC appear DET island PROX
 ‘So he sailed and sailed and sailed, and this island appeared.’

- (5) Gai ia ga hu-mai gu gidee e dahi ulu manu i dua Dagamanga.
 then 3SG PRSP come.SG-DIR.PROX INC see IPFV one dolphin PREP back Dagamanga
 ‘So he came and saw a dolphin on the ocean-side of Dagamanga.’
- (6) Gai ia ga tili de uga. Ga haangoda.
 then 3SG PRSP send DET fishing.line PRSP go.fishing
 ‘So he cast his fishing line and went fishing.’
- (7) Ga tili iho huu, gu gai dahi libo laanui sauua.
 PRSP send down when INC eat one jack big powerful
 ‘When he cast his line down, a big strong jack bit it.’
- (8) Gai ia ga hudi age.
 then 3SG PRSP pull up
 ‘So he pulled it up.’
- (9) Hhudi age ga hhao gi te moni gu maua, gai ia ga hu-mai.
 pull up PRSP put.into to inside.DET canoe INC be.able then 3SG PRSP come.SG
 ‘Pulled it up and managed to put it inside his canoe, and he came.’
- (10) Ga hu-mai hu-mai hu-mai ga hano ga hano iho
 PRSP come.SG-DIR.PROX come.SG-DIR.PROX come.SG-DIR.PROX PRSP go.SG PRSP go.SG down
 i de ava, ga hu-mai laa dai.
 PREP DET channel PRSP come.SG-DIR.PROX DIST lagoon
 ‘He sailed and sailed and went and went down through the channel, and came to the lagoon-side.’
- (11) Hu-mai hu-mai hu-mai, de hale e mua gi dai
 come.SG-DIR.PROX come.SG-DIR.PROX come.SG-DIR.PROX DET house IPFV front to lagoon
 i dai de henua nei, Langiasa.
 PREP lagoon DET island PROX Langiasa
 ‘He sailed and sailed by the house nearest to the lagoon on the lagoon-side of this island, Langiasa.’
- (12) Gai ia ga maanadu age, Aa, ga hano gi de hale nei e dunu ai
 then 3SG PRSP think up okay PRSP go.SG to DET house PROX IPFV cook OBL
 d-agu libo.
 DET-1SG.GEN.A jack
 ‘And he thought, Okay, I’ll go to this house to cook my jack.’

- (13) Gai ia ga han-age gi de hale laa.
 then 3SG PRSP go.SG-up to DET house DIST
 'So he went up to that house.'
- (14) Han-age ga daula de moni, gai ia ga gaav-age d-ana libo, ga han-age
 go.SG-up PRSP tie DET canoe then 3SG PRSP give-up DET-3SG.GEN.A jack PRSP go.SG-up
 ga dugu gai ia ga siga d-ana ahi, gu gaa, daamada nei
 PRSP put then 3SG PRSP create.spark DET-3SG.GEN.A bonfire INC catch.fire begin PROX
 de dahu d-ana ahi.
 DET build.fire DET-3SG.GEN.A bonfire
 'He went ashore and tied his canoe, and he took his jack, and went up and put it down
 and he started his fire and it caught, and began to build his fire.'
- (15) De masavaa ne daamada ai laa de dahu d-ana ahi gai ia ga
 DET time PFV begin OBL DIST DET build.fire DET-3SG.GEN.A bonfire then 3SG PRSP
 galo adu, ma-dala de moni ga dahea.
 look DIR.MED STAT-untie DET canoe PRSP drift
 'When he began to build his fire, he looked over, and his canoe had become untied and
 was drifting.'
- (16) Gai ia ga savini iho. Ga nnoa, ga dugu, gai ia ga ahe age.
 then 3SG PRSP run down PRSP tie PRSP put then 3SG PRSP return up
 'So he ran down. He tied it, placed it, and came back up.'
- (17) Dahu d-ana ahi. Dahu dahu dahu huu, gu gaa
 build.fire DET-3SG.GEN.A build.fire build.fire build.fire when when INC catch.fire
 d-ana ahi, gai ia ga dugu ange d-ana libo, gai ia ga
 DET-3SG.GEN.A bonfire then 3SG PRSP put DIR.DIST DET-3SG.GEN.A jack then 3SG PRSP
 noho ga dunu.
 sit PRSP cook
 'He built his fire. As he built it and built it, his fire caught, then he placed his jack on it
 and he sat and cooked it.'
- (18) Tigi huli d-ana libo ga galo adu, ma-dala de moni ma gu dahea.
 not.yet turn DET-3SG.GEN.A jack PRSP look DIR.MED STAT-untie DET canoe and INC drift
 'He hadn't yet turned over the jack when he looked and saw that the canoe was untied
 and had drifted.'

- (19) Gai ia ga ahe iho ga nnoa. Gai ia ga ahe age.
 then 3SG PRSP return down PRSP tie then 3SG PRSP return up
 'So he went back down and tied it. Then he returned up.'
- (20) Gai ia e dee iloo donu be ni aha aa-laa.
 then 3SG IPFV NEG know EMPH COMP.INT COP.PL what PL-DIST
 'He didn't know what was going on.'
- (21) Gu aha laa gu dagodo ai laa be laa d-ono moni.
 INC what DIST INC situation OBL DIST if DIST DET-3SG.GEN.O canoe
 'Why this was happening to his canoe.'
- (22) Han-age ia ga noho ga hai ana mee gai gu ma-dala.
 go.SG-up 3SG PRSP sit PRSP do 3SG.GEN.A thing then INC STAT-untie
 'He went up and sat and did his things and it was untied.'
- (23) D-agu bau go denga eidu o Sogo aa-laa.
 DET-1SG.GEN.A figure.out COP.FOC DET.PL ghost GEN.O Sogo PL-DIST
 'He realized it was Sogo's ghosts who did it.'
- (24) Go Sogo e hai ange gi denga gaibea, gi daalaa de moni gi dahea.
 COP.FOC Sogo IPFV say DIR.DIST to DET.PL crab SBJV untie.CIA DET canoe SBJV drift
 'It was Sogo who told the crabs to untie the canoe so it would drift away.'
- (25) Agai tangada nei tigi gidee donu e ia.
 then DET.person PROX not.yet see EMPH ERG 3SG
 'But this man had not yet seen them.'
- (26) Gai ia ga ahe ga nnoa, gai ia ga ahe age ga dunu d-ana mamu,
 then 3SG PRSP return PRSP tie then 3SG PRSP return up PRSP cook DET-3SG.GEN.A fish
 hai hai be laa ga huli de baasi laa ga dunu dunu ange, e hia e
 do do like DIST PRSP turn DET side DIST PRSP cook cook DIR.DIST IPFV how.many IPFV
 lima be ono hanonga ne dagodo ai be nei,
 five or six iteration PFV lay OBL like PROX
 'So he went back and tied it, and he came back up and cooked his fish, and continued like
 this and turned it to the other side and cooked it, and there were five or six times that it
 happened like this.'

- (27) oona ne savini ai be nei gi d-ono moni.
 3SG.GEN.A PFV run OBL like PROX to DET-3SG.GEN.O canoe
 ‘that he ran like this to his canoe.’
- (28) Gu mmoa d-ana mamu, gai ia gave iho, gai ia ga maanadu age,
 INC cooked DET-3SG.GEN.A fish then 3SG take down then 3SG PRSP think up
 ‘When his fish was cooked, he took it off, and he thought.’
- (29) Ga noho nei au e gai mee be ga hano nei.
 PRSP sit PROX 1SG IPFV eat thing or PRSP go.SG PROX
 ‘I could stay here to eat or I could leave.’
- (30) Aa, e dee iloo de noho. E dee iloo donu e au be ni aha
 okay IPFV NEG know DET sit IPFV NEG know EMPH ERG 1SG COMP.INT COP.PL what
 aa-nei.
 PL-PROX
 ‘I cannot stay. I don’t know what is happening.’
- (31) Ga hano? Au ga ahe nei donu e hano gi d-ogu henua.
 PRSP go.SG 1SG PRSP return PROX EMPH IPFV go.SG to DET-1SG.GEN.O island
 ‘Should I go? I will go back and go to my island.’
- (32) Gai ia ga hagenda d-ana libo, ga kave gi hongga d-ono moni, ga
 then 3SG PRSP put.on DET-3SG.GEN.A jack PRSP take to top DET-3SG.GEN.O canoe PRSP
 hano ai loo.
 go.SG OBL EMPH
 ‘So he put his jack on his shoulder and took it onto his canoe and left.’
- (33) Gai ia ga hano ai loo. Ga hano hano hano hano hano hano huu, gu dae,
 then 3SG PRSP go.SG OBL emph PRSP go.SG go.SG go.SG go.SG go.SG go.SG when INC reach
 ‘So he left. And he sailed and sailed and sailed and sailed until he reached it.’
- (34) gu dae gi Saamoā. Gai ia ga hai ange,
 INC reach to Samoa then 3SG PRSP say DIR.DIST
 ‘until he reached Samoa. And he said.’

- (35) E dahi henua aagu e gide, e deai donu dangada iai, gai se aha de
 IPFV one island 1SG.GEN IPFV see IPFV no EMPH person there then COP.SG what DET
 danuaa.
 beautiful
 ‘There’s an island that I found, there are no people there, and how beautiful it is.’
- (36) Agai e dee iloo donu be se aha de-nei, au ga han-age e dunu
 then IPFV NEG know EMPH if COP.SG what DET-PROX 1SG PRSP go.SG-up IPFV cook
 d-agu mamu, ga dahu de ahi, tigi gaa de ahi ga galo
 DET-1SG.GEN.A fish PRSP build.fire DET bonfire not.yet catch.fire DET bonfire PRSP look
 adu gu ma-dala de moni.
 DIR.MED INC STAT-untie DET canoe
 ‘But I don’t know what happened, I went up to cook my fish, and build my fire, and the
 fire had not yet caught and I looked and my canoe was untied.’
- (37) Gai au ga savini iho agina.
 then 1SG PRSP run down OBL
 ‘So I ran down to it.’
- (38) Gu gaa de ahi ga han-age au ga dunu d-agu libo tigi huli
 INC catch.fire DET bonfire PRSP go.SG-up 1SG PRSP cook DET-1SG.GEN.A jack not.yet turn
 de baasi laa, galo adu gu dahea, au ga ahe iho ga nnoa.
 DET side DIST look DIR.MED INC drift 1SG PRSP return down PRSP tie
 ‘The fire caught and I went up and cooked my jack and hadn’t yet flipped it to the other
 side, and I looked and it was drifting, I went down and tied it.’
- (39) De-laa ai, ga lima huu be ono hanonga ne hai ai be nei, gai au ga
 DET-DIST OBL PRSP five when or six iteration PFV do OBL like PROX then 1SG PRSP
 maanadu age,
 think up
 ‘And so, after five or six times that this happened, I thought.’

- (40) Se aha denei? Ga mmoa huu d-ana mamu, gai ia ga maanadu
 COP.SG what DET-PROX PRSP cooked when DET-3SG.GEN.A fish then 3SG PRSP think
 age gu dee noho donu i kinei, ga hano nei donu au e hano gee go
 up INC NEG sit EMPH PREP here PRSP go.SG PROX EMPH 1SG IPFV go.SG away COP.FOC
 ia e tala ange donu be nei gi tangada laa, gai ia go tangada
 3SG IPFV tell DIR.DIST EMPH like PROX to DET.person DIST then 3SG COP.FOC DET.person
 ga hai ange,
 PRSP say DIR.DIST
 ‘What is this?’ When his fish was cooked, he decided not to stay here, I will go and leave.
 He told this to that person (Vave) and he, the person, said.’
- (41) Ga loo-age loo gidaau.
 PRSP come.PL-up EMPH 1DU.INCL
 ‘We will go back.’
- (42) Ga loo-age loo gidaadeu ga aahe age gidaadeu e tilo taadeu henua,
 PRSP go.PL-up EMPH 1PL.INCL PRSP return.PL up 1PL.INCL IPFV look DET.1PL.INCL island
 ‘We will go up and return there to look for our island.’
- (43) e tilo d-au henua ne gide naa.
 IPFV look DET-2SG.GEN.A island PFV see MED
 ‘to look for the island that you found.’
- (44) Gai a Vave ga kave d-ono bodu, ma ana dama ma ono dangada
 then PN Vave PRSP take DET-3SG.GEN.O spouse and 3SG.GEN.A child and 3SG.GEN.O person
 o d-ono moni, gai ia donu go de balia nei ne ahe
 GEN.O DET-3SG.GEN.O canoe then 3SG EMPH COP.FOC DET navigator PROX PFV return
 mai donu.
 DIR.PROX EMPH
 ‘So Vave took his wife and his children and his people of his canoe, and him, the navigator
 who returned.’
- (45) E hai bodu ange gi luu damaa hine a Vave, go dogo-lua
 IPFV make spouse DIR.DIST to DET.DU child woman PN Vave COP.FOC CL.HUM-two
 ono bodu Gauna ma Hagalolo.
 3SG.GEN.O spouse Gauna and Hagalolo
 ‘He is married to the two daughters of Vave, his two wives Gauna and Hagalolo.’

- (46) Go luu damaa hine a Vave. Hai bodu ange agina tangada
 COP.FOC DET.DU child woman PN Vave make spouse DIR.DIST to.there DET.person
 go Gaeuli.
 COP.FOC Gaeuli
 'The two daughters of Vave. They were married to that man Gaeuli.'
- (47) Gilaadeu ga loo-mai ai loo.
 3PL PRSP come.PL-DIR.PROX OBL EMPH
 'So they came.'
- (48) Loo-mai loo-mai loo-mai, gu sula de henua,
 come.PL-DIR.PROX come.PL-DIR.PROX come.PL-DIR.PROX INC appear DET island
 loo-mai. Ga nnoho.
 come.PL-DIR.PROX PRSP live.PL
 'Sailed and sailed and sailed, the island appeared, and they came. And stayed there.'
- (49) Gilaadeu ga loo-mai huu ga nnoho ai i de henua nei, gai a
 3PL PRSP come.PL-DIR.PROX when PRSP live.PL OBL PREP DET island PROX then PN
 Sogo ga hu-mai.
 Sogo PRSP come.SG
 'As they came and lived on this island, Sogo came.'
- (50) A Sogo ga hu-mai, hu-mai ga hai ange gi a Vave,
 PN Sogo PRSP come.SG-DIR.PROX come.SG-DIR.PROX PRSP say DIR.DIST to PN Vave
 'Sogo came, came and said to Vave.'
- (51) Se hu-mai nei au e daudau gidaadeu ma oo daane.
 COP.SG come.SG-DIR.PROX PROX 1SG IPFV wrestle 1PL.INCL with 2SG.GEN.O man
 'I came to wrestle with you and your men.'
- (52) Ga kii naa huu oo daane, ni-oodou ai loo de henua.
 PRSP win IRR when 2SG.GEN.O man COP.PL-2PL.GEN OBL EMPH DET island
 'If your men win, the island will be yours.'
- (53) Gai ga kii naa huu au, ni-oogu ai loo de henua.
 then PRSP win IRR when 1SG COP.PL-1SG.GEN.O OBL EMPH DET island
 'But if I win, the island will be mine.'

- (54) Ga daudau huu, gu kii denga daane o Vave.
 PRSP wrestle when INC win DET.PL man GEN.O Vave
 'When they wrestled, Vave's men won.'
- (55) Gai a Sogo, ga llanga d-ana laulau, ga taa ana gelegele,
 then PN Sogo PRSP weave DET-3SG.GEN.A type.of.basket PRSP scoop.up 3SG.GEN.A sand
 ga hano ai.
 PRSP go.SG OBL
 'So Sogo wove his basket and scooped up some sand, and left with it.'
- (56) Gai ia ga hano gi ngaiho.
 then 3SG PRSP go.SG to north
 'And he went north.'
- (57) Ga hano gi ngaiho, gai e malili denga gelegele, de-naa ai, e daakodo ai
 PRSP go.SG to north then IPFV fall.out DET.PL sand DET-MED OBL IPFV lay.PL OBL
 naa dengaa modu e hulo naa gi ngaiho.
 MED DET.PL.SUP islet IPFV go.PL MED to north
 'As he went north, the sand fell out little by little, and so, the islands that go to the north
 lay there.'
- (58) Gai gilaadeu ga nnoho ai loo.
 then 3PL PRSP sit/stay OBL emph
 'So they stayed there.'
- (59) Ga nnoho nnoho huu gai dahi dangada angeange ga hu-mai hogi i
 PRSP live.PL live.PL when then one person other PRSP come.SG-DIR.PROX also PREP
 Saamoaa.
 Samoa
 'As they lived there for a while, another person came from Samoa.'
- (60) Ga hu-mai, ga hu-mai hogi ga hu-mai
 PRSP come.SG-DIR.PROX PRSP come.SG-DIR.PROX also PRSP come.SG-DIR.PROX
 hu-mai hu-mai hu-mai hu-mai, ga
 come.SG-DIR.PROX come.SG-DIR.PROX come.SG-DIR.PROX come.SG-DIR.PROX PRSP
 hu-mai ga dae mai gi ... gi hee ... gi Dahidi.
 come.SG-DIR.PROX PRSP reach DIR.PROX to to where to Tahiti
 'Came and came also, and sailed and sailed and sailed and arrived at... at where... at Tahiti.'

- (61) Ga lava gai ia ga hu-mai. Hu-mai gu dae mai gi
 PRSP finish then 3SG PRSP come.SG-DIR.PROX come.SG-DIR.PROX INC reach DIR.PROX to
 kinaa.
 there
 ‘Then he came. Came and reached there.’
- (62) Dae mai gi de henua nei.
 reach DIR.PROX to DET island PROX
 ‘Arrived at this island.’
- (63) Gai ia ga hu-mai, gu hu-mai ga hulihuli saele luu
 then 3SG PRSP come.SG-DIR.PROX INC come.SG-DIR.PROX PRSP turn.RED around DET.DU
 lima o Vave.
 arm/hand GEN.O Vave
 ‘So he came, came and turned Vave’s arms all around.’
- (64) Ga galo ange ga tilo ga tilo de angaanga ga han-ange gi
 PRSP look DIR.DIST PRSP search.for PRSP search.for DET body PRSP go.SG-DIR.DIST to
 luu lima o Vave, gai a Vave ga, Gu aha laa?
 DET.DU arm/hand GEN.O Vave then PN Vave PRSP INC what DIST
 ‘He looked over and inspected Vave’s body and his two arms, and Vave (said), What is it?’
- (65) Gai dee au ga hu-mai huu i Saamoa e hu-mai, ga
 then DET? 1SG PRSP come.SG-DIR.PROX when PREP Samoa IPFV come.SG-DIR.PROX PRSP
 galo age e dahi daane, de gau i Hidi e hagaduu e dahi laagau ma
 look up IPFV one man DET people PREP Tahiti IPFV CAUS-stand IPFV one log and
 e nnoa ma e dada gi lunga, gai ga dabudabui hongade baba, ga
 IPFV tie and IPFV pull to above then PRSP splash.water.RED top DET platform PRSP
 ula age de ahi, gai gilaadeu ga tili iho gi te ula, ga lava ga
 flame up DET bonfire then 3PL PRSP send down to inside.DET flame PRSP finish PRSP
 dada gi lunga, gai au ga galo ange, go oo dulagi donu huu.
 pull to above then 1SG PRSP look DIR.DIST COP.FOC 2SG.GEN.O appearance only
 ‘Well, when I came from Samoa, I saw a man. The people of Hidi erected a post and tied
 him to it and pulled him up, and splashed water on the platform and the fire flamed up,
 and then they cast him down into the flames, and then they pulled him back up, and I
 looked at him, and he looked just like you.’

- (66) Gai a Vave, Aa, go d-agu dama donu loo de-naa.
 then PN Vave okay COP.FOC DET-1SG.GEN.A child EMPH EMPH DET-MED
 ‘And Vave said,
 ‘Ah, that must be my son.’
- (67) Ga han-adu nei loo au e hano e tilo.
 PRSP go.SG-DIR.MED PROX EMPH 1SG IPFV go.SG IPFV search.for
 ‘I am going to go search for him.’
- (68) Ga lava, a Vave ga solo d-ono moni, ga dada de oo, gamai
 PRSP finish PN Vave PRSP drag DET-3SG.GEN.O canoe PRSP pull DET ration.of.taro bring
 ono dangada.
 3SG.GEN.O person
 ‘And so, Vave dragged his canoe to the shore, picked some taro, and brought his people.’
- (69) Ga hai ange, Ga hulo gidaadeu. Hulo tilo d-agu dama, made go
 PRSP say DIR.DIST PRSP go.PL 1PL.INCL go.PL look DET-1SG.GEN.A child thoughts COP.FOC
 d-agu dama de-nei.
 DET-1SG.GEN.A child DET-PROX
 ‘And he said, Let’s go. Go and look for my son, I think this is my son.’
- (70) Gilaadeu ga hulo, ga malanga huu i de henua nei ga hulo ga hulo hulo
 3PL PRSP go.PL PRSP depart when PREP DET island PROX PRSP go.PL PRSP go.PL go.PL
 hulo hulo, gu tau i Oneabu.
 go.PL go.PL INC arrive.PL PREP Oneop
 ‘They left, as they set sail from this island, they went and sailed and sailed and sailed and
 arrived at Oneop.’
- (71) Tau i Oneabu, ga lava ga malanga i Oneabu bolo ga malanga e
 arrive.PL PREP Oneop PRSP finish PRSP depart PREP Oneop COMP PRSP depart IPFV
 hulo gi Saamoa.
 go.PL to Samoa
 ‘Arrived at Oneop, and then they set sail from Oneop in order to go to Samoa.’
- (72) Gai ga malanga gai de lango e hakasa ai de moni ne ngalo.
 then PRSP depart then DET canoe.log IPFV CAUS.run.aground OBL DET canoe PFV forget
 ‘When they set sail, they left behind the log for bringing the canoe ashore.’

- (73) E dagodo donu huu i hongā de gelegele de henua o de gau laa.
 IPFV lay only PREP top DET sand DET island GEN.O DET people DIST
 'It was laying on the beach of the island of those people.'
- (74) Agai denga daane maadua ga loo-iho ga helau de lango.
 then DET.PL man old.PL PRSP come.PL-down PRSP do.magic DET canoe.log
 'So the old men came down and enchanted the log.'
- (75) Gai gilaadeu gu malanga ma gu hulo.
 then 3PL INC depart and INC go.PL
 'So they set sail and left.'
- (76) Ga hulo huu gilaadeu, doo gi de moana, ssoe ange gi de henua ga
 PRSP go.PL when 3PL drop to DET open.sea straight.PL DIR.DIST to DET island PRSP
 hulo e hulo gi de henua gai gu dee maua gi mau. Bau gu lava i
 go.PL IPFV go.PL to DET island then INC NEG be.able SBJV usual figure.out INC finish PREP
 de helau ma de labodo gu hano gi lote ama... de ama
 DET do.magic and DET eel INC go.SG to inside.DET outrigger.float DET outrigger.float
 de moni olaadeu.
 DET canoe 3PL.GEN.O
 'As they sailed and went out to the open sea straight toward the island, they went to go
 to the island, but they weren't able to. They realized that they did magic and the eel had
 gone into their outrigger float... the float of their canoe.'
- (77) Haga-mmahi de gau laa e hai loo-mai de labodo ga dada ga kave
 CAUS-strong DET people DIST IPFV do come.PL-DIR.PROX DET eel PRSP pull PRSP take
 gi de moana.
 to DET open.sea
 'Those people tried to come to the island, but the eel pulled them back to the open sea.'
- (78) Dee dau i denga henua ga hulo saele ai donu huu be laa ga hulo hulo
 NEG arrive PREP DET.PL island PRSP go.PL around OBL only like DIST PRSP go.PL go.PL
 hulo hulo hulo huu, gu odi gai de moni.
 go.PL go.PL go.PL when INC empty then DET canoe
 'They didn't reach any islands, they just sailed around like that, and as they sailed and
 sailed and sailed, they ran out of food on their canoe.'
- (79) Gai a Vave ga hai ange gi gilaadeu
 then PN Vave PRSP say DIR.DIST to 3PL
 'So Vave told them'

- (80) ga hano ia e dagodo i masavaa luu giado o de moni.
 PRSP go.SG 3SG IPFV lay PREP time DET.DU outrigger.boom GEN.O DET canoe
 'that he would go and lay in between the two boom poles of the canoe.'
- (81) Ga loo-mai dengaa mamu, gi huga o d-ono malo, gai
 PRSP come.PL-DIR.PROX DET.PL.SUP fish to thread GEN.O DET-3SG.GEN.O clothes then
 gilaadeu ga booboo ga gai.
 3PL PRSP grab.RED PRSP eat
 'And fish came to the threads of his clothes, and they caught them and ate them.'
- (82) Denga belubelu ma gina.
 DET.PL mackerel and rainbow.runner
 'Mackerels and rainbow runners.'
- (83) Gai ia ga hano kilaa... aa-laa ai olaadeu mee e gai mee ai.
 then 3SG PRSP go.SG there PL-DIST OBL 3PL.GEN.O thing IPFV eat thing OBL
 'He went there... those are the things that they ate.'
- (84) Gai ga hulo hulo hulo hulo huu gilaadeu, ga dee iloo nei donu be
 then PRSP go.PL go.PL go.PL go.PL when 3PL PRSP NEG know PROX EMPH COMP.INT
 ni aha e hai, gai a Vave ga hai ange gi Gaeuli.
 COP.PL what IPFV do then PN Vave PRSP say DIR.DIST to Gaeuli
 'And as they sailed and sailed and sailed, they didn't know what to do, so Vave said to Gaeuli.'
- (85) Haga-laango-na muhuu be aahee nei odaadeu dagodo, be dehee donu
 CAUS-listen-CIA please if how/which PROX 1PL.INCL.O lay COMP.INT which EMPH
 tagodo gai gidaadeu ga tau i dahi henua.
 DET.lay then 1PL.INCL PRSP arrive.PL PREP one island
 'Please listen to the oracle to see what is happening to us, and see how we can reach an island.'
- (86) Agai tangada laa ga buubuu ange huu, gu gidee.
 then DET.person DIST PRSP foresee DIR.DIST when INC see
 'So that man foretold, and saw it.'

- (87) Gu gidee ga magau naa a Vave, gai gilaadeu ga dau henua. Agai go
 INC see PRSP die IRR PN Vave then 3PL PRSP arrive island then COP.FOC
 gilaadeu naa huu e maakau, gai a Vave ga dau henua sogosogo.
 3PL IRR when IPFV die.PL then PN Vave PRSP arrive island alone
 ‘He saw that if Vave died, they would reach land. But if it was them that died, Vave would reach land alone.’
- (88) Agai e madagu i de tala ange.
 then IPFV afraid PREP DET tell DIR.DIST
 ‘But he was afraid to tell them.’
- (89) Agai gilaadeu ga hulo saele ai huu be nei ma de-laadeu hiikai nei
 then 3PL PRSP go.PL around OBL when like PROX and DET-3PL.GEN hunger.PL PROX
 ga hulo saele ai.
 PRSP go.PL around OBL
 ‘So they sailed around like this, going hungry, and they went on this way.’
- (90) Ga hulo hulo hulo hulo huu, gai taane laa ga ssili ange gi
 PRSP go.PL go.PL go.PL go.PL when then DET.man DIST PRSP ask DIR.DIST to
 lu-aana damaa hine,
 DET.DU-3SG.GEN.A child woman
 ‘As they sailed and sailed and sailed, that person (Vave) asked his two... his two daughters.’
- (91) Gooluu ssili ange muhuu gi d-ooluu bodu be tigi gidee laa loo e ia
 2DU ask DIR.DIST please to DET-2DU.GEN spouse if not.yet see DIST EMPH ERG 3SG
 de mee aagu ne hai ange laa ia gi diiloo. Gai luu dangada
 DET thing 1SG.GEN.A PFV say DIR.DIST DIST 3SG to search.for.CIA then DET.DU person
 laa ga ssili ange gai Gaeuli ga hai ange,
 DIST PRSP ask DIR.DIST then Gaeuli PRSP say DIR.DIST
 ‘Please ask your husband if he has foreseen the thing I told him to look for. So those two people asked him, and Gaeuli said,’
- (92) E hai mai d-agu buubuu bolo ga magau naa a Vave, gai gidaadeu
 IPFV do DIR.PROX DET-1SG.GEN.A divination COMP PRSP die IRR PN Vave then 1PL.INCL
 ga tau.
 PRSP arrive.PL
 ‘My divination foretold that if Vave dies, we will arrive.’

- (93) Gai go gidaadeu naa huu e maakau, gai a Vave ga dau sogosogo.
 then COP.FOC 1PL.INCL IRR when IPFV die.PL then PN Vave PRSP arrive alone
 ‘But if it is us who die instead, Vave will arrive alone.’
- (94) Agai dahi luu haahine laa ga tala ange gi a Vave.
 then one DET.DU woman DIST PRSP tell DIR.DIST to PN Vave
 ‘So one of those two women told this to Vave.’
- (95) Ga lango-na huu e Vave gai a Vave.
 PRSP hear-CIA when ERG Vave then PN Vave
 ‘When Vave heard this, he said,’
- (96) Aa, hai sala odi ai loo d-oodou ssenga.
 oh mistake empty OBL EMPH DET-2PL.GEN stupid
 ‘Oh, what a foolish mistake you made.’
- (97) Ga maakau gidaadeu gai goodou e dee haga-ago mai de mee naa.
 PRSP die.PL 1PL.INCL then 2PL IPFV NEG CAUS-learn DIR.PROX DET thing MED
 ‘We were about to die and you didn’t tell me this.’
- (98) Go au donu e danuaa d-ogu magau.
 COP.FOC 1SG EMPH IPFV good DET-1SG.GEN.O die
 ‘It is me who should die.’
- (99) Gai a Vave ga hai ange, Galo.
 then PN Vave PRSP say DIR.DIST look
 ‘Then Vave said, Look.’
- (100) Ga sobo age naa huu de laa daiao, goodou e gidee adu dahi mee gi
 PRSP rise up IRR when DET sun tomorrow 2PL IPFV see DIR.2 one thing to
 te laa.
 inside.DET sun
 ‘When the sun rises tomorrow, you will see something inside the sun.’

- (101) Gai de laa ga han-age han-age han-age han-age naa huu ga hu-mai
 then DET sun PRSP go.SG-up go.SG-up go.SG-up go.SG-up IRR when PRSP come.SG-DIR.PROX
 ga dae mai ga duu donu, agai taholaa gu lui mai i
 PRSP reach DIR.PROX PRSP stand EMPH then DET.whale INC turn.towards DIR.PROX PREP
 baasi gadea.
 side sail.side
 ‘And as the sun rises and rises and rises, it will come and arrive and be directly overhead,
 and the whale will come up next to the sail side of the canoe.’
- (102) Hanga e lui mai baasi gadea ma e hhang a de ngudu.
 split.open IPFV turn.towards DIR.PROX side sail.side and IPFV split.open DET mouth
 ‘It will come next to the sail side of the canoe and open its mouth.’
- (103) Agai ga haga-doo naa huu au ga hano gi te daholaa, agai goodou ga
 then PRSP CAUS-drop IRR when 1SG PRSP go.SG to inside.DET whale then 2PL PRSP
 hua mai dogu hagadubudubu.
 sing DIR.PROX DET-1SG.GEN.O praise
 ‘And when I drop into the mouth of the whale, you will sing my praises.’
- (104) Dee iloo be se mee be hee denei e hai nei se hagadubudubu
 NEG know if COP.SG thing if where DET-PROX IPFV do PROX COP.SG praise
 dagodo, be se me haga-boo laa be se aha.
 lay if COP.SG thing CAUS-night DIST or COP.SG what
 ‘I don’t know what kind of praises these are, whether it was a farewell or what.’
- (105) Ga lava, gai gilaadeu ga hulo ai loo ga dagodo be laa ga hulo hulo hulo
 PRSP finish then 3PL PRSP go.PL OBL EMPH PRSP happen if DIST PRSP go.PL go.PL go.PL
 huu, ga kalo adu gu sobo age gu ao de mee sobo age de laa, e
 when PRSP look.PL DIR.MED INC rise up INC daybreak DET thing rise up DET sun IPFV
 dahi mee e dagodo mai i lote laa.
 one thing IPFV lay DIR.PROX PREP inside.DET sun
 ‘And so, they went and stayed like that and sailed and sailed, and they looked and the sun
 rose and daybreak came, and there was something inside the sun.’

- (106) Gai gilaadeu ga hano hano hano huu ga dae gai gu lava donu de tala
 then 3PL PRSP go.SG go.SG go.SG when PRSP reach then INC finish EMPH DET tell
 ange a Vave ga duu donu naa huu, agai taholaa gu lui i baasi
 DIR.DIST PN Vave PRSP stand EMPH IRR when then DET.whale INC turn.toward PREP side
 gadea.
 sail.side
 ‘So they continued to sail and sail and reached there, and Vave had already told them that
 when the sun was directly overhead, the whale would be at the sail side of the canoe.’
- (107) Ga lava gai taholaa gu lui mai i baasi gadea, doo a Vave
 PRSP finish then DET.whale INC turn.toward DIR.PROX PREP side sail.side drop PN Vave
 ga han-ange, gilaadeu ga hua ange de mee nei, gai a Vave ga hai
 PRSP go.SG-DIR.DIST 3PL PRSP sing DIR.DIST DET thing PROX then PN Vave PRSP say
 ange,
 DIR.DIST
 ‘So then, the whale was facing them on the sail side of the canoe, and Vave dropped down,
 and they sang his praises, and Vave said,’
- (108) Galo. Hulo ai naa loo goodou ga loo-age, ga loo-age naa huu goodou,
 Look go.PL OBL IRR EMPH 2PL PRSP come.PL-up PRSP come.PL-up MED when 2PL
 gu dau henua i d-oodou henua.
 INC arrive island PREP DET-2PL.GEN island
 ‘Look. You will go and as you sail and sail, you will reach your island.’
- (109) D-oodou aahe age. Agai goodou ga doo de maduu.
 DET-2PL.GEN return.PL up then 2PL PRSP drop DET mature.coconut
 ‘When you return, you will plant the mature coconut.’
- (110) Ga doo naa huu ga lau valu, agai taholaa gu dau.
 PRSP drop IRR when PRSP leaf eight then DET.whale INC arrive
 ‘When you plant it and it has eight leaves, then the whale will arrive.’
- (111) Gai ga dau naa huu taholaa, agai e dee go tangada madua e
 then PRSP arrive IRR when DET.whale then IPFV NEG COP.FOC DET.person old IPFV
 hai-a, gai go tamaa gauligi i ana dama.
 do-CIA then COP.FOC DET.child young PREP 3SG.GEN.A child
 ‘And when the whale arrives, it will not be the oldest person who should cut it open, but
 the youngest of his children.’

- (112) Dee iloo e au i de tala adu de ingoo be go ai... ga lava
 NEG know ERG 1SG PREP DET tell DIR.MED DET name COMP.INT COP.FOC who PRSP finish
 gai gilaadeu ga loo-mai huu, gu dau henua gai gilaadeu ga doo
 then 3PL PRSP come.PL-DIR.PROX when INC arrive island then 3PL PRSP drop
 de maduu.
 DET mature.coconut
 ‘I can’t tell you the name of that person... then they sailed, and they made landfall and they planted the mature coconut.’
- (113) Ga doo huu de maduu, ga somo age ga dae gi de lau valu, gai gu
 PRSP drop when DET mature.coconut PRSP grow up PRSP reach to DET leaf eight then INC
 dau taholaa.
 arrive DET.whale
 ‘When they planted the coconut, it grew and reached eight leaves, and the whale had arrived.’
- (114) Ga dau huu taholaa, e bei donu muna a Vave ne tala ange laa.
 PRSP arrive when DET.whale IPFV like EMPH word GEN.A Vave PFV tell DIR.DIST DIST
 ‘When the whale arrived, it was just as Vave had told them.’
- (115) Gai gilaadeu ga loo-mai nei e hulo bolo e hulo e gaa-mai
 then 3PL PRSP come.PL-DIR.PROX PROX IPFV go.PL COMP IPFV go.PL IPFV bring-DIR.PROX
 e ssele taholaa.
 IPFV cut.open DET.whale
 ‘So they came and went to go and cut open the whale.’
- (116) Gai tama laa ga hai ange bolo go ia e hai-a.
 then DET.child DIST PRSP say DIR.DIST COMP COP.FOC 3SG IPFV do-CIA
 ‘And that child said he was the one who would do it.’
- (117) Gai a Vave ga basa age donu i lote manu,
 then PN Vave PRSP talk up EMPH PREP inside.DET animal
 ‘And Vave spoke from inside the whale.’
- (118) Gu aha gu hai gee ai naa ma d-agu hai-nga ne hai adu laa gi
 INC what INC do away OBL IRR with DET-1SG.GEN.A do-NMLZ PFV say DIR.MED DIST to
 goodou?
 2PL
 ‘Why have you done away with the way that I told you?’

- (119) Dee gu lava laa de tala adu tangada e hai-a? Gai gu aha laa goodou
 NEG INC finish DIST DET tell DIR.MED DET.person IPFV do-CIA then INC what DIST 2PL
 gu hai gee ai naa ma d-agu mee ne hai adu gi goodou?
 INC do away OBL IRR with DET-1SG.GEN.A thing PFV say DIR.MED to 2PL
 ‘Didn’t I tell you the person who should do it? So why have you done away with what I
 told you to do?’
- (120) De-laa tangada e hai-a de mamu.
 DET-DIST DET.person IPFV do-CIA DET fish
 ‘That’s the person who should cut open the fish.’
- (121) Ga lava ga haga-ahe ange gi tamaa gauligi gi hai-a de mamu, agai
 PRSP finish PRSP CAUS-return DIR.DIST to DET.child young SBJV do-CIA DET fish then
 a Vave, gu tee basa, gilaadeu ga ssele taholaa ga hai gu lava me,
 PN Vave INC PFV.NEG talk 3PL PRSP cut.open DET.whale PRSP do INC finish thing
 tamaa gauligi ne hai-a, gu lava, ga nnoho de gau nei.
 DET.child young PFV do-CIA INC finish PRSP live.PL DET people PROX
 ‘So then, they returned it to the youngest child to cut open the fish, then Vave stopped
 talking, and they cut open the whale and completed everything. The youngest child did
 it, and after they finished, these people stayed and stayed.’
- (122) Tae mai gi de henua nei, gai a Vave gu magau.
 reach.PL DIR.PROX to DET island PROX then PN Vave INC die
 ‘Reached this island, and Vave died.’
- (123) Gai a Vave gu magau.
 then PN Vave INC die
 ‘So Vave died.’
- (124) De-naa de momme aau ne hai naa. Gai muli mai huu, gai denga
 DET-MED DET place 2SG.GEN PFV do MED then behind DIR.PROX when then DET.PL
 hitegaiaa ga ... bolo go Vave ne haia de mee nei.
 demon PRSP say COP.FOC Vave PFV do.CIA DET thing PROX
 ‘That is what you’re saying. So later on, the *hitegaiaa* said that it was Vave who did this.’
- (125) Hai ange gi denga hitegaiaa gi loo-mai gi gaavee de hua bonga
 say DIR.DIST to DET.PL demon SBJV come.PL-DIR.PROX SBJV take.CIA DET fruit defective
 ma de mada baabaa.
 and DET cut.taro
 ‘said to the hitegaiaa to come and take the defective fruit and the cut taro.’

- (126) Gai de gau laa ga kave.
 then DET people DIST PRSP take
 'So they took them.'
- (127) Kave ga hulo ai. Ga sigosigo ga hulo ai.
 take PRSP go.PL OBL PRSP catch.RED PRSP go.PL OBL
 'Took them and left. Juggled them and left.'
- (128) Gai Iaigausema ma Daula ga loo-adu.
 then Iaigausema and Daula PRSP go.PL-DIR.MED
 'So Iaigausema and Daula went after them.'
- (129) Ga loo-adu loo-adu loo-adu huu gu dee vaa-hano a Daula.
 PRSP go.PL-DIR.MED go.PL-DIR.MED go.PL-DIR.MED when INC NEG be.able-go.SG PN Daula
 'They went and went and finally, Daula couldn't go any further.'
- (130) Ga noho i hongahadu dagi-dahi.
 PRSP sit PREP top stone each-one
 'They each sat on a stone.'
- (131) Gu dee vaa-hano donu gu vvela mai donu be se ahi.
 INC NEG be.able-go.SG EMPH INC hot DIR.PROX EMPH like COP.SG fire
 'He couldn't go any further because it was so hot, like a fire.'
- (132) Agai Iaigausema ga haga-lilo i ono bouli gee, han-adu ai ga
 then Iaigausema PRSP CAUS-disappear PREP 3SG.GEN.O spirit away go.SG-DIR.MED OBL PRSP
 hano.
 go.SG
 'So Iaigausema disappeared into an alternate dimension, and kept following them.'
- (133) Ga hano ga hano, ga sigosigo sigosigo gu dae mai de me laa ga
 PRSP go.SG PRSP go.SG PRSP catch.RED catch.RED INC reach DIR.PROX DET thing DIST PRSP
 hhao gi lot-ono malo huna.
 put.in to inside.DET-3SG.GEN.O loincloth
 'He went and went, and threw and caught and that thing reached him, and he put in inside
 his loincloth.'

- (134) Gai gilaadeu ga hulo ai loo.
 then 3PL PRSP go.PL OBL EMPH
 ‘And they left.’
- (135) Dige mai de lua, gai ia ga hhao gi lote malo huna, gai ia ga
 rotate DIR.PROX DET two then 3SG PRSP put.in to inside.DET loincloth then 3SG PRSP
 haga-lilo gi ono bouli gee, ga ahe mai, gaa-mai a Daula
 CAUS-disappear to 3SG.GEN.O spirit away PRSP return DIR.PROX bring-DIR.PROX PN Daula
 ga loo-mai ai gilaaau.
 PRSP come.PL-DIR.PROX OBL 3DU
 ‘On the second round, he grabbed it and put it inside his loincloth, and then he disap-
 peared into his alternate dimension and returned, and he brought Daula and they left.’
- (136) Ga loo-mai ga tae mai, ga doo de hua bongga i de
 PRSP come.PL-DIR.PROX PRSP reach.PL DIR.PROX PRSP drop DET fruit defective PREP DET
 guuduma a de bongga e velo laa gi ngaage i lodo Gausema.
 taro.bog.hill GEN.A DET defective IPFV stab DIST to south PREP inside Gausema
 ‘They came and reached the island, and they planted the defective fruit in the hillock that
 is pointing directly to the south at the inside of Gausema.’
- (137) Agai de mada baabaa ga doo i lote husi.
 then DET face flat PRSP drop PREP inside.DET taro.patch
 ‘And the cut taro was planted in the taro patch.’
- (138) Loo-age huu ga ssomo i de hanonga nei, ga hhua dengaa
 come.PL-up when PRSP grow.PL PREP DET iteration PROX PRSP fruit.PL DET.PL.SUP
 nui ga ssomo denga bulaga i te husi i Hale gu
 coconut.tree PRSP grow.PL DET.PL swamp.taro PREP inside.DET taro.patch PREP house INC
 ssomo, gai tangada nei gu dae donu gi ono henua.
 grow.PL then DET.person PROX INC reach EMPH to 3SG.GEN.O island
 ‘And when they grew again, the coconut trees bore fruit and the taro grew in the taro
 patch on the main islet, and this person got back to his island.’
- (139) Tangada go Ssamouli nei. Gai ia ga maanadu age,
 DET.person COP.FOC Ssamouli PROX then 3SG PRSP think up
 ‘This person Ssamouli. And he thought,’

- (140) Gu odi loo, de henua i Hale de maakau, ga ahe age nei loo au
 INC empty emph DET island PREP house DET die.PL PRSP return up PROX emph 1SG
 e tilo d-ogu henua.
 IPFV look DET-1SG.GEN.O island
 ‘The people on the main islet died already, so I will go back to find my island.’
- (141) Gai ia ga hu-mai. Ga hu-mai laa huu ga dae mai,
 then 3SG PRSP come.SG-DIR.PROX PRSP come.SG-DIR.PROX DIST when PRSP reach DIR.PROX
 bollaa, ga dae laa de henua i Hale, gu kohu adu de henua
 WOW PRSP reach DIST DET island PREP house INC growing.well DIR.MED DET island
 dengaa nui gu llui gi lalo gai ia deai ange se dangada i
 DET.PL.SUP coconut.tree INC turn.PL to below then 3SG no DIR.DIST COP.SG person PREP
 de au go Iaigausema loo de-nei.
 DET 1SG COP.FOC Iaigausema EMPH DET-PROX
 ‘So he came. As he came and reached here, wow, he reached the main islet, the island
 was growing well, and the coconut trees were heavy with fruit, and he thought, there is
 nobody but Iaigausema who could have done this.’
- (142) Gai ia ga hu-mai.
 then 3SG PRSP come.SG
 ‘So he came.’
- (143) Hu-mai hu-mai hu-mai, ga han-age i ngaadai
 come.SG-DIR.PROX come.SG-DIR.PROX come.SG-DIR.PROX PRSP go.SG-up PREP lagoon.side
 Saavae, e duu iho i bido i dai de hale hai daumaha.
 Saavae IPFV stand down PREP piece PREP west DET house do church
 ‘Then he came and came and came, and landed at the lagoon-side of Saavae, and stood on
 the shore by the house where they worshipped.’
- (144) Gai gu basa age loo,
 then INC talk up EMPH
 ‘And he said,’
- (145) Aa, gu duu loo goe e tama iai i doo duu-langa, gai tangada
 ah INC stand EMPH 2SG IPFV DET.child have PREP 2SG.GEN.O stand-NMLZ then DET.person
 laa ga hai ange.
 DIST PRSP say DIR.DIST
 ‘Ah, now you are standing in your rightful position.’ And that person (Iaigausema) said,’

- (146) Deai, go koe donu ni-oou tuulanga nei gai au se duu
 no COP.FOC 2SG EMPH COP.PL-2SG.GEN.O DET.stand-NMLZ PROX then 1SG COP.SG stand
 donu huu e hai ai mee, hai dagodo-nga o dengaa aligi.
 EMPH when IPFV do OBL thing do lay-NMLZ GEN.O DET.PL.SUP priest
 ‘No, this position is yours, I am only occupying it to perform the ritual of the priests.’
- (147) Hu-mai loo gi d-oo duu-langa.
 come.SG-DIR.PROX EMPH TO DET-2SG.GEN stand-NMLZ
 ‘Come to your position.’
- (148) Ga lava, de-naa ai, gu dae mai gi kinaa, gu odi de momme naa.
 PRSP finish DET-MED OBL INC reach DIR.PROX to there INC empty DET place MED
 ‘So then, that’s how it was, we’ve reached the end of that part of the story.’
- (149) Gu de-nei de hodoologi o denga hodoologi alodahi hugadoo i henua i
 INC DET-PROX DET king GEN.O DET.PL king all above.all PREP island PREP
 lalo ma ono ... go ia hugadoo e mao lunga i denga eidu
 below and 3SG.GEN.O COP.FOC 3SG all IPFV high-ranking PREP DET.PL ghost
 alodahi hugadoo.
 all above.all
 ‘So this is the king of all of the kings of the world, and he is above each and every ghost.’
- (150) E hulo hugadoo dangada gi kinei ga haga-tuu ange agina mee laa.
 IPFV go.PL above.all person to here PRSP CAUS-stand.PL DIR.DIST OBL thing DIST
 ‘Every person must come to him before they do anything.’
- (151) Tangada aau e hai mai naa go Iaidelangi.
 DET.person 2SG.GEN IPFV say DIR.PROX MED COP.FOC Iaidelangi
 ‘The person that you are telling me is Iaidelangi.’
- (152) Iaigausema ma Vave e hai hegau nei i henua i lalo.
 Iaigausema and Vave IPFV do work PROX PREP island PREP below
 ‘Iaigausema and Vave are doing things on earth.’
- (153) Go Iaigausema donu ma Vave baa, ma Vave go Samouli laa d-ono
 COP.FOC Iaigausema EMPH and Vave dad and Vave COP.FOC Samouli DIST DET-3SG.GEN.O
 ingoo.
 name
 ‘It is Iaigausema and father Vave, and Vave whose name is Samouli.’

- (154) Ga lava ga hulo ga hulo gi de langi ga hulo ga tae gi de langi, gai
 PRSP finish PRSP go.PL PRSP go.PL to DET sky PRSP go.PL PRSP reach.PL to DET sky then
 tangada laa ga hai ange,
 DET.person DIST PRSP say DIR.DIST
 ‘So then they went and went to the sky, and when they reached the heavens, that person
 said.’
- (155) Gooluu aahe iho hai-a ooluu hegau.
 2DU return.PL down do-CIA 2DU.GEN work
 ‘You two, go back down and do your work.’
- (156) Gooluu e he-dae donu huu. Dahi gooluu ne luei, gai dahi ne holo.
 2DU IPFV RCPR-meet only one 2DU PFV spit.out then one PFV swallow
 ‘You two are even with each other. One is to spit out, and the other is to swallow.’
- (157) Ga lava gai gilaau ga aahe iho gu dee maua e gilaau de hai gee
 PRSP finish then 3DU PRSP return.PL down INC NEG be.able ERG 3DU DET do away
 ange hanu mee ma de mee a de-laau dangada ne haga-modu ange,
 DIR.DIST some thing and DET thing GEN.A DET-3DU.GEN person PFV CAUS-decide DIR.DIST
 gilaau ga loo-iho ga nnoho ai.
 3DU PRSP come.PL-down PRSP live.PL OBL
 ‘So then, they returned down, and they could not do anything other than what that person
 commanded them to do, so they came down and stayed there.’
- (158) Dee iloo ai loo e au be ahee ange hanu hegau angeange gi muli mai
 NEG know OBL EMPH ERG 1SG if which DIR.DIST some work other to behind DIR.PROX
 ange alaau ne hai hegau ai ga hai hegau ga dae ai gi hongade
 DIR.DIST 3DU.GEN.A PFV do work OBL PRSP do work PRSP reach OBL to top DET
 masavaa de haga-odi o taalanga laanui.
 time DET CAUS-empty GEN.O DET.story big
 ‘I don’t know what else they did thereafter, what they did until the end of the larger story.’
- (159) Koe ga haga-llongo ai i daho hanu dangada be dehee.
 2SG PRSP CAUS-listen OBL PREP place.GEN some person COMP.INT which
 ‘You can hear from other people what happened.’